

# TRUGLO®

WHEN BRIGHTNESS COUNTS™



ARCHERY / CROSSBOW 2017

# TABLE OF CONTENTS

## BOW SIGHTS

### MULTI-PIN SIGHTS

<b>NEW</b> HYPER•STRIKE™	4-5
<b>NEW</b> CARBON•HYBRID™ MICRO	6-7
CARBON XS™ XTREME	8-9
STORM™	10
CARBON XS™	11
TSX™ PRO SERIES	11
RITE•SITE™ XS	12
BRITE•SITE™ XTREME	12

### SINGLE-PIN SIGHTS

<b>NEW</b> ARCHER'S CHOICE® RANGE•ROVER™ PRO	13
ARCHER'S CHOICE® RANGE•ROVER™ SERIES	14-15
PENDULUM SERIES	16

## ARROW RESTS

<b>NEW</b> LOCK•FIRE™	18-19
UP•DRAFT™	20
DOWN•DRAFT™	21
CARBON XS™	22
STORM™	23

## RELEASES

<b>NEW</b> ACTIVATOR™	25
<b>NEW</b> NITRUS™	26
<b>NEW</b> DETONATOR™	27
TRU•FIT™ BOA® RELEASE STRAP	28
SPEED SHOT™ XS	29

## QUIVERS

<b>NEW</b> TRU•TEC™ LT	31
CARBON XS™	32
LOC•DOWN™	33
TUFF•LOC™	34

## STABILIZERS

TRU•TEC™ CARBON PRO	36
<b>NEW</b> CARBON XS™	37
DEADENATOR™	38

## BROADHEADS

<b>NEW</b> TITANIUM X™ BROADHEADS	40-41
<b>NEW</b> TITANIUM X™ CROSSBOW BROADHEADS	42

## BOW ACCESSORIES

<b>NEW</b> BOW•JACK™	44
GREEN LED BOW LIGHT	45
BOW ACCESSORY MOUNT	45
<b>NEW</b> DUAL STABILIZER MOUNT	46
CENTRA™ SLING PRO	46
CENTRA™ SLING	46
BOW ACCESSORY KIT	46
PEEP SIGHTS	46
PEEP SILICONE TUBING	47
REPLACEMENT FIBERS & PINS	48
<b>NEW</b> BOW SIGHT LIGHTS	49
ARROW PULLER	50
TRU•BLOCK™ STRING SILENCERS	50
REPLACEMENT BATTERIES	50
TRU•BRITE™ BINOCULARS	51

## CROSSBOW OPTICS & ACCESSORIES

### CROSSBOW SCOPES

COMPACT 4x32MM	53
CROSS•TEC™ 4x32MM	54

### CROSSBOW DOT OPTICS

TRITON™ 30MM TRI•COLOR	55
TRADITIONAL 30MM RED•DOT	55
DUAL•COLOR OPEN RED DOT	56

### CROSSBOW ACCESSORIES

<b>NEW</b> HIP•SHOT™ CROSSBOW SHOOTING REST	57
<b>NEW</b> CROSSBOW BOLT PULLER	58
CROSS•TEC™ STRING SILENCERS	58
REPLACEMENT BATTERIES	58

## BOWFISHING

<b>NEW</b> SPEED•SHOT™ BOWFISHING ARROW	60
SPRING•SHOT™ BOWFISHING ARROW REST	61
SPRING•SHOT™ BOWFISHING KIT	61
ACCU•X™ BOWFISHING ARROW REST	62
BOWFISHING NOCKS	62
STRING FINGER GUARDS	62
BOWFISHING SLIDES, STOPS, & NOCKS	63
SPEED•SHOT™ POINT	63
SPEED•SHOT™ REPLACEMENT TIPS	63



# BOW SIGHTS

Bright multi-pin and single-pin sights — providing accuracy and versatility to modern hunting bows.



**NEW**

# HYPER•STRIKE™

ULTRA-LIGHT, LONG-RANGE BOW SIGHT

4

BOW SIGHTS



Long-range precision alignment and torque reduction.

*New for 2017, HYPER•STRIKE™ combines fan-favorite features with brand new innovations in the world of bow sights. Decreasing Diameter Pins increase your effective range, while the new TRU•LITE™ PRO rotary light illuminates your pins to extend your hunt through crucial low-light prime-time. The MAXAMOUNT™ bracket provides more setup options than ever before while the available SIGHTLINE™ system assists in lining up long-range shots while monitoring and perfecting shooting technique.*



**NEW**

5-Pin - Black  
**TG5405SB**



## PRODUCT FEATURES

- Lightweight carbon-composite and aluminum construction
- SIGHTLINE™ system (Model TG5405SB) for long-range precision, alignment and torque reduction
- Micro-adjustable windage and elevation
- 2nd and 3rd axis adjustable level
- Extra-long fibers for maximum brightness
- Large circular field of view (1.9 in. dia.)
- Decreasing Diameter Pin design uses smaller pins for longer distances
- MAXAMOUNT™ bracket offers three sight radius positions with high / low mounting holes for numerous mounting options
- Glow-in-the-dark shooter's ring
- Adjustable for left and right-handed shooters
- TRU•TOUCH™ soft-feel technical coating
- Patented



### Decreasing Diameter Pin Design

With smaller pin sizes for longer distances, the patented DDP™ design blocks less of the target, resulting in more precise pin placement and more accurate aiming.

TRUGLO® ARCHERY / CROSSBOW 2017





**PRO•BRITE™**  
PIN TECHNOLOGY



**MAXAMOUNT™**

Three sight radius positions with high / low mounting holes for numerous mounting options.

**TRU•LITE™ PRO Included**

NEW for 2017, TRU•LITE™ PRO (TG57) gives you more pin illumination options with 3 brightness levels controlled by positive twist-click knob. See page 49 for details.



**NEW**  
5-Pin - LOST® XD  
**TG5405M**

MODEL SPECS

MODEL	PINS	FINISH	CONSTRUCTION	LIGHT	LEVEL	APERTURE DIAMETER	WINDAGE / ELEVATION	TRU•TOUCH™
<b>NEW</b> TG5405SB	DDP™ 5 (3x.019" / 2x.010" dia.)	Black	Lightweight carbon composite and aluminum construction	NEW TRU•LITE™ PRO Rotary Light	Adjustable Level with SIGHTLINE™ long-distance alignment system	1.9 in.	Ultra-fine click adjustment	Yes
<b>NEW</b> TG5405B		LOST® XD			Adjustable 2nd and 3rd axis			
<b>NEW</b> TG5405M		Realtree™ XTRA™						
<b>NEW</b> TG5405J								

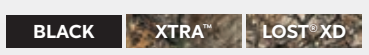

- MICRO ADJUST
- LARGE CIRCULAR FIELD OF VIEW
- GLOW-IN-THE-DARK SHOOTER'S RING
- DECREASING DIAMETER PIN DESIGN
- PRO•BRITE PIN TECHNOLOGY
- LIGHT INCLUDED



**NEW**

# CARBON HYBRID™ MICRO

LIGHTWEIGHT CARBON / ALUMINUM HYBRID BOW SIGHT

6

BOW SIGHTS

**PRO•BRITE™**  
PIN TECHNOLOGY

With TRU•FUSION™ Hybrid Technology, CARBON HYBRID™ Micro is the first and only micro-adjustable bow sight constructed with the optimum combination of carbon composites and aluminum, providing an excellent strength-to-weight ratio and unparalleled durability. Featuring PRO•BRITE™ Pin Technology, CARBON HYBRID Micro is the new standard for ultra-lightweight, multi-pin, micro-adjustable bow sights.



5-Pin Micro - Black  
**TG7515B**



## PRODUCT FEATURES

- Lightweight carbon-composite and aluminum construction
- Hybrid construction transfers less vibration
- Micro-adjustable / tool-less design
- Unique PRO•BRITE™ pin design for increased durability and brightness
- Extra-long fibers for maximum brightness
- Extra-long bracket increases sight radius
- Reversible bracket for increased vertical adjustment range
- For both left and right-handed shooters
- TRU•TOUCH™ Soft-Feel Technical Coating
- Patent pending

### Push-Button LED Included

Removable violet push-button sight light.



TRUGLO® ARCHERY / CROSSBOW 2017





**TRU•FUSION™**  
HYBRID TECHNOLOGY

TRUGLO® TRU•FUSION™ Hybrid Technology combines a carbon composite and aluminum construction, creating a durable, ultra-lightweight sight that can't be matched.

5-Pin - Black  
**TG7415B**



**NEW**  
5-Pin Micro - LOST® XD  
**TG7515M**



MODEL SPECS

MODEL	PINS	FINISH	CONSTRUCTION	LIGHT	LEVEL	APERTURE DIAMETER	WINDAGE / ELEVATION	TRU•TOUCH™
<b>TG7415B</b>	5 (5x.019" dia.)	Black	Lightweight carbon composite and aluminum	Removable push-button LED - violet	Adjustable 2nd and 3rd axis	1.9 in.	Standard adjustment	Yes
<b>TG7515B</b>		LOST® XD					Micro-adjustable	
<b>TG7515M</b>							Realtree™ XTRA™	
<b>TG7515J</b>								

**NEW**

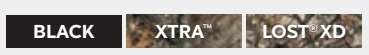

- ULTRA LIGHTWEIGHT
- MICRO ADJUST
- LARGE CIRCULAR FIELD OF VIEW
- GLOW-IN-THE-DARK SHOOTER'S RING
- PRO•BRITE PIN TECHNOLOGY
- LIGHT INCLUDED



# CARBON XS™ XTREME

ULTRA-LIGHTWEIGHT, CARBON-COMPOSITE BOW SIGHTS

8

BOW SIGHTS

**PRO•BRITE™**  
PIN TECHNOLOGY

*You asked, we listened. CARBON XS™ Xtreme is the next generation carbon composite bow sight for any aspiring bowhunter. We added more shooter-suggested features than ever before, including a longer mounting bracket, extended windage and elevation adjustments, larger aperture and PRO•BRITE™ Pin Technology for even brighter pins. With a little bit of everything, CARBON XS Xtreme is the go-to sight for any bowhunter, at any skill level.*



5-Pin - Black  
**TG5805B**



## PRODUCT FEATURES

- Ultra-lightweight carbon-composite construction - weighs less than 4.2 oz.
- Unique PRO•BRITE™ pin design for increased durability and brightness
- TRU•FLO™ Fiber Design
- Extra-long fibers for maximum brightness
- Reversible bracket for greater vertical adjustability
- Adjustable for left and right-handed shooters
- Glow-in-the-dark shooter's ring for improved peep alignment
- TRU•TOUCH™ Soft-Feel Technical Coating

### Push-Button LED Included

Removable violet push-button sight light.



TRUGLO® ARCHERY / CROSSBOW 2017





**TRU-FLO™**  
FIBER DESIGN

Maximizes light transmission to pins and eliminates glare from the LED light.

5-Pin - Black  
**TG5805B**



5-Pin - XTRA™  
**TG5805J**



## MODEL SPECS

MODEL	PINS	FINISH	CONSTRUCTION	LIGHT	LEVEL	APERTURE DIAMETER	WINDAGE / ELEVATION	TRU-TOUCH™
<b>TG5805B</b>	TRU-FLO™ Fiber Design 5 (5x.019" dia.)	Black	Ultra-lightweight carbon composite	Removable push-button LED - violet	High-visibility	1.9 in.	Standard adjustment	Yes
<b>TG5805F</b>		LOST AT®						
<b>TG5805J</b>		Realtree™ XTRA™						
<b>TG5805P</b>		Realtree™ APC™ PINK						

BLACK

XTRA™

LOST AT®

APC™ PINK

ULTRA  
LIGHTWEIGHT

LARGE CIRCULAR  
FIELD OF VIEW

GLOW-IN-THE-DARK  
SHOOTER'S RING

PRO-BRITE  
PIN TECHNOLOGY

LIGHT  
INCLUDED



# STORM™

ULTRA-LIGHTWEIGHT, COMPACT BOW SIGHTS

10

BOW SIGHTS

**PRO•BRITE™**  
PIN TECHNOLOGY



TG3013



TG3014



TG3015

### Adjustable Brightness LED

(Included on model TG3015B) TRU•LITE™ XTREME (TG56) removable violet rheostat LED sight light. See page 49 for details.



Ultra-lightweight STORM™ provides incredible performance at an attractive price. Available in 3, 4, or 5-pin models, STORM features incredibly bright PRO•BRITE™ Pin Technology, a large aperture, and durable CNC-machined aluminum construction, making it one of the best value sights in the TRUGLO® lineup.



5-Pin - Black  
**TG3015B**

## PRODUCT FEATURES

- Lightweight and compact
- Unique metal pin design for increased durability and brightness
- Enlarged circular field of view
- Adjustable for left and right-handed shooters

### What is TFO?

TFO® refers to our patented combination of Tritium and Fiber-Optic technologies. The Tritium maintains the brightness level of the sight in low-light (or NO light) conditions. That means you can see your sight even in complete darkness with perfect transition through all lighting conditions. Tritium does not need batteries and does not need to be charged with light – it simply glows!

## MODEL SPECS

MODEL	PINS	FINISH	CONSTRUCTION	LIGHT	LEVEL	APERTURE DIAMETER	WINDAGE / ELEVATION
TG3013B	3 (3x.019" dia.)	Black	CNC-machined aluminum	Sold separately	High-visibility	2 in.	Standard adjustment
TG3014T	4 (3x.019" dia., TFO® 1x.029" dia.)			Removable adjustable rheostat LED - violet			
TG3015B	5 (5x.019" dia.)						

**BLACK**



ULTRA  
LIGHTWEIGHT

LARGE CIRCULAR  
FIELD OF VIEW

GLOW-IN-THE-DARK  
SHOOTER'S RING

PRO•BRITE  
PIN TECHNOLOGY

TRUGLO® ARCHERY / CROSSBOW 2017



# CARBON XS™

LIGHTWEIGHT, CARBON-COMPOSITE BOW SIGHTS



Maximizes light transmission to pins and eliminates glare from the LED light.

TG5704

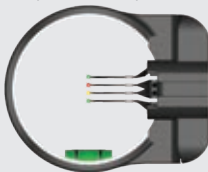

4-Pin - APG™  
TG5704C



- Ultra-lightweight carbon-composite construction – weighs less than 3.5 oz.
- TRU-FLO™ Fiber Design
- Extra-long, fully-protected fibers
- Reversible bracket for greater vertical adjustability
- Adjustable for left and right-handed shooters
- TRU-TOUCH™ Soft-Feel Technical Coating

### Push-Button LED Included

Removable violet push-button sight light.



## MODEL SPECS

MODEL	PINS	FINISH	CONSTRUCTION	LIGHT	LEVEL	APERTURE DIAMETER	WINDAGE / ELEVATION	TRU-TOUCH™
TG5704B	TRU-FLO™ Fiber Design 4 (4x0.19" dia.)	Black	Ultra-lightweight carbon composite	Removable push-button LED - violet	High-visibility	1.8 in.	Standard adjustment	Yes
TG5704C		Realtree™ APG™						
TG5704F		LOST AT®						
TG5704P		Realtree™ APC™ Pink						



ULTRA LIGHTWEIGHT

LARGE CIRCULAR FIELD OF VIEW

GLOW-IN-THE-DARK SHOOTER'S RING

CARBON-COMPOSITE CONSTRUCTION



# TSX™ PRO SERIES

BASED ON THE AWARD-WINNING TRU-SITE™ XTREME SERIES

- Based on the original award-winning TRU-SITE™ Xtreme Series
- Micro-adjustable / tool-less design
- Unique stainless steel tube pin design for increased durability and brightness
- Ultra-strong, lightweight construction
- Reversible bracket for greater vertical adjustability
- Adjustable for left and right-handed shooters
- TRU-TOUCH™ Soft-Feel Technical Coating

5-Pin - Black  
TG7315B



3-PIN



5-PIN

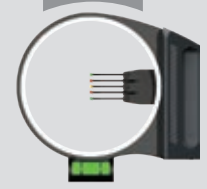

### Adjustable Brightness LED

TRU-LITE™ XTREME (TG56) removable violet rheostat LED sight light. See page 49 for details.



## MODEL SPECS

MODEL	PINS	FINISH	CONSTRUCTION	LIGHT	LEVEL	APERTURE DIAMETER	WINDAGE / ELEVATION	TRU-TOUCH™
TG7113B	3 (3x0.19" dia.)	Black	CNC-machined aluminum	Removable adjustable rheostat LED - violet	Adjustable 2nd and 3rd axis	2 in.	Standard adjustment Tool-less Micro-adjustable	Yes
TG7115B	5 (5x0.19" dia.)							
TG7215B								
TG7315B								

BLACK



MICRO ADJUST

TOOL-LESS DESIGN

LARGE CIRCULAR FIELD OF VIEW

GLOW-IN-THE-DARK SHOOTER'S RING

STAINLESS STEEL TUBE PIN DESIGN

LIGHT INCLUDED



# RITE•SITE™ XS

LIGHTWEIGHT, CARBON-COMPOSITE BOW SIGHTS

12

BOW SIGHTS

- Unique pin design increases brightness
- Removable rheostat light
- Ultra-durable construction
- Ultra-strong, lightweight pin guard
- Markings for elevation and windage
- Adjustable for left and right-handed shooters

5-Pin - Black  
**TG3515B**

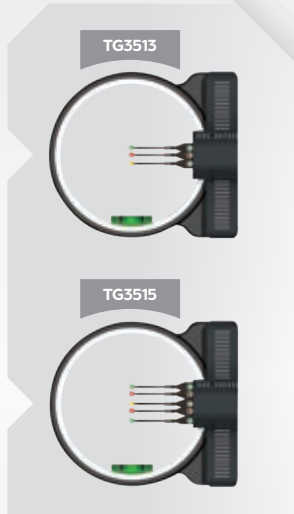

### Adjustable Brightness LED

TRU•LITE™ XTREME (TG56) removable violet rheostat LED sight light.  
See page 49 for details.



## MODEL SPECS

MODEL	PINS	FINISH	CONSTRUCTION	LIGHT	LEVEL	APERTURE DIAMETER	WINDAGE / ELEVATION
<b>TG3513B</b>	3 (3x.019" dia.)	Black	CNC-machined aluminum	Removable adjustable rheostat LED - violet	High-visibility	2 in.	Standard adjustment
<b>TG3515B</b>	5 (5x.019" dia.)						

**BLACK**



ULTRA LIGHTWEIGHT

LARGE CIRCULAR FIELD OF VIEW

GLOW-IN-THE-DARK SHOOTER'S RING



# BRITE•SITE™ XTREME

BASED ON THE AWARD-WINNING TRU•SITE™ XTREME SERIES

- Lightweight, composite pin guard
- BRITE•DOT™ wrapped pin design
- Markings for elevation and windage
- Adjustable for left and right-handed shooters

5-Pin - Black  
**TG550XB**

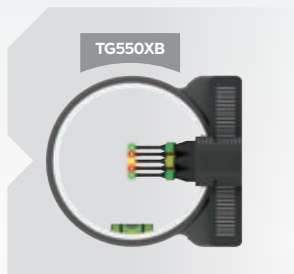

### Push-Button LED Included

TRU•LITE™ (TG55) removable violet rheostat LED sight light.  
See page 49 for details.



## MODEL SPECS

MODEL	PINS	FINISH	CONSTRUCTION	LIGHT	LEVEL	APERTURE DIAMETER	WINDAGE / ELEVATION
<b>TG550XB</b>	5 (5x.029" dia.)	Black	CNC-machined aluminum / composite	Removable LED - violet	High-visibility	2 in.	Standard adjustment

**BLACK**



ULTRA LIGHTWEIGHT

LARGE CIRCULAR FIELD OF VIEW

GLOW-IN-THE-DARK SHOOTER'S RING

TRUGLO® ARCHERY / CROSSBOW 2017



NEW ARCHER'S CHOICE®

# RANGE•ROVER™ PRO

THE INDUSTRY'S BEST LED BOW SIGHT



### Adjustment Dial

provides remarkably precise Micro-adjustable elevation tuning giving hunters an extra edge.

TG6401GB



### TRUGLO® NEOPRENE LENS COVER INCLUDED



Micro LED Illuminated Center•Dot technology appears finer as you decrease brightness for pinpoint accuracy.

NEW

1-Pin - Black  
TG6401GB



## PRODUCT FEATURES

- ZERO-IN™ Adjustment Dial with over 80 included pre-marked yardage tapes for simple setup
- Scope housing has 1/2 in. diameter circle with lighted center dot for superior long distance accuracy
- Adjustable green LED with 11 brightness settings with included CR2032 battery
- Micro-adjustable windage – precision click design
- Tool-less yardage and windage lock
- Sight housing accepts 1.87 in. scope lens (sold separately)
- Adjustable end-of-travel stop customizes maximum yardage setting
- Laser marks for windage and elevation adjustments
- Adjustable for left and right-handed shooters
- Adjustable quiver mount included
- Lens cover included
- Patent pending

### NEW TACTILE BRIGHTNESS CONTROL

Push-button brightness control for easy adjustment. Idle auto-off feature conserves battery life.



AVAILABLE ACCESSORIES	DESCRIPTION
TG70A - Range-Rover Lens Kit	2x Magnification, +/- .5 diopter adjustment, includes locking ring
TG6401RT - Replacement yardage tape set	80+ multi-colored yardage tapes

## MODEL SPECS

MODEL	PINS	FINISH	CONSTRUCTION	LEVEL	APERTURE DIAMETER	WINDAGE / ELEVATION
NEW TG6401GB	1 (Adjustable green LED with 11 brightness settings)	Black	CNC-machined aluminum	Adjustable 2nd and 3rd axis illuminated	1.8 in.	ZERO-IN™ elevation adjustment dial, Ultra-fine click tool-less micro-adjustable windage

BLACK

ILLUMINATED  
PWR•DOT

MICRO  
ADJUST

TOOL-LESS  
DESIGN

LARGE CIRCULAR  
FIELD OF VIEW

GLOW-IN-THE-DARK  
SHOOTER'S RING



# ARCHER'S CHOICE® RANGE•ROVER™ SERIES

SINGLE-PIN BOW SIGHTS

14

BOW SIGHTS



## Adjustment Dial

provides remarkably precise  
Micro-adjustable elevation  
tuning giving hunters an  
extra edge.

The TRUGLO® RANGE•ROVER™ Series has long been synonymous with premium single-pin bow sights. Now, there's even more reason to join Ralph and Vicki in their enthusiasm for these beautifully simple and effective hunting tools. Innovative ZERO-IN™ Adjustment Dial provides ultra-smooth, remarkably precise micro-adjustable elevation tuning, giving hunters an extra edge in difficult conditions.

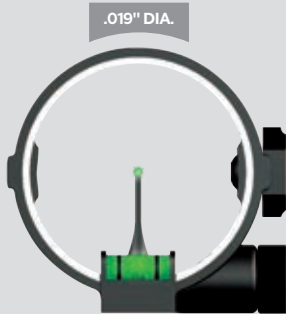

.019" DIA.



.010" DIA.

## PRODUCT FEATURES

- ZERO-IN™ Adjustment Dial with over 80 included pre-marked yardage tapes for simple setup
- Tool-less yardage lock
- Clean, circular sight picture with all-metal pin
- Extra-long, fully-protected wrapped fiber
- Ultra-smooth bracket movement for easy one-hand adjustment
- Sight housing accepts 1.87 in. scope lens (sold separately)
- Adjustable end-of-travel stop customizes maximum yardage setting
- Laser marks for windage and elevation adjustments
- Quiver can be mounted directly to bracket
- Available in dedicated left-handed and right-handed configurations
- Adjustable quiver mount included (except TG6211B)
- Patent pending

TRUGLO® ARCHERY / CROSSBOW 2017



### Adjustable Brightness LED

TRU•LITE™ XTREME (TG56) removable violet rheostat LED sight light.

See page 49 for details.



1-Pin - Black  
**TG6211B**



1-Pin - XTRA™  
**TG6311J**



#### AVAILABLE ACCESSORIES

**TG70A** - Range•Rover Lens Kit

**TG6401RT** - Replacement yardage tape set

**TG399G** - Optional Quiver Mount

#### DESCRIPTION

2x Magnification, +/- .5 diopter adjustment, includes locking ring

80+ multi-colored yardage tapes

For TG6211B

## MODEL SPECS

MODEL	ORIENTATION	PINS	FINISH	CONSTRUCTION	LIGHT	LEVEL	APERTURE DIAMETER	WINDAGE / ELEVATION	TRU•TOUCH™
<b>TG6211B</b>	Right-handed	1 (.019" dia.)	Black	CNC-machined aluminum	Sold separately	Adjustable 2nd and 3rd axis	1.8 in.	Standard adjustment	No
<b>TG6311B</b>			Realtree™ XTRA™					Ultra-fine click windage adjustment Lever arm elevation adjustment	
<b>TG6311BLH</b>	Left-handed	1 (.010" dia.)	Black		Removable adjustable rheostat LED - violet			ZERO-IN™ elevation adjustment dial Ultra-fine click tool-less micro-adjustable windage	Yes
<b>TG6321B</b>	Right-handed								
<b>TG6411B</b>	Left-handed	1 (.019" dia.)	Black		Removable adjustable rheostat LED - violet			ZERO-IN™ elevation adjustment dial Ultra-fine click tool-less micro-adjustable windage	Yes
<b>TG6411BLH</b>									

XTRA™

BLACK

MICRO  
ADJUST

TOOL-LESS  
DESIGN

LARGE CIRCULAR  
FIELD OF VIEW

DEDICATED  
LEFT-HANDED MODEL

GLOW-IN-THE-DARK  
SHOOTER'S RING

LIGHT  
INCLUDED



# PENDULUM SERIES

THE ULTIMATE TREESTAND BOW SIGHTS

16

BOW SIGHTS



TG700

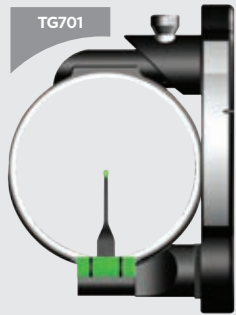

TG701

*Experienced hunters are familiar with the incredible advantage of shooting from an elevated position. For years, PENDULUM Series sights have been the top choice of treestand hunters, due to their unique Pendulum Adjustment System, which automatically compensates for distances of up to 35 yards. Extremely quiet and constructed with lightweight, durable CNC-machined aluminum, these tool-less sights can also be locked in place for ground shooting.*



1-Pin - Black  
**TG700**

1-Pin - Black  
**TG701**

### Removable LED Light

TRU•LITE™ (TG55) included with model TG700. See page 49 for details.



### Adjustable Brightness LED

(Included on model TG701) TRU•LITE™ XTREME (TG56) removable violet rheostat LED sight light. See page 49 for details.



## PRODUCT FEATURES

- Extremely quiet
- The most advanced treestand sights available
- Automatically compensates for distances of up to 35 yards
- Pendulum can be locked in place for ground shooting
- Extra-long protected, wrapped fiber
- Adjustable for left and right-handed shooters
- Pre-printed yardage tapes included (TG701 only)
- Patent Pending

## MODEL SPECS

MODEL	PINS	FINISH	BRACKET	CONSTRUCTION	LIGHT	LEVEL	APERTURE DIAMETER	WINDAGE / ELEVATION
TG700	1(.029" dia.)	Black	Fixed	CNC-machined aluminum	Removable LED - violet	High-visibility	1.8 in.	Lever arm elevation adjustment Standard windage adjustment
TG701	1(.019" dia.)		Adjustable		Removable adjustable rheostat LED - violet			

**BLACK**



ULTRA LIGHTWEIGHT

LARGE CIRCULAR FIELD OF VIEW

GLOW-IN-THE-DARK SHOOTER'S RING

LIGHT INCLUDED





# ARROW RESTS

Advanced methods of holding your arrow for each shot.



NEW

# LOCK•FIRE™

ULTRA-FAST, CLICK-UP, DROP-AWAY ARROW REST

18

ARROW RESTS

## Colored Inserts

Choose between 5 included color-matching SILENT•DRAW inserts for a custom look and quiet arrow loading. Red shown on product.



## Speed-Activated Hammer

When firing, launcher remains up for maximum arrow support, then rapidly drops to avoid vane contact. Arrow remains captured even during let down.

*Load, Lock, Fire! Brand new for this year, LOCK•FIRE™ has it all. Lock the launcher in the upward position using the ergonomic thumb lever, or simply draw the bow to raise the launcher automatically. When fired, delayed-drop actuation allows the launcher to support the arrow longer for increased accuracy. The speed-activated hammer rapidly drops the launcher as the vanes approach. Fitting all bows and arriving in dedicated left-handed and right-handed models, LOCK•FIRE brings innovation and accuracy to any high-performance bow.*



NEW

Black  
TG650B

## PRODUCT FEATURES

- Full-capture rest holds arrow in place
- Independent windage and elevation adjustments
- Arrow is supported on SILENT•DRAW polymer insert (5 replaceable colored inserts included)
- Easy setup and tuning for all bow types
- Ergonomic thumb lever can also be used to lock the launcher up
- Raises when you draw, then locks up when you let down
- Operated by downward-moving buss cable – cable clamp included
- No launcher movement or vertical arrow movement during draw when launcher is locked up
- Delayed drop actuation – supports arrow longer for increased accuracy and consistency, then drops rapidly as vanes approach
- Cushioned adjustable down-stop absorbs launch momentum
- Available in dedicated left-handed and right-handed models
- Patent pending



MODEL SPECS

MODEL	FINISH	ORIENTATION	TYPE	CONSTRUCTION	LAUNCHER ARM	VANE CLEARANCE	WINDAGE / ELEVATION	REFERENCE MARKS	COMPATIBILITY
<b>NEW</b> TG650B	Black	Right-handed	<ul style="list-style-type: none"> <li>• Hammer-fired</li> <li>• Click-up</li> <li>• Drop-away</li> <li>• Full-containment</li> </ul>	Lightweight carbon composite and aluminum construction	<ul style="list-style-type: none"> <li>• Ultra-fast movement</li> <li>• Stainless steel</li> </ul>	Maximum	Full adjustments	Laser engraved	<ul style="list-style-type: none"> <li>• Carbon and aluminum arrows</li> <li>• All shaft diameters</li> </ul>
<b>NEW</b> TG650BLH		Left-handed							

BLACK

ULTRA FAST DROP-AWAY

ULTRA QUIET

DELAYED-DROP ACTUATION

DEDICATED LEFT-HANDED MODEL

COLOR-MATCHING INSERTS



# UP•DRAFT™

LIMB-DRIVEN, FULL-CONTAINMENT, DROP-AWAY ARROW REST

20

ARROW RESTS

## Colored Inserts

Choose between 5 included color-matching inserts for a custom look and quiet arrow loading. Red shown on product.



## Left-Handed Conversion

Simple / Quick conversion for left-handed shooters



## PRODUCT FEATURES

- Limb-driven for longer support and fine tuning
- Full-containment drop-away arrow rest
- High-strength torsion spring increases launcher arm performance
- Sealed bushings increase downward speed at launch
- Quick and easy installation – no bow press required
- Attaches to either top or bottom limb
- No unwanted bounce-back when firing
- Technical rubber dampeners for silent arrow loading – no more felt!
- Universal design for left and right-handed shooters
- Patented

## MODEL SPECS

MODEL	FINISH	TYPE	CONSTRUCTION	LAUNCHER ARM	VANE CLEARANCE	WINDAGE / ELEVATION	REFERENCE MARKS	COMPATIBILITY
TRG640B	Black	<ul style="list-style-type: none"> <li>• Limb-driven</li> <li>• Drop-away</li> <li>• Full-containment</li> </ul>	Lightweight, all-metal	<ul style="list-style-type: none"> <li>• High-speed movement</li> <li>• Stainless steel</li> </ul>	Maximum	Full adjustments	Laser engraved	<ul style="list-style-type: none"> <li>• Carbon and aluminum arrows</li> <li>• All shaft diameters</li> </ul>
TRG640J	Realtree™ XTRA™							

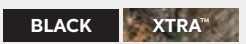

ULTRA LIGHTWEIGHT

HIGH-SPEED DROP-AWAY

ULTRA QUIET

ALL-METAL CONSTRUCTION

LEFT-HANDED CONVERSION

COLOR-MATCHING INSERTS



# DOWN·DRAFT™

CABLE-DRIVEN, FULL-CONTAINMENT, DROP-AWAY ARROW REST

### Colored Inserts

Choose between 5 included color-matching inserts for a custom look and quiet arrow loading. Red shown on product.



### Left-Handed Conversion

Simple / Quick conversion for left-handed shooters



Black  
**TG630B**

## PRODUCT FEATURES

- Full-containment drop-away arrow rest
- High-performance drop-away design
- Sealed bushings increase downward speed at launch
- Quick and easy installation – no bow press required
- Attaches to downward-moving buss cable
- No unwanted bounce-back when firing
- Technical rubber dampeners for silent arrow loading – no more felt!
- Universal design for left and right-handed shooters
- Patented

## MODEL SPECS

MODEL	FINISH	TYPE	CONSTRUCTION	LAUNCHER ARM	VANE CLEARANCE	WINDAGE / ELEVATION	REFERENCE MARKS	COMPATIBILITY
TG630B	Black	<ul style="list-style-type: none"> <li>• Cable-driven</li> <li>• Drop-away</li> <li>• Full-containment</li> </ul>	Lightweight, all-metal	<ul style="list-style-type: none"> <li>• High-speed movement</li> <li>• Stainless steel</li> </ul>	Maximum	Full adjustments	Laser engraved	<ul style="list-style-type: none"> <li>• Carbon and aluminum arrows</li> <li>• All shaft diameters</li> </ul>
TG630J	Realtree™ XTRA™							

BLACK XTRA™

ULTRA LIGHTWEIGHT

HIGH-SPEED DROP-AWAY

ULTRA QUIET

ALL-METAL CONSTRUCTION

LEFT-HANDED CONVERSION

COLOR-MATCHING INSERTS



# CARBON XS™

CABLE-DRIVEN, DROP-AWAY ARROW REST

22

ARROW RESTS

## Left-Handed Conversion

Simple / Quick conversion for left-handed shooters



Black  
TG625B



## PRODUCT FEATURES

- Full-containment drop-away arrow rest
- High-strength torsion spring increases launcher arm performance
- Sealed bushings increase downward speed at launch
- Quick and easy installation – no bow press required
- Attaches to downward-moving buss cable
- No unwanted bounce-back when firing
- Universal design for left and right-handed shooters
- Patented

## MODEL SPECS

MODEL	FINISH	TYPE	CONSTRUCTION	LAUNCHER ARM	VANE CLEARANCE	WINDAGE / ELEVATION	REFERENCE MARKS	COMPATIBILITY
TG625B	Black	<ul style="list-style-type: none"> <li>• Cable-driven</li> <li>• Drop-away</li> </ul>	Ultra-lightweight carbon composite	<ul style="list-style-type: none"> <li>• High-speed movement</li> <li>• Stainless steel</li> </ul>	Maximum	Full adjustments	Laser engraved	<ul style="list-style-type: none"> <li>• Carbon and aluminum arrows</li> <li>• All shaft diameters</li> </ul>

BLACK

ULTRA LIGHTWEIGHT

HIGH-SPEED DROP-AWAY

ULTRA QUIET

CARBON-COMPOSITE CONSTRUCTION

LEFT-HANDED CONVERSION



# STORM™

ULTRA-LIGHTWEIGHT, CAPTURE-STYLE REST

### Colored Inserts

Choose between 5 included color-matching dual-coil inserts for a custom look and quiet arrow loading. Red shown on product.



### Left-Handed Conversion

Simple / Quick conversion for left-handed shooters



For archers preferring a capture-style rest, STORM™ combines waterproof nylon brushes with a technical rubber launcher – avoiding the wear and tear of felt and providing a full-containment system with minimal friction.



## PRODUCT FEATURES

- Capture-style arrow rest
- Adjustable brushes hold arrow at almost any angle
- Dual-coil launcher is adjustable / replaceable
- Reduced arrow contact increases speed and accuracy
- Fast and quiet arrow release
- Easy tuning adjustments
- Technical rubber insert for silent arrow loading – no more felt!
- Ultra-tough all-weather design
- Great for traditional target shooting, 3-D and hunting
- Quick and easy installation
- Universal design for left and right-handed shooters

## MODEL SPECS

MODEL	FINISH	TYPE	CONSTRUCTION	LAUNCHER ARM	VANE CLEARANCE	WINDAGE / ELEVATION	REFERENCE MARKS	COMPATIBILITY
TG620B	Black	Capture-style	Lightweight composite and aluminum construction	Dual-coil	Optimal	Full adjustments	Laser engraved	<ul style="list-style-type: none"> <li>• Carbon and aluminum arrows</li> <li>• All shaft diameters</li> </ul>

**BLACK**

ULTRA LIGHTWEIGHT

FULL CONTAINMENT

ULTRA QUIET

CARBON-COMPOSITE CONSTRUCTION

LEFT-HANDED CONVERSION

COLOR-MATCHING INSERTS



# RELEASES

The critical link between the hunter and the bow.





NEW

# ACTIVATOR™

SINGLE-JAW ROLLER SEAR PRECISION RELEASE



### Jaw-And-A-Half Design

Single stainless steel moving jaw with fixed flat opposing jaw. Smooth release like a single-jaw, locks-on like a dual-jaw.



### Leather Strap Available

TG2570MLB features a leather wrist strap and steel single-buckle closure.



### BOA® Closure System

For glove-like fit and all-day comfort. Included with TG2570MBC.



### Side•Lock Connector

Connector locks release-head out of the way.



New for 2017, we've combined all of the advantages of a dual-jaw release with the simplicity and accuracy of our popular DETONATOR™ single-jaw design. The active jaw opens quickly and smoothly while the opposing side remains constant. An active spring reset quickly sets the action for your next shot. ACTIVATOR™ comes standard with a roller sear adjustable trigger and is available with the BOA® wrist strap or a leather strap and steel buckle.



NEW

BOA® - APG™  
TG2570MBC

## PRODUCT FEATURES

- Quiet, fast and accurate
- Automatic / active spring trigger reset
- Jaw opens away from the shooter for more comfort
- Roller sear design for a smooth trigger pull with a crisp break
- Adjustable trigger sensitivity
- Micro-adjustable trigger travel
- Uncompromising rock-solid connection system for ultra-precise length adjustments
- Precision stainless steel wear-free jaw
- Ergonomic hand and finger position
- 360° rotating head eliminates string torque
- Premium release strap for long-lasting comfort
- Patented

## MODEL SPECS

MODEL	CLOSURE TYPE	CONNECTION SYSTEM	STRAP FINISH	TRIGGER DESIGN	JAW DESIGN	CONSTRUCTION
NEW TG2570MLB	Steel Buckle	Side•Lock	Black Leather	Crisp roller sear with adjustable sensitivity / travel	Stainless steel moving jaw with opposing non-moving jaw	Stainless steel jaw and firing mechanism
NEW TG2570MBC	BOA® Closure System		Realtree™ APG™			

BLACK LEATHER

APG™

ULTRA QUIET

MICRO ADJUST

SIDE•LOCK CONNECTOR

BOA® CLOSURE SYSTEM

STAINLESS STEEL JAW & FIRING MECHANISM



**NEW**

# NITRUS™

ULTRA-SMOOTH, DUAL-JAW ARCHERY RELEASE



26

RELEASES

### Dual-Jaw Design

Breakthrough stainless steel caliper jaw design with forward trigger position.



### Leather Strap Available

TG2550MLB features a leather wrist strap and steel single-buckle closure.



### BOA® Closure System

For glove-like fit and all-day comfort. Included with most NITRUS™ models.



### Side•Lock Connector

Connector locks release-head out of the way.



BOA® - Black  
**TG2550SBB**



BOA® - APG™  
**TG2550MBC**

## PRODUCT FEATURES

- Extremely quiet
- Breakthrough stainless steel dual-jaw design provides a perfectly balanced release
- Ultra-smooth, micro-adjustable trigger pull with a crisp feel
- No unwanted trigger travel
- Streamlined jaw design for fast and easy loading – perfect for string loops
- Stainless steel firing mechanism for increased durability and repeatability
- Forward trigger position enables faster arrow speeds
- Ergonomic hand and finger position
- 360-degree rotating head eliminates string torque
- Premium release strap for long-lasting comfort
- Precision stainless steel wear-free jaws
- Patented

## MODEL SPECS

MODEL	CLOSURE TYPE	CONNECTION SYSTEM	STRAP FINISH	TRIGGER DESIGN	JAW DESIGN	CONSTRUCTION
<b>NEW</b> TG2550MLB	Steel Buckle	Side•Lock	Black Leather	Ultra-smooth and crisp with micro-adjustable sensitivity / travel	Breakthrough stainless steel dual-jaw design	Jaws: stainless steel Firing mechanism: stainless steel
TG2550SBC	BOA® Closure System	Durable Nylon	Realtree™ APG™			
TG2550SBB			Black			
TG2550MBB		Side•Lock	Realtree™ APG™			
TG2550MBC						

BLACK LEATHER

BLACK

APG™

ULTRA QUIET

MICRO ADJUST

SIDE•LOCK CONNECTOR

BOA® CLOSURE SYSTEM

STAINLESS STEEL JAW & FIRING MECHANISM

TRUGLO® ARCHERY / CROSSBOW 2017



**NEW**

# DETONATOR™

ULTRA-SMOOTH, SINGLE-JAW ARCHERY RELEASE



### Single-Jaw Design

Stainless steel single-jaw design with magnetic hook for fast, easy loading and crisp, consistent release.



### Leather Strap Available

TG2560MLB features a leather wrist strap and steel single-buckle closure.



### BOA® Closure System

For glove-like fit and all-day comfort. Included with most DETONATOR™ models.



### Side•Lock Connector

Connector locks release-head out of the way.



BOA® - Black  
**TG2560SBB**

**NEW**  
Black Leather  
**TG2560MLB**

## PRODUCT FEATURES

- Quiet, fast and accurate
- Streamlined open-hook single-jaw design for fast and easy loading – perfect for string loops
- Hook opens away from shooter for more comfort
- Ultra-smooth, micro-adjustable trigger pull with a crisp feel
- Precision stainless steel wear-free jaw
- Stainless steel firing mechanism for increased durability and repeatability
- Forward trigger position enables faster arrow speeds
- Ergonomic hand and finger position
- 360-degree rotating head eliminates string torque
- Premium release strap for long-lasting comfort
- Patented

## MODEL SPECS

MODEL	CLOSURE TYPE	CONNECTION SYSTEM	STRAP FINISH	TRIGGER DESIGN	JAW DESIGN	CONSTRUCTION
<b>NEW</b> TG2560MLB	Steel Buckle	Side•Lock	Black Leather	Ultra-smooth and crisp with micro-adjustable sensitivity / travel	Breakthrough stainless steel single-jaw design	Jaws: stainless steel Firing mechanism: stainless steel
TG2560SBC	BOA® Closure System	Durable Nylon	Realtree™ APG™			
TG2560SBB		Black				
TG2560MBB		Side•Lock	Realtree™ APG™			
TG2560MBC						



ULTRA  
QUIET

MICRO  
ADJUST

SIDE•LOCK  
CONNECTOR

BOA®  
CLOSURE SYSTEM

STAINLESS STEEL JAW  
& FIRING MECHANISM



# TRU•FIT™ UNIVERSAL



REPLACEMENT RELEASE STRAP

28

RELEASES

## BOA® Closure System

The patented BOA® Closure System makes finding the perfect fit easy. DIAL-IN all-day custom comfort with a simple twist.



APG™  
TG2590BC

## Universal Connection System

The universal connection system fits most popular styles.



Universal



Nylon strap



Scott™



T.R.U. Ball™



Cobra®



Rope



Scott™



Tru-Fire®



Black  
TG2590BB

## PRODUCT FEATURES

- Replaces your broken / worn-out wrist strap
- Fits almost any connection system
- Adjustable BOA® Closure System for a glove-like fit and all-day custom comfort
- Quick on / quick off, one-hand adjustment
- Easy-to-clean BOA® closure sheds mud, dirt and even ice
- Patented

## MODEL SPECS

MODEL	CLOSURE TYPE	CONNECTION SYSTEM	STRAP FINISH	CONSTRUCTION
TG2590BB	BOA® Closure System	Universal - fits most popular styles (see above) Includes optional nylon rope connector	Black	Machined aluminum universal joint
TG2590BC			Realtree™ APG™	

BLACK

APG™

ULTRA  
QUIET

MICRO  
ADJUST

SIDE•LOCK  
CONNECTOR



# SPEED SHOT™ XS

DUAL-JAW ARCHERY RELEASES



## BOA® Closure System

For glove-like fit and all-day comfort.



## Colored Covers

Choose from 5 color-matching covers to customize your release.



## Dedicated Junior Model

Designed to comfortably and safely fit smaller shooters. (Models TG2511BC & TG2511VB)



Junior - Black  
TG2511VB



BOA® Standard - APG™  
TG2510BC

## PRODUCT FEATURES

- Comfort-fit strap design
- Torque-free 360-degree rotating head
- Synchronized, compact dual-jaw design for smooth trigger pull
- Compact dual-jaw design, perfect for string loops
- Precision wear-free jaws
- Over 1 inch of total length adjustment
- Junior model features scaled-down wrist strap for smaller shooters
- Patented

## MODEL SPECS

MODEL	SIZE	CLOSURE TYPE	CONNECTION SYSTEM	STRAP FINISH	TRIGGER DESIGN	JAW DESIGN	CONSTRUCTION
TG2510BC	Standard	BOA® Closure System	Silent rotary adjustable length connector	Realtree™ APG™	Contoured, adjustable one-piece trigger	Synchronized, compact dual-jaw design	All-metal
TG2511BC	Junior			Black			
TG2510VB	Standard	Standard hook-and-loop					
TG2511VB	Junior						

BLACK

APG™

ULTRA QUIET

MICRO ADJUST

BOA® CLOSURE SYSTEM

COLOR MATCHING



# QUIVERS

Carry your arrows safely and effectively.



**NEW**

# TRU•TEC™ LT

LIGHTWEIGHT, DURABLE ALUMINUM QUIVER

### Hanging Loop

For treestands or ground blinds.



### Colored Inserts

Choose from 5 color-matching inserts to customize your quiver.



### POSITIVE•LOCK Mounting System

For smooth one-hand removal and ultra-secure attachment.



### Optional LED Light

Install TRU•LITE™ (TG55) or TRU•LITE™ XTREME (TG56) removable light for ultimate lowlight visibility. (Sold separately) See page 49 for details.



## PRODUCT FEATURES

- Ultra-lightweight aluminum construction
- Weighs less than 10 oz.
- Interchangeable colored vibration dampening inserts
- POSITIVE•LOCK mounting bracket
- Smooth, one-hand removal
- Hanging loop for treestands or ground blinds
- Mounting bracket adjusts up / down to better fit all bows
- Rubber hood insert reduces noise and won't dull broadheads
- Fits both carbon and aluminum arrows
- Fits both mechanical and fixed broadheads
- Fits both left and right-handed bows
- TRU•TOUCH™ Soft-Feel Technical Coating
- Patented

**AVAILABLE ACCESSORY**  
**TG399E** - TRU•TEC™ Quiver Mount



**NEW**

LOST® XD  
**TG315M2**

**5**  
 ARROW  
 QUIVER

EASTON  
 MICRO SHAFT  
**GXH**  
 COMPATIBLE



## MODEL SPECS

MODEL	FINISH	ARROWS	MOUNTING SYSTEM	GRIPPER DESIGN	ARROW COMPATIBILITY	CONSTRUCTION	TRU•TOUCH™
TG315B2	Black	Up to 5	POSITIVE•LOCK Smooth one-hand removal and ultra-secure attachment	Rubberized, secure double-grippers	Fits both carbon and aluminum arrows with shafts .229" diameter and larger Fits both mechanical and fixed broadheads	CNC-machined lightweight, durable aluminum	Yes
<b>NEW</b> TG315M2	LOST® XD						
TG315J2	Realtree™ XTRA™						

**BLACK** **XTRA™** **LOST® XD**

ULTRA  
 LIGHTWEIGHT

ULTRA  
 QUIET

ALUMINUM  
 CONSTRUCTION

VIBRATION  
 FREE

COLOR  
 MATCHING



# CARBON XS™

LIGHTWEIGHT, CARBON COMPOSITE QUIVER

32

QUIVERS

## Hanging Loop

For treestands or ground blinds.



## POSITIVE•CAM•LOCK Mounting System

For smooth one-hand removal – holds quiver tight against bow riser for superior balance.



## PRODUCT FEATURES

- Durable carbon-composite spine
- Weighs less than 12 oz.
- POSITIVE•CAM•LOCK mounting system
- Secure double-gripper design
- Hanging loop for treestands or ground blinds
- Mounting bracket adjusts to fit all bows
- Rubber hood insert reduces noise and won't dull broadheads
- Fits both left and right-handed bows
- TRU•TOUCH™ Soft-Feel Technical Coating
- Patented

**AVAILABLE ACCESSORY**  
TG399L - CARBON XS™ Quiver Mount

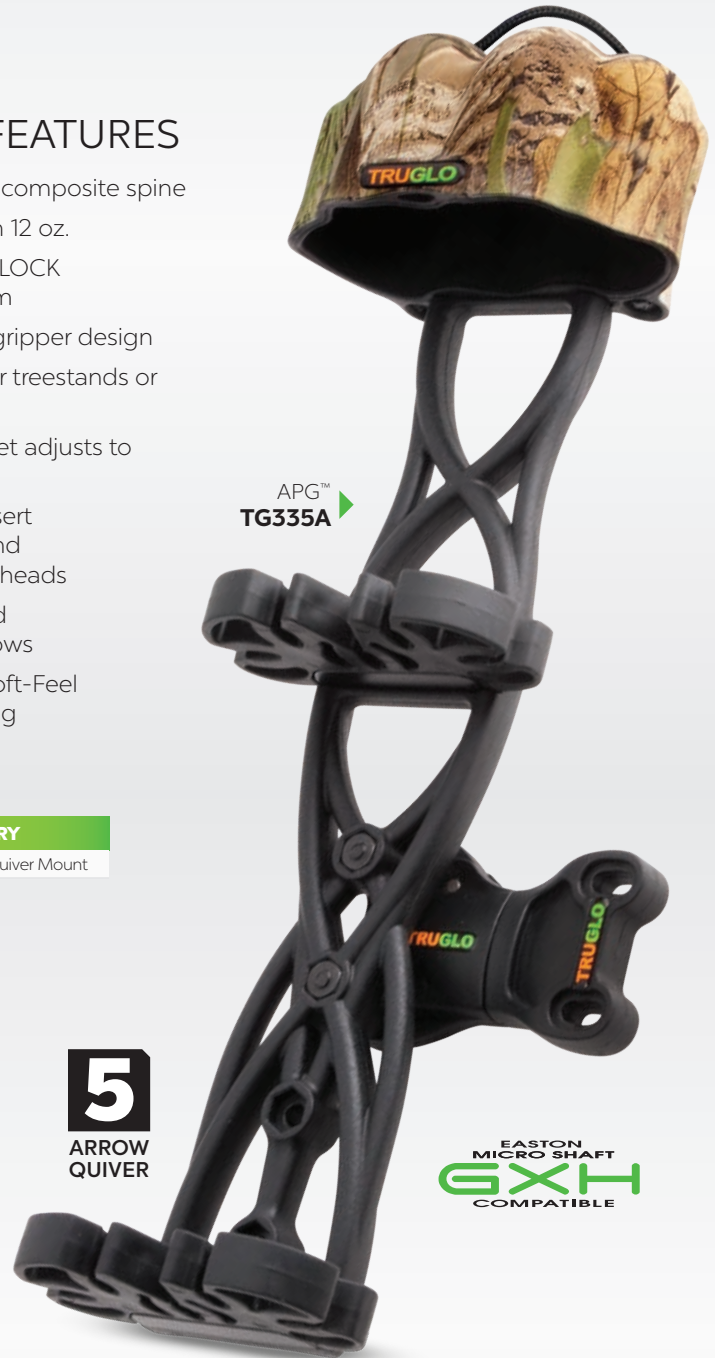

**5**  
ARROW  
QUIVER

EASTON  
MICRO SHAFT  
**GXH**  
COMPATIBLE



## MODEL SPECS

MODEL	FINISH	ARROWS	MOUNTING SYSTEM	GRIPPER DESIGN	ARROW COMPATIBILITY	CONSTRUCTION	TRU•TOUCH™
TG335A	Realtree™ APG™	Up to 5	POSITIVE•CAM•LOCK Smooth one-hand removal – moves quiver tight against bow riser for superior balance (patented)	Rubberized, secure double-grippers	Fits both carbon and aluminum arrows with shafts .229" diameter and larger Fits both mechanical and fixed broadheads	Ultra-lightweight, durable carbon composite	Yes
TG335B	Black						
TG335F	Lost AT®						
TG335J	Realtree™ XTRA™						

BLACK | APG™ | XTRA™ | LOST AT®

ULTRA  
LIGHTWEIGHT

ULTRA  
QUIET

CARBON-COMPOSITE  
CONSTRUCTION

VIBRATION  
FREE





# LOC•DOWN™

LIGHTWEIGHT, COMPOSITE QUIVER

## TWIST•LOCK Mounting System

For easy, smooth and quiet one-hand removal – locks securely for added stability.



## Quiver Mount

(TG399D) Additional / replacement quiver mounts available separately.



## PRODUCT FEATURES

- TWIST•LOCK mounting system
- Weighs less than 8 oz.
- Secure double-gripper design
- Mounting bracket adjusts up / down to better fit all bows
- Rubber hood insert reduces noise and won't dull broadheads
- Fits both left and right-handed bows
- TRU•TOUCH™ Soft-Feel Technical Coating
- Patented

### AVAILABLE ACCESSORY

**TG399D** - LOC•DOWN™ Quiver Mount

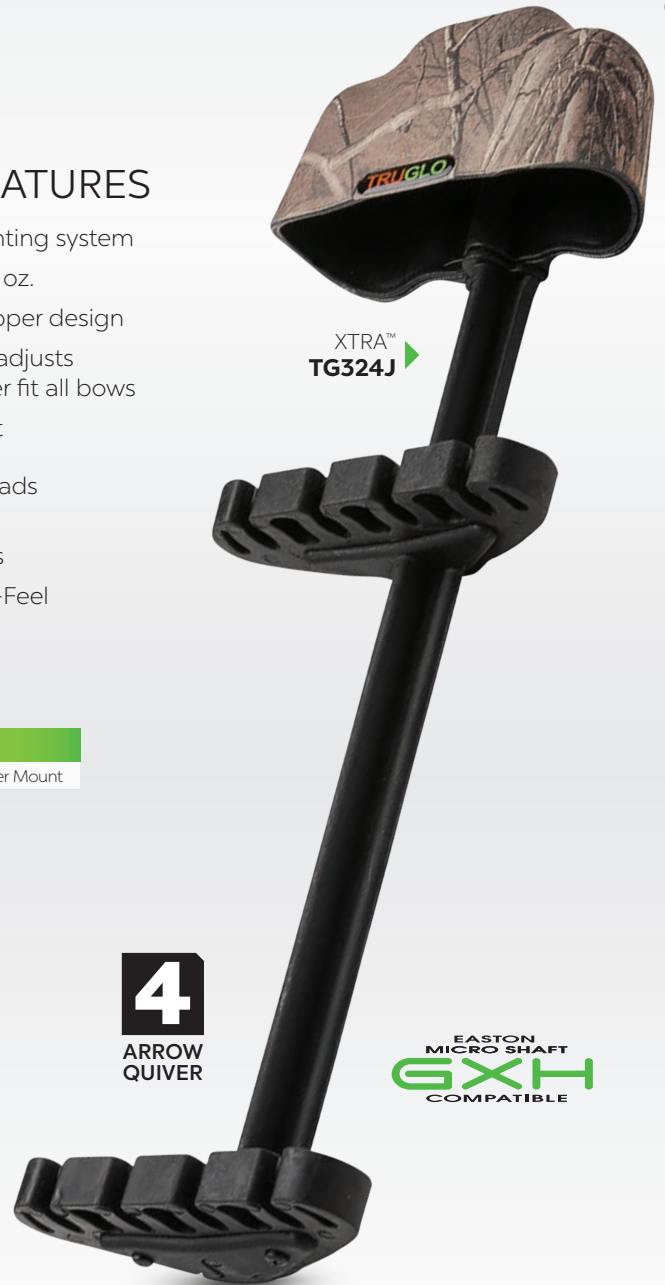

XTRA™  
TG324J

**4**  
ARROW  
QUIVER

EASTON  
MICRO SHAFT  
**GXH**  
COMPATIBLE



## MODEL SPECS

MODEL	FINISH	ARROWS	MOUNTING SYSTEM	GRIPPER DESIGN	ARROW COMPATIBILITY	CONSTRUCTION	TRU•TOUCH™
TG324A	Realtree™ APG™	Up to 4	TWIST•LOCK Smooth one-hand removal – moves quiver tight against bow riser for superior balance (patented)	Rubberized, secure double-grippers	Fits both carbon and aluminum arrows, with shafts .229" diameter and larger Fits both mechanical and fixed broadheads	Lightweight composite	Yes
TG324X	Black						
TG324F	Lost AT®						
TG324J	Realtree™ XTRA™						
TG324P	Realtree™ APC™ PINK						



ULTRA  
LIGHTWEIGHT

ULTRA  
QUIET

VIBRATION  
FREE



# TUFF•LOC™

LIGHTWEIGHT, COMPACT COMPOSITE QUIVER

34

QUIVERS

### Quick-Release CAM•LOCK

For easy, smooth and quiet one-hand removal – locks securely for added stability.



### Contrasting Color Rubber Hood Liner

Reduces noise and won't dull broadheads. Contrasting color helps reflect light for visibility.



Black  
TG344B

## PRODUCT FEATURES

- Lightweight / compact design
- Weighs less than 7 oz.
- Quick-release CAM•LOCK mounting system
- Thumb-tab style gripper design allows quick and quiet arrow removal
- Contrasting color rubber hood liner reduces noise and won't dull broadheads
- Fits both left and right-handed bows
- Compatible with most crossbows
- Patent pending

### AVAILABLE ACCESSORY

TG399J - TUFF•LOC™ Quiver Mount

**4**

ARROW  
QUIVER

EASTON  
MICRO SHAFT  
**GXH**  
COMPATIBLE

## MODEL SPECS

MODEL	FINISH	ARROWS	MOUNTING SYSTEM	GRIPPER DESIGN	ARROW COMPATIBILITY	CONSTRUCTION
TG344B	Black	Up to 4	Quick-release CAM•LOCK for easy, smooth one-hand removal	Rubberized, secure single-gripper	Fits both carbon and aluminum arrows with shafts .229" diameter and larger Fits both mechanical and fixed broadheads	Lightweight, compact durable composite

BLACK

ULTRA  
LIGHTWEIGHT

ULTRA  
QUIET

VIBRATION  
FREE



# STABILIZERS

Balance your bow while reducing vibration and noise.



# TRU•TEC™ CARBON PRO

ADJUSTABLE-WEIGHT, CARBON-COMPOSITE STABILIZER

36

STABILIZERS

## High-Modulus Carbon Fiber

Provides superior strength and stability under virtually any conditions.



6 in. - XTRA™  
TG855J



## Adjustable Weight

1 oz. weights can be added or removed to achieve ideal bow balance.



## PRODUCT FEATURES

- High-modulus carbon fiber rod for superior strength
- Carbon-composite exoskeleton
- Tri-Foil shape for optimal rigidity
- Vibration dampening adjustable weight suspension system (includes 3 stainless steel 1 oz. weights)
- Performance-based composites for vibration / noise reduction
- Engineered for performance bows
- TRU•TOUCH™ Soft-Feel Technical Coating

## MODEL SPECS

MODEL	FINISH	LENGTH	WEIGHT	MOUNTING SYSTEM	DAMPENER DESIGN	CONSTRUCTION	COMPATIBILITY	TRU•TOUCH™
TG855B	Black	6 in.	Adjustable from 4 to 7 oz.	Standard threaded mount	Vibration-dampening adjustable weight suspension system	Carbon composite exoskeleton with high-modulus carbon fiber reinforcement rod	Fits all bows	Yes
TG855J	Realtree™ XTRA™							

BLACK XTRA™

ADJUSTABLE WEIGHT

CARBON-COMPOSITE CONSTRUCTION

VIBRATION / NOISE ABSORBING TECHNOLOGY

TRUGLO® ARCHERY / CROSSBOW 2017



**NEW**

# CARBON XS™

VIBRATION-DAMPENING, ADJUSTABLE-WEIGHT STABILIZER WITH SLING

### Sling Included

- Tough anodized metal mounting bracket
- Stiff, adjustable fit paracord sling
- Black sling included with TG840B and TG845B, camo sling included on camo models.)



### Colored Dampening Rings

Choose from 6 color-matching dampening rings to customize your stabilizer.



### Adjustable Weight

1 oz. weights can be added or removed to achieve ideal bow balance.



9 in. - Black  
**TG840B**



**NEW**  
7 in. - LOST® XD  
**TG845M**

## PRODUCT FEATURES

- Performance-based composites for vibration / noise reduction
- Interchangeable colored dampening rings
- Includes stiff black paracord sling
- Vibration dampening adjustable weight suspension system (includes 2 stainless steel 1 oz. weights)
- Continuously curving design for balanced energy transfer
- Engineered for performance bows
- TRU•TOUCH™ Soft-Feel Technical Coating
- Patented

## MODEL SPECS

MODEL	FINISH	LENGTH	WEIGHT	MOUNTING SYSTEM	DAMPENER DESIGN	CONSTRUCTION	COMPATIBILITY	TRU•TOUCH™
<b>TG840B</b>	Black	9 in.	Adjustable from 4 to 7 oz.	Standard threaded mount	Vibration-dampening adjustable weight suspension system	Ultra-lightweight carbon composite	Fits most bows	Yes
<b>TG840J</b>	Realtree™ XTRA™							
<b>TG845B</b>	Black	7 in.	Adjustable from 5 to 7 oz.					
<b>TG845J</b>	Realtree™ XTRA™							
<b>TG845M</b>	LOST® XD							

**NEW**



ADJUSTABLE WEIGHT

CARBON-COMPOSITE CONSTRUCTION

VIBRATION / NOISE ABSORBING TECHNOLOGY

COLOR MATCHING



# DEADENATOR™ XS

RUBBER MOLDED STABILIZER

38

STABILIZERS

4.6 in. - Black  
**TG818B**



4.6 in. - XTRA™  
**TG818J**



## PRODUCT FEATURES

- Large selection of licensed camouflage patterns
- Rubber molded dampening fins increase surface area to reduce noise and vibration
- Engineered for performance hunting bows
- TRU•TOUCH™ Soft-feel Technical Coating

## MODEL SPECS

MODEL (SINGLE)	FINISH	LENGTH	WEIGHT	MOUNTING SYSTEM	DAMPENER DESIGN	CONSTRUCTION	COMPATIBILITY	TRU•TOUCH™
TG818A	Realtree™ APG™	4.6 in.	Appx. 4 oz.	Standard threaded mount	Rubber-molded dampening fins	Durable rubber-molded	Fits all bows	Yes
TG818B	Black							
TG818F	Lost AT®							
TG818J	Realtree™ XTRA™							
TG818P	Realtree™ APC™ Pink							



TRUGLO® ARCHERY / CROSSBOW 2017

VIBRATION / NOISE ABSORBING TECHNOLOGY



# BROADHEADS

Leading your arrow to an effective shot and successful hunt.



NEW

# TITANIUM X™ BROADHEADS

HIGH-PERFORMANCE TITANIUM BROADHEADS

40

BROADHEADS

## Fixed Blade Broadheads

TITANIUM X™ fixed blade broadheads are available in both an innovative 4-blade design and industry proven 3-blade configuration. Whether you want more cutting edges or more penetration, TITANIUM X delivers the strength, accuracy, and destructive power to get it done.



## Grade 5 Titanium Ferrule

Provides the strength needed to punch through bone, but also to prevent bends and dings that wear out other broadheads over time. Maximize your killing potential with broadheads that hit accurately, cut amazingly, and last longer.



*Precision broadheads for hunters, by hunters. TITANIUM X™ broadheads are spin tested and sharpness tested to ensure ultimate performance and quick kills. A CNC-machined titanium ferrule provides the unwavering strength and consistency needed to fly like a field point and punch through bone. The TRU•CUT™ titanium tip slices hide and flesh immediately upon impact and the tough stainless steel blades cut a devastating wound channel for maximum lethality and easier tracking.*

NEW

3-Blade, Fixed  
**TG3203AV**



NEW

4-Blade, Fixed  
**TG3204AV**



## PRODUCT FEATURES

- Grade 5 CNC-machined one-piece titanium ferrule
- Tough .031" thick stainless steel blades
- TRU•THRU™ precision sharpened blades for quick pass-throughs
- TRU•CUT™ one-piece titanium tip slices hide and flesh immediately upon impact
- 100 grains for optimum flight and compatibility
- Spin tested and sharpness tested for ultimate performance
- 3 Broadheads per package
- Broadhead installation wrench and one set of replacement blades included

## MODEL SPECS

MODEL	TYPE	WEIGHT	CONSTRUCTION	BLADES	CUTTING DIAMETER
<b>NEW</b> TG3203AV	Fixed blade	100 gr	Titanium ferrule and tip, Stainless steel blades	3	1 3/16 in.
<b>NEW</b> TG3204AV				4	1 3/16 in. (outer blades) 7/8 in. (inner blades)

TRUGLO® ARCHERY / CROSSBOW 2017



### Mechanical Blade Broadheads

TITANIUM X™ mechanical blade broadheads are available in a classic 2-blade design and a vicious 4-blade arrangement for maximum hemorrhaging. Torque-balancing blades expand immediately on impact and self-adjust to navigate around bones and apply the full payload to soft tissue.



**NEW**

2-Blade, Mechanical  
**TG3201AV**



**NEW**

4-Blade, Mechanical  
**TG3202AV**

### MODEL SPECS

MODEL	TYPE	WEIGHT	CONSTRUCTION	BLADES	FLIGHT DIAMETER	CUTTING DIAMETER
<b>NEW</b> TG3201AV	Mechanical blade	100 gr	Titanium ferrule and tip, Stainless steel blades	2	7/8 in.	2 3/16 in.
<b>NEW</b> TG3202AV				4	7/8 in. (outer blades) 5/8 in. (inner blades)	1 3/4 in. (outer blades) 7/8 in. (inner blades)



NEW

# TITANIUM X™ CROSSBOW BROADHEADS

HIGH-PERFORMANCE CROSSBOW BROADHEADS

42

BROADHEADS

### Grade 5 Titanium Ferrule

Provides the strength needed to punch through bone, but also to prevent bends and dings that affect accuracy and wear out other broadheads over time. Maximize your killing potential with broadheads that hit accurately, cut amazingly, and last longer.



Modern crossbows provide the energy needed to take advantage of all the cutting potential of a 4-blade broadhead – which is why we have created crossbow-specific TITANIUM X™ models to capitalize on this power by pairing our 4-blade designs with a ferrule shaped for maximizing the power of crossbow bolts.

NEW

4-Blade, Fixed  
**TG3204AX**



NEW

4-Blade, Mechanical  
**TG3202AX**



## PRODUCT FEATURES

- Grade 5 CNC-Machined one-piece titanium ferrule
- Tough .031" thick stainless steel blades
- TRU•THRU™ precision sharpened blades for quick pass-throughs
- TRU•CUT™ one-piece titanium tip slices hide and flesh immediately upon impact
- 100 grains for optimum flight and compatibility
- Spin tested and sharpness tested for ultimate performance
- 3 Broadheads per package
- Broadhead installation wrench and set of replacement blades included

## MODEL SPECS

MODEL	TYPE	WEIGHT	CONSTRUCTION	BLADES	FLIGHT DIAMETER	CUTTING DIAMETER
NEW TG3204AX	Fixed blade	100 gr	Titanium ferrule and tip, Stainless steel blades	4	1 3/16 in. (outer blades) 7/8 in. (inner blades)	1 3/16 in. (outer blades) 7/8 in. (inner blades)
NEW TG3202AX	Mechanical blade				7/8 in. (outer blades) 5/8 in. (inner blades)	1 3/4 in. (outer blades) 7/8 in. (inner blades)

TRUGLO® ARCHERY / CROSSBOW 2017



# BOW ACCESSORIES

The details that complete your archery system and give you the edge you need on the range and in the woods.



**NEW**

# BOW•JACK™

LIGHTWEIGHT, FOLDING BOW STAND

44

BOW ACCESSORIES

**NEW TG393BR Wide Model**

Features extended width grippers to hold the Mathews® HALON™ and other wide limb bows.

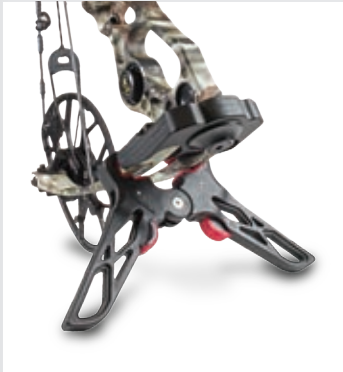

**Crossbow Compatible**

Use two BOW•JACK™ stands to create a portable crossbow stand. (Depending on crossbow model.)

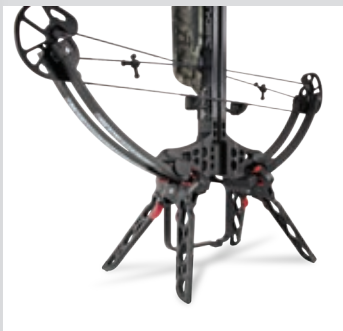

*We've all been there – your bow is optimized with the best accessories, tuned, and ready to go – then you need to set it down. Rather than laying your bow in the dirt or leaning it against something and hoping it won't fall, utilize BOW•JACK™ – the lightweight portable bow stand that goes with you and provides the support you need at the range or in the field.*



BOW•JACK™ Mini  
TG394BR



BOW•JACK™  
TG395BR

## PRODUCT FEATURES

- Lightweight and durable
- Rubber grips the limb for secure no slip fit
- Easy one-hand operation with integrated finger tabs
- Won't scratch limb surface
- Recessed spring won't snag
- Stainless steel hardware
- Fits most bows and crossbows
- Patent Pending

## MODEL SPECS

MODEL	FINISH	LENGTH	WEIGHT	APPLICATION	COMPATIBILITY
<b>NEW</b> TG393BR	Black / Red	5.8 in.	Appx. 3.9 oz.	Ideal for shorter axle-to-axle bows	Most bows and crossbows up to 3 1/8 in. limb width
TG394BR			Appx. 3.2 oz.		
TG395BR		7.25 in.	Appx. 3.5 oz.	Ideal for longer axle-to-axle bows	Most bows and crossbows up to 2 3/4 in. limb width

**BLACK**

LIGHTWEIGHT  
AND DURABLE

ONE-HAND  
OPERATION

STAINLESS STEEL  
HARDWARE

TRUGLO® ARCHERY / CROSSBOW 2017



# GREEN LED BOW LIGHT

POWERFUL LIGHT WITH PICATINNY RAIL ACCESSORY MOUNT

Great for Hog, Varmint & Predator Hunting



Accessory Mount Attaches to Stabilizer



Momentary On / Off Pressure Switch



- Universal - fits most existing stabilizers
- Ultra-bright Green LED (520nm)
- Long-life Cree® LED for worry-free operation
- High and low brightness settings (180/25 lumens)
- Maximum beam distance: approximately 160 meters
- Includes optional pressure switch for remote ON / OFF
- Includes BOW ACCESSORY MOUNT (TG85B, details below)
- Light can also be mounted to any Picatinny / Weaver-style rail for crossbows or firearms
- Waterproof up to two meters
- Runtime on high: 2 hours, runtime on low: 18 hours
- Light automatically dims when batteries reach 10%
- Includes two 3V-CR123A batteries



Black TG85BLG

## MODEL SPECS

MODEL	FINISH	LENGTH	WEIGHT	CONSTRUCTION	COMPATIBILITY	BATTERY
TG85BLG	Black	Rail is appx. 4 in.	Appx. 12 oz.	Lightweight, rigid CNC-machined aluminum	Universal	2 x 3V-CR123A Included

BLACK

WATER PROOF

ALL-ALUMINUM CONSTRUCTION



# BOW ACCESSORY MOUNT

PICATINNY RAIL ACCESSORY MOUNT

Accessory Mount Attaches to Stabilizer



- Universal - fits most existing stabilizers
- Designed for any accessories that mount to a Picatinny / Weaver-style base
- Rail can be rotated for greater versatility
- 9 Rail slots for maximum compatibility or multiple accessories



Black TG85B

## MODEL SPECS

MODEL	FINISH	LENGTH	WEIGHT	CONSTRUCTION	COMPATIBILITY
TG85B	Black	Rail is appx. 4 in.	Appx. 4 oz.	Lightweight, rigid CNC-machined aluminum	Universal

BLACK

ALL-ALUMINUM CONSTRUCTION

## NEW DUAL STABILIZER MOUNT

OFFSET MOUNT WITH SLING

- Balance your bow!
- Integrated sling mount (Bonus sling included)
- All metal construction
- No-slip meshed teeth joints
- Corrects bow tilt and roll
- Laser engraved angular markings
- Fits all stabilizers
- Fully assembled



NEW

TG87B

MODEL	FINISH	CONSTRUCTION	ADJUSTMENT	COMPATIBILITY
NEW TG87B	Black	Precision machined aluminum	Full 360° tilt and pan	All stabilizers, right-handed bows

BLACK

ALL-METAL  
CONSTRUCTION

## CENTRA™ SLING PRO

- Custom braided high-quality paracord
- Double-wide for comfort
- Extra-long length for maximum adjustability
- CNC-machined mounting adapter performs better than leather slings
- Easy to mount

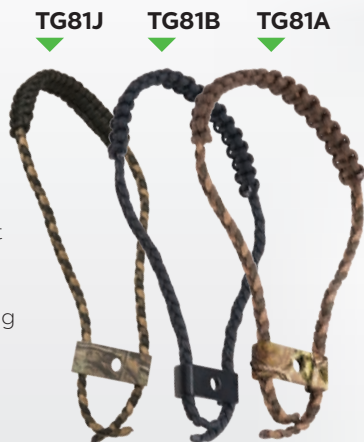

MODEL	BRACKET FINISH
TG81A	Realtree™ APG™
TG81B	Black
TG81J	Realtree™ XTRA™

BLACK

APG™

XTRA™

## CENTRA™ SLING

- Extra-long cord fits virtually all bows
- Specially braided to hold its shape
- Extra-long length for maximum adjustability
- CNC-machined mounting adapter performs better than leather slings
- Easy to mount



MODEL	STRAND COLOR	BRACKET FINISH
TG80	Camo	Black
TG80P	Pink / Black	Black

## BOW ACCESSORY KIT

- Includes 5 popular accessories
- Slotted Kisser Button
- 3 TRU•BLOCK™ string silencers
- 36 in. high-tension BCY string serving
- 5 in. finished BCY D-loop material
- 3/16 in. CENTRA™ PEEP XTREME with premium silicone tubing
- Ready to install
- Patented Kisser button design



TG601B

KISSER BUTTON MODEL	KISSER BUTTON MODEL (50-pack)	BOW ACCESSORY KIT	COLOR	CONSTRUCTION	COMPATIBILITY
TG73A	TG73AN	TG601A	Black	Soft, durable rubber	Fits all bows
TG73B	TG73BN	TG601B	Red		
TG73C	TG73CN	TG601C	Blue		
TG73D	TG73DN	TG601D	Pink		
TG73E	TG73EN	TG601E	Green		

BLACK

RED

BLUE

PINK

GREEN

## VERSA™ PEEP

- Versatile interchangeable inserts allow the shooter to customize peep for preferred size / color
- Lightweight aluminum construction
- Precision CNC-machined
- Metal peep sight is 1/4 in. dia. without insert
- Angled design for shorter axle-to-axle bows
- Patented

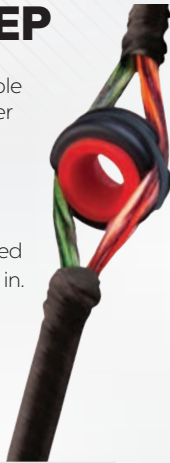

### Customize Peep Size

Change peep size / color with included interchangeable inserts.



Included with TG75X

1/8 in. 5/32 in. 3/16 in.

MODEL	COLOR	INSERT SIZES
TG75X	Black	Includes 1/8 in., 5/32 in. and 3/16 in. insert in each color

## CENTRA™ PRO•SERIES

- Lightweight aluminum construction
- Precision CNC-machined
- Angled design for shorter axle-to-axle bows
- Aperture diameter is 1/8 in., 3/16 in. or 1/4 in.
- Available in bulk



MODEL (Single)	MODEL (50-pack)	SIZE	COLOR
TG76A	TG76AN	1/8 in.	Black
TG76B	TG76BN	3/16 in.	
TG76C	TG76CN	1/4 in.	
TG76BB	TG76BBN	3/16 in.	Blue
TG76CB	TG76CBN	1/4 in.	
TG76BR	TG76BRN	3/16 in.	Red
TG76CR	TG76CRN	1/4 in.	

## CENTRA™ PEEP XTREME

- Smaller, lightweight design
- Tubing for proper positioning
- Aperture diameter is 1/8 in. or 3/16 in.



MODEL	COLOR
TG78X	1/8 in. Peep
TG78Y	3/16 in. Peep
TG78YN	3/16 in. - 50 pk.
TG78YP	3/16 in. Peep / Pink

## CENTRA™ PEEP

- Unique, angled design allows for perfect peep alignment
- Tubing for proper positioning
- Aperture diameter is 1/8 in.



MODEL	COLOR
TG78	1/8 in. Peep
TG78A	1/8 in. - 100 pk. (no tubing)
TG78B	1/8 in. - 100 pk. (with tubing)

## GLO•BRITE™ PEEP

- Performs in low-light conditions
- Adjustable green insert has three different settings
- Tubing for proper positioning
- Aperture diameter is 3/16 in.



MODEL	COLOR
TG79	3/16 in. Peep

## PEEP SILICONE TUBING

- Premium silicone peep tubing
- Resists cracking drying out for extended use
- Fits most peep sights
- Available in 5 colors



MODEL	COLOR	QUANTITY
TG77SA	Black	25' Bulk roll
TG77SB	Red	
TG77SC	Blue	
TG77SD	Pink	
TG77SE	Green	



## REPLACEMENT FIBERS

- Replacement fiber-optic material for firearm and archery sights
- Efficient light transmission and vibrant color
- Available in a wide variety of colors and sizes



MODEL	DIAMETER	COLOR / QUANTITY
TG59R	.029" (0.75mm)	Red (1)
TG59G	.029" (0.75mm)	Green (1)
TG59Y	.029" (0.75mm)	Yellow (1)
TG59M	.029" (0.75mm)	Red (1), Green (1) Yellow (1)

MODEL	LENGTH	DIAMETER	COLOR / QUANTITY
TG08A	9 in.	.029" (0.75mm)	Red (1), Green (2), Yellow (2)
TG08D		.019" (0.50mm)	
TG08M		Multi-diameter: .019" / .029" (0.50mm) / (0.75mm)	Red (1x .019", 1x .029"), Green (1x .019", 1x .029"), Yellow (1x .019", 1x .029")
TG09B	5.5 in.	.010" (0.25mm)	Blue (5)
TG09G		.010" (0.25mm)	Green (5)
TG05A		.029" (0.75mm)	Red (1), Green (1), Yellow (1), Ruby Red (1), Orange (1)
TG05B		.040" (1mm)	
TG05C		.060" (1.5mm)	
TG05D	.019" (0.50mm)		
TG05E	.078" (2mm)	Ruby Red (3), Green (2)	
TG05F	.100" (2.5mm)		
TG05CD	.060" (1.5mm)	DUAL-COLOR Red center / Green outside (5)	
TG05ED	.078" (2mm)		
TG05FD	.100" (2.5mm)		

Please note: Fiber diameter and length may vary per sight or installation application. Please check actual sight model before ordering.

## TRITIUM + FIBER-OPTIC PINS

- The most revolutionary innovation since we introduced fiber-optic sight pins
- Tritium source keeps the fiber bright under any lighting condition, including complete darkness
- Fits 3/16 in. slotted sights
- Perfect transition through all lighting conditions
- Glow-in-the-dark
- Uses the brightest Swiss tritium available
- Patented

TFD®



MODEL	DIAMETER	COLOR / QUANTITY
TG19G	.029" (0.75mm)	Green (1)
TG19Y		Yellow (1)
TG20G	.040" (0.75mm)	Green (1)
TG20Y		Yellow (1)

## PRO•WRAP™ PINS

- Machined, black zinc-coated hardened brass
- Fits 3/16 in. slotted sights
- Wrapped fiber provides greater brightness
- Thinner pin body (no "shoulder") for better visibility



MODEL	DIAMETER	COLOR
TG844WG	.019"	Green
TG844WR		Red
TG844WY		Yellow
TG842WG	.029"	Green
TG842WR		Red
TG842WY		Yellow

## PRO•DOT™ PINS

- Unique, precision-machined all-steel pins
- Fits 3/16 in. slotted sights
- Our original looped fiber sight pins

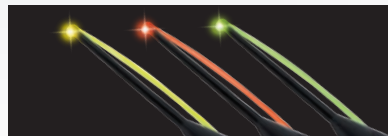

MODEL	DIAMETER	COLOR
TG841G	.019"	Green
TG841R		Red
TG841Y		Yellow
TG842G	.029"	Green
TG842R		Red
TG842Y		Yellow
TG843G	.040"	Green
TG843R		Red
TG843Y		Yellow

## BRITE•DOT™ PINS

- Machined, black zinc-coated hardened brass
- Fits 3/16 in. slotted sights
- Wrapped fiber provides greater brightness

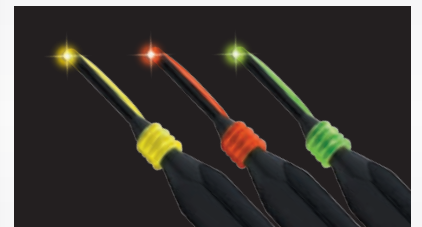

MODEL	DIAMETER	COLOR
TG851G	.029"	Green
TG851R		Red
TG851Y		Yellow
TG852		3-pack (Green, red, yellow)



## NEW TRU•LITE™ PRO

- Universal – fits most popular sight brands
- Blue LED
- 3 brightness levels controlled by distinctive twist-click knob
- Long battery life
- Easy ON / OFF and brightness selection
- Replaceable battery (TG988G, CR927)
- Battery included
- Sight housing adapters included



TG57

NEW

MODEL	DESCRIPTION
-------	-------------

NEW TG57 Blue LED Rotary Light, 3 brightness levels

## Sight Housing Adapters

All TRU•LITE™ series sight lights include adapters fit 3/8-32, 3/8-36 and 7/16-20 threads. Fits sights by Copper John™, PSE™, Spot-Hogg®, Trophy Ridge™, TRUGLO® and others.



3/8 in. 36 threads 7/16 in. 20 threads

Adapter plate

## TRU•LITE™ XTREME

- Adjustable rheostat allows for infinite brightness settings
- Violet LED
- Replaceable batteries (TG988A, 1.5VLR41)
- Battery included
- Sight housing adapters included



TG56

MODEL	DESCRIPTION
-------	-------------

TG56 Violet LED Light, Rheostat brightness control

## TRU•LITE™

- Push-button ON / OFF
- Violet LED
- Replaceable batteries (TG988A, 1.5VLR41)
- Battery included
- Sight housing adapters included



TG55

MODEL	DESCRIPTION
-------	-------------

TG55 Violet LED Light, Push-button

## HUNTER'S LITE™

- Multi-functional task light
- Hands-free operation
- Dual-position ON / OFF switch
- Flexible neck retains desired position
- Includes removable clip for convenient attachment to hats, belts, or jackets
- Attaches directly to your sight, bow or other sporting equipment
- Super-bright blue LED



TG982B

MODEL	LIGHT COLOR
-------	-------------

TG982B Blue

## ARROW PULLER

- Easy-on arrow opening
- Contoured design for better grip
- Bell housing increases pulling force
- Solid rubber puller construction
- Quick release hanger clip included
- Reinforced hinge for long life
- Simple one-hand operation
- Made for all arrow types



TG398B

MODEL	COLOR	COMPATIBILITY
TG398B	Black	All arrow types

## TRU•BLOCK™ STRING SILENCERS

- Reduces string noise and vibration
- Technical weather-resistant material
- Lightweight / durable design
- Engineered for hunting and target bows
- Designed to fit all bowstrings



TG830B

TG830R

MODEL (4-pack)	MODEL (100-pack)	COLOR
TG830B	TG830N	Black
TG830R	TG830RN	Red

## REPLACEMENT BATTERIES

- Replacement batteries for TRUGLO® and other brand archery sights, lights and electro-optical sights

MODEL	DESCRIPTION
TG988A	For models TG55 and TG56 (3 per pack) (1.5V-LR41)
TG988B	For HUNTER'S LITE™ model TG982B (2 per pack) (3V-CR2016)
TG988C	For all TRUGLO® Dot Optics and Illuminated Scopes (2 per pack) (3V-CR2032)
TG988D	For push-button light (3 per pack) (1.5V-SR60)
TG988F	For GREEN LED Bow Light (3V-CR123A)
TG988G	For TRU•LITE™ PRO model TG57 (2 per pack) (TG927, 3V Lithium)

TG988C





# TRU•BRITE™

10x42MM OPEN-BRIDGE BINOCULARS

### Neoprene Strap Included

Comfortable padded neck strap supports your TRU•BRITE™ binoculars for easy access.



### Single Wheel Adjustment

Click adjustment wheel back to set diopter adjustment, then lock-in your diopter setting and click the wheel forward to adjust focus.



TG91042G



## PRODUCT FEATURES

- Compact roof / BAK-4 prism design with phase coated prisms
- Single, ergonomic adjustment wheel for both focus and diopter settings
- Lockable diopter
- Long eye relief for use with eyewear
- Twist-up eyecups with click stops
- High transmission silver coating on prisms
- Textured surface provides a non-slip grip in all weather conditions
- Non-reflective matte finish
- Includes protective case

## MODEL SPECS

<b>MODEL</b>	<b>TG91042G</b>
<b>MAGNIFICATION</b>	10x
<b>OBJECTIVE DIAMETER</b>	42mm
<b>FOV (ANGULAR)</b>	6.5 degrees
<b>FOV (FT @ 1000 YDS)</b>	345
<b>CLOSE FOCUS</b>	8.2 feet
<b>EXIT PUPIL DIAMETER</b>	4.20mm
<b>INTERPUPILLARY DISTANCE</b>	58-73mm
<b>EYE RELIEF</b>	15mm
<b>DIOPTRIC COMPENSATION</b>	-4 / +4
<b>DIOPTRIC ADJUSTMENT</b>	Lockable diopter / center adjustment wheel
<b>PRISM TYPE / COMPOSITION</b>	Roof / BAK-4 Glass
<b>COATING</b>	Fully multi-coated / phase coated prisms
<b>PROTECTIVE CASE</b>	Yes
<b>NEOPRENE SHOULDER STRAP</b>	Yes
<b>UNIT DIMENSIONS (HxWxD)</b>	146x128x51mm
<b>WEIGHT (OUNCES)</b>	23.77

WATER  
PROOF

SHOCK  
RESISTANT

NITROGEN  
GAS-FILLED

FOG  
PROOF

MATTE  
FINISH



# CROSSBOW

Optics and accessories.



# 4X32 COMPACT

ILLUMINATED-RETICLE CROSSBOW SCOPE

LIMITED  
**LIFETIME**  
WARRANTY

## DUAL•COLOR

TG8504B3L

### ILLUMINATED RANGE FINDER

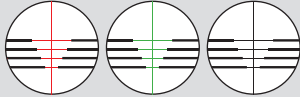

4 x 32mm - Black  
**TG8504B3L**

TG8504B3

### RANGE FINDER

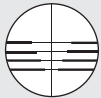

4 x 32mm - Black  
**TG8504B3**

## Replacement Batteries

(3V-CR2032) Battery included with illuminated model.

See page 58 for replacement batteries.

**TG988C**



## PRODUCT FEATURES

- Includes DUAL•COLOR illuminated reticle (TG8504B3L)
- Reticle can be used in black without illumination
- Generous 4 in. eye relief
- Fully-coated lenses provide maximum brightness, clarity and contrast
- Durable, scratch-resistant, non-reflective matte finish
- Includes Weaver-style rings

## MODEL SPECS

MODEL	POWER / OBJECTIVE	RETICLE TYPE	FINISH	CONSTRUCTION	ADJUSTABLE BRIGHTNESS	WINDAGE / ELEVATION	LENS CAPS	RINGS	BATTERY
TG8504B3L	4 x 32mm	Range finder / trajectory compensating	Anodized matte black	One-piece aircraft quality aluminum tube	Rheostat controlled	Durable leaf spring - fingertip adjustments	Standard	Weaver-style rings included	3V-CR2032 Included
TG8504B3			Realtree™ APG™		-				-
TG8504C3					-				-

APG™ ANODIZED MATTE BLACK

DUAL  
COLOR

WATER  
RESISTANT

SHOCK  
RESISTANT

NITROGEN  
GAS-FILLED

FOG  
PROOF

RINGS  
INCLUDED

LIMITED LIFETIME  
WARRANTY



# CROSS•TEC™ 4X32MM

ILLUMINATED-RETICLE CROSSBOW SCOPE

54

CROSSBOW

## DUAL•COLOR

TG8504AL4

ILLUMINATED  
BOLT-DROP-COMPENSATING /  
RANGE FINDING RETICLE



4 x 32mm - Black  
**TG8504AL4**

TG8504A

BOLT-DROP-COMPENSATING /  
RANGE FINDING RETICLE



4 x 32mm - Black  
**TG8504A**

### Replacement Batteries

(3V-CR2032) Battery included with illuminated model.

See page 58 for replacement batteries.

**TG988C**



4x fixed magnification gives hunters the precision needed for accuracy at the end of crossbow range while maintaining the speed and wide field of view that is advantageous for close-range hunting. CROSS•TEC™ builds on this concept with a compact design, multi-coated lenses, and a glass etched reticle with available red and green illumination.

## PRODUCT FEATURES

- DUAL•COLOR illuminated reticle allows choice of red or green for faster target acquisition in low-light conditions (TG8504AL4)
- Waterproof / fog-proof / nitrogen gas-filled
- Fully-coated lenses provide maximum brightness, clarity and contrast
- Adjustable rheostat brightness control
- Durable leaf-spring click adjustments for windage and elevation
- Wide field of view
- 1/2-MOA Windage / Elevation adjustments
- Weaver-style rings included
- Includes 3V-CR2032 battery

## MODEL SPECS

MODEL	POWER / OBJECTIVE	RETICLE TYPE	FINISH	CONSTRUCTION	ADJUSTABLE BRIGHTNESS	WINDAGE / ELEVATION	LENS CAPS	RINGS	BATTERY
TG8504AL4	4 x 32mm	Range finder / trajectory compensating	Anodized matte black	One-piece aircraft quality aluminum tube	Rheostat controlled	Durable leaf spring - fingertip adjustments	Standard	Weaver-style rings included	3V-CR2032 Included
TG8504A4					-				-

**ANODIZED MATTE BLACK**

DUAL  
COLOR

WATER  
RESISTANT

SHOCK  
RESISTANT

NITROGEN  
GAS-FILLED

FOG  
PROOF

RINGS  
INCLUDED

TRUGLO® ARCHERY / CROSSBOW 2017



# TRITON™ 30MM

LIMITED LIFETIME WARRANTY

TRI•COLOR

## CROSSBOW TRI•COLOR DOT SIGHT

- Three choices of reticle color for contrast against any target / background (red, green or blue)
- 30mm objective lens
- Remote momentary ON / OFF pressure switch included
- Flip-up lens caps / lanyard system
- Integrated Weaver-style mounting system
- Includes all the award-winning features of our TRADITIONAL Red•Dot Series



Black  
TG8230B3

### Included Pressure Switch

Remote ON /OFF momentary pressure switch puts the power of the TRITON™ at your fingertips.



### DESCENDING DIAMETER DOT RETICLE



### Replacement Batteries

(3V-CR2032) Battery included. See page 58 for replacement batteries.

TG988C



## MODEL SPECS

MODEL	POWER / OBJECTIVE	RETICLE TYPE	FINISH	CONSTRUCTION	ADJUSTABLE BRIGHTNESS	WINDAGE / ELEVATION	LENS CAPS	BATTERY
TG8230B3	1x 30mm	TRI•COLOR Descending Diameter Dots	Anodized matte black	Lightweight aircraft-grade aluminum	Rheostat controlled / Pressure switch ON / OFF	Click windage and elevation	Flip-up	3V-CR2032 Included

ANODIZED MATTE BLACK

TRI COLOR

WATER RESISTANT

SHOCK RESISTANT

FOG PROOF

INCLUDED PRESSURE SWITCH

LIMITED LIFETIME WARRANTY



# 30MM TRADITIONAL

LIMITED LIFETIME WARRANTY

## CROSSBOW RED DOT SIGHT

- Descending diameter dot reticle for multi-distance shooting (Smaller dot for longer shots)
- Unlimited eye relief
- Wide field of view
- Flip-up lens caps / lanyard system
- Lightweight / easy to mount
- Integrated Weaver-style mounting system



Black  
TG8030B3

### DESCENDING DIAMETER DOT RETICLE



### Replacement Batteries

(3V-CR2032) Battery included. See page 58 for replacement batteries.

TG988C



## MODEL SPECS

MODEL	POWER / OBJECTIVE	RETICLE TYPE	FINISH	CONSTRUCTION	ADJUSTABLE BRIGHTNESS	WINDAGE / ELEVATION	LENS CAPS	BATTERY
TG8030B3	1x 30mm	Descending Diameter Dots	Anodized matte black	Lightweight aircraft-grade aluminum	Rheostat controlled	Click windage and elevation	Flip-up	3V-CR2032 Included
TG8030C3			Realtree™ APG™					

APG™ ANODIZED MATTE BLACK

WATER RESISTANT

SHOCK RESISTANT

FOG PROOF

LIMITED LIFETIME WARRANTY



# DUAL•COLOR

## CROSSBOW DUAL•COLOR OPEN DOT SIGHT

LIMITED  
LIFETIME  
WARRANTY

Black  
TG8380B4

### TRAJECTORY COMPENSATING SYSTEM

Four selectable reticles for different speed crossbows

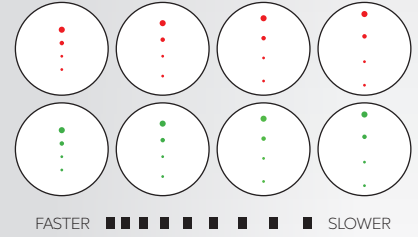

DUAL•COLOR

### MODEL SPECS

MODEL	POWER / OBJECTIVE	RETICLE TYPE	FINISH	CONSTRUCTION	ADJUSTABLE BRIGHTNESS	WINDAGE / ELEVATION	BATTERY
TG8380B4	1x 34mm	DUAL•COLOR Descending Diameter Dots	Anodized matte black	Lightweight CNC-machined aluminum	Rheostat controlled	Click windage and elevation	3V-CR2032 Included

ANODIZED MATTE BLACK

DUAL  
COLOR

WATER  
RESISTANT

SHOCK  
RESISTANT

LIMITED LIFETIME  
WARRANTY



# CROSSBOW OPTICS CHART

## DOT•OPTICS

SERIES / MODEL	LENGTH (inches)	LENGTH WITH SUNSHADE (inches)	WEIGHT (ounces)	POWER / OBJECTIVE LENS (x / mm)	OPTIC HEIGHT**	CO-WITNESS HEIGHT*	FIELD OF VIEW (feet@100yards)	EYE RELIEF (inches)	PARALLAX SETTING (in yards)	CLICK VALUE (inches@100yds)	RANGE OF ADJUSTMENT (inches@100yds)	RETICLE COLOR	RETICLE TYPE	BATTERY
TG8030B3/C3	3.82	—	7.0	1x30	1.59	1.00	68	Unlimited	30	1	30	Red	3 Dot, Descending Diameter	CR2032
TG8380B4	3.27	—	5.5	1x34	2.00	1.53	74	Unlimited	30	1	30	Red, Green	4 Dot, Descending Diameter	CR2032
TG8230B3	3.85	—	8.0	1x30	1.61	1.02	68	Unlimited	30	1	30	Red, Green, Blue	3 Dot, Descending Diameter	CR2032

\* Measured as the height between the top of the Weaver / Picatinny rail and the center of the optic.

\*\* Measured from top of Weaver / Picatinny rail to the top of optic (excluding turrets, buttons, etc)

## SCOPES

SERIES / MODEL	DIMENSIONS (inches)							WEIGHT (ounces)	MAG. (x)	OBJ. DIA. (mm)	FIELD OF VIEW (feet@100yards)		EYE RELIEF (inches @.75 diopter)		PARALLAX SETTING (yards)	CLICK VALUE (inches @100yds)	RANGE OF ADJUSTMENT (inches, all directions from center @100yds)	RETICLE TYPE	BATTERY
	A	B	C	D	E	F	G				High Power	Low Power	High Power	Low Power					
TG8504B3/C3	9.80	3.80	1.60	1.06	1.46	1.46	1.00	12.5	4	32	—	20.79	—	5.50	0.25	0.30	300	Trajectory / Ranging	—
TG8504B3L	9.80	3.80	1.60	1.06	1.67	1.46	1.00	15.4	4	32	—	20.79	—	5.50	0.25	0.30	300	2 Color IR Trajectory / Ranging	CR2032
TG8504A	8.07	3.09	0.84	1.01	1.61	1.54	1.00	12.5	4	32	5.8°	—	4.50	—	100	0.50	400	Duplex	—
TG8504AL	8.06	3.24	1.11	0.97	1.58	1.54	1.00	13.2	4	32	5.6°	—	4.50	—	100	0.50	400	IR Duplex	CR2032







NEW

# HIP•SHOT™

CROSSBOW SHOOTING REST



### Universal Thread Pattern

HIP•SHOT™ can also be used as a camera, light or optics support.



An unsupported shot with a crossbow is often uncomfortable, inaccurate, or even dangerous. HIP•SHOT™ Crossbow Shooting rest provides a stable platform that easily goes with you on any hunt. By bracing against your hip or the ground, you can take advantage of a stable 3-point support that works while sitting, standing or kneeling. Compact and lightweight, HIP•SHOT is a trusted hunting companion for any crossbow shooter.

### Wrist Strap

Adjustable wrist strap keeps HIP•SHOT at close reach with a buckle that easily attaches to a pack or belt.



## PRODUCT FEATURES

- Increases stability for greater accuracy
- Great for tree stands and ground blinds
- Makes large / heavy crossbows easier to shoot
- Comfortably shoot from standing, sitting, kneeling or prone positions
- Vertical grip moves hand safely away from crossbow rail
- Lightweight folding design stores easily in a pack or on a belt
- Telescoping design fits all sized shooters
- Fully assembled



NEW

← TG8930XB

## MODEL SPECS

MODEL	LENGTH	WEIGHT	CONSTRUCTION
NEW TG8930XB	Adjustable from 20-29 in.	10 oz.	Lightweight aluminum and composite materials

## NEW CROSSBOW BOLT PULLER

Modern crossbows lodge bolts deep inside targets – easily grip and pull bolts from targets without damaging the shafts or vanes.

- Easy-on bolt opening
- Compact contoured design for maximum pulling power
- Bell housing increases pulling force
- Solid rubber puller construction
- Quick release hanger clip included
- Reinforced hinge for long life
- Simple one-hand operation
- Compatible with carbon & aluminum crossbow bolts



NEW

TG397B

MODEL	COLOR	COMPATIBILITY
-------	-------	---------------

NEW TG397B	Black	All bolt types
------------	-------	----------------

## CROSS•TEC™ STRING SILENCERS

- Quick and easy installation – no bow press required!
- Triple-arm design for increased 3D dampening
- Reduces string noise and vibration
- Lightweight and durable
- Engineered for crossbows
- Weather-resistant material



TG832B

MODEL (4-PACK)	COLOR	COMPATIBILITY
----------------	-------	---------------

TG832B	Black	All crossbows
--------	-------	---------------

## REPLACEMENT BATTERIES

- Replacement batteries for TRUGLO® Illuminated crossbow optics.

TG988C



MODEL	DESCRIPTION
-------	-------------

TG988C	For all TRUGLO® Crossbow Dot Optics and Illuminated Scopes (2 per pack) (3V-CR2032)
--------	---



# BOWFISHING

Extend the thrill of bowhunting all year long!



NEW

# SPEED•SHOT™

PERFORMANCE BOWFISHING ARROW

60

BOWFISHING

## SPEED•SHOT™ BOWFISHING POINT

250gr stainless steel point (TG145A1) included.



TG140F3G



## SLIDE SAFETY SYSTEM

Safely tie your arrow into your retrieval system to provide a smooth and accurate shot, followed by a consistent and reliable retrieve. Included on model TG140C1G.



## PRODUCT FEATURES

- Premium grade, hardened stainless steel tip
- 250 grain point with pivoting barb for quick fish removal and improved penetration
- Premium fiberglass high-visibility fluorescent colored shaft
- Ultra-slim nock diameter improves accuracy
- Most arrow slides can be easily installed over the nock
- Patented

## AVAILABLE ACCESSORIES

MODEL	DESCRIPTION
TG146A1	Replacement Tips (2-Pack)
TG144A1	Replacement Bowfishing Nocks (6-Pack)

## MODEL SPECS

MODEL	POINT	SHAFT	SLIDE SYSTEM	NOCK
TG140F3G	SPEED•SHOT stainless steel point	Fluorescent green fiberglass	Pre-drilled for easy installation	Fluorescent bowfishing nock
TG140C1G			Slide / Stop / Nock safety system (TG147A1)	

NEW

FLUORESCENT GREEN



# SPRING•SHOT™

COIL SPRING BOWFISHING ARROW REST

On a good bowfishing trip, mud, water and even fish slime inevitably gets on your gear. The SPRING•SHOT™ patented stainless steel coil spring shucks off water and muck for safe, reliable and accurate shooting in even the nastiest conditions.

- Fast and easy arrow loading
- Revolutionary ultra-durable stainless steel coil spring provides full arrow containment
- Full windage / elevation adjustment
- For left and right-handed bows
- Patented



TG690B1

MODEL SPECS

MODEL	DESCRIPTION
TG690B1	Full 360° containment-style bowfishing rest

BLACK



# SPRING•SHOT™ BOWFISHING KIT

BOWFISHING ACCESSORY SYSTEM

Convert your bow to a dedicated bowfishing setup with the essentials – SPRING•SHOT™ Bowfishing Kit includes two SPEED•SHOT™ arrows with nocks, points, and slide systems pre-installed and our patented SPRING•SHOT arrow rest.

- Includes two SPEED•SHOT™ bowfishing arrows (See TG140F3G for details) and SPRING•SHOT™ bowfishing arrow rest (See TG690B1 for details).
- Pivoting barb for quick fish removal and improved penetration
- Revolutionary spring-coil arrow rest
- Patented



TG140F1G

MODEL SPECS

MODEL	DESCRIPTION
TG140F1G	Bowfishing Kit

BLACK



# ACCU•X™

CAPTURE-STYLE BOWFISHING ARROW REST

62

BOWFISHING

### Waterproof and Durable

With nylon brushes, a composite body, and stainless steel hardware, ACCU•X™ provides an accurate and sturdy rest for your next bowfishing adventure.



TG680B1

## PRODUCT FEATURES

- Fast and easy arrow loading
- Replaceable waterproof brushes
- Ultra-lightweight and compact design
- Full windage / elevation adjustment
- For left and right-handed bows

## MODEL SPECS

MODEL	DESCRIPTION
TG680B1	Nylon brush capture-style bowfishing rest

BLACK

## BOWFISHING NOCKS

- Contoured string groove improves arrow release
- High-visibility green stands out in a variety of water and lighting conditions
- Designed specifically for tapered bowfishing arrows

TG144A1



MODEL	DESCRIPTION
TG144A1	Bowfishing Nocks (6-Pack)

## STRING FINGER GUARDS

- Increases comfort and accuracy while reducing nock pinch
- Provides consistent arrow nocking point
- Includes installation tool

TG390G1



MODEL	DESCRIPTION
TG390G1	String Finger Guards

TRUGLO® ARCHERY / CROSSBOW 2017



# BOWFISHING SLIDES, STOPS & NOCKS

ARROW-SLIDE SAFETY SYSTEM

## Safe and Accurate

The arrow slide stays in front of the riser, preventing dangerous tangles, snags, or contact with the wrong side of the arrow rest.

When fired, the slide moves back and the line trails directly behind the arrow – following the shot without influencing it.



TG147A1

## PRODUCT FEATURES

- Includes three nocks, three arrow slides and three slide stops
- Balanced 360° slide stop
- Compatible with fiberglass or carbon arrows
- Nocks fit 5/16 in. diameter tapered bowfishing arrows
- Patented

## MODEL SPECS

MODEL	DESCRIPTION
TG147A1	Arrow slide safety system (Slides, Stops & Nocks)

## SPEED•SHOT™ BOWFISHING POINT

Whether using TRUGLO® arrows, or upgrading other arrows, bowfishermen can now take advantage of our 5-sided hardened stainless steel point, complete with reversible barb for easy fish removal.

- 250 grain, premium grade, hardened stainless steel tip with pivoting barb
- Pivoting barb for quick fish removal and improved penetration



TG145A1

## SPEED•SHOT™ REPLACEMENT TIPS

Unfortunately, everyone misses at some point, occasionally hitting rocks and damaging tips – which is why we made it as easy as possible to replace tips quickly and get back in the water.

- Elongated tip improves penetration
- Hardened stainless steel stays sharp and resists rust



TG146A1

MODEL	DESCRIPTION
TG145A1	SPEED•SHOT™ Bowfishing Point

MODEL	DESCRIPTION
TG146A1	SPEED•SHOT™ Bowfishing Point Replacement Tips (2-Pack)

# TRUGLO®

WHEN BRIGHTNESS COUNTS™

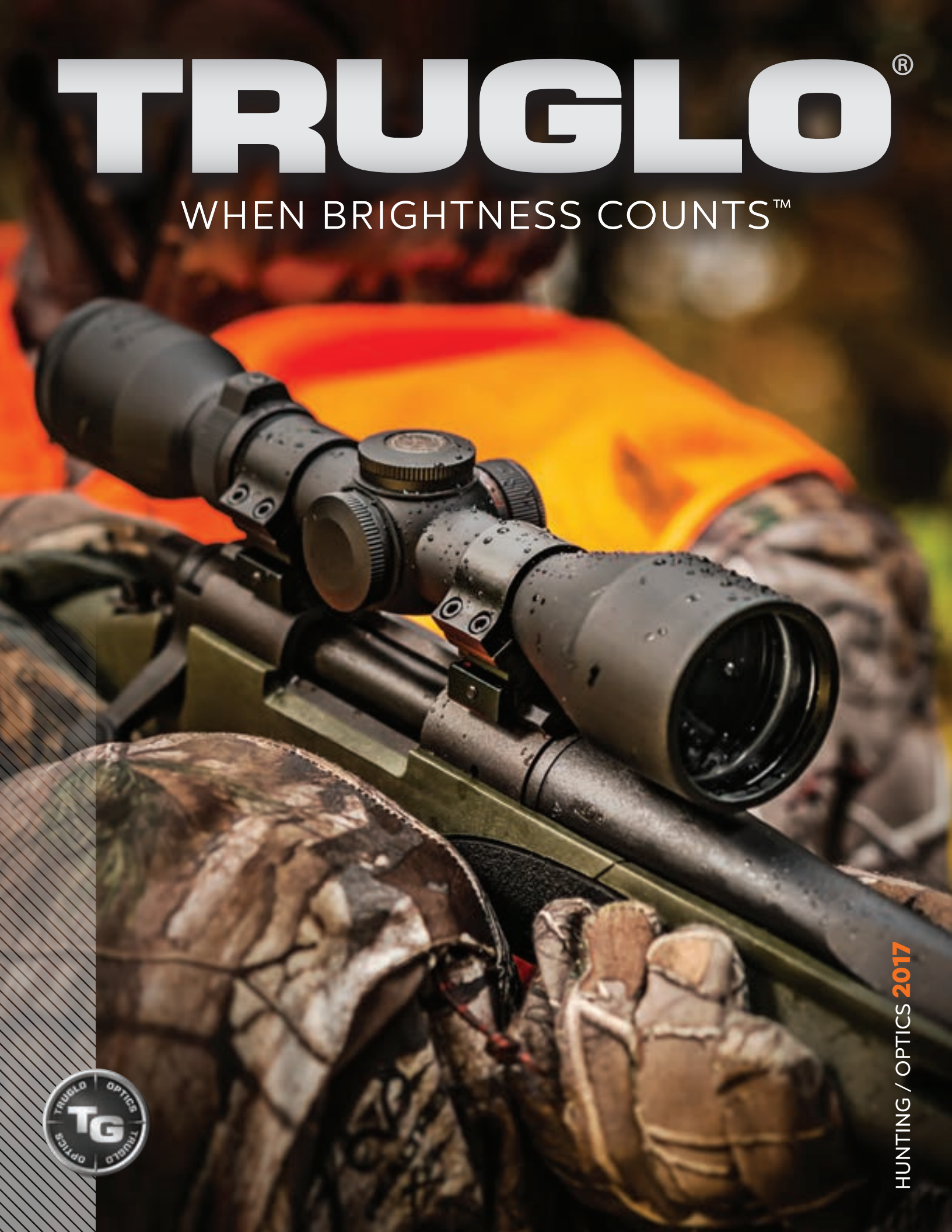

HUNTING / OPTICS 2017



# TABLE OF CONTENTS

## DOT•OPTICS

TRITON™ 30MM TRI•COLOR DOT SIGHT .....	4-5
TRITON™ 28MM MULTI-RETICLE TRI•COLOR OPEN DOT SIGHT .....	6
TRITON™ 20MM ULTRA-COMPACT TRI•COLOR DOT SIGHT .....	7
TRU•BRITE™ OPEN DOT SIGHTS .....	8
DUAL•COLOR OPEN DOT SIGHTS .....	9
GOBBLE•STOPPER™ DUAL•COLOR TURKEY HUNTING SIGHTS .....	10
MULTI•RETICLE DUAL•COLOR DOT SIGHTS .....	11
DUAL•COLOR & TRADITIONAL DOT SIGHTS .....	12-13

## SCOPES

TRU•BRITE™ 30 HUNTER .....	15
TRU•BRITE™ XTREME IR RIFLE .....	16
TRU•BRITE™ XTREME IR MUZZLELOADER .....	17
HUNT•TEC™ 4 x 32 COMPACT .....	18
4 x 32MM COMPACT .....	19
TRUSHOT™ RIFLE SCOPE SERIES .....	20-21

## FIBER•OPTIC SIGHTS

<b>NEW</b> TURKEY HUNTING SHOTGUN SIGHTS .....	23-24
WING & CLAY SHOTGUN SIGHTS .....	25-28
SLUG / RIFLE / MUZZLELOADER SIGHTS .....	29-31
RIMFIRE / AIRGUN SIGHTS .....	32

## CHOKE TUBES

STRUT•STOPPER™ XTREME TURKEY CHOKE COMBO .....	34
GOBBLE•STOPPER™ XTREME TURKEY CHOKE COMBO .....	34
TITAN™ ADJUSTABLE CHOKE TUBE .....	35

## TARGETS & ACCESSORIES

TRU•SEE™ HIGH VISIBILITY REACTIVE / SPLATTER TARGETS .....	37
TRU•BRITE™ 10 x 42MM OPEN BRIDGE BINOCULARS .....	38
HUNTER'S LITE™ .....	38
GLO•BRITE™ PAINT KITS .....	38
REPLACEMENT FIBERS .....	39
REPLACEMENT BATTERIES .....	39
PICATINNY RAIL MOUNT RISERS / ADAPTER .....	39

## CHARTS

DOT•OPTICS TECHNICAL SPECIFICATIONS .....	40
SCOPE TECHNICAL SPECIFICATIONS .....	41
GUN MODEL COMPATIBILITY CHART .....	42-43



# DOT•OPTICS

Whether you are hunting turkeys with a shotgun, hogs with a rifle, or plinking targets at the range, TRUGLO® DOT•OPTICS offer the ideal combination of brightness and speed for close and medium-range shooting.



# TRITON™ 30MM

TRI•COLOR DOT SIGHT

LIMITED  
**LIFETIME**  
WARRANTY

4

DOT•OPTICS

## TRI•COLOR

### 3-MOA CENTER DOT

Illuminated circle equals 24" at 30 yards.



TRITON™ Series dot optics are designed for every situation – any season, any target. TRI•COLOR reticle illumination gives you options for the ultimate contrast against any background while the ON / OFF pressure-sensitive switch will make your movements virtually undetectable. TRITON dot optics offer a bright and versatile targeting system, providing the perfect combination of comfort, clarity, and control.

### PERFECT FOR TURKEY HUNTING

(TG8230GB) Included sunshade, pressure switch and specialized reticle make for a deadly combination in the turkey woods.



30mm - Black  
**TG8230GB**

### Replacement Batteries

(3V-CR2032) Battery included.

See page 39 for replacement batteries.

### TG988C



### Included Pressure Switch

Remote ON / OFF momentary pressure switch puts the power of the TRITON™ at your fingertips.



## PRODUCT FEATURES

- Three choices of reticle color for contrast against any target / background (red, green or blue)
- 30mm objective lens
- Remote momentary ON / OFF pressure switch included
- Flip-up lens caps / lanyard system
- Integrated Weaver-style mounting system
- Model TG8230GB includes a detachable, extended sunshade that eliminates glare from the front lens
- Model TG8230GB includes a precise 3-MOA Center Dot reticle – perfect for turkey hunting
- Includes all the award-winning features of our TRADITIONAL Red•Dot Series (see page 12)



**TRI•COLOR**

5-MOA DOT



### Riser Mounts

Additional mounting options available. See page 39 for details.



30mm - Black  
**TG8230B**



## MODEL SPECS

MODEL	POWER / OBJECTIVE	RETICLETYPE	FINISH	CONSTRUCTION	ADJUSTABLE BRIGHTNESS	WINDAGE / ELEVATION	LENS CAPS	BATTERY
TG8230GB	1x 30mm	3-MOA TRI•COLOR Center Dot	Anodized matte black	Lightweight CNC-machined aluminum	Rheostat controlled Pressure switch ON / OFF	Click windage and elevation	Flip-up	3V-CR2032 Included
TG8230B		5-MOA TRI•COLOR Dot						

**ANODIZED MATTE BLACK**

TRI  
COLOR

WATER  
RESISTANT

SHOCK  
RESISTANT

FOG  
PROOF

INCLUDED  
PRESSURE SWITCH

LIMITED LIFETIME  
WARRANTY



# TRITON™ 28MM

MULTI-RETICLE TRI•COLOR OPEN DOT SIGHT

LIMITED  
**LIFETIME**  
WARRANTY

6

DOT•OPTICS

## TRI•COLOR

### 5-MOA DOT



### 2.5-MOA DOT

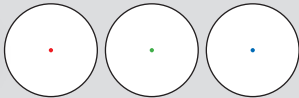

### 5-MOA CENTER DOT



### 2.5-MOA CENTER DOT



### Detachable Sunshade

Lightweight aluminum sunshade eliminates glare from the lens.



### Replacement Batteries

(3V-CR2032) Battery included.  
See page 39 for replacement batteries.

### TG988C



This compact TRITON™ reflex sight is designed to easily adapt to a wide variety of shooting and lighting conditions. Along with the innovative TRI•COLOR technology, this sight also includes the ability to choose between four reticle patterns, each with individual brightness settings. In addition to being compatible with any Picatinny or Weaver rail, TRITON 28mm sits at the ideal height for most modern sporting rifles.

28mm - Black  
**TG8365B**



### MSR CO-WITNESS HEIGHT

TRITON™ 28mm sits at the ideal height for flattop AR-15s and other modern sporting rifles.

## PRODUCT FEATURES

- Quickly toggle between 4 reticles with the intuitive rotary selector switch
- Lightweight / compact design
- Unlimited eye relief
- Wide field of view
- Anti-reflective coating on target side
- Parallax free from 30 yards
- Included detachable sunshade
- Integrated Weaver-style mounting system
- Ideal for shotguns, handguns, rifles, muzzleloaders, airguns and crossbows

## MODEL SPECS

MODEL	POWER / OBJECTIVE	RETICLE TYPE	FINISH	CONSTRUCTION	ADJUSTABLE BRIGHTNESS	WINDAGE / ELEVATION	BATTERY
TG8365B	1x 28mm	TRI•COLOR Multi-reticle	Anodized matte black	Lightweight CNC-machined aluminum	Rheostat controlled	Click windage and elevation	3V-CR2032 Included

**ANODIZED MATTE BLACK**

TRI  
COLOR

MULTI  
RETICLE

WATER  
RESISTANT

SHOCK  
RESISTANT

LIMITED LIFETIME  
WARRANTY



# TRITON™ 20MM

ULTRA-COMPACT TRI•COLOR DOT SIGHT

LIMITED  
**LIFETIME**  
WARRANTY

The ultra-lightweight, compact 20mm TRITON™ sight also features our innovative TRI•COLOR technology with individual brightness settings. This sight can be adapted to a variety of weapon systems, providing a wide range of options with minimal weight and bulk.

### TRI•COLOR

#### 5-MOA DOT



#### Replacement Batteries

(3V-CR2032) Battery included.

See page 39 for replacement batteries.

#### TG988C



20mm - Black  
**TG8020B**

## PRODUCT FEATURES

- Three choices of reticle color for contrast against any target / background (red, green or blue)
- Lightweight / ultra-compact design
- Unlimited eye relief
- Wide field of view
- Integrated Weaver-style mounting system
- Ideal for shotguns, handguns, rifles muzzleloaders, airguns and crossbows

## MODEL SPECS

MODEL	POWER / OBJECTIVE	RETICLE TYPE	FINISH	INCLUDED MOUNT	CONSTRUCTION	ADJUSTABLE BRIGHTNESS	WINDAGE / ELEVATION	LENS CAPS	BATTERY
TG8020B	1x20mm	5-MOA TRI•COLOR Dot	Anodized matte black	Low	Lightweight CNC-machined aluminum	Rheostat controlled	Click windage and elevation	Rubber	3V-CR2032 Included

**ANODIZED MATTE BLACK**

TRI  
COLOR

WATER  
RESISTANT

SHOCK  
RESISTANT

FOG  
PROOF

LIMITED LIFETIME  
WARRANTY



# TRU•BRITE™

MULTI-RETICLE DUAL•COLOR OPEN DOT SIGHT

LIMITED  
LIFETIME  
WARRANTY

8

DOT•OPTICS

DUAL•COLOR

TG8385B

5-MOA DOT

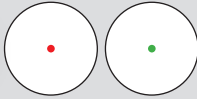

Black  
TG8385B

Black  
TG8380B



DUAL•COLOR

TG8380B

5-MOA DOT



2.5-MOA DOT

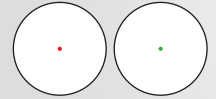

5-MOA CENTER DOT

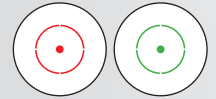

2.5-MOA CENTER DOT

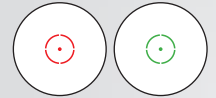

### Riser Mounts

Additional mounting options available. See page 39 for details.



### Replacement Batteries

(3V-CR2032) Battery included. See page 39 for replacement batteries.

TG988C



## PRODUCT FEATURES

- Two choices of reticle color for contrast against any target / background (red or green)
- Durable / compact design
- Unlimited eye relief
- Wide field of view
- 34mm x 24mm window for ultra-fast target acquisition
- Anti-reflective coating on target side
- Parallax free from 30 yards
- Integrated Weaver-style mounting system

## MODEL SPECS

MODEL	POWER / OBJECTIVE	RETICLETYPE	FINISH	CONSTRUCTION	ADJUSTABLE BRIGHTNESS	WINDAGE / ELEVATION	BATTERY
TG8385B	1 x 34mm	5-MOA DUAL•COLOR Dot	Anodized matte black	Lightweight CNC-machined aluminum	Rheostat controlled	Click windage and elevation	3V-CR2032 Included
TG8385BN (Boxed)							
TG8380B		DUAL•COLOR Multi-reticle					
TG8380BN (Boxed)							

ANODIZED MATTE BLACK

DUAL  
COLOR

MULTI  
RETICLE

WATER  
RESISTANT

SHOCK  
RESISTANT

LIMITED LIFETIME  
WARRANTY



# DUAL•COLOR

MULTI-RETICLE DUAL•COLOR OPEN DOT SIGHT

LIMITED  
**LIFETIME**  
WARRANTY

All the features of our original DUAL•COLOR dot sights for those who don't want a tube. A wide sight window with a thin frame makes the optic housing nearly disappear from view while your dot remains on target. The DUAL•COLOR Open Dot Sight is available with a standard dot reticle or a multi-reticle selector.

DUAL•COLOR

TG8370C

5-MOA DOT

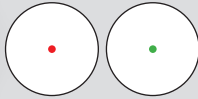

APG™  
**TG8370C**

Black  
**TG8360B**



DUAL•COLOR

TG8360B

5-MOA DOT



6-MOA CENTER DOT



CROSSHAIRS

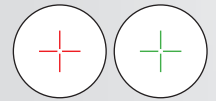

20-MOA PEEP

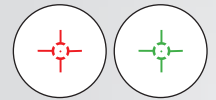

### Riser Mounts

Additional mounting options available. See page 39 for details.



### Replacement Batteries

(3V-CR2032) Battery included. See page 39 for replacement batteries.

**TG988C**



## PRODUCT FEATURES

- Two choices of reticle color for contrast against any target / background (red or green)
- Lightweight / compact design
- Unlimited eye relief
- Wide field of view
- 34mm x 24mm window for ultra-fast target acquisition
- Anti-reflective coating on target side
- Parallax free from 30 yards
- Integrated Weaver-style mounting system

## MODEL SPECS

MODEL	POWER / OBJECTIVE	RETICLE TYPE	FINISH	CONSTRUCTION	ADJUSTABLE BRIGHTNESS	WINDAGE / ELEVATION	LENS CAPS	BATTERY
TG8370B	1x 34mm	5-MOA DUAL•COLOR Dot	Anodized matte black	Lightweight CNC-machined aluminum	Rheostat controlled	Click windage and elevation	Rubber slip cover	3V-CR2032 Included
TG8370C			Realtree™ APG™					
TG8360B		DUAL•COLOR Multi-reticle	Anodized matte black					

APG™ ANODIZED MATTE BLACK

DUAL COLOR MULTI RETICLE WATER RESISTANT SHOCK RESISTANT LIMITED LIFETIME WARRANTY





# GOBBLE•STOPPER™

30MM DUAL•COLOR DOT SIGHT FOR TURKEY HUNTING

LIMITED  
**LIFETIME**  
WARRANTY

10

DOT•OPTICS

## DUAL•COLOR

### 3-MOA CENTER DOT

Illuminated circle equals  
24" at 30 yards.



*Designed to fit any railed shotgun, GOBBLE•STOPPER™ is your ideal hunting companion during turkey season. The DUAL•COLOR Center Dot reticle allows you to choose between red or green for ideal target contrast and the included sunshade prevents the glare of low-angle morning light and reflection of the objective lens. Spare battery storage inside the brightness adjustment cap ensures that you will be ready when that big tom steps out.*

30mm - Black  
**TG8030GB**



30mm - APG™  
**TG8030GA**



### Riser Mounts

Additional mounting options available. See page 39 for details.



### Replacement Batteries

(3V-CR2032) Battery included.  
See page 39 for replacement batteries.

#### TG988C



### PERFECT FOR TURKEY HUNTING

Included sunshade and specialized reticle make for a deadly combination in the turkey woods.

## PRODUCT FEATURES

- Specially designed reticle for turkey hunting
- Two choices of reticle color for contrast against any target / background (red or green)
- Detachable, extended sunshade eliminates glare from the front lens
- Spare battery storage compartment
- Flip-up lens caps / lanyard system
- Lightweight / easy to mount
- Integrated Weaver-style mounting system
- Includes 3V-CR2032 batteries (main and spare)
- Includes all the award-winning features of our TRADITIONAL Red•Dot Series (see page 12)

## MODEL SPECS

MODEL	POWER / OBJECTIVE	RETICLE TYPE	FINISH	CONSTRUCTION	ADJUSTABLE BRIGHTNESS	WINDAGE / ELEVATION	LENS CAPS	BATTERY
TG8030GB	1x 30mm	3-MOA DUAL•COLOR Center Dot	Anodized matte black	Lightweight CNC-machined aluminum	Rheostat controlled	Click windage and elevation	Flip-up	3V-CR2032 Included
TG8030GA			Realtree™ APG™					

APG™ ANODIZED MATTE BLACK

DUAL  
COLOR

WATER  
RESISTANT

SHOCK  
RESISTANT

FOG  
PROOF

LIMITED LIFETIME  
WARRANTY



# MULTI•RETICLE

MULTI-RETICLE DUAL•COLOR DOT SIGHT

LIMITED LIFETIME WARRANTY

## DUAL•COLOR

TG8030MB2

### 2.5-MOA DOT

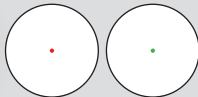

### 3-MOA CENTER DOT



### CROSSHAIRS

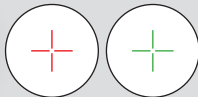

### 10-MOA PEEP

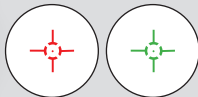

## Riser Mounts

Additional mounting options available. See page 39 for details.



## Replacement Batteries

(3V-CR2032) Battery included. See page 39 for replacement batteries.

TG988C



30mm - Black  
TG8030MB



2 x 42mm - Black  
TG8030MB2



## DUAL•COLOR

TG8030MB

### 5-MOA DOT

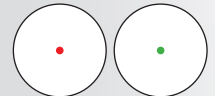

### 6-MOA CENTER DOT



### CROSSHAIRS

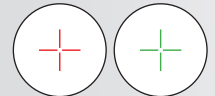

### 20-MOA PEEP

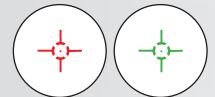

# 2x

## MAGNIFICATION

Extend the advantages of your dot optic a bit further with 2x magnification and a bright 42mm objective lens.

## PRODUCT FEATURES

- Two choices of reticle color for contrast against any target / background (red or green)
- Lightweight / compact design
- Unlimited eye relief
- Wide field of view
- Flip-up lens caps / lanyard system
- Integrated Weaver-style mounting system
- Includes all the award-winning features of our TRADITIONAL Red•Dot Series (see page 12)

## MODEL SPECS

MODEL	POWER / OBJECTIVE	RETICLE TYPE	FINISH	CONSTRUCTION	ADJUSTABLE BRIGHTNESS	WINDAGE / ELEVATION	LENS CAPS	BATTERY
TG8030MB	1 x 30mm	DUAL•COLOR Multi-reticle	Anodized matte black	Lightweight CNC-machined aluminum	Rheostat controlled	Click windage and elevation	Flip-up	3V-CR2032 Included
TG8030MB2	2 x 42mm	DUAL•COLOR Multi-reticle	Anodized matte black	Lightweight CNC-machined aluminum	Rheostat controlled	Click windage and elevation	Flip-up	3V-CR2032 Included

ANODIZED MATTE BLACK

DUAL COLOR

MULTI RETICLE

WATER RESISTANT

SHOCK RESISTANT

FOG PROOF

LIMITED LIFETIME WARRANTY



# DUAL•COLOR & TRADITIONAL

LIMITED  
**LIFETIME**  
WARRANTY

OUR ORIGINAL AWARD-WINNING DOT OPTIC SERIES

12

DOT•OPTICS

TG8030A, TG8030B, TG8030P, TG8040B

5-MOA DOT



TG8030B2

2.5-MOA DOT



2 x 42mm - Black  
**TG8030B2**



30mm - APG™  
**TG8030A**

**2x**  
MAGNIFICATION

Extend the advantages of your dot optic a bit further with 2x magnification and a bright 42mm objective lens.

## Riser Mounts

Additional mounting options available. See page 39 for details.



## PRODUCT FEATURES

- Models TG8030DB and TG8030DBR include DUAL•COLOR reticle illumination (red or green)
- Unlimited eye relief
- Wide field of view
- Flip-up lens caps / lanyard system (included on all models except TG8030P)
- Lightweight / easy to mount
- Integrated Weaver-style mounting system
- Ideal for shotguns, handguns, rifles, muzzleloaders, airguns and crossbows
- Model TG8030DBR Includes an integral saddle mount for Remington® 12 ga. shotguns (Models 870 / 1100 / 11-87 only)



**DUAL•COLOR**

TG8030DBR, TG8030DB

5-MOA DOT

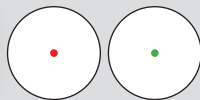

**Replacement Batteries**

(3V-CR2032) Battery included.  
See page 39 for replacement batteries.

**TG988C**



30mm - Black  
**TG8030DBR**



**REMINGTON®  
SADDLE MOUNT**

Integrated saddle mount fits Remington® 12 ga. shotgun receivers. (Models 870 / 1100 / 11-87 only)  
Integral mount and optic housing are machined from a single piece of aluminum for maximum accuracy and mounting consistency.

**MODEL SPECS**

MODEL	POWER / OBJECTIVE	RETICLE TYPE	FINISH	CONSTRUCTION	ADJUSTABLE BRIGHTNESS	WINDAGE / ELEVATION	LENS CAPS	BATTERY
TG8030A	1 x 30mm	5-MOA Red Dot	Realtree™ APG™	Lightweight CNC-machined aluminum	Rheostat controlled	Click windage and elevation	Flip-up	3V-CR2032 Included
TG8030B			Standard					
TG8030P		5-MOA DUAL•COLOR Dot	Anodized matte black					
TG8030DB		5-MOA DUAL•COLOR Dot						
TG8030DBR		5-MOA DUAL•COLOR Dot						
TG8040B	1 x 40mm	5-MOA Red Dot				Flip-up		
TG8030B2	2 x 42mm	2.5-MOA Red Dot						

APG™ ANODIZED MATTE BLACK

- DUAL COLOR
- WATER RESISTANT
- SHOCK RESISTANT
- FOG PROOF
- LIMITED LIFETIME WARRANTY



# SCOPES

Bright telescopic sights for rifles, muzzleloaders, and shotguns.



# TRU•BRITE™ 30 HUNTER

LIMITED LIFETIME WARRANTY

30MM COMPACT SCOPE

TRU•BRITE™ 30 HUNTER offers the perfect combination of clarity, precision, and speed for shotguns and rifles. Featuring a 30mm tube and variable 1-4 x 24mm magnification, the HUNTER model boasts an extremely wide field of view – ideal for turkey, deer, hog, and varmint hunting or other medium-range precision shooting. With true 1x magnification, hunters can now utilize an extremely fast sight picture and even take the shot with both eyes open.

CIRCLE DUPLEX

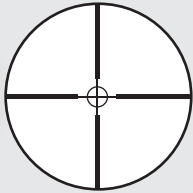

1-4 x 24mm - Black  
TG8514BC



WEAVER-STYLE RINGS INCLUDED

EXTREMELY WIDE FIELD OF VIEW

### Riser Mounts

Additional mounting options available. See page 39 for details.



## PRODUCT FEATURES

- 1-4x magnification for fast target acquisition
- 30mm tube for increased brightness and click adjustments
- 3.75" eye relief
- Fully-coated lenses provide maximum brightness, clarity and contrast
- Durable leaf-spring click adjustments for windage and elevation
- Waterproof / fog-proof / nitrogen gas-filled
- Extremely wide field of view
- 1/2-MOA Windage / Elevation adjustments
- Weaver-style rings included
- Bright 24mm objective lens

## MODEL SPECS

MODEL	POWER / OBJECTIVE	RETICLE TYPE	FINISH	CONSTRUCTION	WINDAGE / ELEVATION	LENS CAPS	RINGS
TG8514BC	1-4 x 24mm	Circle Duplex	Anodized matte black	One-piece 30mm aluminum tube	Durable leaf spring – fingertip adjustments	Flip-up	Weaver-style

ANODIZED MATTE BLACK

WATER RESISTANT

SHOCK RESISTANT

NITROGEN GAS-FILLED

FOG PROOF

RINGS INCLUDED

LIMITED LIFETIME WARRANTY



# TRU•BRITE™ XTREME

LIMITED  
LIFETIME  
WARRANTY

ILLUMINATED-RETICLE RIFLE SCOPE SERIES

16

SCOPES

## DUAL•COLOR

### ILLUMINATED BDC (Bullet Drop Compensating)

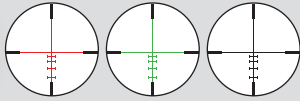

TRU•BRITE™ Xtreme Series scopes are built with high-quality optics that offer shooters a bright, clear, high contrast field of view in any situation. The DUAL•COLOR illuminated reticle helps ensure exact shot placement in low-light conditions. The large diameter fingertip windage and elevation knobs allow for easy adjustments when sighting in. With all these features in hand, you can be extremely confident when the time comes to take the shot.

4-16 x 50mm - Black  
**TG8514BxB**



## PRODUCT FEATURES

- Ultra-high contrast, high resolution mechanical and optical design
- DUAL•COLOR illuminated reticle allows choice of red or green for faster target acquisition in low-light conditions
- Reticle can be used in black without illumination
- BDC (Bullet-Drop Compensating) can be easily calibrated to most centerfire cartridges and accommodate targets up to 600 yards away
- Rubber-coated, speed-focus eye piece
- Specially formulated multi-coating provide maximum brightness, clarity and contrast even in the poorest of light conditions
- Special internal anti-reflective coating on metal parts
- Zoom index at 9 o'clock for more ergonomic use
- Low-profile, large diameter fingertip adjustments for W/E under screw cap

### Replacement Batteries

(3V-CR2032) Battery included.  
See page 39 for replacement batteries.

**TG988C**



## MODEL SPECS

MODEL	POWER / OBJECTIVE	ACTION LENGTH	RETICLE TYPE	FINISH	CONSTRUCTION	ADJUSTABLE BRIGHTNESS	WINDAGE / ELEVATION	LENS CAPS	RINGS	BATTERY
TG8539LXB	3-9 x 44mm	6.46"	BDC (Bullet-Drop Compensating)	Anodized matte black	One-piece aircraft quality aluminum tube	Rheostat controlled	Durable leaf spring - fingertip adjustments	Flip-up	-	3V-CR2032 Included
TG8539BxB		4.25"								
TG8531BxB	3-12 x 44mm	5.00"								
TG8541BxB	4-16 x 50mm	5.12"								

ANODIZED MATTE BLACK

DUAL  
COLOR

WATER  
RESISTANT

SHOCK  
RESISTANT

NITROGEN  
GAS-FILLED

FOG  
PROOF

LIMITED LIFETIME  
WARRANTY



# TRU•BRITE™ XTREME MUZZLELOADER

LIMITED LIFETIME WARRANTY

ILLUMINATED-RETICLE MUZZLELOADER SCOPE

DUAL•COLOR

ILLUMINATED MUZZLELOADER BDC (Bullet Drop Compensating)

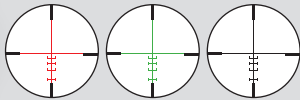

Based on the effectiveness and popularity of the TRU•BRITE™ rifle scope series, we created a model dedicated to muzzleloader hunters. The Muzzleloader BDC reticle helps shooters more accurately predict bullet drop for trajectories of slower projectiles, and can be easily calibrated to many bullet / powder combinations to provide aiming points out to 300 yards.



3-12 x 44mm - Black  
TG8531BLM

### Riser Mounts

Additional mounting options available. See page 39 for details.



## PRODUCT FEATURES

- BDC Muzzleloader reticle can be easily calibrated to many bullet / powder combinations and provides aiming points out to 300 yards
- DUAL•COLOR illuminated reticle allows choice of red or green for faster target acquisition in low-light conditions
- Reticle can be used in black without illumination
- Durable, textured, non-reflective matte finish
- Includes all the award-winning features of our TRU•BRITE™ XTREME Scope Series (see previous page)

## MODEL SPECS

MODEL	POWER / OBJECTIVE	ACTION LENGTH	RETICLE TYPE	FINISH	CONSTRUCTION	ADJUSTABLE BRIGHTNESS	WINDAGE / ELEVATION	LENS CAPS	RINGS	BATTERY
TG8531BLM	3-12 x 44mm	4.80"	BDC (Bullet-Drop Compensating)	Anodized matte black	One-piece aircraft quality aluminum tube	Rheostat controlled	Durable leaf spring – fingertip adjustments	Flip-up	–	3V-CR2032 Included

ANODIZED MATTE BLACK

DUAL COLOR

WATER RESISTANT

SHOCK RESISTANT

NITROGEN GAS-FILLED

FOG PROOF

LIMITED LIFETIME WARRANTY





# HUNT•TEC™

ILLUMINATED-RETICLE 4 x 32MM COMPACT RIFLE SCOPE

18

SCOPES

The 4x fixed magnification scope is a proven and popular choice for riflemen all over the world. HUNT•TEC™ builds on this tradition with a compact design, multi-coated lenses, and a glass etched reticle with available red and green illumination.

## DUAL•COLOR

TG8504AL

FLOATING ILLUMINATED  
DUPLEX RETICLE

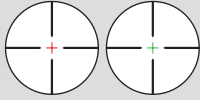

4 x 32mm - Black  
**TG8504AL**

TG8504A

DUPLEX RETICLE



4 x 32mm - Black  
**TG8504A**

### Replacement Batteries

(3V-CR2032) Battery included with illuminated model.

See page 39 for replacement batteries.

**TG988C**



## PRODUCT FEATURES

- Model TG8504AL includes a DUAL•COLOR illuminated reticle for increased contrast in low-light conditions
- Water-resistant / fog-proof / nitrogen gas-filled
- Generous 4" eye relief
- Fully-coated lenses provide maximum brightness, clarity and contrast
- Wide field of view
- Durable leaf-spring click adjustments for windage and elevation
- 1/2-MOA Windage / Elevation adjustments
- Weaver-style rings included
- Bright 32mm objective lens

## MODEL SPECS

MODEL	POWER / OBJECTIVE	RETICLE TYPE	FINISH	CONSTRUCTION	ADJUSTABLE BRIGHTNESS	WINDAGE / ELEVATION	LENS CAPS	RINGS	BATTERY
TG8504AL	4 x 32mm	Illuminated Duplex	Anodized matte black	One-piece aircraft quality aluminum tube	Rheostat controlled	Durable leaf spring - fingertip adjustments	Elastic	Weaver-style	3V-CR2032 Included
TG8504A		Duplex			-				-

**ANODIZED MATTE BLACK**

DUAL  
COLOR

WATER  
RESISTANT

SHOCK  
RESISTANT

NITROGEN  
GAS-FILLED

FOG  
PROOF

RINGS  
INCLUDED



# 4 X 32MM COMPACT

SCOPE SERIES FOR RIMFIRE AND SHOTGUNS

LIMITED  
**LIFETIME**  
WARRANTY

TG8504BR

DUPLEX



4 x 32mm - Black  
**TG8504BR**

TG8504BD, TG8504CD

DIAMOND



4 x 32mm - APG™  
**TG8504CD**

### Riser Mounts

Additional mounting options available. See page 39 for details.



## PRODUCT FEATURES

- Diamond reticle is specially designed for shotgun hunting and is perfect for turkey and deer
- Fully-coated lenses provide maximum brightness, clarity and contrast
- Rubber eye guard
- Durable, scratch-resistant, non-reflective matte finish
- Model TG8504BR includes 3/8" rings for rimfire and air rifles
- Models TG8504BD/CD include Weaver-style rings

## MODEL SPECS

MODEL	POWER / OBJECTIVE	ACTION LENGTH	RETICLE TYPE	FINISH	CONSTRUCTION	WINDAGE / ELEVATION	LENS CAPS	RINGS	BATTERY
TG8504BR	4 x 32mm	4.80"	Duplex	Anodized matte black	One-piece aircraft quality aluminum tube	Durable leaf spring - fingertip adjustments	Elastic	3/8"	-
TG8504BD			Diamond	Realtree™ APG™				Weaver-style	
TG8504CD									

APG™ ANODIZED MATTE BLACK

WATER  
RESISTANT

SHOCK  
RESISTANT

NITROGEN  
GAS-FILLED

FOG  
PROOF

RINGS  
INCLUDED

LIMITED LIFETIME  
WARRANTY



# TRUSHOT™

RIFLE SCOPE SERIES

20

SCOPES

DUPLEX

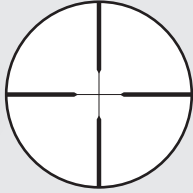

4 x 32mm - Black  
**TG850432B**



3-9 x 40mm - Black  
**TG853940B**

## Scope Rings

Available with Weaver-style or 3/8" rings. See chart for details.



## PRODUCT FEATURES

- Duplex reticle
- Generous eye relief
- Fully-coated lenses provide maximum brightness, clarity and contrast
- Rubber-coated, speed-focus eye piece
- Durable, scratch-resistant, non-reflective matte finish
- Model TG850432B does not include mounting rings
- Waterproof / fog-proof / nitrogen gas-filled



2-7 x 32mm - Black  
**TG852732B**



3-9 x 32mm - Black  
**TG853932B**



## MODEL SPECS

MODEL	POWER / OBJECTIVE	RETICLE TYPE	FINISH	CONSTRUCTION	WINDAGE / ELEVATION	LENS CAPS	RINGS	BATTERY
<b>TG853940B</b>	3-9 x 40mm	Duplex	Anodized matte black	One-piece aircraft quality aluminum tube	Durable leaf spring – fingertip adjustments	Elastic	Weaver-style	–
<b>TG853932B</b>	3-9 x 32mm						3/8"	
<b>TG852732B</b>	2-7 x 32mm						Weaver-style	
<b>TG850432B</b>	4 x 32mm						–	

**ANODIZED MATTE BLACK**

**WATER  
RESISTANT**

**SHOCK  
RESISTANT**

**NITROGEN  
GAS-FILLED**

**FOG  
PROOF**

**RINGS  
INCLUDED**



# FIBER-OPTIC SIGHTS

Redirecting the light of your environment to create a vivid and fast sight picture.



# TURKEY HUNTING

FRONT AND REAR SHOTGUN SIGHT SETS

## NEW F.A.S.T.™ UNIVERSAL SHOTGUN SIGHTS

FOCUS ASSISTING SIGHT TECHNOLOGY

- Ramp-style rear sight for fast and easy sight alignment
- Front fiber diameter is .060"
- Adjustable windage and elevation
- Compatible with most 12 and 20 ga. shotgun barrels with ventilated ribs
- Great for: Turkey hunting, still target shooting, slugs, and buckshot
- Patent pending



MODEL	DESCRIPTION
NEW TG940	Front Sight: Red fiber-optic; Rear Sight: Green Battue-style ramp

UNIVERSAL FIT

## GOBBLE•DOT™ UNIVERSAL / DUAL•COLOR

3-DOT SIGHTS FOR VENTILATED RIB SHOTGUNS

- Our original turkey sight - available in red or DUAL•COLOR
- Fits all ventilated rib shotguns regardless of width or tapering
- Model TG94D front diameter is .120"; rear diameter is .040"
- Model TG94 front diameter is .060"; rear diameter is .035"
- Endorsed by the National Wild Turkey Federation

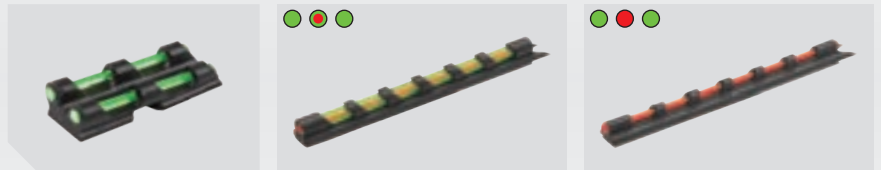

MODEL	DESCRIPTION
TG94	Notched rear sight / Red front sight
TG94D	Notched rear sight / DUAL•COLOR front sight

UNIVERSAL FIT

DUAL COLOR



## TRU•BEAD™ TURKEY UNIVERSAL SERIES

3-DOT SIGHTS FOR VENTILATED RIB SHOTGUNS

- The industry's most popular fiber-optic turkey sight series - now in DUAL•COLOR
- Universal mounting system for ventilated rib shotguns with ribs up to 3/8"
- Front sight includes different sized "clips" to eliminate twisting
- Full windage and elevation adjustment
- CNC-machined
- Hardware included
- Includes two interchangeable rear sights
- Model TG950XD, Front diameter is .120"; rear diameter is .035"
- Model TG950X, Front diameter is .060"; rear diameter is .035"
- Endorsed by the National Wild Turkey Federation

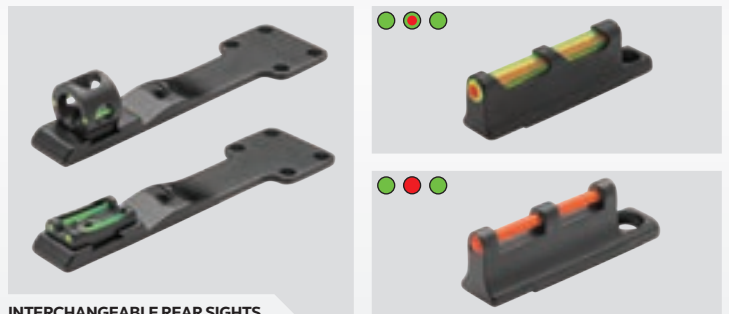

INTERCHANGEABLE REAR SIGHTS

MODEL	DESCRIPTION
TG950XD	Rear ghost ring and notched rear sight / DUAL•COLOR threaded front sight
TG950X	Rear ghost ring and notched rear sight / standard threaded front sight

UNIVERSAL FIT

DUAL COLOR

INTERCHANGEABLE REAR SIGHTS





# TURKEY HUNTING

FRONT AND REAR SHOTGUN SIGHT SETS

24

FIBER-OPTIC SIGHTS

## TRU•POINT™ XTREME UNIVERSAL TURKEY / DEER

3-DOT SIGHTS WITH ELEVATION RAMP FOR VENTILATED RIB SHOTGUNS

- Rifle-style elevated sights for the serious turkey and deer hunter
- Universal fit for ventilated rib shotguns
- Includes two interchangeable rear sights
- All-metal construction
- Full windage and elevation adjustment
- Front diameter is .060"; rear diameter is .029"
- Endorsed by the National Wild Turkey Federation



INTERCHANGEABLE REAR SIGHTS

MODEL

TG960

UNIVERSAL FIT

ALL-METAL CONSTRUCTION

INTERCHANGEABLE REAR SIGHTS



## PRO•SERIES™ MAGNUM GOBBLE•DOT™

3-DOT SIGHTS WITH ELEVATION RAMP FOR VENTILATED RIB SHOTGUNS

- Our ultimate turkey sight
- All-steel construction
- Securely mounts to your rib without tape or magnets
- Front diameter is .029"; rear diameter is .035"
- Endorsed by the National Wild Turkey Federation

MODEL	COMPATIBLE GUN MODELS
TG944A	Fits most Charles Daly and Remington models
TG944B	Fits most Mossberg, Weatherby and Winchester (excluding SX3) models
TG944C	Fits most Beretta Field Grade, Franchi, Browning Gold / A-5 and Winchester SX3 models
TG944D	Fits most Benelli Super Black Eagle / M1 / Nova, Browning BPS / Ruger Red Label, Stoeger Model 2000 and Savage models



Please check gun chart on pages 42-43 for specific gun models.

ALL-METAL CONSTRUCTION



## MAGNUM GOBBLE•DOT™ XTREME SERIES

3-DOT SIGHTS FOR VENTILATED RIB SHOTGUNS

- Each model easily snaps over rib without need for screws
- Front diameter is .060"; rear diameter is .035"
- Endorsed by the National Wild Turkey Federation

STANDARD MODEL	COMPATIBLE GUN MODELS
TG941XA	1/4" rib width fits most Remington, Browning Gold (camo) and Charles Daly
TG941XB	3/8" rib width fits most Mossberg, Weatherby, Winchester (excluding SX3) and popular 10 ga. models
TG941XC	6mm rib width fits most Beretta Field Grade, Benelli 20 ga., Browning Gold / A-5, Franchi and Winchester SX3 models
TG941XD	5/16" rib width fits most Benelli, Browning BPS, Ithaca, Ruger Red Label, Savage and 8mm ribs



MAGNETIC MODEL

COMPATIBLE GUN MODELS

TG942XA

1/4" rib width, see left for models

TG942XB

3/8" rib width, see left for models

Please check gun chart on pages 42-43 for specific gun models.

TRUGLO® HUNTING / OPTICS 2017





# WING & CLAY

UNIVERSAL SHOTGUN FRONT SIGHTS

## GLO•DOT™ UNIVERSAL PRO•SERIES

FRONT SIGHT FOR VENTILATED RIB SHOTGUNS

- Helps eliminate problems with eye dominance
- Promotes shooting with both eyes open
- Promotes proper gun mounting / shouldering
- Extremely low-profile
- Easy installation
- Universal – fits any rib width
- Quick target acquisition
- Single color fiber diameter is .078"
- DUAL•COLOR fiber diameter is .120"

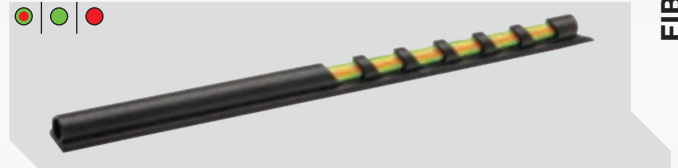

MODEL	COLOR
TG104G	Green
TG104R	Red
TG104D	DUAL•COLOR

UNIVERSAL FIT

DUAL COLOR



## GLO•DOT™ UNIVERSAL

FRONT SIGHT FOR VENTILATED RIB SHOTGUNS

- Our original wing and clay sight
- Fits all ventilated rib shotguns regardless of width or tapering
- Extremely low profile
- Models TG90, TG91, Fiber diameter is .060"
- Model TG90D, Fiber diameter is .120"
- Endorsed by Ducks Unlimited

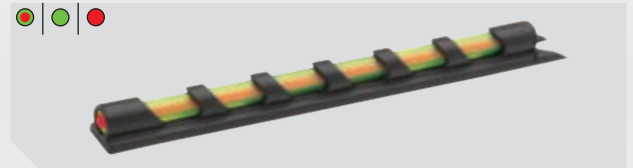

MODEL	COLOR
TG90	Red
TG91	Green
TG90D	DUAL•COLOR

UNIVERSAL FIT

DUAL COLOR



## WING•STOPPER™ / STRUT•STOPPER™ UNIVERSAL

FRONT SIGHT FOR VENT RIB SHOTGUNS

- Front dot can only be seen when shooter is perfectly aligned
- Universal model fits all ventilated rib shotguns regardless of width or tapering
- Aids correct eye dominance
- Fiber diameter is .060"
- WING•STOPPER™ endorsed by Ducks Unlimited
- STRUT•STOPPER™ endorsed by the National Wild Turkey Federation

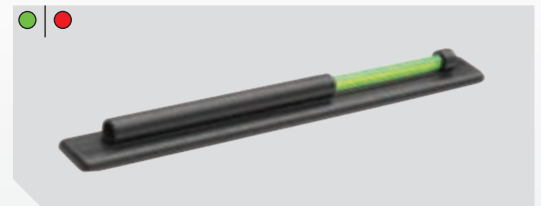

STRUT•STOPPER™

WING•STOPPER™

STANDARD MODEL	COLOR	STANDARD MODEL	COLOR	UNIVERSAL MODEL	COLOR
TG945R	Red	TG103R	Red	TG103UR	Red
TG945G	Green	TG103G	Green	TG103UG	Green

Please check gun chart on pages 42-43 for specific gun models.

UNIVERSAL FIT







# WING & CLAY

SHOTGUN FRONT SIGHTS

26

FIBER-OPTIC SIGHTS

## GLO•DOT™ XTREME UNIVERSAL

MAGNETIC FRONT SIGHT FOR VENTILATED RIB SHOTGUNS

- Our original wing and clay sight
- Fits all ventilated rib shotguns regardless of width or tapering
- Extremely low profile
- Fiber diameter is .060"
- Endorsed by Ducks Unlimited



**MODEL**  
TG90X

UNIVERSAL FIT

INTERCHANGEABLE FIBER COLORS



## MAGNUM GLO•DOT™ XTREME SERIES

FRONT SIGHT FOR VENTILATED RIB SHOTGUNS

- Each model easily snaps over rib without need for screws
- Fiber diameter is .060"
- Endorsed by Ducks Unlimited

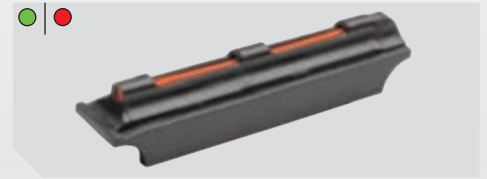

STANDARD MODEL	MAGNETIC MODEL	COLOR	RIB WIDTH	COMPATIBLE GUN MODELS
TG901XA	TG902XA	Red	1/4"	Fits most Remington, Browning Gold (camo) and Charles Daly
TG901XB	TG902XB	Green		
TG911XA	TG912XA	Red	3/8"	Fits most Mossberg, Weatherby, Winchester (excluding SX3) and popular 10 ga. models
TG911XB	TG912XB	Green		
TG905XA	—	Red	6mm	Fits most Beretta Field Grade, Benelli 20 ga., Browning Gold / A-5, Franchi and Winchester SX3 models
TG905XB	—	Green		
TG904XA	—	Red	5/16"	Fits most Benelli Browning BPS, Ithaca, Ruger Red Label, Savage and 8mm ribs
TG904XB	—	Green		

Please check gun chart on pages 42-43 for specific gun models.



## TRU•POINT™ WING AND CLAY

FRONT SIGHT FOR VENTILATED RIB SHOTGUNS

- Patented Slide-Lok™ Mounting System
- Mounts to the rib without tape, screws or magnets
- Special nylon liner protects rib and locks metal sight in place
- CNC-machined
- Fiber diameter is .060"
- Endorsed by Ducks Unlimited

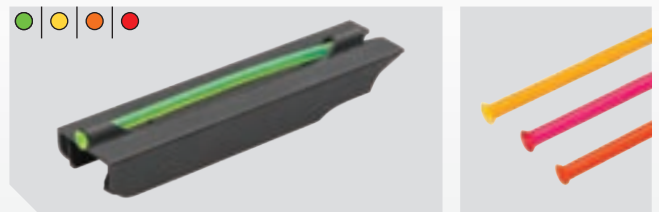

MODEL	COMPATIBLE GUN MODELS
TG957A	Remington (excluding 2007 or later 870 Express)
TG957C	Beretta Field Grade
TG957E	Ruger Red Label

Please check gun chart on pages 42-43 for specific gun models.

INTERCHANGEABLE FIBER COLORS



TRUGLO® HUNTING / OPTICS 2017



# WING & CLAY

FRONT AND REAR SHOTGUN SIGHT SETS

## TRU•BEAD™ UNIVERSAL DUAL•COLOR

BEAD REPLACEMENT SIGHT FOR VENTILATED RIB SHOTGUNS

- Fits any rib width
- Replaces front bead
- Front sight includes different sized "clips" to eliminate twisting
- Extremely low-profile
- Fiber diameter is .120"
- CNC-machined
- Hardware included
- Endorsed by Ducks Unlimited

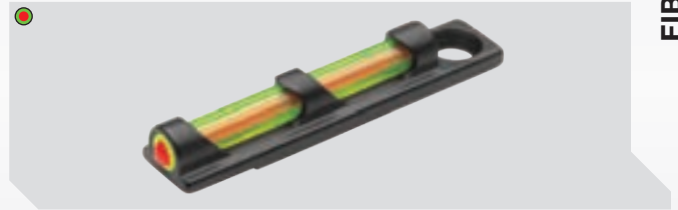

MODEL	COLOR
TG949D	DUAL•COLOR

UNIVERSAL FIT

DUAL COLOR



## TRU•BEAD™ UNIVERSAL

BEAD REPLACEMENT SIGHT FOR VENTILATED RIB SHOTGUNS

- Fits any rib width
- Replaces front bead
- Includes interchangeable fibers
- Front sight includes different sized "clips" to eliminate twisting
- Extremely low profile
- Available in two different fiber diameters
- CNC-machined
- Hardware included
- Endorsed by Ducks Unlimited



MODEL	FIBER DIAMETER
TG949A	.060" (Field model)
TG949B	.078" (Target model)

UNIVERSAL FIT

INTERCHANGEABLE FIBER COLORS



## GLO•DOT™ II UNIVERSAL

FRONT SIGHT FOR PLAIN BARREL SHOTGUNS

- Designed for plain barrel shotguns
- Easy installation
- Extremely low profile
- Ultra-tough construction
- Fiber diameter is .078"
- Endorsed by Ducks Unlimited

MODEL	GAUGE	COLOR
TG92A	12-20	Red
TG93A		Green
TG92B	.410	Red
TG93B		Green



UNIVERSAL FIT





# WING & CLAY

SHOTGUN BEAD REPLACEMENT SIGHTS

28

FIBER-OPTIC SIGHTS

## FAT•BEAD™ & FAT•BEAD™ UNIVERSAL

BEAD REPLACEMENT SIGHT FOR VENTILATED RIB SHOTGUNS

- Our largest diameter bead replacement
- CNC-machined
- Single color fiber diameter is .0100"; DUAL•COLOR fiber diameter is .120"
- Fiber length is 0.5"



MODEL	COLOR	THREAD SIZE
TG948AD†	DUAL•COLOR	6-48
TG948BD		3-56
TG948CD		2.6mm
TG948DD		5-40
TG948ED		3mm
TG948AR†	Red	6-48
TG948BR		3-56
TG948CR		2.6mm
TG948DR		5-40
TG948ER		3mm
TG948AG†	Green	6-48
TG948BG		3-56
TG948CG		2.6mm
TG948DG		5-40
TG948EG		3mm
TG948UD*	DUAL•COLOR	Universal
TG948UR*	Red	
TG948UG*	Green	

Please check gun chart on pages 42-43 for specific gun models.

\* Please note: TG948UD / TG948UR / TG948UG includes thread adapters for 6-48 / 3-56 / 2.6mm / 5-40 / 3mm threads.

† On some REMINGTON® Shotguns, sight will install properly, but end of sight may extend slightly beyond end of ventilated rib.

UNIVERSAL FIT

DUAL COLOR



## LONG•BEAD™ & LONG•BEAD™ UNIVERSAL

BEAD REPLACEMENT SIGHT FOR VENTILATED RIB SHOTGUNS

- CNC-machined
- Fiber diameter is .078"
- Fiber length is 0.5"
- Universal model includes different size mounting screws



UNIVERSAL MODEL	COLOR
TG947UR*	Red
TG947UG*	Green

MODEL	COLOR	THREAD SIZE
TG947ARM†	Red	6-48
TG947BRM		3-56
TG947CRM		2.6mm
TG947DRM		5-40
TG947ERM		3mm
TG947AGM†	Green	6-48
TG947BGM		3-56
TG947CGM		2.6mm
TG947DGM		5-40
TG947EGM		3mm

Please check gun chart on pages 42-43 for specific gun models.

\* Please note: TG947UR / TG947UG includes thread adapters for 6-48 / 3-56 / 2.6mm / 5-40 / 3mm threads.

† On some REMINGTON® Shotguns, sight will install properly, but end of sight may extend slightly beyond end of ventilated rib.

UNIVERSAL FIT

## STARBRITE DELUXE™

BEAD REPLACEMENT SIGHT FOR VENTILATED RIB SHOTGUNS

- Our smallest diameter bead replacement
- CNC-machined
- Fiber diameter is .060"
- Fiber length is 0.25"
- Endorsed by Ducks Unlimited



MODEL	COLOR	THREAD SIZE
TG954AR	Red	6-48
TG954BR		3-56
TG954CR		5-40
TG954DR		2.6mm
TG954ER		3mm
TG954FR		3-56 short thread (Ruger)
TG954AG	Green	6-48
TG954BG		3-56
TG954CG		5-40
TG954DG		2.6mm
TG954EG		3mm
TG954FG		3-56 short thread (Ruger)

Please check gun chart on pages 42-43 for specific gun models.

TRUGLO® HUNTING / OPTICS 2017





# SLUG / RIFLE / MUZZLELOADER

FRONT AND REAR SIGHT SETS

## PRO-SERIES™ SLUG GUN SIGHTS

3-DOT SIGHTS WITH ELEVATION RAMP FOR VENTILATED RIB SHOTGUNS

- Our ultimate slug gun sight
- All steel construction
- Securely mounts to your rib without tape or magnets
- Full windage and elevation adjustment
- Front diameter is .029"
- Rear diameter is .035"

MODEL	COMPATIBLE GUN MODELS
TG962A	Fits most Charles Daly and Remington models
TG962B	Fits most Mossberg, Weatherby and Winchester (excluding SX3) models
TG962C	Fits most Beretta Field Grade, Franchi, Browning Gold / A-5 and Winchester SX3 models
TG962D	Fits most Benelli Super Black Eagle / M1 / Nova, Browning BPS / Ruger Red Label, Stoeger Model 2000 and Savage models

Please check gun chart on pages 42-43 for specific gun models.



ALL-STEEL  
CONSTRUCTION

## SLUG GUN SERIES

3-DOT REPLACEMENT SIGHTS FOR FACTORY DOVETAILS

- Dovetail mount built to manufacturers' specifications
- Full windage and elevation adjustment
- CNC-machined metal and composite construction
- Front fiber diameter is .035"
- Rear fiber diameter is .035"

MODEL	COMPATIBLE GUN MODELS
TG961M	Mossberg
TG961R	Remington
TG961W	Winchester





# SLUG / RIFLE / MUZZLELOADER

FRONT AND REAR SIGHT SETS

30

FIBER-OPTIC SIGHTS

## TFX™ PRO REMINGTON® SIGHTS

TRITIUM + FIBER-OPTIC XTREME SIGHT SET FOR REMINGTON MODELS

### Quick and Accurate

U-Notch rear sight design.

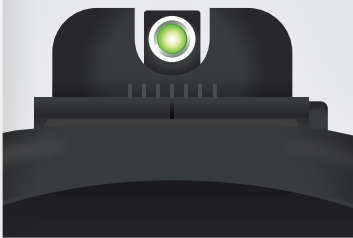

- Front sight utilizes TFO® technology for 24/7 Brightness
- Uses the brightest Swiss tritium available
- Glow-in-the-dark
- No batteries required
- Concealed fiber cannot be seen by target
- Fits Remington® Shotguns with dovetail sight mounts



MODEL	REAR SIGHT	FRONT SIGHT	FIBER-OPTICS	TRITIUM	NOTCH STYLE
TG13RM1PB	U-Notch	TFX PRO, White Ring	Yes	Yes	PRO

ASSEMBLED IN THE USA

TFX™ SEALED CAPSULE

FOCUS LOCK

U-NOTCH REAR SIGHT

ALL-STEEL CONSTRUCTION

## FIBER-OPTIC REMINGTON® SIGHTS

FIBER-OPTIC SIGHT SET FOR REMINGTON MODELS

- Fits most newer model Remingtons, including 700 Series muzzleloaders
- Full windage and elevation adjustment
- Includes front and rear fiber holders
- CNC-machined steel construction
- Front diameter is .050"
- Rear diameter is .035"



MODEL

TG110W

Excludes newer 700 / 7500 / 760 models with one-piece front sight design. Excludes Takedown® model.

ALL-STEEL CONSTRUCTION

TRUGLO® HUNTING / OPTICS 2017



# SLUG / RIFLE / MUZZLELOADER

FRONT AND REAR SIGHT SETS

## LEVER ACTION RIFLE

3-DOT REPLACEMENT SIGHTS FOR POPULAR LEVER ACTION MODELS

- Replaces existing factory sights
- CNC-machined
- Full windage and elevation adjustment
- Front diameter is .060"
- Rear diameter is .035"

MODEL	HEIGHT (FRONT)	COMPATIBLE GUN MODELS
TG109	.343"	Marlin 336 Rifle Set
TG112	.450"	Winchester 94 / Henry Golden Boy .22LR / Marlin Guide Rifles / Henry Big Boy .44MAG
TG114	.500"	Henry Golden Boy .22MAG / .17HMR / Henry Big Boy .357 / 45 Colt

Listed heights are measured from the bottom of the dovetail.  
For rifle length barrels – Not for carbine barrels.

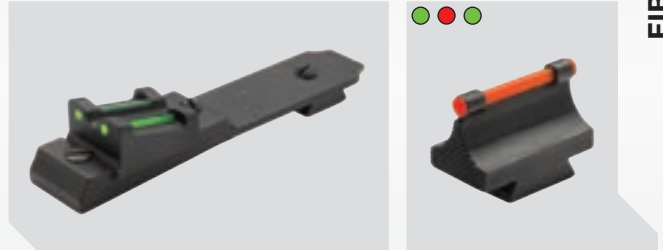

ALL-METAL CONSTRUCTION

## 3/8" METAL DOVETAIL FRONT SIGHTS

REPLACEMENT FIBER-OPTIC FRONT SIGHTS FOR A VARIETY OF FIREARMS

- Fits any standard 3/8" dovetail
- CNC-machined steel construction
- Fiber diameter is .060"

MODEL	COLOR	HEIGHT
TG95343RR	Red	.343"
TG95450RR		.450"
TG95500RR		.500"
TG95530RR		.530"
TG95343RG	Green	.343"
TG95450RG		.450"
TG95500RG		.500"
TG95530RG		.530"

Listed heights are measured from the bottom of the dovetail.

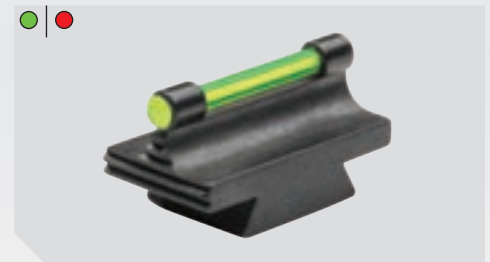

ALL-STEEL CONSTRUCTION

## MUZZLE•BRITE™ XTREME UNIVERSAL SERIES

REPLACEMENT FIBER-OPTIC SIGHT SETS FOR MUZZLELOADERS

- Universal mounting system for in-line muzzleloaders
- Model TG131ML includes Tritium + Fiber-Optic Technology for 24/7 brightness
- CNC-machined
- Full windage and elevation adjustment
- Front diameter is .040"
- Rear diameter is .029"
- Endorsed by the Rocky Mountain Elk Foundation

### TFO®

Tritium + Fiber-Optic technology for a bright sight picture in all lighting conditions.



INTERCHANGEABLE REAR SIGHTS

MODEL	DESCRIPTION
TG131ML	TFO® Notched rear sight / TFO® Standard front sight

MODEL	DESCRIPTION
TG958X	Interchangeable rear ghost ring and notched rear sight / Standard front sight

TFO® TRITIUM / FIBER OPTIC

UNIVERSAL FIT

ALL-METAL CONSTRUCTION

CNC MACHINED





# RIMFIRE / AIRGUN

FRONT AND REAR SIGHTS

32

FIBER-OPTIC SIGHTS

## RIMFIRE PISTOL FIBER-OPTIC FRONT SIGHT

REPLACEMENT SIGHT FOR POPULAR RIMFIRE TARGET PISTOLS

- Replaces existing front sight
- Extremely bright in low-light conditions
- Front diameter is .060"
- CNC-machined
- Height is approximately .445"
- Easy installation

MODEL	COLOR	DESCRIPTION
TG965R	Red	Fits most Ruger® MKII™, MKIII™, 22 / 45™ and Browning® Buck Mark™ rimfire pistols
TG965G	Green	

Please note: Not suited for use with Ruger® tapered barrel designs or 22/45 LITE models. Does not fit Buck Mark™ contour models.



ALL-METAL  
CONSTRUCTION

CNC  
MACHINED

## RIMFIRE RIFLE FIBER-OPTIC FRONT SIGHT

REPLACEMENT SIGHT FOR POPULAR RIMFIRE RIFLES

- Replaces existing front sights
- Extremely bright in low-light conditions
- CNC-machined
- Front diameter is .060"
- Height is approximately .400"
- Easy installation

MODEL	COLOR	DESCRIPTION
TG975R	Red	Fits most Marlin® rimfire rifles
TG975G	Green	

Please note: Not suited for use with Marlin® hooded front sight models.



ALL-METAL  
CONSTRUCTION

CNC  
MACHINED

## RIMFIRE RIFLE FIBER-OPTIC SIGHT SET

REPLACEMENT SIGHT FOR POPULAR RIMFIRE RIFLES

- Replaces existing factory sight
- CNC-machined
- Full windage and elevation adjustment
- Front diameter is .060"
- Rear diameter is .035"

MODEL	HEIGHT (FRONT)	COMPATIBLE GUN MODELS
TG11W	.500"	Ruger® 10/22 rifle

Please note: Not compatible with TAKEDOWN™ Models.



ALL-METAL  
CONSTRUCTION

CNC  
MACHINED

## AIRGUN GLOBE SIGHTS

FIBER-OPTIC FRONT SIGHT FOR COMPETITION AIRGUNS

- Revolutionary design for airguns
- Extra-long, wrapped fiber-optics in a protective housing
- Ultra-bright aiming point
- Easy installation
- "Match" models thread into existing 18mm and 22mm front sight housings
- "Match" models include locking ring for precise canting alignment
- Model TG925G fits most popular airgun front dovetails and includes optional sunshade

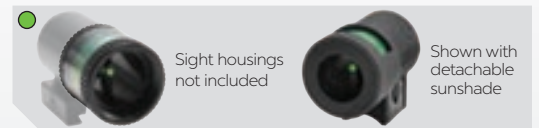

MODEL	COLOR	FIBER DIAMETER	DESCRIPTION
TG920G			Globe Sight Match M18
TG921G	Green	.029"	Globe Sight Match M22
TG925G			Globe Sight Airgun



APPROVED BY  
THE GERMAN SHOOTING FEDERATION

TRUGLO® HUNTING / OPTICS 2017



# CHOKES TUBES

Make the most of your pattern, shot after shot.





# SSX STRUT•STOPPER™ XTREME

TURKEY CHOKE TUBE COMBO

## PRODUCT FEATURES

- Winner of 10 NWTF World Still Target Championships
- Awarded 6 NWTF World Records
- Designed by four-time winner of NWTF World Still Target Championship
- Accepts most turkey loads, including Hevi•Shot
- Internal grooves improve patterning
- Optimum construction for tight, dense patterns
- Precision CNC-machined
- Includes TG94D GOBBLE•DOT™ Universal DUAL•COLOR Fiber-Optic Sights (See page 23 for features)
- Endorsed by the National Wild Turkey Federation



TG150AXC



### Fiber-Optic Sights Included

TG94D GOBBLE•DOT™ Universal DUAL•COLOR Fiber-Optic Sights.

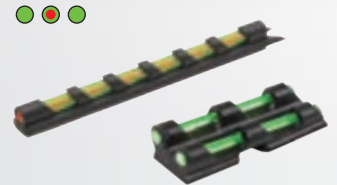

AWARD WINNING

CNC MACHINED

ULTRA-TIGHT PATTERN



ACCEPTS MOST TURKEY LOADS INCLUDING HEVI•SHOT



# GSX GOBBLE•STOPPER™ XTREME

TURKEY CHOKE TUBE COMBO

## PRODUCT FEATURES

- Our best selling turkey choke
- Precision CNC-machined
- Accepts most turkey loads, including Hevi•Shot
- Endorsed by the National Wild Turkey Federation
- Includes TG94 GOBBLE•DOT™ Universal Fiber-Optic Sights (See page 23 for features)



TG173XC

### Fiber-Optic Sights Included

TG94 GOBBLE•DOT™ Universal Fiber-Optic Sights.

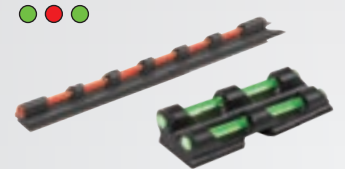

## MODEL SPECS

GAUGE	SSX MODEL	GSX MODEL	COMPATIBLE GUN MODELS
12	TG150XC (.643)	TG170XC (.665)	Remington® Remchoke 870 / 1100 / 11-87 / 887; Charles Daly® pumps / semi-automatics / Mossberg® Pro-Factor™ PF3
	TG150AXC (.643)	TG170AXC (.665)	Remington® Pro Bore
	TG151XC (.670)	TG171XC (.695)	Mossberg® 3.5 AccuChoke 835 Ulti-Mag / 935 Magnum
	TG152XC (.643)	TG172XC (.665)	Winchester® Winchoke 1200 / 1300 / 1400; Browning® Invector Series; Charles Daly® O/U; H&R® (excluding Excell automatic); Ithaca; Maverick Arms® 88™; Mossberg® 500 / 535 / 9200 / 930; New England Firearms®; SKB®; Stoeger® Coach / Condor / Uplander; Weatherby® / Mossberg® Pro-Factor™ PF1
	TG153XC (.643)	TG173XC (.665)	Benelli® Crio
	TG154XC (.643)	TG174XC (.665)	Beretta® OptimaChoke Plus
	TG154AXC (.643)	TG174AXC (.665)	Beretta® OptimaChoke HP
	TG155XC (.643)	TG175XC (.665)	Benelli® / Beretta® Mobilchoke; Franchi®; Stoeger® pumps / semi-automatics / Mossberg® Pro-Factor™ PF2 Silver Reserve
20	TG156XC (.643)	TG176XC (.665)	Browning® Invector Plus; Winchester® Super X2 / X3 / Supreme; Sako / Tikka
	TG157XC (.550)	TG177XC (.565)	Remington® Remchoke and most Charles Daly® / Mossberg® Pro-Factor™ PF3
	TG158XC (.550)	TG178XC (.565)	Winchester® WinChoke; Maverick Arms® 88™; Mossberg® AccuChoke 500 / 505 / 510 Mini / Mossberg® Pro-Factor™ PF1

AWARD WINNING

CNC MACHINED



ACCEPTS MOST TURKEY LOADS INCLUDING HEVI•SHOT





# TITAN ADJUSTABLE

CHOKE TUBE SERIES

## PRODUCT FEATURES

- The ultimate "screw-in" choke tube for waterfowl, wing and clay
- Allows shooter to quickly change settings without tools – simply turn the collar and click into position
- Choke settings are laser engraved
- Patterns from Cylinder to XX Full
- Recommended for shot sizes up to No. 1
- Endorsed by Ducks Unlimited



TG1005

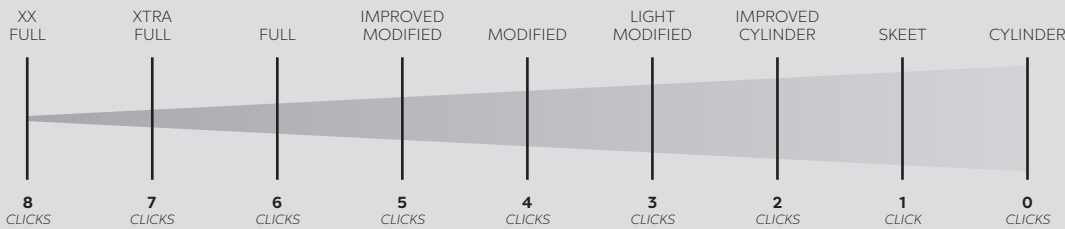

Please note: All settings are approximate.

## MODEL SPECS

GAUGE	TITAN MODEL	COMPATIBLE GUN MODELS
12	TG1000 (Adj.)	Remington® Remchoke 870 / 1100 / 11-87 / 887; Charles Daly® pumps / semi-automatics / Mossberg® Pro-Factor™ PF3
	TG1002 (Adj.)	Winchester® Winchoke 1200 / 1300 / 1400; Browning® Invictor Series; Charles Daly® O/U; H&R® (excluding Excell automatic); Ithaca; Maverick Arms® 88™; Mossberg® 500 / 535 / 9200 / 930; New England Firearms™; SKB®; Stoeger® Coach / Condor / Uplander; Weatherby® / Mossberg® Pro-Factor™ PF1
	TG1004 (Adj.)	Beretta® OptimaChoke Plus
	TG1005 (Adj.)	Benelli® / Beretta® Mobilchoke; Franchi®; Stoeger® pumps / semi-automatics / Mossberg® Pro-Factor™ PF2 Silver Reserve
	TG1006 (Adj.)	Browning® Invictor Plus; Winchester® Super X2 / X3 / Supreme; Sako / Tikka
20	TG1007 (Adj.)	Remington® Remchoke and most Charles Daly® / Mossberg® Pro-Factor™ PF3



ACCEPTS ALL WATERFOWL LOADS INCLUDING STEEL & HEVI•SHOT



DUCKS UNLIMITED OFFICIAL LICENSED PRODUCT



# TARGETS & ACCESSORIES

The critical components that help you make the most of your gear and your time – at the range or in the field.



# TRU•SEE™ TARGETS

HIGH-VISIBILITY REACTIVE / SPLATTER TARGETS



### Self-Adhesive Repair Dots

Cover your hits and shoot again!  
Included repair dots extend target life.

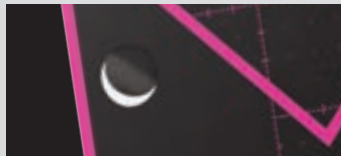

### ACCU•GRID Precision Sighting System

Accurate 1/4" measurements help you make precise sight adjustments.

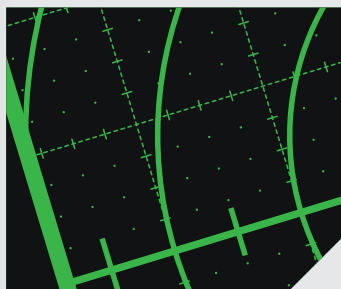

## PRODUCT FEATURES

- Ideal for shotguns, handguns, rifles, muzzleloaders and airguns
- Point-of-impact visibility is enhanced by a fluorescent green or pink halo
- Flat finish with fluorescent green or pink background is easy to see downrange
- Self-adhesive replacement dots extend target life (Not available on Turkey target)
- Shoot target as is or peel-and-stick the target to your favorite backstop
- Printed on heavy stock paper with a self-adhesive backing for increased target life

## MODEL SPECS

6-PACK	12-PACK	50-PACK	DESCRIPTION	COLOR
TG11A6	TG11A12	TG11A50	5-Bullseye	Green
TG11P6	—	—		Pink
TG14A6	TG14A12	TG14A50	5-Diamond	Green
TG14P6	—	—		Pink
TG13A6	TG13A12	TG13A50	Handgun	Green
TG13P6	—	—		Pink
TG10A6	TG10A12	TG10A50	100 Yard	Green
TG12A6	TG12A12	—	Turkey	Green

GREEN PINK

EASY TO SEE  
DOWNRANGE

ACCU•GRID  
SIGHTING SYSTEM

PEEL-AND-STICK  
TARGETS

SELF-ADHESIVE  
REPAIR DOTS



# TRU•BRITE™

10 x 42MM OPEN BRIDGE BINOCULARS

38

TARGETS & ACCESSORIES

## PRODUCT FEATURES

- Compact roof / BAK-4 prism design with phase coated prisms
- Single, ergonomic adjustment wheel for both focus and diopter settings
- Lockable diopter
- Long eye relief for use with eyewear
- Twist-up eyecups with click stops
- High transmission silver coating on prisms
- Textured surface provides a non-slip grip in all weather conditions
- Non-reflective matte finish
- Includes protective case



TG91042G

### Neoprene Strap Included

Comfortable padded neck strap supports your TRU•BRITE™ binoculars for easy access.



### Single Wheel Adjustment

Click adjustment wheel back to set diopter adjustment, then lock-in your diopter setting and click the wheel forward to adjust focus.

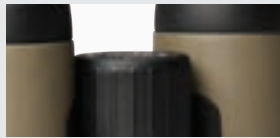

<b>MODEL</b>	<b>TG91042G</b>
<b>MAGNIFICATION</b>	10x
<b>OBJECTIVE DIAMETER</b>	42mm
<b>FOV (ANGULAR)</b>	6.5 degrees
<b>FOV (FT @ 1000 YDS)</b>	345
<b>CLOSE FOCUS</b>	8.2 feet
<b>EXIT PUPIL DIAMETER</b>	4.20mm
<b>INTERPUPILLARY DISTANCE</b>	58-73mm
<b>EYE RELIEF</b>	15mm
<b>DIOPTRIC COMPENSATION</b>	-4 / +4
<b>DIOPTRIC ADJUSTMENT</b>	Lockable diopter / center adjustment wheel
<b>PRISM TYPE / COMPOSITION</b>	Roof / BAK-4 Glass
<b>COATING</b>	Fully multi-coated / phase coated prisms
<b>PROTECTIVE CASE</b>	Yes
<b>NEOPRENE SHOULDER STRAP</b>	Yes
<b>UNIT DIMENSIONS (HxWxD)</b>	146x128x51mm
<b>WEIGHT (OUNCES)</b>	23.77

WATER PROOF

SHOCK RESISTANT

NITROGEN GAS-FILLED

FOG PROOF

MATTE FINISH

## HUNTER'S LITE™

- Multi-functional task light
- Hands-free operation
- Dual-position ON / OFF switch
- Flexible neck retains desired position
- Includes removable clip for convenient attachment to hats, belts, or jackets
- Attaches directly to clothing or other sporting equipment
- Bright blue LED



MODEL	LIGHT COLOR
TG982B	Blue

## GLO•BRITE™ PAINT KITS

- Increase visibility of firearm sights, adjustment knobs, and other details with high-visibility paints
- Adheres to metal, plastic, and many other materials with proper application



### GHOST GLOW PAINT KIT

MODEL	DESCRIPTION
TG985B	3 high-visibility gun sight coatings (green, orange and yellow) / 3 light-activated luminescent gun sight coatings (yellow, orange and green)

### BRITE SIGHT PAINT KIT

MODEL	DESCRIPTION
TG985A	5 high-visibility gun sight coatings (red, white, green, orange and yellow)

TRUGLO® HUNTING / OPTICS 2017

## REPLACEMENT FIBERS

- Replacement fiber-optic material for firearm and archery sights
- Efficient light transmission and vibrant color
- Available in a wide variety of colors and sizes



MODEL	LENGTH	DIAMETER	COLOR / QUANTITY
TG08A	9"	.029" (0.75mm)	Red (1), Green (2), Yellow (2)
TG08D		.019" (0.50mm)	
TG08M		Multi-diameter: .019" / .029" (0.50mm) / (0.75mm)	Red (1x .019", 1x .029"), Green (1x .019", 1x .029"), Yellow (1x .019", 1x .029")
TG09B	5.5"	.010" (0.25mm)	Blue (5)
TG09G		.010" (0.25mm)	Green (5)
TG05A		.029" (0.75mm)	Red (1), Green (1), Yellow (1), Ruby Red (1), Orange (1)
TG05B	.040" (1mm)		
TG05C	.060" (1.5mm)		
TG05D	.019" (0.50mm)		
TG05E	.078" (2mm)		
TG05F	.100" (2.5mm)	Ruby Red (3), Green (2)	
TG05CD	.060" (1.5mm)	DUAL-COLOR Red center / Green outside (5)	
TG05ED	.078" (2mm)		
TG05FD	.100" (2.5mm)		

Please note: Fiber diameter and length may vary per sight or installation application. Please check actual sight model before ordering.

## REPLACEMENT BATTERIES

- Replacement lithium batteries for TRUGLO® and other brand lights and electro-optical sights

MODEL	DESCRIPTION
TG988B	For HUNTER'S LITE™ model TG982B (2 per pack, 3V-CR2016)
TG988C	For all TRUGLO® Dot Optics and Illuminated Scopes (2 per pack, Lithium 3V-CR2032)

TG988C



## PICATINNY RISER MOUNTS

- Mounts to existing Picatinny rail
- CNC-machined aluminum
- Easy to install without modification
- Ideal for mounting scopes or dot optic sights
- Great for any AR-15 flattop

MODEL	STYLE	LENGTH	HEIGHT	MOUNTING	FINISH
TG8970B	1-Piece	4"	1/2"	Picatinny rail mount with recoil lug	Anodized matte black
TG8980B			3/4"		
TG8990B		2"	1"		
TG8971B (Fits TG8020B Red Dot)	2-Piece	1.36" Each	1/2"		
TG8972B			3/4"		
TG8982B			1"		
TG8992B					

TG8970B

TG8972B



## PICATINNY MOUNTING ADAPTER

- Converts 3/8" mounting bases into Picatinny or Weaver-style mounts
- Mounts to existing 3/8" rail
- CNC-machined aluminum
- Integrated adjustable recoil lug
- Easy to install without modification
- Accommodates all standard scope setups

MODEL	MOUNTING	FINISH
TG8953B	Picatinny rail mount with recoil lug	Anodized matte black

TG8953B





# DOT•OPTIC SPECS

SERIES / MODEL	LENGTH (inches)	LENGTH WITH SUNSHADE (inches)	WEIGHT (ounces)	POWER / OBJECTIVE LENS (x / mm)	OPTIC HEIGHT**	CO-WITNESS HEIGHT*	FIELD OF VIEW (feet@100yards)	EYE RELIEF (inches)	PARALLAX SETTING (in yards)	CLICK VALUE (inches@100yds)	RANGE OF ADJUSTMENT (inches@100yds)	RETICLE COLOR	RETICLE TYPE	BATTERY
<b>DUAL-COLOR / MULTI-RETICLE</b>														
TG8030MB	3.82	—	8.1	1X30	159	100	68	Unlimited	30	1	30	● ●	4 Reticle Patterns	CR2032
TG8030MB2	5.55	—	10.3	2X42	183	100	34	Unlimited	60	0.5	30	● ●	4 Reticle Patterns	CR2032
<b>DUAL-COLOR</b>														
TG8030DB	3.82	—	7.0	1X30	159	100	68	Unlimited	30	1	30	● ●	5-MOA Dot	CR2032
TG8030DBR	4.37	—	8.5	1X30	—	—	68	Unlimited	30	1	30	● ●	5-MOA Dot	CR2032
TG8030GB/GA	3.82	5.83	8.1	1X30	159	100	68	Unlimited	30	1	30	● ●	Circle Dot	CR2032
<b>TRADITIONAL</b>														
TG8030B/A	3.82	—	7.0	1X30	159	100	68	Unlimited	30	1	30	●	5-MOA Dot	CR2032
TG8030P	3.82	—	7.0	1X30	159	100	68	Unlimited	30	1	30	●	5-MOA Dot	CR2032
TG8040B	3.82	—	7.9	1X40	194	115	80	Unlimited	30	1	30	●	5-MOA Dot	CR2032
TG8030B2	5.50	—	9.2	2X42	183	100	34	Unlimited	60	0.5	30	●	2.5-MOA Dot	CR2032
<b>TRI-COLOR</b>														
TG8020B	2.83	—	6.4	1x20	134	0.95	46	Unlimited	30	1	30	● ● ●	5-MOA Dot	CR2032
TG8230B	3.85	—	8.0	1x30	161	1.02	68	Unlimited	30	1	30	● ● ●	5-MOA Dot	CR2032
TG8230GB	3.85	5.83	9.1	1x30	161	1.02	68	Unlimited	30	1	30	● ● ●	Circle Dot	CR2032
<b>OPEN (Tubeless)</b>														
TG8360B	3.23	—	4.4	1X34	187	140	74	Unlimited	30	1	30	● ●	4 Reticle Patterns	CR2032
TG8365B	3.43	4.25	5.5	1x28	213	158	68	Unlimited	30	1	30	● ● ●	4 Reticle Patterns	CR2032
TG8370B/C	3.54	—	4.3	1x34	187	140	74	Unlimited	30	1	30	● ●	5-MOA Dot	CR2032
TG8380B/BN	3.27	—	5.5	1x34	2.0	153	74	Unlimited	30	1	30	● ●	4 Reticle Patterns	CR2032
TG8385B/BN	3.48	—	5.5	1x34	2.0	153	74	Unlimited	30	1	30	● ●	5-MOA Dot	CR2032

\* Measured as the height between the top of the Weaver / Picatinny rail and the center of the optic.

\*\* Measured from top of Weaver / Picatinny rail to the top of optic (excluding turrets, buttons, etc)



## DOT

A traditional dot is great for simplicity, familiarity and speed. Our dot reticles are available in a variety of sizes and colors. A smaller dot is generally more precise, but a larger dot is faster to acquire and align.



## CENTER DOT

Our Center Dot reticle combines a traditional dot with a reference ring for faster acquisition. Listed size (in MOA) identifies the size of the central dot.



## CROSSHAIR

The illuminated Crosshair reticle provides a large shape that can be found quickly, and then centered for alignment like a traditional telescopic sight.



## PEEP

Our Peep reticle combines the Crosshair and Center Dot designs. Vertical and horizontal bars help the reticle to be found and positioned quickly, then the small central dot is used for precise aiming. Listed size (in MOA) identifies the size of the peep opening. (Negative space)



# SCOPE SPECS

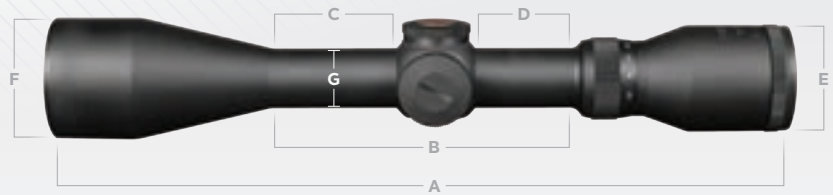

SERIES / MODEL	DIMENSIONS (inches)							WEIGHT (ounces)	MAG. (x)	OBJ. DIA. (mm)	FIELD OF VIEW (feet @ 100 yards)		EYE RELIEF (inches @ .75 diopter)		PARALLAX SETTING (yards)	CLICK VALUE (inches @ 100 yds.)	RANGE OF ADJUSTMENT (inches, all directions from center @ 100 yds.)	RETICLE TYPE	BATTERY
	A	B	C	D	E	F	G				High Power	Low Power	High Power	Low Power					
<b>TRU•BRITE™ XTREME</b>																			
<b>TG8539BXB</b>	11.12	4.25	1.47	1.40	1.80	2.01	1.00	17.3	3-9	44	12.1	37.4	4.75	5.50	100	0.25	30.0	2 Color IR BDC (Centerfire)	CR2032
<b>TG8539LXB</b>	13.11	6.46	2.46	2.68	1.80	2.01	1.00	18.2	3-9	44	11.52	32.25	4.3	4.3	100	0.25	35.0	2 Color IR BDC (Centerfire)	CR2032
<b>TG8531BXB</b>	12.20	5.00	2.09	1.65	1.80	2.01	1.00	17.5	3-12	44	8.6	31.1	4.50	5.00	100	0.25	20.0	2 Color IR BDC (Centerfire)	CR2032
<b>TG8541BXB</b>	13.89	5.12	2.17	1.57	1.80	2.36	1.00	22.8	4-16	50	5.7	24.2	4.50	5.00	15 - ∞	0.25	20.0	2 Color IR BDC (Centerfire)	CR2032
<b>TRU•BRITE™ MUZZLELOADER BDC</b>																			
<b>TG8531BLM</b>	12.28	4.80	1.85	1.46	1.80	2.00	1.00	17.1	3-12	44	8.64	31.1	4.25	5.25	100	0.25	20.0	2 Color IR BDC (Muzzleloader)	CR2032
<b>TRU•BRITE™ 30 HUNTER</b>																			
<b>T8514BC</b>	9.88	5.70	2.81	1.50	1.67	1.18	1.18	13.0	1-4	24	23.03	92.60	3.15	3.70	50	0.50	50	Circle Duplex	-
<b>COMPACT 4X32</b>																			
<b>TG8504BR</b>	9.80	3.80	1.60	1.06	1.46	1.46	1.00	12.5	4	32	-	20.79	-	5.50	100	0.25	30.0	Duplex	-
<b>TG8504BD/CD</b>	9.80	3.80	1.60	1.06	1.46	1.46	1.00	12.5	4	32	-	20.79	-	5.50	100	0.25	30.0	Diamond Ballistic	-
<b>TRUSHOT™</b>																			
<b>TG850432B</b>	11.30	5.75	2.50	2.13	1.54	1.54	1.00	9.7	4	32	-	33.41	-	3.94	50	0.25	30.0	Duplex	-
<b>TG852732B</b>	12.72	6.54	2.95	2.36	1.65	1.54	1.00	12.9	2-7	32	12.67	41.47	3.15	3.35	100	0.25	30.0	Duplex	-
<b>TG853932B</b>	11.46	5.63	2.60	1.97	1.54	1.54	1.00	12.9	3-9	32	12.67	47.23	3.35	3.94	100	0.25	30.0	Duplex	-
<b>TG853940B</b>	12.12	5.62	2.54	1.93	1.54	1.85	1.00	13.7	3-9	40	12.67	41.47	3.15	3.94	100	0.25	30.0	Duplex	-
<b>HUNT•TEC™</b>																			
<b>TG8504A</b>	8.07	3.09	0.84	1.01	1.61	1.54	1.00	12.5	4	32	5.8°	-	4.50	-	100	0.50	40.0	Duplex	-
<b>TG8504AL</b>	8.06	3.24	1.1	0.97	1.58	1.54	1.00	13.2	4	32	5.6°	-	4.50	-	100	0.50	40.0	IR Duplex	CR2032



## BDC

Bullet-Drop Compensating reticle can be easily calibrated to provide aiming points from 100 to 600 yards for centerfire loads and aiming points out to 300 yards for various muzzleloader bullet / powder combinations.



## DUPLEX

Duplex reticle provides fast target acquisition in any lighting condition.



## CIRCLE DUPLEX

Duplex reticle provides fast target acquisition with a simple circular frame of reference for patterning shotguns, ranging targets, or simple holdover reference.



## DIAMOND BALLISTIC

Specially designed for the deer or turkey hunter. Diamond reticle measures 5 inches at 40 yards.





# GUN MODEL COMPATIBILITY CHART

UNIVERSAL SIGHTS	TURKEY / MUZZLELOADER SIGHTS	WING SIGHTS	BEAD REPLACEMENT SIGHTS	BEAD THREAD
Ribbed shotgun barrels (including tapered)	<b>TG94, TG94D, TG950X, TG950XD, TG960</b>	<b>TG90, TG90D, TG90X, TG91, TG103UG, TG103UR, TG104G, TG104R</b>	<b>TG947UG, TG947UR, TG948UD, TG948UG, TG948UR, TG949, TG949D</b>	—
Plain shotgun barrels — 12 or 20 ga.	—	<b>TG92A, TG93A, TG92HA, TG93HA</b>	—	—
Plain shotgun barrels — 410 ga.	—	<b>TG92B, TG93B</b>	—	—
Muzzleloaders — Round barrel contour only	<b>TG131ML, TG958X</b>	—	—	—

The above "Universal Sightings" can be used in addition to any manufacturer specific sight listed below.

BERETTA®	TURKEY / SLUG SIGHTS	WING SIGHTS	BEAD REPLACEMENT SIGHTS	BEAD THREAD
AL390, AL391 Urika, A391 Xtrema, A400 Xplor Unico KO	<b>TG941XC, TG944C, TG962C</b>	<b>TG905X, TG957C</b>	<b>TG947C, TG948C, TG948CD, TG954D</b>	M2.6x0.45
Competition Models	—	—	<b>TG947C, TG948C, TG948CD, TG954D</b>	M2.6x0.45

BENELLI®	TURKEY / SLUG SIGHTS	WING SIGHTS	BEAD REPLACEMENT SIGHTS	BEAD THREAD
Legacy, M1 Field, Montefeltro, Super Black Eagle, Vinci. — 12 ga.	<b>TG941XD, TG944D, TG962D</b>	<b>TG904X</b>	<b>TG947C, TG948C, TG948CD, TG954D</b>	M2.6x0.45
Nova — 12 ga.	<b>TG941XD, TG944D, TG962D</b>	<b>TG904X</b>	<b>TG947C, TG948C, TG948CD, TG954D</b>	M2.6x0.45
Legacy, Montefeltro, Nova — 20 ga.	<b>TG941XC, TG944C, TG962C</b>	<b>TG905X, TG957C</b>	<b>TG947C, TG948C, TG948CD, TG954D</b>	M2.6x0.45

BROWNING®	TURKEY / SLUG SIGHTS	WING SIGHTS	BEAD REPLACEMENT SIGHTS	BEAD THREAD
Gold Series, A5	<b>TG941XC, TG944C, TG962C</b>	<b>TG905X</b>	—	M3x0.5
BPS, Gold Light 10	<b>TG941XD, TG944D, TG962D</b>	<b>TG904X</b>	<b>TG947E, TG948E, TG948ED, TG954E</b>	M3x0.5
BT-99, Citori, Cynergy	Ventilated ribs vary among 3/16" - 7/16"	Ventilated ribs vary among 3/16" - 7/16"	<b>TG947E, TG948E, TG948ED, TG954E</b>	M3x0.5*
Maxus, Silver	<b>TG941XA, TG942XA, TG944A, TG945, TG962A</b>	<b>TG901X, TG902X, TG103</b>	<b>TG947E, TG948E, TG948ED, TG954E</b>	M3x0.5

\*M1200, Superposed & older Citori's have 3-56 threads. Bead replacement sightings not recommended for A5 series. Universal series sightings are recommended for ribbed barrels.

CAESAR GUERINI®			BEAD REPLACEMENT SIGHTS	BEAD THREAD
All Shotguns	—	—	<b>TG947E, TG948E, TG948ED, TG954E</b>	M3x0.5

CHARLES DALY®	TURKEY / SLUG SIGHTS	WING SIGHTS	BEAD REPLACEMENT SIGHTS	BEAD THREAD
All Shotguns	<b>TG945, TG941XA, TG942XA, TG944A, TG962A</b>	<b>TG901X, TG902X, TG103</b>	<b>TG947E, TG948E, TG948ED, TG954E</b>	M3x0.5

FRANCHI®	TURKEY / SLUG SIGHTS	WING SIGHTS	BEAD REPLACEMENT SIGHTS	BEAD THREAD
Field Models	<b>TG941XC, TG944C, TG962C</b>	<b>TG905X</b>	<b>TG947E, TG948E, TG948ED, TG954E</b>	M3x0.5

HENRY®	TURKEY / SLUG SIGHTS			
Golden Boy .22 LR / Big Boy .44 MAG	<b>TG112</b>	—	—	—
Golden Boy .22 MAG / .17HMR, Big Boy .357 / .45 Colt	<b>TG114</b>	—	—	—

ITHACA	TURKEY / SLUG SIGHTS	WING SIGHTS	BEAD REPLACEMENT SIGHTS	BEAD THREAD
Model 37 (with 5/16" ventilated rib)	<b>TG941XD, TG944D, TG962D</b>	<b>TG904X</b>	<b>TG947A, TG948A, TG948AD, TG954A</b>	6-48
All Shotguns	—	—	<b>TG947A, TG948A, TG948AD, TG954A</b>	6-48

MARLIN®	TURKEY / SLUG SIGHTS			
Rimfire Rifles	<b>TG75G / TG75R</b>	—	—	—
Model 336 with front ramp	<b>TG109</b>	—	—	—
Lever Action Guide Rifles with front ramp	<b>TG112</b>	—	—	—

MOSSBERG®	TURKEY / SLUG SIGHTS	WING SIGHTS	BEAD REPLACEMENT SIGHTS	BEAD THREAD
500 Plain Barrel Shotgun	<b>TG92A, TG93A</b>	—	<b>TG947D, TG948D, TG948DD, TG954C</b>	5-40
500, 835, 9200 Shotgun	<b>TG941XB, TG942XB, TG944B, TG962B</b>	<b>TG911X, TG912X</b>	<b>TG947D, TG948D, TG948DD, TG954C</b>	5-40
Reserve Series O/U	—	—	<b>TG947E, TG948E, TG948ED, TG954E</b>	M3x0.5
695 Slug Gun	<b>TG961M</b>	—	—	—

NEW ENGLAND® / H&R® FIREARMS	TURKEY / SLUG SIGHTS	WING SIGHTS		
12 ga. Turkey Guns	—	TG92A, TG93A, TG92HA, TG93HA	—	
410 ga. Models	—	TG92B, TG93B	—	
Topper, Pardner, Excell	TG941XD, TG944D, TG962D	TG904X, TG945	—	
PERAZZI®			BEAD REPLACEMENT SIGHTS	BEAD THREAD
All Shotguns	—		TG947C, TG948C, TG948CD, TG954D	M2.6x0.45
REMINGTON®	TURKEY / SLUG / MUZZLELOADER SIGHTS	WING SIGHTS	BEAD REPLACEMENT SIGHTS	BEAD THREAD
870, 1100, 1187	TG941XA, TG942XA, TG944A, TG945, TG962A	TG957A†, TG901X, TG902X, TG103	TG947A†, TG948A†, TG948AD†, TG954A	***
SP-10	TG941XB, TG942XB, TG944B, TG962B	TG911X, TG912X	TG947A†, TG948A†, TG948AD†, TG954A	***
Shotgun Slug Barrels	TG961R, TG110W**	—	—	—
700 ADL, BDL, 7400, 7600 Rifles	TG961R, TG110W**	—	—	—
700 Series Muzzleloaders	TG110W	—	—	—
All Shotguns	—	—	TG947A†, TG948A†, TG948AD†, TG954A	6-48***
<p>* Excluding 2007 or later 870 Express.  ** Only fits two-piece front sights.  *** All 870 Express barrels and some 870, 1100 &amp; 1187 barrels have pressed beads, which can easily be tapped by a gunsmith. Bead replacement not recommended for Model 11 series. Universal series sights are recommended for ribbed barrels.  † Sight will install properly, but end of sight may extend slightly beyond end of ventilated rib.</p>				
RUGER®	TURKEY / SLUG / RIMFIRE RIFLE SIGHTS	WING SIGHTS	BEAD REPLACEMENT SIGHTS	BEAD THREAD
Red Label Shotguns	TG941XD, TG944D, TG962D	TG957E, TG904X	TG947B, TG948B, TG948BD, TG954F, TG954B	3-56
All Shotguns	—	—	TG947B, TG948B, TG948BD, TG954F, TG954B	3-56
10/22 Rifle (excludes Takedown®)	TG111W	—	—	—
SAVAGE® ARMS	TURKEY / SLUG SIGHTS	WING SIGHTS		
All Shotguns	TG941XD, TG944D, TG962D	TG904X	—	
SKB®			BEAD REPLACEMENT SIGHTS	BEAD THREAD
All Shotguns	—		TG947A, TG948A, TG948AD, TG954A	6-48
STOEGER®	TURKEY / SLUG SIGHTS	WING SIGHTS	BEAD REPLACEMENT SIGHTS	BEAD THREAD
Model 2000, P-350 Pump (all models)	TG941XD, TG944D, TG962D	TG904X	TG947C, TG948C, TG948CD, TG954D	M2.6x0.45
Condor Supreme, Uplander, Coach Gun & Double Defense	—	—	TG947D, TG948D, TG948DD, TG954C	5-40
TRADITIONS™	TURKEY / SLUG / MUZZLELOADER SIGHTS	WING SIGHTS		BEAD THREAD
Turkey II, Waterfowl II, ALS 2100 Field	TG945, TG941XA, TG942XA, TG944A, TG962A	TG901X, TG902X, TG103	—	—
VERONA	TURKEY / SLUG SIGHTS	WING SIGHTS	BEAD REPLACEMENT SIGHTS	BEAD THREAD
All Shotguns	TG945, TG941XA, TG942XA, TG944A, TG962A	TG901X, TG902X, TG103	—	Pressed Bead
WEATHERBY®	TURKEY / SLUG SIGHTS	WING SIGHTS	BEAD REPLACEMENT SIGHTS	BEAD THREAD
Orion (mfg by SKB)	TG941XB, TG942XB, TG944B, TG962B	TG911X, TG912X	TG947A, TG948A, TG948AD, TG954A	6-48
SA-08, PA-08 — 12 ga.	TG941XD, TG944D, TG962D	TG904X	TG947E, TG948E, TG948ED, TG954E	M3x0.5
Orion / Athena S/S — 12 / 20 ga. (tapered)	—	—	TG947E, TG948E, TG948ED, TG954E	M3x0.5
Orion / Athena O/U — 12 ga., SA-08 — 20 ga.	TG941XA, TG942XA, TG944A, TG962A. No Tru-Point Sights	TG901X, TG902X, TG103	TG947E, TG948E, TG948ED, TG954E	M3x0.5
Orion / Athena O/U — 20 ga.	TG941XC, TG944C, TG962C	TG905X	TG947E, TG948E, TG948ED, TG954E	M3x0.5
WINCHESTER®	TURKEY / SLUG / RIFLE SIGHTS	WING SIGHTS	BEAD REPLACEMENT SIGHTS	BEAD THREAD
1200, 1300, 1400, Super X2 Shotguns	TG941XB, TG942XB, TG944B, TG962B	TG911X, TG912X	TG947B, TG948B, TG948BD, TG954B	3-56*
Super X3 Shotguns	TG941XC, TG944C, TG962C	TG905X	TG947E, TG948E, TG948ED, TG954E	M3x0.5**
1300 Slug Barrels	TG961W	—	—	—
1300 Defender	—	TG92A, TG93A, TG92HA, TG93HA	—	—
Model 94 Rifle (with front ramp only)	TG112	—	—	—

\*Supreme and Super X2 barrels produced in 2003 or later have M3x0.5mm threads. \*\*Current production WIN SX-3 have 3-56 front bead thread.

Please note that manufacturers may periodically change specifications. We suggest contacting the manufacturer directly regarding specifications before ordering.

# COMMUNITY & CONSERVATION

TRUGLO® believes it is vitally important to support the hunting and shooting community in preservation of wild game, natural rights, youth training, and sporting competition.



ROCKY MOUNTAIN  
ELK FOUNDATION



NATIONAL WILD  
TURKEY FEDERATION



DUCKS  
UNLIMITED, INC.



ARCHERY TRADE  
ASSOCIATION MEMBER



YOUTH SHOOTING  
SPORTS ALLIANCE



HUNT OF A  
LIFETIME



NATIONAL SHOOTING  
SPORTS FOUNDATION



## AN INDUSTRY LEADER

IN OPTICS, FIREARM SIGHTS  
AND ACCESSORIES

**TRUGLO®**  
WHEN BRIGHTNESS COUNTS™

Copyright © 2016 TRUGLO, Inc

TRUGLO name, logo, and product trademarks are property of TRUGLO, INC. All other trademarks are property of their respective owners.

TRUGLO reserves the right to change products, specifications, models and prices without notice.

TRUGLO products are protected by one or more US and foreign patents.

# TRUGLO<sup>®</sup>

## TACTICAL



2017

**2017** PRODUCT CATALOG

# TABLE OF CONTENTS

## DOT•OPTICS

<b>ALL NEW</b> TRU•TEC™ XS.....	4-5
TRU•TEC™ 30MM.....	6-7
TRU•TEC™ 20MM <b>NEW MODEL AVAILABLE</b> .....	8-9
TRITON™ 30MM CANTILEVER.....	10
TRITON™ 30MM.....	11
DUAL•COLOR 30MM.....	11

## SCOPES

TACTICAL 30mm.....	13
TRU•BRITE™ 30 SERIES.....	14-15
TRU•BRITE™ XTREME.....	16

## HANDGUN SIGHTS

TFX™ PRO <b>NEW MODELS AVAILABLE</b> .....	18-19
TFX™ <b>NEW MODELS AVAILABLE</b> .....	20
TFO®.....	21
<b>ALL NEW</b> TRITIUM PRO.....	22
TRITIUM.....	23
FIBER-OPTIC.....	24
GLOCK® FRONT SIGHT TOOL.....	24

## SHOTGUN & RIFLE SIGHTS

TFX™ PRO REMINGTON® SHOTGUN SIGHTS.....	26
TFO® TACTICAL SHOTGUN FRONT SIGHT.....	26
FIBER-OPTIC UNIVERSAL SHOTGUN SIGHT.....	26
FIBER-OPTIC AR-15 FRONT GAS BLOCK SIGHT.....	27
TFO® AR-15 FRONT SIGHT POST.....	27

## LASERS

TRU•POINT™ LASER / LIGHT COMBO.....	29
MICRO•TAC™ TACTICAL MICRO LASER.....	30

## ACCESSORIES & TARGETS

TAC•POD™ ADJUSTABLE BIPODS.....	32
TACTICAL SCOPE MOUNT.....	33
<b>ALL NEW</b> OFFSET PICATINNY MOUNT.....	33
PICATINNY RISER MOUNTS.....	33
MOUNTING ADAPTER.....	33
REPLACEMENT BATTERIES.....	34
TRU•SEE™ TARGETS.....	34

## CHARTS

DOT•OPTICS TECHNICAL SPECIFICATIONS.....	36
SCOPE TECHNICAL SPECIFICATIONS.....	37
HANDGUN SIGHT FITTING CHART.....	38

DO NOT  
POST  
ON  
FACEBOOK

FAST AND

**PRECISE.**

DESIGNED FOR YOUR WEAPONS AND TRAINING.

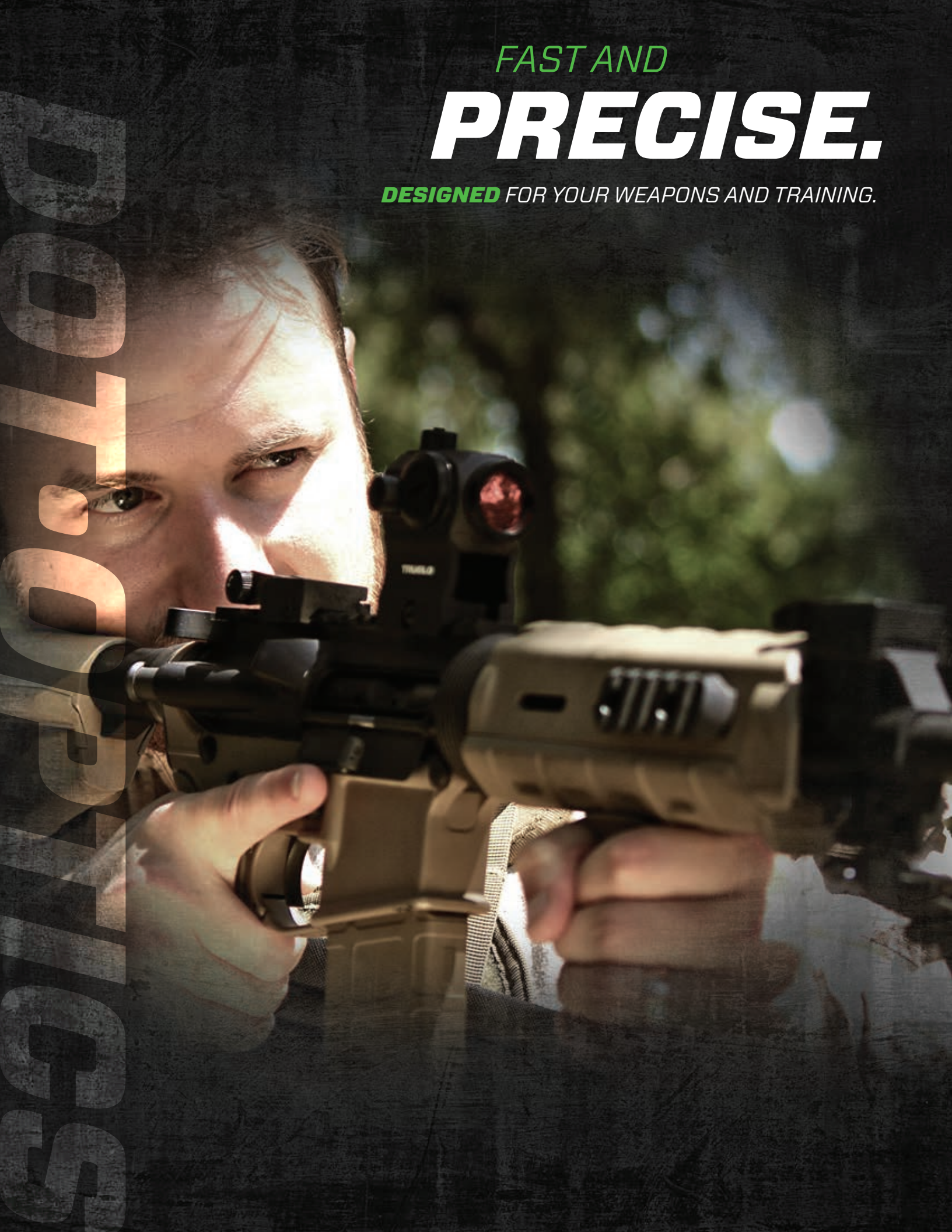

# TRU•TEC™ XS **NEW!**

## 30MM RED DOT SIGHT WITH CANTILEVER MOUNT

4

DOT•OPTICS

### 2-MOA Red Dot



### Absolute Co-Witness

Co-witness height matches A2 Front sight and standard flip-up sights for a consistent point of aim.



### Motion-Sensing Wake / Sleep

When the optic or weapon is moved at all, the dot is on. When the weapon sits idle for a programmable amount of time (10min, 1hr, or 12hrs) the dot will sleep to save power, waiting for your next move.

### Power Source

TG988C (3V-CR2032)  
Battery and spare battery tray included. See page 34 for replacement batteries.



Welcome the newest member of the TRU•TEC™ team, TRU•TEC XS. Building on favorite features of TRU•TEC 20mm and 30mm units, the XS takes a bold new stance with a rugged cantilever mount, positioned perfectly for back-up iron sights and other optical accessories. With new motion-sensing technology, the dot wake ups instantly and powers down when sitting idle to provide years of battery life.



## PRODUCT FEATURES

- Motion-sensitive wake feature automatically turns on the dot when the optic is moved
- 2-MOA reticle for precision aiming
- 30mm objective lens
- Digital push-button controls
- Multiple brightness settings
- Operates for thousands of hours on single CR2032 battery
- Programmable automatic sleep mode
- Click windage and elevation adjustments
- Machined aluminum cantilever Picatinny mount included
- Integrated lanyard system prevents loss of screw-down W/E caps
- Wide field of view
- Unlimited eye relief
- Optimal co-witness height for backup iron sights
- Flip-up lens caps included
- Ultra-durable design
- Water-resistant / fog-proof
- Mounts to standard Picatinny or Weaver-style rails
- Owner's manual included
- Requires one CR2032 battery (included)

TRUGLO® TACTICAL 2017



## MODEL SPECS

MODEL	POWER / OBJECTIVE	RETICLE TYPE	FINISH	CONSTRUCTION	ADJUSTABLE BRIGHTNESS	WINDAGE / ELEVATION	LENS CAPS	MOUNTING	BATTERY
<b>NEW</b> TG8135BN	1x 30mm	2-MOA Red Dot	Anodized Matte Black	Lightweight CNC-machined aluminum	Digital push-button controls	Click windage and elevation	Flip-up	Cantilever Picatinny mount included	3V-CR2032 Included

► See page 36 for additional specs.

MOTION SENSITIVE  
AUTO-ON

IDLE  
AUTO-OFF

ULTRA-LONG  
BATTERY LIFE

WATER  
RESISTANT

SHOCK  
RESISTANT

FOG  
PROOF



# TRU•TEC™ 30MM



## 30MM RED DOT SIGHT WITH INTEGRATED LASER

6

DOT•OPTICS

### 2-MOA Red Dot



TRU•TEC™ 30mm combines industry-leading features with tactile digital controls and an integral laser. Whether you want the dot in your optic or on your target, control is at your fingertips. Coated optics and a precise 2-MOA dot provide a bright, crisp image for superior accuracy. This robust system is shock resistant, water-resistant / fog-proof, and ready for just about anything.



**TG8130GN**  
Green Laser

### Power Source

TG988F (3V-CR123A)  
See page 34 for  
replacement batteries.



## PRODUCT FEATURES

- Ultra-durable design
- 2-MOA Reticle for precision aiming
- Water-resistant / fog-proof
- 30mm objective lens
- Digital push-button controls
- Programmable auto-off feature
- Flip-up lens caps included
- Next-generation, high-efficiency Green (520nm, TG8130GN) or Red (650nm, TG8130RN) laser diode
- Laser is independently adjustable for windage and elevation
- Mounts to standard Picatinny or Weaver-style rails
- Integrated wire lanyard system prevents loss of screw-down W/E caps
- Wide field of view
- Requires one CR123A battery (included)
- Multi-coated lenses for enhanced clarity and contrast

TRUGLO® TACTICAL 2017



**Quick Detach Lever**

quickly attaches to any Picatinny rail.



**Laser**

can be independently adjusted for windage and elevation.



TG8130BN



TG8130RN  
Red Laser

**MODEL SPECS**

MODEL	POWER / OBJECTIVE	RETICLE TYPE	LASER	FINISH	CONSTRUCTION	ADJUSTABLE BRIGHTNESS	WINDAGE / ELEVATION	LENS CAPS	MOUNTING	BATTERY
TG8130BN	1 x 30mm	2-MOA Red Dot	—	Anodized Matte Black	Lightweight CNC-machined aluminum	Digital push-button controls	Click windage and elevation	Flip-up	Integrated quick-detach rail mount	3V-CR123A Included
TG8130GN			Green							
TG8130RN			Red							

▶ See page 36 for additional specs.

- ▶ IDLE AUTO-OFF
- ▶ ULTRA-LONG BATTERY LIFE
- ▶ WATER RESISTANT
- ▶ SHOCK RESISTANT
- ▶ FOG PROOF
- ▶ NTOA APPROVED & RECOMMENDED

# TRU•TEC™ 20MM



## COMPACT 20MM RED DOT SIGHT

8  
DOT•OPTICS

### 2-MOA Red Dot



With included high and low mounting bases, and the now available quick-detach mounting bases, TRU•TEC™ 20mm is the go-to dot optic for nearly any weapon system. Compact and lightweight, TRU•TEC 20mm is ready for anything with a motion-sensitive auto-on and a programmable auto-off for years of reliable battery life. Coated optics and a precise 2-MOA dot provide a bright, crisp image for superior accuracy.



TG8120BN



TG8120QN  
Quick-Detach Lever

### High and Low Bases Included

CNC-machined aluminum maximizes strength while minimizing weight.

### Power Source

TG988C (3V-CR2032)  
See page 34 for replacement batteries.



## PRODUCT FEATURES

- 2-MOA reticle for precision aiming
- 20mm objective lens
- Quick-touch power on—tap anywhere on the optic to turn on
- Digital push-button controls
- Multiple brightness settings
- Ultra-long battery life—thousands of hours on a single battery
- Programmable auto-off feature (2hrs - 8hrs)
- Ultra-lightweight / compact design
- Click windage and elevation adjustments
- Wide field of view
- Unlimited eye relief
- Integrated Picatinny / Weaver-style mounting system
- Includes both low and high mounting bases
- Multi-coated lenses for enhanced clarity and contrast
- Requires one CR2032 battery (included)



**Quick Detach Lever**

quickly attaches to any Picatinny rail (Model TG8120QN)



High Base

Low Base



**CNC-machined aluminum** maximizes strength while minimizing weight

**MODEL SPECS**

MODEL	POWER / OBJECTIVE	RETICLE TYPE	FINISH	CONSTRUCTION	ADJUSTABLE BRIGHTNESS	WINDAGE / ELEVATION	LENS CAPS	MOUNTING	BATTERY
TG8120BN	1 x 20mm	2-MOA Red Dot	Anodized Matte Black	Lightweight CNC-machined aluminum	Digital push-button controls	Click windage and elevation	Rubber	High and low mounts included	3V-CR2032 Included
<b>NEW</b> TG8120QN								High quick-detach and standard low mount included	

▶ See page 36 for additional specs.

- ▶ MOTION SENSITIVE AUTO-ON
- ▶ IDLE AUTO-OFF
- ▶ ULTRA-LONG BATTERY LIFE
- ▶ WATER RESISTANT
- ▶ SHOCK RESISTANT
- ▶ FOG PROOF
- ▶ ULTRA LIGHTWEIGHT
- ▶ NTOA APPROVED & RECOMMENDED

# TRITON™ 30MM

LIMITED  
**LIFETIME**  
WARRANTY

TRI-COLOR DOT SIGHT WITH CANTILEVER MOUNT

10

DOT-OPTICS

TRI-COLOR



30mm  
**TG8230RB**

5-MOA DOT

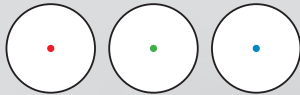

## Power Source

TG988C (3V-CR2032)  
Battery and spare battery  
included. See page 34 for  
replacement batteries.



Monolithic Mount  
**Included**

## PRODUCT FEATURES

- 5-MOA dot for rapid alignment
- Three choices of reticle color for contrast against any target / background (red, green or blue)
- Includes one-piece 30mm tactical mount with integrated adjustable recoil lug
- Multi-coated lenses produce more than 95% light transmittance
- Special anti-reflective interior eliminates stray light from appearing inside the sight

## MODEL SPECS

MODEL	POWER / OBJECTIVE	RETICLE TYPE	FINISH	CONSTRUCTION	ADJUSTABLE BRIGHTNESS	WINDAGE / ELEVATION	LENS CAPS	MOUNTING	BATTERY
TG8230RB	1x 30mm	5-MOA TRI-COLOR Dot	Anodized Matte Black	Lightweight CNC-machined aluminum	Rheostat controlled	Click windage and elevation	Flip-up	Cantilever Picatinny mount included	3V-CR2032

▶ See page 36 for additional specs.

TRI-COLOR

WATER RESISTANT

SHOCK RESISTANT

FOG PROOF

LIMITED LIFETIME WARRANTY

TRUGLO® TACTICAL 2017

# TRITON™ 30MM

## TRI•COLOR 30MM DOT SIGHT

### TRI•COLOR

#### 3-MOA CENTER DOT

Illuminated circle equals 20" at 25 yards.



#### Pressure Switch

Bonus ON / OFF momentary pressure switch included.



30mm  
TG8230TB

- Detachable, extended sunshade eliminates glare from the front lens
- Multi-coated lenses produce more than 95% light transmittance
- Integrated Weaver-style mounting system
- Includes bonus remote ON / OFF momentary pressure switch

### MODEL SPECS

MODEL	POWER / OBJECTIVE	RETICLE TYPE	FINISH	CONSTRUCTION	ADJUSTABLE BRIGHTNESS	WINDAGE / ELEVATION	LENS CAPS	MOUNTING	BATTERY
TG8230TB	1 x 30mm	3-MOA TRI•COLOR Center Dot	Anodized Matte Black	Lightweight CNC-machined aluminum	Rheostat controlled	Click windage and elevation	Flip-up	Integrated rail mount	3V-CR2032 Included
TG8230TBN (Boxed)									

▶ See page 36 for additional specs.

▶ TRI COLOR

▶ WATER RESISTANT

▶ SHOCK RESISTANT

▶ FOG PROOF

▶ LIMITED LIFETIME WARRANTY

# DUAL•COLOR™

## DUAL•COLOR 30MM DOT SIGHT

#### 3-MOA CENTER DOT

Illuminated circle equals 20" at 25 yards.

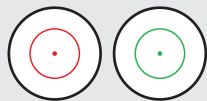

#### Power Source

Includes a spare battery storage compartment and spare battery. TG988C (3V-CR2032) See page 34 for replacement batteries.



30mm  
TG8030TB

- Detachable, extended sunshade eliminates glare from the front lens
- Multi-coated lenses produce more than 95% light transmittance
- Flip-up lens caps / lanyard system

### MODEL SPECS

MODEL	POWER / OBJECTIVE	RETICLE TYPE	FINISH	CONSTRUCTION	ADJUSTABLE BRIGHTNESS	WINDAGE / ELEVATION	LENS CAPS	MOUNTING	BATTERY
TG8030TB	1 x 30mm	3-MOA DUAL•COLOR Center Dot	Anodized Matte Black	Lightweight CNC-machined aluminum	Rheostat controlled	Click windage and elevation	Flip-up	Integrated rail mount	3V-CR2032 Included

▶ See page 36 for additional specs.

▶ DUAL COLOR

▶ WATER RESISTANT

▶ SHOCK RESISTANT

▶ FOG PROOF

▶ LIMITED LIFETIME WARRANTY

GOING THE

***DISTANCE.***

COOPER  
S



# TACTICAL 30MM

LIMITED  
LIFETIME  
WARRANTY

13

RIFLE SCOPES

## 3-9 x 42MM ILLUMINATED-RETICLE RIFLE SCOPE WITH MOUNT

### ILLUMINATED DUPLEX MIL-DOT

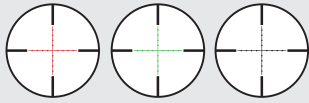

3-9 x 42mm  
TG8539TL

Bright 42mm  
Objective Lens

Monolithic  
Scope Mount

### MIL-DOT Reticle

Enables the user to determine the distance of objects of a known size and provides quick trajectory and wind drift aiming reference.

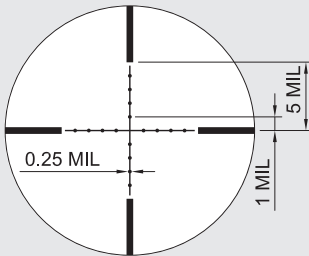

### Power Source

TG988C (3V-CR2032)  
See page 34 for  
replacement batteries.

## PRODUCT FEATURES

- Scope includes reversible, offset, monolithic 30mm scope mount CNC-machined from aircraft grade aluminum
- Scope includes two pre-calibrated BDC turrets in calibers .223 (55 grain) and .308 (168 grain) to engage targets up to 600 yards away
- Reticle can be used in black without illumination
- Generous 4" eye relief

## MODEL SPECS

MODEL	POWER / OBJECTIVE	RETICLE TYPE	FINISH	CONSTRUCTION	ADJUSTABLE BRIGHTNESS	WINDAGE / ELEVATION	LENS CAPS	MOUNTING	BATTERY
TG8539TL	3-9 x 42mm	Illuminated Duplex Mil-Dot	Anodized matte black	One-piece aircraft quality aluminum tube	Rheostat controlled	Durable leaf spring - fingertip adjustments. Interchangeable BDC elevation turrets	Flip-up	Monolithic aluminum mount included	3V-CR2032 Included

➤ See page 37 for additional specs.

DUAL  
COLOR

WATER  
RESISTANT

SHOCK  
RESISTANT

NITROGEN  
GAS-FILLED

FOG  
PROOF

LIMITED LIFETIME  
WARRANTY



# TRU·BRITE™ 30 SERIES

## 30MM ILLUMINATED-RETICLE RIFLE SCOPE

14

RIFLE SCOPES

### TG8516TL ILLUMINATED POWER RING DUPLEX MIL-DOT

Illuminated circle equals 24" at 30 yards.



### TG8514BT DUPLEX MIL-DOT



TRU·BRITE™ 30 Series offers the perfect combination of clarity, precision, and speed. Featuring a 30mm tube and your choice of 1-4x or 1-6x magnification, TRU·BRITE 30 provides a bright image and extremely wide field of view. With true 1x magnification, shooters can utilize an extremely fast sight picture and even take the shot with both eyes open.

LIMITED  
**LIFETIME**  
WARRANTY



Included  
**Quick Zoom Lever**

1-6 x 24mm  
**TG8516TL**

### Power Source

For TG8516TL only: TG988C  
(3V-CR2032) See page 34 for  
replacement batteries.



## PRODUCT FEATURES

- Scope includes reversible, offset, monolithic 30mm scope mount CNC-machined from aircraft grade aluminum
- Scope includes two pre-calibrated BDC turrets in calibers .223 (55 grain) and .308 (168 grain) to engage targets up to 800 yards away
- Reticle can be used without illumination (black)
- Generous 4" eye relief

TRUGLO® TACTICAL 2017



**BDC Turrets**

Each TRU•BRITE™ 30 scope includes two pre-calibrated BDC turrets in calibers .223 (55 grain) and .308 (168 grain) to engage targets up to 800 yards away.



1-4 x 24mm  
**TG8514BT**



**MODEL SPECS**

MODEL	POWER / OBJECTIVE	RETICLE TYPE	FINISH	CONSTRUCTION	ADJUSTABLE BRIGHTNESS	WINDAGE / ELEVATION	LENS CAPS	QUICK ZOOM LEVER	MOUNTING
TG8516TL	1-6 x 24mm	Illuminated Duplex Mil-Dot	Anodized matte black	One-piece aircraft quality aluminum tube	Rheostat controlled	Durable leaf spring – fingertip adjustments. Interchangeable BDC elevation turrets	Flip-up	Yes	Monolithic aluminum mount included
TG8514BT	1-4 x 24mm	Duplex Mil-Dot	Anodized matte black	One-piece aircraft quality aluminum tube	—	—	No		

▶ See page 37 for additional specs.

- ▶ DUAL COLOR
- ▶ WATER RESISTANT
- ▶ SHOCK RESISTANT
- ▶ FOG PROOF
- ▶ LIMITED LIFETIME WARRANTY

# TRU·BRITE™ XTREME

4 x 32MM ILLUMINATED-RETICLE COMPACT RIFLE SCOPE

16

RIFLE SCOPES

## MIL-DOT

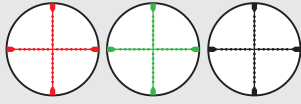

## Mil-Dot Reticle

Enables the user to determine the distance of objects of a known size and provides quick trajectory and wind drift aiming reference.

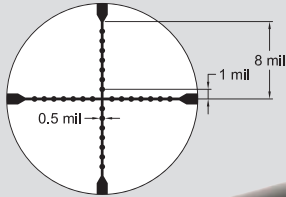

A fixed 4-power scope has been a long-standing favorite for combat optics—enough magnification to give you that added distance and precision, but not enough to slow you down up close. TRU·BRITE™ XTREME builds on that idea with a Mil-dot reticle, built-in sunshade, dual-color illumination, and an available mount optimized for AR-15 / M4-style carbines.



LIMITED  
LIFETIME  
WARRANTY

## Power Source

For TG8504TL / TG8504TLN only: TG988C (3V-CR2032)  
See page 34 for replacement batteries.



## PRODUCT FEATURES

- Models TG8504TL / TLN include Dual-Color reticle illumination (red and green)
- Reticle can be used in without illumination (black)
- Generous 4" eye relief
- Fully-coated lenses provide maximum brightness, clarity and contrast
- Durable, scratch-resistant, non-reflective matte finish

## MODEL SPECS

MODEL	POWER / OBJECTIVE	RETICLE TYPE	FINISH	CONSTRUCTION	ADJUSTABLE BRIGHTNESS	WINDAGE / ELEVATION	LENS CAPS	MOUNTING	BATTERY
TG8504TL	4 x 32mm	Illuminated Mil-Dot	Anodized Matte Black	One-piece aircraft quality aluminum tube	Rheostat controlled	Click windage and elevation	Elastic	Scope rings included	3V-CR2032 Included
TG8504TLN (Boxed)									
TG8504BTN (Boxed)		Mil-Dot							
TG8504BT									

▶ See page 37 for additional specs.

▶ DUAL COLOR ▶ WATER RESISTANT ▶ SHOCK RESISTANT ▶ NITROGEN GAS-FILLED ▶ FOG PROOF ▶ LIMITED LIFETIME WARRANTY

*CARRY YOUR SIDEARM*

# ***OUT OF THE DARK AGES.***

WADSWORTH SIGNS



## NEXT GENERATION TRITIUM + FIBER-OPTIC XTREME HANDGUN SIGHTS

18

HANDGUN SIGHTS

**NEW!**

### MODELS FOR 2017

- Ruger® American 9mm & 45 ACP
- Walther® CCP
- Walther® PPS M2

First we created the original TFO® day / night sight, then made it virtually indestructible with our hermetically-sealed TFX™ capsules. Next, we took TFX™ technology even further for professionals and shooters requiring maximum performance from their handguns—providing ultimate reliability, accuracy, and brightness no matter how tough things get. With even more models available in the TFX PRO lineup, it is even easier to top all of your favorite pistols with the world's best handgun sights.



### Sealed Capsule Design

Provides maximum protection and durability.



TFX™ Pro  
TG13GL1PC

## PRODUCT FEATURES

- Contrasting colored front sight FOCUS·LOCK ring for even faster focus
- Quick and accurate U-notch Design
- Angled rear sight edge for emergency one-hand operation
- All features of our popular TFX™ Handgun sights (page 20)
- Unmatched visibility in all shooting conditions 24/7
- Assembled in USA with quality Swiss Tritium for maximum brightness
- Glows-in-the-dark
- No batteries required
- Concealed fiber cannot be seen by target
- FORTRESS FINISH™ provides a permanent protective coating for maximum protection
- Fits standard holsters
- Evaluated and recommended by National Tactical Officers' Association (NTOA) field testers
- Patented

TRUGLO® TACTICAL 2017

“ANY SUFFICIENTLY ADVANCED TECHNOLOGY IS INDISTINGUISHABLE FROM MAGIC...”

—ARTHUR C. CLARKE

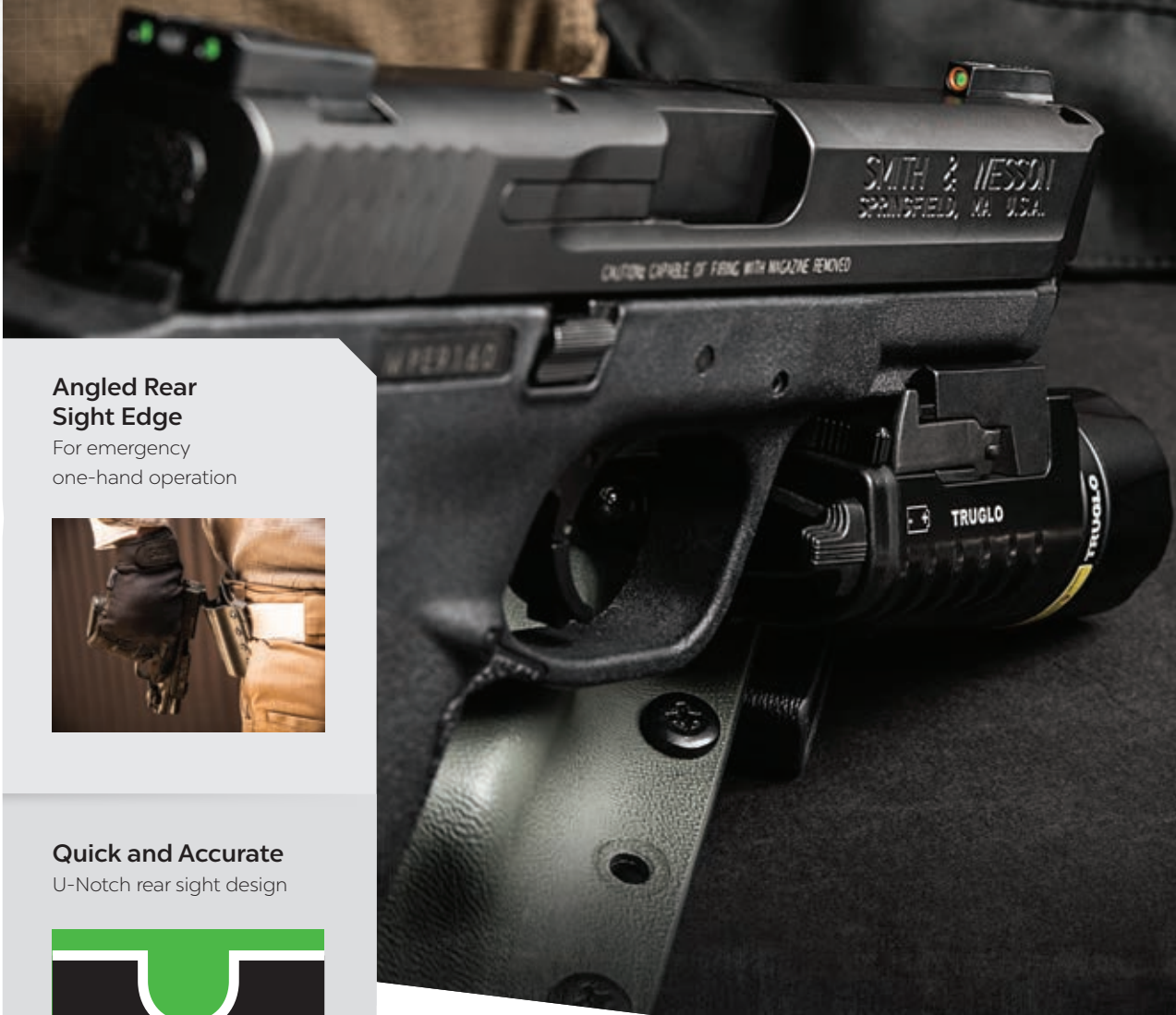

**Angled Rear Sight Edge**

For emergency one-hand operation



**Quick and Accurate**

U-Notch rear sight design



**MODEL SPECS**

	MODEL	FIBER-OPTICS	TRITIUM	SEALED CAPSULE	FOCUS•LOCK	NOTCH STYLE	REAR SIGHT PROFILE
	TFX™ PRO	Green front and rear	Yes	Yes	Orange	U-notch	Hooked

▶ Please see chart page 38 for complete listing of all sub-models and compatibility.

- ▶ FOCUS LOCK
- ▶ U-NOTCH REAR SIGHT
- ▶ TFX SEALED CAPSULE
- ▶ HOOKED REAR SIGHT PROFILE
- ▶ FORTRESS FINISH
- ▶ DUTY PROVEN
- ▶ CNC-MACHINED STEEL
- ▶ 24/7 BRIGHTNESS
- ▶ 12-YEAR LIMITED WARRANTY
- ▶ ASSEMBLED IN THE USA 
- ▶ NTOA APPROVED & RECOMMENDED



## TRITIUM + FIBER-OPTIC XTREME HANDGUN SIGHTS

20

HANDGUN SIGHTS

### Sealed Capsule Design

Provides maximum protection and durability.



*Glowing bright both day and night, TFX™ sights are always ready. TFX™ takes our award-winning Tritium + Fiber-Optic technology even further with all the features our customers requested: compact snag-free design, longer sight radius, and amazingly durable construction built to handle just about anything. Illuminating elements are encased inside a virtually indestructible chemical and shock-resistant capsule and the CNC-machined steel is protected with a rust-resistant FORTRESS FINISH™. The white FOCUS•LOCK ring surrounding the front fiber makes it even more visible, encouraging the eye to rapidly focus on the front sight for improved speed and accuracy. TFX™ sights will amaze even the most discriminating shooters.*

### Suppressor-Height Models

Available for Glock® Pistols. (TG13GL4A, TG13GL5A).



## PRODUCT FEATURES

- Fully protected TFO® technology encapsulated in a virtually indestructible configuration
- Impervious to oils, chemicals, cleaning solvents and ultra-sonic cleaning processes
- Unmatched visibility in all shooting conditions 24/7
- Assembled in USA with quality Swiss Tritium for maximum brightness
- Glows-in-the-dark — no batteries or light exposure required
- Front sight FOCUS•LOCK for fast and accurate shooting
- Concealed fiber cannot be seen by target
- FORTRESS FINISH™ provides a permanent protective coating for maximum protection
- Fits standard holsters
- Evaluated and recommended by National Tactical Officers' Association (NTOA) field testers
- Patented

## MODEL SPECS

	MODEL	FIBER-OPTICS	TRITIUM	SEALED CAPSULE	FOCUS•LOCK	NOTCH STYLE	REAR SIGHT PROFILE
	TFX™	Green front and rear	Yes	Yes	White	Square-notch	Smooth

▶ Please see chart page 38 for complete listing of all sub-models and compatibility.

TRUGLO® TACTICAL 2017

▶ FOCUS LOCK

▶ TFX SEALED CAPSULE

▶ FORTRESS FINISH

▶ CNC-MACHINED STEEL

▶ 12-YEAR LIMITED WARRANTY

▶ NTOA APPROVED & RECOMMENDED

▶ DUTY PROVEN

▶ 24/7 BRIGHTNESS

▶ ASSEMBLED IN THE USA

## TRITIUM + FIBER-OPTIC HANDGUN SIGHTS

The better you can see your sights, the better you can shoot. We brought fiber-optics to the shooting sports industry decades ago for this very reason. TFO® pairs our fiber-optic sights with our tritium night sights to create a consistently bright sight picture—day or night! Our patented combination of Tritium and Fiber-Optic technologies unites the best of both worlds — providing the same bright sight picture whether you are in glaring daylight or complete darkness.



### PRODUCT FEATURES

- The first of it's kind!
- Unmatched visibility in all shooting conditions 24/7
- Assembled in USA with quality Swiss Tritium for maximum brightness
- Glows-in-the-dark
- No batteries required
- Concealed fiber cannot be seen by target
- Available with green or yellow rear sights
- FORTRESS FINISH™ provides a permanent protective coating for maximum protection
- Snag resistant design / fits standard holsters
- Patented

### MODEL SPECS

	MODEL	FIBER-OPTICS	TRITIUM	SEALED CAPSULE	FOCUS·LOCK	NOTCH STYLE	REAR SIGHT PROFILE
	TFO®	Green front, Green or Yellow rear	Yes	—	—	Square-notch	Smooth

► Please see chart page 38 for complete listing of all sub-models and compatibility.

DUTY PROVEN

24/7 BRIGHTNESS

ASSEMBLED IN THE USA

FORTRESS FINISH

CNC-MACHINED STEEL

12-YEAR LIMITED WARRANTY



**NEW!**

# BRITE·SITE™ TRITIUM PRO

## HANDGUN NIGHT SIGHTS

22

HANDGUN SIGHTS

### All New For 2017

All models are brand new, now including dedicated sights for Glock® MOS™, Ruger® American, and the Smith & Wesson® Bodyguard .380.



### Quick and Accurate

U-Notch rear sight design.



Simply put, TRUGLO® manufactures bright ideas. When TFX™ PRO sights immediately took off and gained critical acclaim, we noticed that the world of TRITIUM night sights needed a similar upgrade. Starting with the brightness and durability of our original TRITIUM night sights, we added all of our PRO level features to give you the advantage when you need it the most.



TRITIUM PRO  
TG231G1W

## PRODUCT FEATURES

- Front sight FOCUS·LOCK ring for even faster focus
- Quick and accurate U-notch Design
- Angled rear sight edge for emergency one-hand operation
- Assembled in USA with quality Swiss Tritium for maximum brightness
- Unmatched visibility in low-light shooting conditions or complete darkness
- Utilizes quality Swiss tritium for maximum brightness
- Glows-in-the-dark – no batteries or light exposure required
- FORTRESS FINISH™ provides a permanent protective coating for maximum protection
- Snag resistant design / fits standard holsters

## MODEL SPECS

	MODEL	FIBER-OPTICS	TRITIUM	FOCUS·LOCK	NOTCH STYLE	REAR SIGHT PROFILE
	Tritium PRO	—	Yes	White	Square-notch	Hooked

▶ Please see chart page 38 for complete listing of all sub-models and compatibility.

TRUGLO® TACTICAL 2017

NIGHT SIGHTS

U-NOTCH REAR SIGHT

HOOKED REAR SIGHT PROFILE

ASSEMBLED IN THE USA

FOCUS LOCK

FORTRESS FINISH

CNC-MACHINED STEEL

12-YEAR LIMITED WARRANTY

NTOA APPROVED & RECOMMENDED

# BRITE·SITE™ TRITIUM

## HANDGUN NIGHT SIGHTS

When the lights go out, your sidearm doesn't need to be left in the dark. Tritium night sights transition from standard white dot sights during the daylight, to glowing green dots in the dark. Tritium does not need batteries and does not need to be charged with light – it simply glows!



Daylight: Bright White Dots

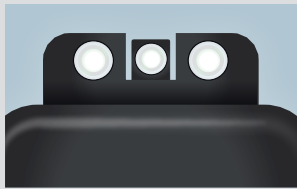

Night: Green Tritium Dots



### PRODUCT FEATURES

- Unmatched visibility in low-light shooting conditions or complete darkness
- Glows-in-the-dark
- Assembled in USA with quality Swiss Tritium for maximum brightness
- No batteries required
- FORTRESS FINISH™ provides a permanent protective coating for maximum protection
- Snag resistant design
- Fits standard holsters

### MODEL SPECS

	MODEL	FIBER-OPTICS	TRITIUM	FOCUS·LOCK	NOTCH STYLE	REAR SIGHT PROFILE
	Tritium	–	Yes	–	Square-notch	Smooth

► Please see chart page 38 for complete listing of all sub-models and compatibility.

NIGHT SIGHTS

DUTY PROVEN

ASSEMBLED IN THE USA 

FORTRESS FINISH

CNC-MACHINED STEEL

12-YEAR LIMITED WARRANTY

# BRITE·SITE™ FIBER-OPTIC

## FIBER-OPTIC HANDGUN SIGHTS

24

HANDGUN SIGHTS



### PRODUCT FEATURES

- Fiber-optics for the brightest aiming points even in low-light conditions
- TRI·DOT™ aiming system of contrasting front and rear colors
- Concealed fiber cannot be seen by target
- FORTRESS FINISH™ provides a permanent protective coating for maximum protection
- Snag resistant design
- Fits standard holsters

### MODEL SPECS

	MODEL	FIBER-OPTICS	TRITIUM	FOCUS·LOCK	NOTCH STYLE	REAR SIGHT PROFILE
	Fiber-Optic	Red front, Green rear	—	—	Square-notch	Smooth

▶ Please see chart page 38 for complete listing of all sub-models and compatibility.

DUTY PROVEN

ASSEMBLED IN THE USA

FORTRESS FINISH

CNC-MACHINED STEEL

# GLOCK® FRONT SIGHT TOOL

## ASSEMBLED IN THE USA

### PRODUCT FEATURES

- Easily removes / installs Glock® and Walther® front sights
- All-steel construction



TG970GF

TRUGLO® TACTICAL 2017

SHOTGUN & RIFLE SIGHTS



*ADAPT AND*  
**ADVANCE.**

UPGRADE YOUR SIGHTING SYSTEM TO BE MORE EFFECTIVE  
**WHEN BRIGHTNESS COUNTS™.**

# TFX PRO<sup>®</sup>

## REMINGTON<sup>®</sup> SHOTGUN SIGHTS

### Quick and Accurate

U-Notch rear sight design.



- Front sight utilizes TFO<sup>®</sup> technology for 24/7 Brightness
- Uses the brightest Swiss tritium available
- Glows-in-the-dark
- No batteries required
- Concealed fiber cannot be seen by target
- Fits Remington<sup>®</sup> Shotguns with dovetail sight mounts

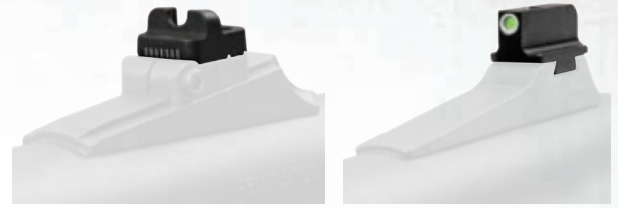

### MODEL SPECS

MODEL	REAR SIGHT	FIBER-OPTICS	TRITIUM	FOCUS-LOCK
TG13RM1PB	U-Notch	Yes	Yes	White

TFX SEALED CAPSULE    24/7 BRIGHTNESS    12-YEAR LIMITED WARRANTY    ASSEMBLED IN THE USA

# TFO<sup>®</sup>

## TACTICAL SHOTGUN FRONT SIGHT

- Unbelievable transition through all light conditions
- Uses the brightest Swiss tritium available
- Glows-in-the-dark
- Oversized fiber-optic for fast sight acquisition
- No batteries required
- Concealed fiber cannot be seen by target
- UNIVERSAL – Fits 12 ga. shotguns without rib



### MODEL SPECS

MODEL	FIBER-OPTICS	TRITIUM	FIBER COLOR
TG131SG	Yes	Yes	Green

24/7 BRIGHTNESS    12-YEAR LIMITED WARRANTY    ASSEMBLED IN THE USA

# FIBER-OPTIC

## UNIVERSAL SHOTGUN SIGHT

- Designed for plain barrel shotguns
- Easy installation
- Extremely low profile
- Ultra-tough construction
- Fiber diameter is .078"
- UNIVERSAL – Fits 12-20 ga. shotgun barrels without rib



### MODEL SPECS

MODEL	GAUGE	FIBER COLOR
TG92HA	12-20	Red
TG93HA		Green

UNIVERSAL FIT

# FIBER-OPTIC

## AR-15 FRONT GAS BLOCK SIGHT

### Light Included

For a bright front sight in daylight or complete darkness.



- The industry's brightest AR-15 fiber-optic gun sight
- Extra-long, super bright, protected green fiber
- Integral mount for Picatinny rails
- Click elevation adjustment
- Designed to mount on lower front gas blocks
- Includes sight adjustment tool
- Includes optional push-button light for use in complete darkness
- CNC-machined construction

### MODEL SPECS

MODEL	FIBER-OPTICS	TRITIUM	FIBER COLOR			
TG115	Yes	Yes	Green			
		▶ 24/7 BRIGHTNESS	▶ PUSH-BUTTON LIGHT	▶ FORTRESS FINISH	▶ CNC-MACHINED STEEL	

# TFO<sup>®</sup>

## AR-15 FRONT SIGHT POST

### Easily Upgrade A2-Style Front Sights

To be more effective with increased visibility in all lighting conditions and even complete darkness.



- Replaces sight post in A2-style front sights
- Unbelievable transition through all light conditions
- Uses the brightest Swiss tritium available
- Glows-in-the-dark
- No batteries required
- Click elevation adjustment
- Includes sight removal / installation tool

### MODEL SPECS

MODEL	FIBER-OPTICS	TRITIUM	FIBER COLOR			
TG131AR	Yes	Yes	Green			
		▶ 24/7 BRIGHTNESS	▶ ASSEMBLED IN THE USA	▶ FORTRESS FINISH	▶ CNC-MACHINED STEEL	▶ 12-YEAR LIMITED WARRANTY

*BRIGHT SIGHTING SYSTEMS*

# ***EXTENDING BEYOND***

*YOUR OWN WEAPON.*

AS  
S  
E  
R  
S

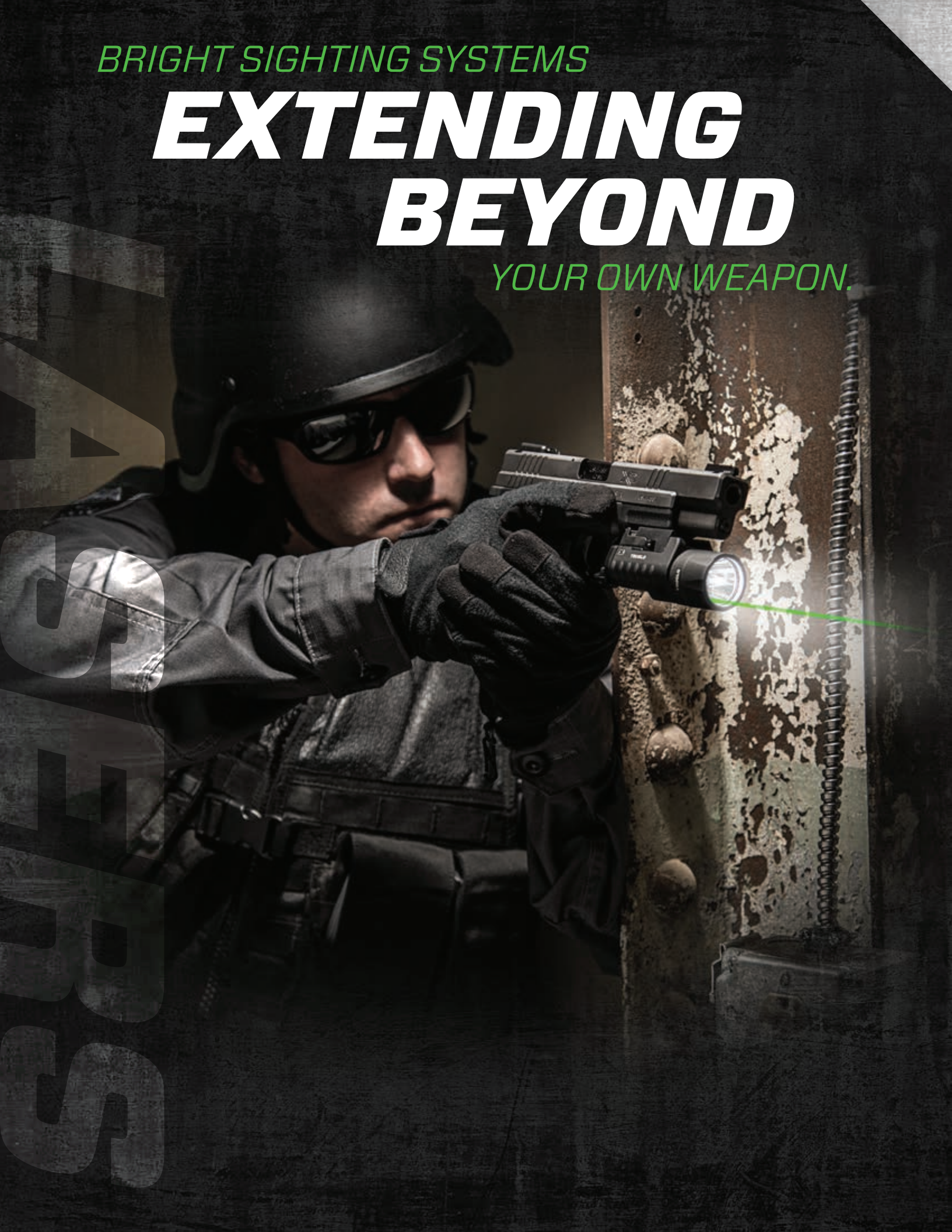

## LASER / LIGHT COMBO

### Laser / Light Modes

Constant Laser



Flashlight



Flashlight and Laser

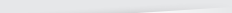

### Quick-Detach Lever

Quickly attaches to any Picatinny rail.



### Versatile

Designed for maximum compatibility with rifle, pistol and shotgun.



### Power Source

TG988F (3V-CR123A)  
Batteries included. See page 34 for replacement batteries.

Why choose between a light or a laser when you can have both? TRU•POINT brings the power of illumination options to the rail of your favorite weapon. With the flick of a switch, choose between a laser for pinpoint accuracy, a 250 lumen medium flood LED light for target identification, or run them at the same time for the best of both world's.



Laser / Light Combo  
**TG7650G**

## PRODUCT FEATURES

- Laser located in flashlight housing for a more compact design
- Interchangeable back plates for left or right-hand use included
- Mounts to standard Picatinny or Weaver-style rails
- Quick-detach lever for fast and easy, tool-less removal
- Powerful 520nm green laser (TG7650G)
- Powerful 650nm red laser (TG7650R)
- Operating temperature: 14°F (-10°C) to 122°F (50°C)
- Remote momentary pressure ON / OFF switch also included

## MODEL SPECS

MODEL	LASER COLOR	FINISH	CONSTRUCTION	MODES	ADJUSTMENTS	MOUNTING	QUICK RELEASE	BATTERY
TG7650G	Green	Satin black	Lightweight CNC-machined aluminum	• Laser • Flashlight	Micro windage and elevation	Integrated quick-detach rail mount	Quick-detach lever	2 x 3V-CR123A Included
TG7650R	Red	Satin black	Lightweight CNC-machined aluminum	• Laser / Flashlight	Micro windage and elevation	Integrated quick-detach rail mount	Quick-detach lever	2 x 3V-CR123A Included

WATER RESISTANT

SHOCK RESISTANT

RED LASER

GREEN LASER

2-YEAR LIMITED WARRANTY



# MICRO-TAC | TACTICAL MICRO LASER

30

WEAPON LASERS

## Laser / Light Modes

Constant Laser

Pulse Laser

Pulsing laser quickly draws the eye and extends battery life.

## Power Supply

TG988E (1.5V-AG4)

Batteries and spare batteries included. TG7650G requires 6 batteries, TG7650R requires 4 batteries. See page 34 for replacement batteries.



Now, even the smallest railed handguns can be outfitted with the brightest laser sights. Requiring only one rail slot and weighing-in just under one ounce, MICRO-TAC goes where you go—adding precise laser aiming to any weapon on the range, in your home, or even in your pocket.



Red Laser  
TG7630R



Green Laser  
TG7630G

## PRODUCT FEATURES

- Next generation, high-efficiency superconductor laser diode
- Pulse and constant laser modes
- Powerful 520nm green laser (TG7630G)
- Powerful 650nm red laser (TG7630R)
- Easy ambidextrous push-button activation for left and right-handed users
- Recessed ON / OFF buttons eliminate accidental activation
- Automatically shuts down after 5 minutes
- Mounts to standard Picatinny or Weaver-style rails
- Operating temperature: 14°F (-10°C) to 122°F (50°C)
- Weighs less than 1 oz.

## MODEL SPECS

MODEL	LASER COLOR	FINISH	CONSTRUCTION	MODES	ADJUSTMENTS	MOUNTING	BATTERY
TG7630G	Green	Anodized Matte Black	Lightweight CNC-machined aluminum	• Constant • Pulse	Windage and elevation	Integrated rail mount	1.5V-AG4 Included
TG7630R	Red						

WATER RESISTANT

SHOCK RESISTANT

RED LASER

GREEN LASER

2-YEAR LIMITED WARRANTY

TRUGLO TACTICAL 2017

COMPLETE YOUR

# SYSTEM

ACCESSORIES & TARGETS



WITH THE CRITICAL PIECES THAT

**HOLD EVERYTHING TOGETHER.**

# TAC-POD™

ADJUSTABLE FOLDING BIPODS

32

ACCESSORIES & TARGETS

## Includes

Picatinny rail sling stud adapter.



6-9"  
TG8902S

9-13"  
TG8902L

## PRODUCT FEATURES

- Mounts to sling swivel stud or picatinny rail
- Lightweight and compact with quick deployment
- Great for bench or prone shooting
- Spring-assisted design
- Included sling stud adapter can be used without bipod for additional sling mounting options
- Models TG8901L and TG8902L feature long legs to accommodate standard-capacity detachable magazines
- Padded rubberized feet
- Pivoting base for precision leveling on uneven surfaces
- Lever lock for quick tension adjustments or complete locking
- Durable construction for the harshest environments

## MODEL SPECS

MODEL	FINISH	CONSTRUCTION	BASE STYLE	MOUNTING	LENGTH
TG8901S	Satin Black	Lightweight all-metal construction with rubber feet	Fixed base	Sling swivel clamp or Picatinny rail mount (included)	6-9" (1/2" Increments)
TG8901L					9-13" (1/2" Increments)
TG8902S			Pivoting base		6-9" (1/2" Increments)
TG8902L					9-13" (1/2" Increments)

TRUGLO® TACTICAL 2017

UNIVERSAL FIT

ALL-METAL CONSTRUCTION

# TACTICAL SCOPE MOUNT

- Available in 1" or 30mm diameter
- Mounts to Picatinny rails
- CNC-machined construction
- Reversible one-piece base
- 4 bolts per ring for an extremely strong hold
- Integrated adjustable recoil lug
- Centerline is approximately 1.5" above mounting rail



TG8963B

MODEL	FINISH	LENGTH	HEIGHT	RING SIZE	MOUNTING
TG8963B	Anodized matte black	2 7/8" Base	1"	1"	Picatinny rail mount with recoil lug
TG8964B				30mm	

**NEW!**

# OFFSET PICATINNY MOUNT

- 45° Angled mount
- Mounts to standard Picatinny / 1913 / Weaver rails
- Angled mount provides fast transition to backup optic
- Ideal for mounting lights/ lasers without blocking optical sight
- CNC-Machined 6061-T6 Aluminum
- Slim design minimizes weight and bulk
- Mounts in any configuration: left or right side, top or bottom rail



TG8975B

MODEL	FINISH	LENGTH	ANGLE	MOUNTING
TG8975B	Anodized matte black	2"	45°	Picatinny rail mount with recoil lug

# PICATINNY RISER MOUNTS

- Mounts to existing Picatinny rail
- CNC-machined aluminum
- Easy to install without modification
- Ideal for mounting scopes or Red Dot sights
- Great for any AR-15 Flattop



TG8970B



TG8972B

MODEL	FINISH	STYLE	LENGTH	HEIGHT	MOUNTING
TG8970B	Anodized matte black	1-Piece	4"	1/2"	Picatinny rail mount with recoil lug
TG8980B				3/4"	
TG8990B				1"	
TG8972B		2-Piece	1.36"	1/2"	
TG8982B				3/4"	
TG8992B				1"	

# PICATINNY MOUNTING ADAPTER

- Converts 3/8" mounting bases into Picatinny or Weaver-style mounts
- Mounts to existing 3/8" rail
- CNC-machined aluminum
- Integrated adjustable recoil lug
- Easy to install without modification
- Accommodates all standard scope setups.

TG8953B



MODEL	FINISH	LENGTH	HEIGHT	MOUNTING
TG8953B	Anodized matte black	3.5"	5/8"	MOUNTING: 3/8" dovetail with recoil lug

# REPLACEMENT BATTERIES



We're proud of the battery life of our optics, but for those who value always being prepared, it never hurts to have a spare battery on hand.

MODEL	MODEL COMPATIBILITY
TG988C	For TRUGLO® Dot Optic Sights and Illuminated Scopes (2 per pack) (3V-CR2032, Lithium)
TG988E	For MICRO-TAC™ Tactical Micro-Laser (12 per pack) (1.5V-AG4, Silver Oxide)
TG988F	TRU•TEC™ 30mm Red Dots and TRU•POINT™ Laser / Light Combo (2 per pack) (3V-CR123A, Lithium)

## TRU•SEE™

### REACTIVE / SPLATTER TARGETS

#### Self-Adhesive Targets

stick to almost any surface. Adhesive repair dots cover holes and extend target life.

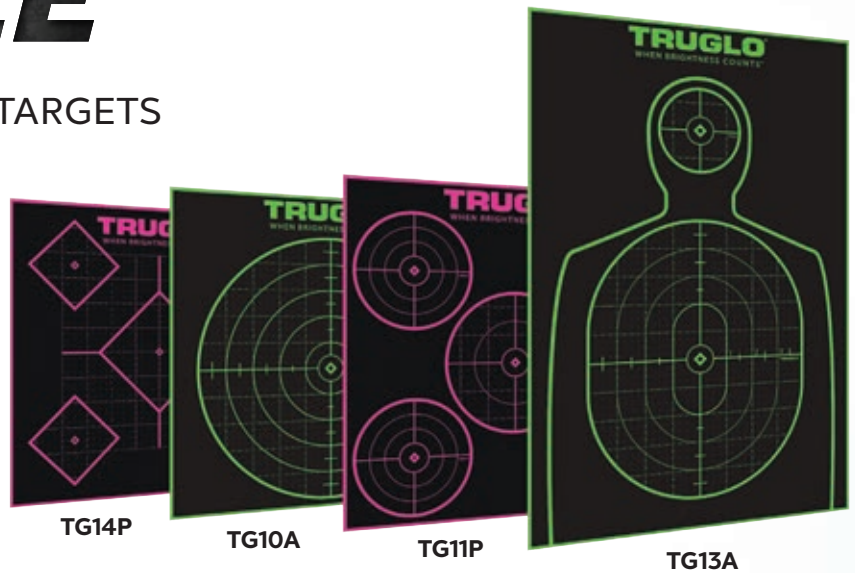

### PRODUCT FEATURES

- Ideal for all weapon types
- Point-of-impact visibility is enhanced by a fluorescent green or pink halo
- Flat finish with fluorescent green or pink background is easy to see downrange
- Shoot target as is or peel-and-stick the target to your favorite backstop
- Printed on heavy stock paper with a self-adhesive backing for increased target life

### MODEL SPECS

6-PACK	12-PACK	50-PACK	DESCRIPTION	COLOR
TG11A6	TG11A12	TG11A50	5-Bullseye	Green
TG11P6	-	-		Pink
TG14A6	TG14A12	TG14A50	5-Diamond	Green
TG14P6	-	-		Pink
TG13A6	TG13A12	TG13A50	Handgun	Green
TG13P6	-	-		Pink
TG10A6	TG10A12	TG10A50	100 Yard	Green

SELF-ADHESIVE BACKING

ACCU•GRID SIGHTING SYSTEM

EASY TO SEE

THE CHINISAL CHAARTS



EVERY DETAIL

**COUNTS.**



# DOT-OPTIC SPECS

MODEL	LENGTH (inches)	LENGTH WITH SUNSHADE (inches)	WEIGHT (ounces)	POWER / OBJECTIVE LENS	OPTIC HEIGHT (inches)	CO- WITNESS HEIGHT (inches)	FIELD OF VIEW (feet at 100yds)	EYE RELIEF (inches)	PARALLAX SETTING (in yards)	CLICK VALUE (Minutes of Angle)	RANGE OF ADJUSTMENT (inches at 100yds)	RETICLE COLOR	RETICLE TYPE	BATTERY	MOUNT
TG8135BN	5.24	—	10	1x 30mm	2.87	1.43		Unlimited	30	0.5	40	•	2-MOA Dot	CR2032	Cantilever rail mount included
TG8130BN	5.78	—	12.6	1x 30mm	2.25	1.43	68	Unlimited	30	0.5	40	•	2-MOA Dot	CR123A	Integrated rail mount
TG8130RN	5.78	—	12.9	1x 30mm	2.25	1.43	68	Unlimited	30	0.5	40	•	2-MOA Dot	CR123A	Integrated rail mount
TG8130GN	5.78	—	12.9	1x 30mm	2.25	1.43	68	Unlimited	30	0.5	40	•	2-MOA Dot	CR123A	Integrated rail mount
TG8120BN	2.4	—	4.91 (High mount) 4.0 (Low mount)	1x 20mm	2.30 (High mount) 1.38 (Low mount)	1.63 (High Mount) .71 (Low Mount)	46	Unlimited	30	0.5	40	•	2-MOA Dot	CR2032	High and low Mounting bases included
TG8120QN	2.4	—	4.91 (High mount) 4.0 (Low mount)	1x 20mm	2.30 (High mount) 1.38 (Low mount)	1.63 (High Mount) .71 (Low Mount)	46	Unlimited	30	0.5	40	•	2-MOA Dot	CR2032	High QD and low Mounting bases included
TG8230RB	5.2	—	11.3 with mount	1x 30mm	2.21	1.62	68	Unlimited	30	0.5	30	• • •	5-MOA Dot	CR2032	Cantilever rail mount included
TG8230TB /TBN	3.85	5.83	9.1	1x 30mm	1.61	1.02	68	Unlimited	30	1	30	• • •	3-MOA Center Dot	CR2032	Integrated rail mount
TG8030TB	3.82	5.83	8.1	1x 30mm	1.61	1	68	Unlimited	30	1	30	• • •	3-MOA Center Dot	CR2032	Integrated rail mount

# SCOPE SPECS

MODEL	DIMENSIONS							FIELD OF VIEW (feet @100 yards)		EYE RELIEF (inches @.75 diopter)		PARALLAX SETTING (yards)	CLICK VALUE (Minutes of Angle)	RANGE OF ADJUSTMENT (inches at 100yds)	RETICLE TYPE	BATTERY	MOUNT			
	A	B	C	D	E	F	G	WT. (ounces)	MAG.	OBJ. DIA. (mm)	HIGH POWER							LOW POWER	HIGH POWER	LOW POWER
TG8539TL	9.92	4.05	1.42	1.38	1.67	1.93	1.18	17.6	3-9x	42	12.1	28.8	3.81	4.3	100	0.25	30	IR Mil-Dot	CR2032	1-Piece rail mount included
TG8516TL	10.39	7.02	3.24	2.11	1.77	1.18	1.18	15.1	1-6x	24	18.15	103.71	4.7	4.7	100	0.5	50	IR Mil-Dot with power ring	CR2032	1-Piece rail mount included
TG8514BT	9.88	5.7	2.81	1.5	1.67	1.18	1.18	13.4	1-4x	24	23.03	92.6	3.15	3.7	50	0.5	50	Duplex Mil-Dot	-	1-Piece rail mount included
TG8504TL /TLN	9.8	3.8	1.6	1.06	1.67	1.46	1	15.4	4x	32	20.79		5.5		100	0.25	30	IR Mil-Dot	CR2032	Weaver- style Rings included
TG8504BT /BTN	9.8	3.8	1.6	1.06	1.46	1.46	1	12.5	4x	32	20.79		5.5		100	0.25	30	Mil-Dot	-	Weaver- style Rings included

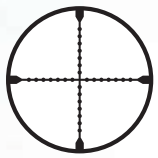

## MIL-DOT

Measure your target and calculate holdover or windage in milliradians. Dots spaced at 1-MIL increments across entire crosshair.

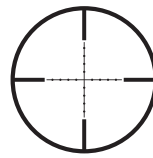

## DUPLEX MIL-DOT

Combines MIL-DOT measuring in the center of the reticle with a thick duplex-style crosshair for faster acquisition.



## POWER RING DUPLEX MIL-DOT

Combines MIL-DOT measuring in the center of the reticle with a thick duplex-style crosshair and illuminated Power Ring that combines the precision of a scope with the speed of a Red Dot.

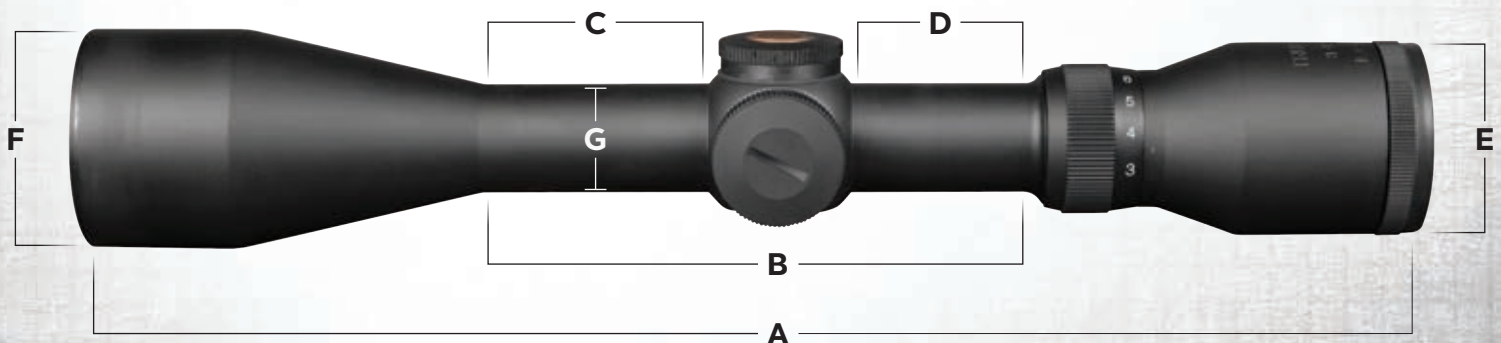



# HANDGUN SPECS

KEY FEATURES	MODELS							
	TFX™ PRO	TFX™		TFO®		FIBER-OPTIC	TRITIUM PRO	TRITIUM
		(Standard Height)	(Suppressor Height)	• • •	• • •			
<b>FIBER-OPTIC ILLUMINATION</b>	yes	yes	yes	yes	yes	yes	no	no
<b>TRITIUM ILLUMINATION</b>	yes	yes	yes	yes	yes	no	yes	yes
<b>SEALED TFX™ CAPSULE</b>	yes	yes	yes	no	no	no	no	no
<b>REAR SIGHT PROFILE</b>	Hooked	Smooth	Smooth	Smooth	Smooth	Smooth	Hooked	Smooth
<b>REAR SIGHT NOTCH</b>	U-notch	Square Notch	Square Notch	Square Notch	Square Notch	Square Notch	U-notch	Square Notch
<b>FOCUS-LOCK RING</b>	Orange	White	White	-	-	-	White	-
<b>HANDGUN MODELS</b>								
<b>BERETTA® PX4 STORM</b> (excluding Compact)	TG13BR1PC*	TG13BR1A*	-	-	-	-	TG231B1W	-
<b>CZ® 75 SERIES</b> (most models)	TG13CZ1PC	TG13CZ1A	-	-	-	-	-	-
<b>FNH® FNP-9, FNX-9 &amp; FNS-9</b> (including Compact)	TG13FN1PC	TG13FN1A	-	-	-	-	TG231F1W	-
<b>FNH® FNP-40, FNX-40 &amp; FNS-40</b> (including Compact)	TG13FN2PC	TG13FN2A	-	-	-	-	TG231F2W	-
<b>FNH® FNP-45, FNX-45</b>	TG13FN3PC	TG13FN3A	-	-	-	-	TG231F3W	-
<b>GLOCK® 17 / 17L, 19, 22, 23, 24, 26, 27, 33, 34, 35, 38, AND 39</b>	TG13GL1PC	TG13GL1A	TG13GL4A	TG13GT1	TG13GT1Y	TG13G1	TG231G1W	TG231G1
<b>GLOCK® 20, 21, 25, 29, 30, 31, 32, 37, 40, AND 41</b>	TG13GL2PC	TG13GL2A	TG13GL5A	TG13GT2	TG13GT2Y	TG13G3	TG231G2W	TG231G2
<b>GLOCK® 42, 43</b>	TG13GL3PC	TG13GL3A	-	TG13GT1A	TG13GT1B	TG13G3	TG231G1AW	TG231G1A
<b>GLOCK® MOS 17, 19, 34, AND 35</b>	-	-	-	-	-	-	TG231G1MW	-
<b>GLOCK® MOS 40 AND 41</b>	-	-	-	-	-	-	TG231G2MW	-
<b>H&amp;K® VP9, VP40, P30, P30SK, P30L, 45, &amp; 45 TACTICAL</b> (including Compact)	TG13HP1PC	TG13HP1A	-	-	-	-	TG231H1W	-
<b>KAHR ARMS® K, MK, P, PM, T &amp; TP MODELS WITH NEW DOVETAIL</b> (produced after 2004)	TG13KA1PC	TG13KA1A	-	TG131AT1	TG131AT1Y	-	TG231A1W	-
<b>KIMBER® 1911 MODELS WITH FIXED REAR SIGHT</b>	TG13KM1PC	TG13KM1A	-	TG131KT	TG131KT1Y	TG131K	TG231K1W	TG231K
<b>NOVAK® LOMOUNT CUT .260 FRONT / .450 REAR</b> (1911 5" Government .45ACP)**	TG13NV1PC	TG13NV1A	-	TG131NT1	TG131NT1Y	-	TG231N1W	TG231N1
<b>NOVAK® LOMOUNT CUT .270 FRONT / .450 REAR</b> (1911 5" Government 9mm / .40 S&W)**	TG13NV2PC	TG13NV2A	-	TG131NT2	TG131NT2Y	-	TG231N2W	TG231N2
<b>NOVAK® LOMOUNT CUT .260 FRONT / .500 REAR</b> (1911 3" Officers & 4.25" Commander .45ACP)**	TG13NV3PC	TG13NV3A	-	TG131NT3	TG131NT3Y	-	TG231N3W	TG231N3
<b>NOVAK® LOMOUNT CUT .270 FRONT / .500 REAR **</b> (1911 3" Officers & 4.25" Commander 9mm / .40S&W)*	TG13NV4PC	TG13NV4A	-	TG131NT4	TG131NT4Y	-	TG231N4W	TG231N4
<b>RUGER® SR9 / SR9C, SR40 / SR40C, SR45</b>	TG13RS1PC	TG13RS1A	-	TG131RT1*	-	-	TG231R1W	TG231R1
<b>RUGER® LC9 / 9S / 380</b>	TG13RS2PC	TG13RS2A	-	TG131RT2	TG131RT2Y	-	TG231R2W	TG231R2
<b>RUGER® AMERICAN 9MM AND 45</b>	TG13RS3PC	TG13RS3A	-	-	-	-	TG231R3W	-
<b>S&amp;W® M&amp;P</b> (including SHIELD & .22 models, excluding .22 Compact / C.O.R.E. models), <b>SD9 AND SD40</b> (excluding VE models)	TG13MP1PC	TG13MP1A	-	TG131MPT	TG131MPTY	TG131MP	TG231MP1W	TG231MP
<b>S&amp;W® BODYGUARD .380</b>	-	-	-	-	-	-	TG231MP2W	-
<b>SIG® #8 FRONT / #8 REAR SETS</b>	TG13SG1PC	TG13SG1A	-	TG131ST1	TG131ST1Y	TG131S1	TG231S1W	TG231S1
<b>SIG® #6 FRONT / #8 REAR SETS</b>	TG13SG2PC	TG13SG2A	-	TG131ST2	TG131ST2Y	TG131S2	TG231S2W	TG231S2
<b>SPRINGFIELD® XD, XDM</b> (excluding 5.25" Comp Series) <b>AND XDS</b>	TG13XD1PC	TG13XD1A	-	TG131XT	TG131XTY	TG131X	TG231X1W	TG231X
<b>STEYR® MANNLICHER M-A1, C-A1, S-A1, L-A1</b>	TG13SM1PC	TG13SM1A	-	-	-	-	-	-
<b>TAURUS® MILLENNIUM G2, 709 SLIM, 740 SLIM</b>	TG13TA2PC	TG13TA2A	-	-	-	-	TG231T2W	-
<b>WALTHER® P99 AND PPQ</b>	TG13WA1PC	TG13WA1A	-	-	-	-	TG231W1W	-
<b>WALTHER® PPS CLASSIC</b>	TG13WA2PC	TG13WA2A	-	-	-	-	TG231W2W	-
<b>WALTHER® PPS M2</b>	TG13WA4PC	TG13WA4A	-	-	-	-	-	-
<b>WALTHER® CCP</b>	TG13WA3PC	TG13WA3A	-	-	-	-	TG231W3W	-

\* Front sight only

\*\*Novak® LoMount cut replacement sights are designed for 1911-style handguns with existing fixed Novak® LoMount dovetail cut slides, however some fitting may be required. Installation by a competent gunsmith is recommended.

Due to gun manufacturers' machining tolerances, point-of-impact may differ slightly.



Accept no compromises, choose only quality hunting & shooting products.