

20
19
PRODUCT GUIDE



THE REAL #1

ANYONE CAN CLAIM IT. WE PROVE IT!

MADE IN



U.S.A.

APPAREL

- BANNERS..... 26
- DECALS..... 26
- OUTERWEAR..... 26
- SHIRTS..... 26
- NEW HOODIES..... 26
- NEW HATS & BEANIES..... 26

ACCESSORIES

- V-LOCK STRAPS..... 11
- REPLACEMENT STRAPS..... 27
- DRAWCHECK DEVICE..... 27
- T.R.U. BALL® ACCESSORIES..... 27
- AXCEL** TOURNAMENT ACCESSORIES..... 4-5
 - ACHIEVE XP ACCESSORIES..... 16-17
 - ACHIEVE ACCESSORIES..... 16-17
 - AX SERIES ACCESSORIES..... 16-17
 - SCOPE ACCESSORIES..... 19
 - AXCEL** HUNTING ACCESSORIES..... 20-23



TOURNAMENT

Signature Series

- ABYSS FLEX..... 14-15
- FULKUM FLEX..... 14-15
- NEW GOAT..... 14-15
- HBC..... 14-15
- TOURNAMENT WRIST STRAP RELEASES..... 6
 - EXECUTE..... 6
- TOURNAMENT BACK TENSION HANDLES..... 13
 - SWEET SPOT PRO..... 13
 - HT..... 13
 - NEW HT HYBRID FLEX..... 13
- TOURNAMENT TRIGGER HANDLES..... 12
 - BLADE PRO..... 12
 - BLADE..... 12
 - NEW RAVE..... 12
- AXCEL** TOURNAMENT SIGHTS AND SCOPES..... 4-5
 - NEW ACHIEVE XP..... 4-5
 - AX SERIES SIGHTS..... 16
 - ACHIEVE SIGHTS..... 17
 - ACCVIEW TOURNAMENT SCOPES..... 18-19
 - CURVE TOURNAMENT SCOPES..... 18-19
 - CURVE RECURVE SCOPE..... 18-19
 - S SCOPE..... 18-19
 - SJEF SIGNATURE SCOPE..... 18-19

HUNTING

HUNTING WRIST STRAP RELEASES..... 6

- SHORT-N-SWEET R..... 6
- NEW BEAST XT..... 7
- NEW ASSASSIN XT..... 7
- COPPERHEAD TC..... 7
- NEW COPPERHEAD..... 7
- BONE COLLECTOR** SERIES..... 8
- 2019 POWER BUYS..... 9
 - STINGER..... 9
 - SHOOTER..... 9
 - ASSASSIN..... 9
 - BANDIT..... 9
- FANG SERIES... (HANDLES AND WRIST STRAPS)..... 10
- HUNTING HANDLES..... 11
 - NEW MAX+ HUNTING SERIES..... 11
 - CHAMP..... 11
- AXCEL** HUNTING SIGHTS..... 20
 - ACCUTOUCH HUNTING SIGHTS..... 20
 - SINGLE PIN SIGHTS..... 20
 - MULTI-PIN SIGHTS..... 21
 - ARMORTECH SIGHTS..... 22
 - ARMORTECH VISION SIGHTS..... 23
 - RHEOTECH SIGHTS..... 24
 - ACCUHUNTER SIGHTS..... 25
- AXCEL** HUNTING SCOPES..... 21
 - ACCUSTAT SCOPES..... 21
 - AV HUNTER SCOPE..... 25

NEW PRODUCTS 2019



- A. T.R.U. BALL® DIRTY TRUCKER HAT - PAGE 26
- B. AXCEL® HOODIE - PAGE 26
- C. T.R.U. BALL® HT HYBRID FLEX (ALUMINUM INSERT INSTALLED) - PAGE 13
- D. T.R.U. BALL® GOAT - PAGE 15
- E. T.R.U. BALL® HT HYBRID FLEX (BRASS INSERT INSTALLED) - PAGE 13
- F. T.R.U. BALL® HOODIE - PAGE 26
- G. AXCEL® DIRTY TRUCKER HAT - PAGE 26
- H. T.R.U. BALL® MAX PRO CAMO+ - PAGE 11
- I. AXCEL® ACHIEVE XP RECURVE LH - PAGE 5
- J. AXCEL® ACHIEVE XP COMPOUND RH - PAGE 4
- K. AXCEL® ACHIEVE XP COMPOUND RH - PAGE 4
- L. AXCEL® ACHIEVE XP RECURVE RH - PAGE 5
- M. T.R.U. BALL® RAVE - PAGE 12
- N. T.R.U. BALL® MAX HUNTER + - PAGE 11
- O. T.R.U. BALL® MAX PRO+ - PAGE 11
- P. T.R.U. BALL® ASSASSIN XT (BUCKLE STRAP) - PAGE 7
- Q. T.R.U. BALL® BEAST XT - PAGE 7
- R. T.R.U. BALL® GOAT - PAGE 15
- S. T.R.U. BALL® ASSASSIN XT (VELCRO® STRAP) - PAGE 7
- T. T.R.U. BALL® COPPERHEAD - PAGE 7

DOMINATING THE MAJORS

NEW PRODUCTS 2019

ACHIEVE
XPB

PAGE 4-5



CHRIS PERKINS
VEGAS CHAMPION

CANADA | MENS COMPOUND

BERST
XT

PAGE 7



ALEXIS RUIZ
VEGAS CHAMPION

UNITED STATES | WOMENS COMPOUND

ASSASSIN
XT

PAGE 7



SARA LOPEZ
WORLD CUP FINAL CHAMPION

COLOMBIA | WOMENS COMPOUND

COPPERHEAD

PAGE 7



KIM WOOJIN
WORLD CUP FINAL CHAMPION

SOUTH KOREA | MENS RECURVE

MAX+ HUNTING SERIES

PAGE 11



MACKENZIE BROWN
U.S. NATIONAL CHAMPION

UNITED STATES | WOMENS RECURVE

RNVE

PAGE 12



DAN MCCARTHY
IBO WORLD CHAMPION

UNITED STATES | MENS COMPOUND

HYBRID
FLUX

PAGE 13

THE GOAT
A HUNTER AND ARCHER'S BEST FRIEND

PAGE 15

THE REAL #1

ANYONE CAN CLAIM IT. WE PROVE IT!

**NEW
2019**

COMPOUND

ACHIEVE XP

XTRA PERFORMANCE

DESIGNED FOR THE TOP ARCHERS IN THE WORLD

NEW PATENT PENDING WEDGE LOCK
PROVIDES WIDER CONTACT THAN A SCREW TIP FOR THE STRONGEST HOLD IN THE MARKETPLACE

XP

ELEVATION
20 CLICKS PER REVOLUTION

WINDAGE
20 CLICKS PER REVOLUTION

TRAVEL
0.00156"

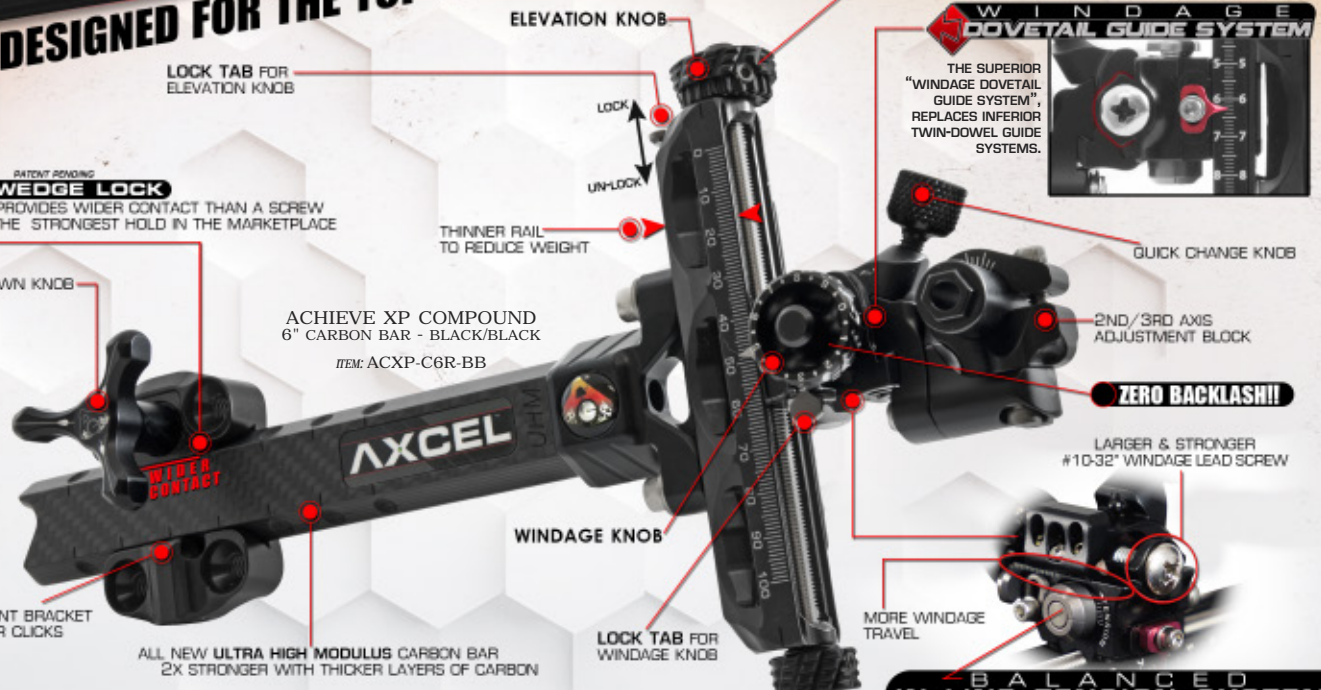

ACHIEVE XP COMPOUND
6" CARBON BAR - BLACK/BLACK
ITEM: ACXP-C6R-BB

WEDGE LOCK BOW MOUNT BRACKET WITH EXTENSION LOCATOR CLICKS

ALL NEW ULTRA HIGH MODULUS CARBON BAR 2X STRONGER WITH THICKER LAYERS OF CARBON

XP

XTRA PERFORMANCE COMPOUND FEATURES

- NEW ULTRA HIGH MODULUS CARBON BAR, 2X STRONGER, CONTAINS THICKER LAYERS OF CARBON
- NEW WEDGE LOCK BOW MOUNT BRACKET IS HANDS DOWN STRONGER THAN ANY OTHER PATENT PENDING
- IN-LINE TENSION ADJUSTMENT ALLOWS THE SIGHT PIN TO STAY ON TARGET FROM SHOT TO SHOT
- STRONGER 10-32 WINDAGE LEAD SCREW
- ENLARGED DIAMETER WINDAGE AND ELEVATION KNOBS WITH CLICK LOCKS
- THINNER, WEIGHT-REDUCING ELEVATION RAIL
- METAL SIGHT TAPE OPTION FOR COMPOUND MODELS ONLY (8 INCLUDED, 20 SOLD SEPARATELY) SEE BELOW
- ULTRA HIGH MODULUS 6" & 9" BAR AVAILABLE FOR COMPOUND SIGHTS

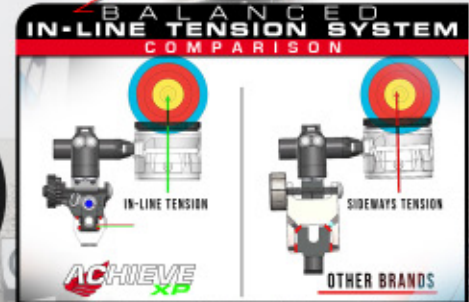

AXCEL ACHIEVE XP SIGHTS | AVAILABLE COLORS

COLOR OPTIONS

COLORS MAY VARY FROM PICTURES

- A. BB - (BLACK / BLACK)
- B. SB - (SILVER / BLACK)
- C. LB - (BLUE / BLACK)
- D. RB - (RED / BLACK)
- E. GB - (GOLD / BLACK)
- F. UB - (PURPLE / BLACK)
- G. EB - (GREEN / BLACK)
- H. OB - (ORANGE / BLACK)



NEW METAL SIGHT TAPES

COMPOUND ACCESSORY METAL SIGHT TAPES

INCLUDED WITH SIGHT:
SIGHT TAPE #

| | | | |
|------|-------|-------|-------|
| 5-6 | 13-14 | 21-22 | 29-30 |
| 9-10 | 17-18 | 25-26 | 33-34 |

AVAILABLE SEPARATELY:
SIGHT TAPE #

| | | | |
|-----|-------|-------|-------|
| 1-2 | 11-12 | 23-24 | 35-36 |
| 3-4 | 15-16 | 27-28 | 37-38 |
| 7-8 | 19-20 | 31-32 | 39-40 |

ITEM: ACXP-MST-_-_-
EXAMPLE ITEM: ACXP-MST-35-36

TOP FEATURE FOR COMPOUND

ACCESSORIES

COMPOUND AND RECURVE ACCESSORY ULTRA HIGH MODULUS CARBON EXTENSION BARS

- ACXP-UEx-6R UHM CARBON EXTENSION BAR - 6", RIGHT HAND (COMPOUND ONLY)
- ACXP-UEx-6L UHM CARBON EXTENSION BAR - 6", LEFT HAND (COMPOUND ONLY)
- ACXP-UEx-9R UHM CARBON EXTENSION BAR - 9", RIGHT HAND
- ACXP-UEx-9L UHM CARBON EXTENSION BAR - 9", LEFT HAND



4 NEW ACHIEVE XP

**NEW
2019**

R E C U R V E

ACHIEVE XP

XTRA PERFORMANCE



XTRA PERFORMANCE RECURVE FEATURES

- NEW ULTRA HIGH MODULUS CARBON BAR, 2X STRONGER, CONTAINS THICKER LAYERS OF CARBON
- NEW WEDGE LOCK BOW MOUNT BRACKET IS HANDS DOWN STRONGER THAN ANY OTHER PATENT PENDING
- IN-LINE TENSION ADJUSTMENT ALLOWS THE SIGHT PIN TO STAY ON TARGET FROM SHOT TO SHOT
- STRONGER 10-32 WINDAGE LEAD SCREW
- ENLARGED DIAMETER WINDAGE AND ELEVATION KNOBS WITH CLICK LOCKS
- THINNER, WEIGHT-REDUCING ELEVATION RAIL
- NEW SLEEVE LOCK APERTURE BLOCK (INCLUDED WITH ALL RECURVE MODELS)
- SIGHT PIN ALIGNMENT BLOCK (SOLD SEPARATELY FOR RECURVE MODELS)
- ULTRA HIGH MODULUS 9" BAR FOR RECURVE SIGHTS

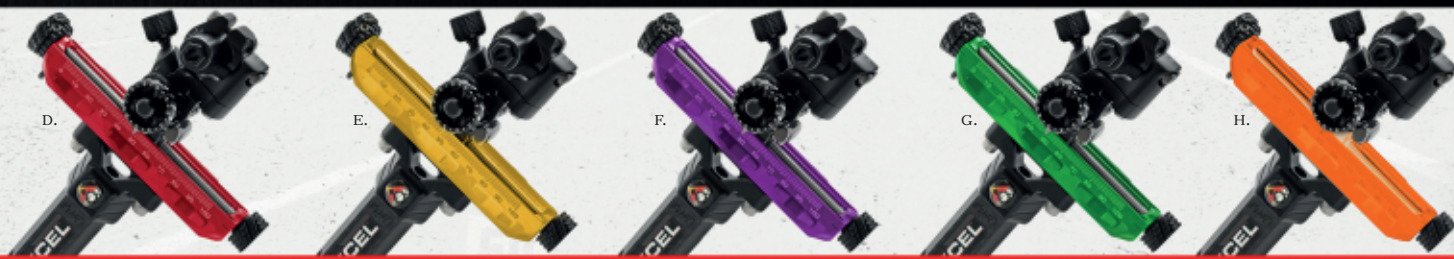

MORE AXCEL TARGET ACCESSORIES AVAILABLE ON PAGE 16-17

COMPOUND AND RECURVE ACCESSORY WEDGE LOCK BOW MOUNT BRACKETS

PATENT PENDING

ITEM: ACXP-WLMB + COLOR CHOICE



RECURVE ACCESSORY SIGHT PIN ALIGNMENT BLOCK

NEW FOR RECURVE SIGHTS!
ALIGN SCOPE TO YOUR EYE

NO SHIMS NEEDED
BETWEEN BOW AND SIGHT

ITEM: ACXP-RAB

**TOP FEATURE FOR
RECURVE**



NEW ACHIEVE XP 5

short-n-sweet'R

STRAP OPTIONS:
 * BLACK LEATHER BUCKLE OR CAMO VELCRO® STRAP

USAGE:
 HUNTING

THE EVER-POPULAR SHORT-N-SWEET GOT SHORT-N-SWEET'R! THE SHORT-N-SWEET'R'S LIGHTER AND SMALLER, TUBULAR-SHAPED BODY ALLOWS LESS OBSTRUCTION IN YOUR HAND AND MAKES IT EASY TO TUCK INTO YOUR SLEEVE WHILE NOT IN USE. THIS SHORT-N-SWEET'R RELEASE CONTAINS THE SAME FEATHER-LIGHT, NON-COLLAPSING TRIGGER THAT WAS POPULAR WITH THE SHORT-N-SWEET AND A SINGLE TRAVEL SCREW FOR ADJUSTING THE FEEL OF TRIGGER PRESSURE TO CUSTOMIZED, INDIVIDUAL PREFERENCES. THE QUICK-LOADING, OPEN-HOOK DESIGN ALLOWS THE HUNTER A SPEEDY AND SECURE CONNECTION TO THE STRING LOOP WITHOUT NEEDING TO TAKE EYES OFF OF THE PRIZED GAME. THE SHORT-N-SWEET'R WILL ALSO COME STANDARD WITH THE CINCH STRAP: A MICRO-ADJUSTABLE WEB STRAP THAT CONTAINS A SINGLE SOCKET HEAD CAP SCREW THAT IS LOOSENED TO MAKE AN ADJUSTMENT FOR INFINITE DRAW LENGTH SETTINGS, AND THEN TIGHTENED TO LOCK THE WEBBING IN THE DESIRED POSITION. THE SHORT-N-SWEET'R IS AVAILABLE WITH A BLACK ANODIZED HEAD AND YOUR CHOICE OF THE VELCRO® OR BUCKLE CINCH STRAP IN JUNIOR, LARGE, OR X-LARGE SIZES. "KEEP YOUR EYE ON THE PRIZE"

FEATURING
CINCH
 TECHNOLOGY

ITEM: SR1B - SHORT-N-SWEET'R S1
 - BLACK LEATHER BUCKLE STRAP

ITEM: SR1V - SHORT-N-SWEET'R S1
 - CAMO VELCRO® STRAP

STRAIGHT FORWARD TRIGGER! **↑SPEED**
 HIGH-SPEED

ITEM: SR2B - SHORT-N-SWEET'R S2
 - BLACK LEATHER BUCKLE STRAP

ITEM: SR2V - SHORT-N-SWEET'R S2
 - CAMO VELCRO® STRAP

SWEPT BACK TRIGGER! **COMFORT**
 COMFORT-PLUS

USAGE!
 TOURNAMENT

CONNECTION OPTIONS:
 * TORNADO CONNECTION (TC) OR CINCH STRAP
 STRAP OPTIONS:
 - BLACK LEATHER BUCKLE OR CAMO VELCRO® STRAP

EXECUTE

FIELD TESTED, PROFESSIONAL APPROVED!

- NICKEL PLATED BRASS HEAD GIVES WEIGHT, CONTRIBUTES TO CRISPER RELEASE
- INDEPENDENT TRAVEL AND SENSITIVITY ADJUSTMENTS WITH LOCK SCREWS
- CRISP DOUBLE SEAR INTERNAL FIRING MECHANISM
- KNURLED COCKING BAR
- TWO INTERCHANGEABLE KNURLED TRIGGERS (FORWARD/RELAXED)
- TORNADO CONNECTION (TC) AND CINCH STRAP CONNECTIONS AVAILABLE
- HARDENED STAINLESS STEEL INTERNAL FIRING MECHANISM
- EACH TRIGGER IS ADJUSTABLE FOR A PERSONALIZED FIT

QS FEATURING
 QUICKSILVER FINISH
 CORROSION RESISTANT ELECTROLESS
 BRUSHED NICKEL PLATED BRASS

ITEM: TXTB-NB-L - EXECUTE TC
 TORNADO CONNECTION - BLACK LEATHER BUCKLE STRAP

ITEM: TXWB-NB-L - EXECUTE
 CINCH CONNECTION - BLACK LEATHER BUCKLE STRAP

ITEM: TXWV-NB-L - EXECUTE
 CINCH CONNECTION - CAMO VELCRO® STRAP

EXECUTE
 TC

TORNADO CONNECTION (TC)



EXECUTE
 with CINCH STRAP

FEATURING
CINCH
 TECHNOLOGY

OUR CINCH STRAP CONNECTION IS THE QUICKEST AND EASIEST WAY TO MICRO-ADJUST YOUR FAVORITE TOP QUALITY WEB STRAP T.R.U. BALL® RELEASES. START BY LOOSENING THE SOCKET HEAD CAP SCREW IN THE TOP OF THE CINCH CONNECTOR, MOVE THE WEB STRAP IN OR OUT, AND RE-TIGHTEN THE SCREW. IT COULDN'T BE EASIER OR MORE ACCURATE, PROVING ONCE AGAIN THAT T.R.U. BALL® RELEASES ARE THE BEST FOR HUNTERS AND TARGET ARCHERS!!!

NEW 2019 BEAST XT

RELEASE OPTIONS:
 - BEAST XT 1 - STRAIGHT FORWARD TRIGGER OR BEAST XT 2 - SWEEP BACK TRIGGER
 STRAP OPTIONS:
 - BLACK LEATHER BUCKLE OR CAMO VELCRO® STRAP



ERGONOMIC NEW IN-LINE BODY STYLE
 FEATHER-LIGHT, NON-COLLAPSING TRIGGER
 SINGLE TRAVEL ADJUSTMENT SCREW FOR FINE TUNING
 OPEN HOOK DESIGN ALLOWS ARCHERS TO KEEP THEIR EYE ON THE PRIZE

- ITEM: BX1B - BEAST XT 1
 - BLACK LEATHER BUCKLE STRAP
- ITEM: BX1V - BEAST XT 1
 - CAMO VELCRO® STRAP
- ITEM: BX2B - BEAST XT 2
 - BLACK LEATHER BUCKLE STRAP
- ITEM: BX2V - BEAST XT 2
 - CAMO VELCRO® STRAP



NEW 2019 ASSASSIN XT

STRAP OPTIONS:
 - BLACK LEATHER BUCKLE OR CAMO VELCRO® STRAP

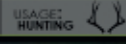

FULLY INDEPENDENT DUAL CALIPER JAWS
 NEW BODY DESIGN WITH ADDED TEXTURE
 GLOBO-SWIVEL CONNECTION TO STRAP WITH 5 HOLE ADJUSTMENT CONNECTOR
 SINGLE TRAVEL ADJUSTMENT SCREW FOR FINE TUNING
 PULL THE TRIGGER TO OPEN, LET UP TO CLOSE

- ITEM: TAXB - ASSASSIN XT
 - BLACK LEATHER BUCKLE STRAP
- ITEM: TAXV - ASSASSIN XT
 - CAMO VELCRO® STRAP



COPPERHEAD



BACK BY POPULAR DEMAND, THE T.R.U. BALL® COPPERHEAD AND COPPERHEAD TC FEATURE FULLY-INDEPENDENT DUAL CALIPER JAWS AND A SMALL HALF-INCH DIAMETER HOUSING, DELIVERING SUPERIOR QUALITY THAT CONSUMERS HAVE COME TO EXPECT FROM A T.R.U. BALL® RELEASE. THE COPPERHEAD FEATURES A WEB STRAP, ALLOWING THE HEAD TO BE SNATCHED UP WITH THE TRIGGER RIGHT NEXT TO THE TRIGGER FINGER, READY TO BE FIRED AT A MOMENT'S NOTICE. THE COPPERHEAD TC FEATURES OUR LEGENDARY TORNADO CONNECTION AT THE WRIST STRAP THAT ALLOWS 360 DEGREE, MULTI-DIRECTIONAL MOVEMENT, WHILE AN ADDITIONAL 360 DEGREE SWIVEL DIRECTLY BEHIND THE TRIGGER TWISTS THE HEAD OF THE RELEASE INTO A LOW TORQUE LOCATION ON EACH AND EVERY SHOT. THE CONNECTOR ADAPTS THE LENGTH OF THE COPPERHEAD TC IN PRECISE 3/16" INCREMENTS TO FIT A WIDE RANGE OF DRAW LENGTHS. TUCK BOTH VERSIONS OF THE COPPERHEAD INTO YOUR SLEEVE WHEN NOT IN USE FOR WALKING THROUGH THE WOODS OR EASE OF CLIMBING THE TREE STAND LADDER WITHOUT HANG-UPS. A SINGLE TRAVEL SCREW FOR ADJUSTING THE FEEL OF TRIGGER PRESSURE IS SECURED WITH A LOCK SCREW FOR MAINTAINING RELIABLE SETTINGS. THE COPPERHEAD COMES WITH A COPPER COLORED AIRCRAFT ALUMINUM ANODIZED HEAD IN A LARGE, BLACK BUCKLE WRIST STRAP.

AVAILABLE IN LARGE BUCKLE ONLY

COPPERHEAD TC

- ITEM: TCTB-CU-L
 - COPPERHEAD TC
 - TORNADO CONNECTION
 - BLACK LEATHER BUCKLE STRAP
 - LARGE



TORNADO CONNECTION (TC)

NEW 2019 COPPERHEAD

- ITEM: TCWB-CU-L
 - COPPERHEAD
 - CINCH CONNECTION WEB-STRAP
 - BLACK LEATHER BUCKLE STRAP
 - LARGE



WEB STRAP CONNECTION

FEATURING
CINCH
 TECHNOLOGY

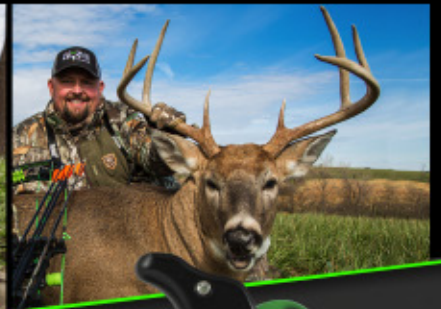

BONE COLLECTOR™ T-REX

USAGE:
HUNTING 

ITEM: TTR4-BK
- BONE COLLECTOR™ T-REX - 4 FINGER - BLACK
- WITH LANYARD



SUPERIOR FEATURES

- ULTRA-QUIET
- TRIGGER ADJUSTABLE LIGHT TO HEAVY
- EASY TO LOAD / PINCH JAW ONTO D-LOOP TO LOAD
- BUILT-IN LANYARD
- COMFORTABLE 4 FINGER HANDLE
(SAME AS BLADE 4 MEDIUM)
- INDIVIDUAL TRAVEL AND SENSITIVITY ADJUSTMENT SCREWS WITH LOCKS
- MULTI-POSITIONAL THUMB BARREL AND TEARDROP

T.R.U. BALL® BONE COLLECTOR™ WRIST STRAP RELEASES

STRAP OPTIONS:
- BLACK LEATHER BUCKLE OR BLACK VELCRO® STRAP

USAGE:
HUNTING 

RELEASE THE BEAST

DESIGNED ESPECIALLY FOR MICHAEL WADDELL & THE BONE COLLECTOR™ TEAM, T.R.U. BALL'S ENGINEERS HAVE ADDED A SOLID ROD CONNECTION & A 30Z OR 110Z SPRING CHOICE TO THEIR FAVORITE RELEASE, THE T.R.U. BALL® SHORT-N-SWEET. THE BEAST IS THE ADVANCED "HIGH-SPEED" MODEL WITH A FORWARD TRIGGER TO PROVIDE MORE DRAW LENGTH FOR SHORT DRAW ARCHERS. THE BEAST II IS THE "COMFORT-PLUS" MODEL WITH A RELAXED TRIGGER, SWEEP BACK TO PROVIDE ARCHERS THE ULTIMATE FEEL WHEN MAKING THE SHOT. QUICK LOAD OPEN HOOK DESIGN ALLOWS A HUNTER TO HOOK THE STRING LOOP WITHOUT TAKING EYES OFF THE GAME. ALSO INCLUDES THE DROP-AWAY SOLID ROD GLOBE-SWIVEL CONNECTION WITH DRAW LENGTH ADJUSTMENT. AVAILABLE WITH BLACK LEATHER BUCKLE STRAP OR BLACK VELCRO® STRAP. JUST PULL THE TRIGGER & LET UP TO RE-SET, THEN YOU ARE READY TO DRAW & SHOOT.

ITEM: BC1B
- THE BEAST - BLACK LEATHER BUCKLE STRAP

ITEM: BC1V
- THE BEAST - BLACK VELCRO® STRAP

ITEM: BC2B
- THE BEAST II - BLACK LEATHER BUCKLE STRAP

ITEM: BC2V
- THE BEAST II - BLACK VELCRO® STRAP

BONE COLLECTOR™ BEAST



BONE COLLECTOR™ ASSASSIN

T.R.U., INC. HAS CHOSEN THIS VERSION OF OUR BEST BUY-WINNING ASSASSIN, TO WEAR THE BANNER LOGO OF THE FAMED BONE COLLECTOR™, MAKING THIS BONE COLLECTOR™ ASSASSIN THE TOP-OF-THE-LINE DUAL CALIPER RELEASE AVAILABLE TODAY! THIS RELEASE BLENDS A 6061 AIRCRAFT ALUMINUM BODY WITH TOUGH TRIGGER AND JAWS, TO PROVIDE THE CRISPEST RELEASE WITH LONG-LASTING RELIABILITY! AVAILABLE IN A BLACK ANODIZED HEAD WITH YOUR CHOICE OF A BLACK VELCRO® STRAP OR A BLACK LEATHER BUCKLE STRAP.

ITEM: TASB - BONE COLLECTOR™ ASSASSIN
- BLACK LEATHER BUCKLE STRAP

ITEM: TASV - BONE COLLECTOR™ ASSASSIN
- BLACK VELCRO® STRAP



BONE COLLECTOR™ BANDIT

THE BONE COLLECTOR™ BANDIT FEATURES A ROPE CONNECTION COVERED IN WEATHER RESISTANT FLEXIBLE TUBING, DESIGNED TO MAKE YOUR RELEASE READY IN HUNTING SITUATIONS WHERE SPEED IS KEY. HAS A GREEN ROPE CONNECTION SYSTEM TO PROVIDE EASY ADJUSTMENT FOR ANY ANCHOR POINT. PULL TRIGGER TO OPEN FULLY-INDEPENDENT STANDARD CALIPER JAWS, AND LET UP THE TRIGGER TO CLOSE. AVAILABLE WITH BLACK HEAD IN YOUR CHOICE OF BLACK LEATHER BUCKLE STRAP OR BLACK VELCRO® STRAP.

ITEM: BCBB
- BONE COLLECTOR™ BANDIT
- BLACK LEATHER BUCKLE STRAP

ITEM: BCBV
- BONE COLLECTOR™ BANDIT
- BLACK VELCRO® STRAP



BONE COLLECTOR™ SCOUT

THE BONE COLLECTOR™ SCOUT IS FOR THOSE ARCHERS AND BOWHUNTERS WHO WANT THEIR RELEASE TO BE OUT OF THE WAY UNTIL IT IS NEEDED. DESIGNED FROM THE BEST BUY-WINNING ASSASSIN CALIPER HEAD, THE BONE COLLECTOR™ SCOUT FEATURES A WEB STRAP WITH A TWO SLOT CONNECTOR THAT ALLOWS FOR SHORT AND LONG FINGER LENGTHS ALIKE. PULL TRIGGER TO OPEN FULLY-INDEPENDENT STANDARD CALIPER JAWS, AND LET UP THE TRIGGER TO CLOSE. AVAILABLE WITH A BLACK HEAD AND YOUR CHOICE OF BLACK VELCRO® STRAP OR BLACK LEATHER BUCKLE STRAP.

ITEM: BCBSB
- BONE COLLECTOR™ SCOUT
- BLACK LEATHER BUCKLE STRAP

ITEM: BCBSV
- BONE COLLECTOR™ SCOUT
- BLACK VELCRO® STRAP



GREEN ROPE CONNECTOR

- QUICK AND EASY ADJUSTMENT FOR ANY ANCHOR POINT
- LESS TORQUE, GREATER ACCURACY
 - ADJUST VERY SHORT OR VERY LONG
 - TUCKS AWAY EASILY IN SLEEVE

BONE COLLECTOR IS A REGISTERED TRADEMARK OF MICHAEL WADDELL LLC. THE T-REX, THE BONE COLLECTOR™ BEAST, THE BONE COLLECTOR™ BEAST II, THE BONE COLLECTOR™ BANDIT, THE BONE COLLECTOR™ SCOUT, AND THE BONE COLLECTOR™ ASSASSIN ARE OFFICIAL LICENSED PRODUCTS OF MICHAEL WADDELL'S BONE COLLECTOR™.

STINGER

USAGE: HUNTING 

COLOR OPTIONS:
 • BLACK (BK) OR CAMO (CA)
 STRAP OPTIONS:
 • BLACK LEATHER BUCKLE OR CAMO VELCRO® STRAP

PULL TRIGGER TO OPEN, LET UP TO CLOSE! RIGID ROD KEEPS THE 1/2" SIZED ERGONOMIC HEAD CLOSE AND READY. THE NUMBER 1 SELLING T.R.U. BALL® RELEASE! AVAILABLE WITH BLACK OR CAMO ANODIZED HEAD AND YOUR CHOICE OF BLACK LEATHER BUCKLE STRAP OR CAMO VELCRO® STRAP.

ITEM: TSBR - STINGER
 - BLACK LEATHER BUCKLE STRAP

ITEM: TSTR - STINGER
 - CAMO VELCRO® STRAP

ITEM: TSBR-CA - CAMO STINGER
 - BLACK LEATHER BUCKLE STRAP

ITEM: TSTR-CA - CAMO STINGER
 - CAMO VELCRO® STRAP



#1 SELLING T.R.U. BALL® RELEASE!

SHOOTER

PERFECT FOR SMALLER HANDS!

DESIGNED FOR SHOOTERS WITH SMALL WRISTS, BUT ALSO AVAILABLE IN LARGE SIZES, THE SHOOTER SERIES FEATURES FOUR BRIGHT COLOR COMBINATIONS OF RED WHITE AND BLUE, GREEN AND BLACK, RED AND GOLD, AND PURPLE AND GOLD. PULL TRIGGER TO OPEN FULLY-INDEPENDENT STANDARD CALIPER JAWS, AND LET UP THE TRIGGER TO CLOSE. THE SHOOTER HAS A RED ROPE CONNECTION SYSTEM TO PROVIDE EASY ADJUSTMENT FOR ANY ANCHOR POINT. THE ROPE STYLE CONNECTION BETWEEN THE HEAD AND STRAP ALLOWS FOR LESS TORQUE AND GREATER ACCURACY, WHILE ALSO ALLOWING THE LENGTH OF THE RELEASE TO BE EXTREMELY SHORT TO FIT SMALLER HANDS. TUCKS AWAY EASY INTO SLEEVE WHEN NOT IN USE. AVAILABLE IN JUNIOR OR LARGE WITH CHOICE OF BLACK VELCRO® STRAP OR BLACK LEATHER BUCKLE STRAP.

ITEM: TOOB - SHOOTER - BLACK LEATHER BUCKLE STRAP
 ITEM: TOOV - SHOOTER - BLACK VELCRO® STRAP

AVAILABLE COLORS



BLUE (BL)

COLOR OPTIONS:
 • BLUE (BL), RED (RD), GREEN (GR), OR PURPLE (PR)
 STRAP OPTIONS:
 • BLACK LEATHER BUCKLE OR BLACK VELCRO® STRAP

USAGE: HUNTING 

RED ROPE CONNECTOR

QUICK AND EASY ADJUSTMENT FOR ANY ANCHOR POINT
 - LESS TORQUE, GREATER ACCURACY
 - ADJUST VERY SHORT OR VERY LONG
 - TUCKS AWAY EASILY IN SLEEVE

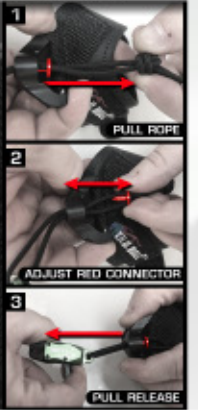

2 0 1 9

POWER BUYS

MOST POPULAR, BEST VALUE RELEASES FOR 2019

ASSASSIN

USAGE: HUNTING 

STRAP OPTIONS:
 • BLACK LEATHER BUCKLE OR CAMO VELCRO® STRAP

DEADLY SILENT & ACCURATE, THIS SMALL SIZE CALIPER RELEASE FROM T.R.U. BALL® INCLUDES THE DROP-AWAY SOLID ROD GLOBE-SWIVEL CONNECTION WITH 5 EASY AND SPECIFIC DRAW LENGTH ADJUSTMENT LOCATIONS USING TWO SCREWS AVAILABLE WITH A BLACK ANODIZED HEAD WITH YOUR CHOICE OF CAMO VELCRO® STRAP OR BLACK LEATHER BUCKLE STRAP.

ITEM: TANB-BK - ASSASSIN
 - BLACK LEATHER BUCKLE STRAP

ITEM: TANV-BK - ASSASSIN
 - CAMO VELCRO® STRAP



HOT - MUST HAVES 9

BANDIT

STRAP OPTIONS:
 • BLACK LEATHER BUCKLE OR CAMO VELCRO® STRAP

USAGE: HUNTING 

THE BANDIT FEATURES A ROPE CONNECTION COVERED IN WEATHER RESISTANT FLEXIBLE TUBING, DESIGNED TO MAKE YOUR RELEASE READY IN HUNTING SITUATIONS WHERE SPEED IS KEY. HAS A RED ROPE CONNECTION SYSTEM TO PROVIDE EASY ADJUSTMENT FOR ANY DRAW LENGTH. AVAILABLE WITH BLACK ANODIZED HEAD IN YOUR CHOICE OF BLACK LEATHER BUCKLE STRAP OR CAMO VELCRO® STRAP.

ITEM: TBDB - BANDIT - BLACK LEATHER BUCKLE STRAP

ITEM: TBDV - BANDIT - CAMO VELCRO® STRAP

RED ROPE CONNECTOR

QUICK AND EASY ADJUSTMENT FOR ANY ANCHOR POINT
 - LESS TORQUE, GREATER ACCURACY
 - ADJUST VERY SHORT OR VERY LONG
 - TUCKS AWAY EASILY IN SLEEVE



FANG WRIST STRAP MODELS

USAGE: HUNTING 

THE FANG SERIES OF WRIST STRAP MODELS INCLUDE THE FANG, FANG RC AND FANG GS. THE FANG SERIES IS A SUPERIOR ERGONOMIC HOOK STYLE RELEASE, FEATURING A RUBBER INSERT IN THE TRIGGER FOR IMPROVED FEEL AND TRACTION. TWO DIFFERENT TRIGGERS ARE INCLUDED IN THE PACKAGE, A FORWARD/STRAIGHT TRIGGER FOR MORE DRAW LENGTH AND SPEED, OR A COMFORT/RELAXED TRIGGER. THE FANG SERIES FEATURES A TWO SCREW TRIGGER SENSITIVITY SETTING, A SEPARATE TRIGGER TRAVEL ADJUSTMENT SCREW AND SEPARATE TRIGGER PRESSURE SETTING SCREW. COMBINE THESE ADJUSTMENTS WITH YOUR CHOICE OF THREE VARIED WEIGHT SPRINGS. THE ENTIRE FANG SERIES TUCKS AWAY EASILY IN A SLEEVE, THE FANG RC (ROPE STYLE CONNECTION), THE FANG (WEB STYLE CONNECTION) OR THE FANG GS (TUBULAR/GLOBO SWIVEL CONNECTION). ALL ARE ADJUSTABLE IN LENGTH TO FIT VIRTUALLY ANY SIZE DRAW LENGTH OR ANCHOR POINT. THE ADDED LOOK OF A RED ANODIZED HOOK AND TRIGGER CAN BE PAIRED WITH A BLACK BUCKLE OR CAMO VELCRO® STRAP.



FANG RC

ITEM: TFRB
- FANG RC - BLACK LEATHER BUCKLE STRAP

ITEM: TFRV
- FANG RC - CAMO VELCRO® STRAP



RED ROPE CONNECTOR

QUICK AND EASY ADJUSTMENT FOR ANY ANCHOR POINT
LESS TORQUE, GREATER ACCURACY
ADJUST VERY SHORT OR VERY LONG
TUCKS AWAY EASILY IN SLEEVE

SEE PG 9 FOR INSTRUCTIONS

FANG

ITEM: TFGB - FANG
- BLACK LEATHER BUCKLE STRAP

ITEM: TFGV - FANG
- CAMO VELCRO® STRAP



FANG GS

ITEM: TFSB - FANG GS
- BLACK LEATHER BUCKLE STRAP

ITEM: TFSV - FANG GS
- CAMO VELCRO® STRAP



FANG HANDLE MODELS

USAGE: HUNTING 

THE FANG SERIES OF HANDLES INCLUDES THE FANG 3, FANG 4 AND FANG MINI. THE ENTIRE SERIES FEATURES THE FULL CONTAINMENT SYSTEM (FCS) THAT ALLOWS THE ARCHER TO PUSH THE FCS SLIDE FORWARD TO LOCK THE RELEASE ONTO THE "D" LOOP, FOR USE IN A HANDS FREE HUNTING SITUATION, OR PULL THE SLIDE BACK FOR REPETITIVE SHOOTING. THE FANG SERIES PROVIDES THE ABILITY TO SHOOT WITH NO SENSITIVITY SPRING FOR THE LIGHTEST POSSIBLE SETTINGS AS WELL AS A MEDIUM AND HEAVY SPRING, INCLUDED IN THE PACKAGE FOR HEAVIER SENSITIVITY SETTINGS. A TRIGGER TRAVEL ADJUSTMENT SCREW ALLOWS FOR NUMEROUS DIFFERENT SETTINGS AS DESIRED BY THE ARCHER. ADJUSTABLE THUMB BARREL POSITIONS CAN BE ATTAINED WITH THE LARGE KNURLED THUMB PEG. PULL THE TRIGGER TO FIRE, PULL THE TRIGGER AGAIN TO RESET THE HOOK.

FULL CONTAINMENT SYSTEM (FCS)

CLICK CONTAINMENT BACK TO LOAD ON D-LOOP
CLICK FORWARD TO LOCK INTO POSITION
PULL TRIGGER TO FIRE
PULL TRIGGER AFTER FIRING TO RE-SET THE HOOK



FANG 4

ITEM: TFG4-BK
- FANG 4 - 4 FINGER



FANG 3

ITEM: TFG3-BK
- FANG 3 - 3 FINGER



FANG MINI

ITEM: TFG3-MN-BK
- FANG 3 MINI - 3 FINGER



MAX+ HUNTING SERIES

NEW 2019

COLOR OPTIONS:
- BLACK [BK] OR CAMO [CA]
FINGER CONFIGURATION OPTIONS:
- THREE FINGER OR FOUR FINGER

USAGE:
HUNTING 

ITEM: TMPP-BK - MAX PRO PLUS - BLACK
ITEM: TMPP-CA - MAX PRO PLUS - CAMO

ITEM: TMHP-BK - MAX HUNTER PLUS - BLACK
ITEM: TMHP-CA - MAX HUNTER PLUS - CAMO

MAXIMUM SAFETY!

USE BUILT-IN LANYARD TO KEEP RELEASE FROM SLAMMING THROUGH IF IT SLIPS OUT OF YOUR HAND

MAXIMUM DRAW LENGTH!

A SMALLER HEAD AND SMALLER JAWS FOR MORE DRAW LENGTH AND MORE BOW SPEED (FPS)

MAXIMUM SILENCE!

QUIET WHEN LOADING

MAXIMUM LOADING SPEED!

ACTIVATE TRIGGER TO OPEN JAWS, LET UP ON TRIGGER TO CLOSE THEM

AVAILABLE COLORS



MAX+ PRO

MAX+ HUNTER

1/2" SIZE ERGONOMIC HEAD
HEAD SWIVELS 360 DEGREES
EASY TO OPEN AND CLOSE JAWS
QUIET WHEN LOADING

1/2" SIZE ERGONOMIC HEAD
HEAD SWIVELS 360 DEGREES
EASY TO OPEN AND CLOSE JAWS
QUIET WHEN LOADING

FINGER BED GROOVES FOR ADDED GRIP

FINGER BED GROOVES FOR ADDED GRIP

BUILT-IN LANYARD

BUILT-IN LANYARD

ADJUSTABLE THUMB TRIGGER
PULL TO FIRE

TRIGGER FIRES BY PUSHING FORWARD

ADJUSTABLE SENSITIVITY SCREW

ADJUSTABLE SENSITIVITY SCREW

THE CHAMP

USAGE:
HUNTING 

SMALLER HEAD AND JAWS FOR MORE DRAW LENGTH AND FPS!

1/2" SIZE ERGONOMIC HEAD
HEAD SWIVELS 360 DEGREES
EASY TO OPEN AND CLOSE JAWS
QUIET WHEN LOADING

ADJUSTABLE SENSITIVITY SCREW



FINGER BED GROOVES FOR ADDED GRIP

ADJUSTABLE THUMB TRIGGER



SMALLER HEAD AND JAWS FOR MORE DRAW LENGTH AND FPS!

PERFECT FOR SMALLER HANDS!

DESIGNED FOR SMALLER HANDS WITH A SMALLER HEAD AND JAWS TO MAXIMIZE DRAW LENGTH, LOADING SPEED, AND SILENCE. PULL TRIGGER TO OPEN THE JAWS LET UP TO CLOSE THE JAWS. HEAD SWIVELS 360°. AVAILABLE IN BLACK ONLY AVAILABLE IN 3 FINGER MODELS ONLY. PERFECT FOR WOMEN AND SHOOTERS WITH SMALL HANDS. THE CHAMP.

ITEM: TCMP-BK - THE CHAMP - BLACK

T.R.U. BALL® ACCESSORY

+ PLUS STRAPS

NEW 2019

CAN ADD TO PLUS MODELS AND RELEASES WITH LANYARD FIXTURES

ITEM: TSBP-BK - PLUS STRAP - BLACK LEATHER BUCKLE STRAP

B. ITEM: TSTP-CA - PLUS STRAP - CAMO VELCRO® STRAP



RED ROPE CONNECTOR

QUICK AND EASY ADJUSTMENT FOR ANY ANCHOR POINT
LESS TORQUE, GREATER ACCURACY
ADJUST VERY SHORT OR VERY LONG TUCKS AWAY EASILY IN SLEEVE

SEE PG 9 FOR INSTRUCTIONS

HALF BRASS HALF ALUMINUM 3 AND 4 FINGER VERSION

BLADE PRO

- THINNER HEAD AND JAW TO REDUCE D-LOOP TORQUE
- FINGER BED GROOVES FOR ADDED GRIP
- SAFE FIRING MECHANISM
- SILENT & EASY COCKING FIRING MECHANISM
- BLADE PRO FEATURES MACHINED CHECKERED PATTERN TEXTURE ON EACH SIDE OF HANDLE
- PRO MODEL ADDS WEIGHT BY ITS HALF BRASS AND HALF ALUMINUM CONSTRUCTION
- BRASS PORTION IS COATED IN A CORROSION RESISTANT ELECTROLESS BRUSHED NICKEL QUICKSILVER FINISH

HANDLE SIZE OPTIONS:
- SMALL (3 FINGER ONLY), MEDIUM OR LARGE
FINGER CONFIGURATION OPTIONS:
- 3 FINGER OR 4 FINGER
COLOR OPTIONS:
- PURPLE/QS, BLACK/QS, SILVER/QS

USAGE:
TOURNAMENT

SAFE FIRING MECHANISM
- SO SAFE THAT EVEN IF A PIECE OF PAPER IS IN THE WAY, THE RELEASE WILL NOT SET

THINNER HEAD AND JAW TO REDUCE D-LOOP TORQUE

QS QUICKSILVER FINISH
CORROSION RESISTANT ELECTROLESS BRUSHED NICKEL PLATED BRASS

SILENT AND EASY COCKING FIRING MECHANISM

CHECKERED PATTERN TEXTURE ON EACH SIDE OF HANDLE

FINGER BED GROOVES FOR ADDED GRIP

ADDS WEIGHT BY HALF BRASS AND HALF ALUMINUM CONSTRUCTION

ADJUSTABLE KNURLED THUMB TRIGGER

ITEM: TBLD-BKQS-3M - BLADE PRO - BLACK/QS - 3 FINGER - MEDIUM

SPECIFY COLOR: BK - BLACK | PR - PURPLE | SI - SILVER
SPECIFY FINGER CONFIGURATION: 3 - 3 FINGER | 4 - 4 FINGER
SPECIFY HANDLE SIZE: S - SMALL (3 FINGER ONLY), M - MEDIUM, OR L - LARGE

SARA LOPEZ, COLOMBIA



ALL ALUMINUM 3 AND 4 FINGER VERSION

BLADE

HANDLE SIZE OPTIONS:
- MEDIUM OR LARGE
FINGER CONFIGURATION OPTIONS:
- THREE FINGER OR FOUR FINGER
USAGE:
TOURNAMENT

AIRCRAFT ALUMINUM FOR A LIGHTER HANDLE

KNIFE-LIKE CHECKERED PATTERN SIDE-PLATES

ITEM: TBLD-GYBK-3M OR L - BLADE - BLACK - 3 FINGER - MEDIUM OR LARGE
TBLD-GYBK-4M OR L - BLADE - BLACK - 4 FINGER - MEDIUM OR LARGE

BLADE MINI

AVAILABLE IN 3 FINGER ONLY

COLOR OPTIONS:
- PURPLE/QS, BLACK/QS, AND SILVER/QS
USAGE:
TOURNAMENT

AVAILABLE IN 3 FINGER ONLY
AVAILABLE IN PRO MODEL ONLY

ITEM: TBLD-BKQS-3S
- BLADE MINI - BLACK/QS - 3 FINGER
PR-PURPLE/QS | BK - BLACK/QS | SI - SILVER/QS

NEW 2019

RAVE

- ULTRA-QUIET
- TRIGGER ADJUSTABLE LIGHT TO HEAVY
- BUILT-IN LANYARD
- CRISP TRIGGER WITH A HARDENED SEAR INTERNAL FIRING MECHANISM
- COMFORTABLE 3 FINGER HANDLE
(SAME SIZE AS BLADE PRO 3 MEDIUM)
- EASY TO LOAD / PINCH JAW ONTO D-LOOP TO LOAD
- INDIVIDUAL TRAVEL AND SENSITIVITY ADJUSTMENT SCREWS WITH LOCKS
- MULTI-POSITIONAL THUMB BARREL AND TEARDROP



ITEM: TRV3-BK - RAVE - 3 FINGER - BLACK

SWEET SPOT II

LEARN BACK TENSION SAFELY

NEW 2019

SWEET SPOT PRO

USAGE: TOURNAMENT



COLOR OPTIONS:
- BLACK (BK), RED (RD) OR BLUE (BL)
FINGER CONFIGURATION OPTIONS:
- 4 FINGER, ULTRA 4, ULTRA 3 OR ULTRA 2

USAGE: TOURNAMENT

PATENTED FEATURES GIVE YOU THE SAME AMOUNT OF TRAVEL EACH TIME YOU SHOOT THE RELEASE. PUSH THE ACTIVATOR FORWARD TO DRAW YOUR BOW SAFELY AND RELEASE THE ACTIVATOR WHEN YOU ARE READY TO BEGIN BACK TENSION AND SHOOT. THE FINEST BACK TENSION TRAINING DEVICE TO EVER HIT THE ARCHERY MARKET!

- A. ITEM: 2SS4-BK
- SWEET SPOT II - 4 FINGER - BLACK
- B. ITEM: 2US4-BL
- SWEET SPOT II - ULTRA 4 - BLUE
- C. ITEM: 2US3-BK
- SWEET SPOT II - ULTRA 3 - BLACK
- D. ITEM: 2US2-RD
- SWEET SPOT II - ULTRA 2 - RED



AVAILABLE COLORS



ALL THREE INTERCHANGEABLE HANDLES IN ONE PACKAGE![®]
* PRO MODEL ONLY

ITEM: 2SPA-QS
- SWEET SPOT PRO - QUICKSILVER

QUICKSILVER FINISH
CORROSION RESISTANT ELECTROLESS
BRUSHED NICKEL PLATED BRASS



- ITEM: 2SH2-BK
- SWEET SPOT PRO - 2 FINGER HANDLE
- ITEM: 2SH3-BK
- SWEET SPOT PRO - 3 FINGER CLAW HANDLE
- ITEM: 2SH4-BK
- SWEET SPOT PRO - 4 FINGER HANDLE

NEW 2019

HT HYBRID FLEX

COLOR OPTIONS:
- BLACK (BK), BLUE (BL), RED (RD)
HANDLE SIZE OPTIONS:
- MEDIUM OR LARGE
USAGE: TOURNAMENT

BEST OF BOTH WORLDS IS THE NEW HT HYBRID FLEX: THE HT HYBRID FLEX IS A NEW ALL ALUMINUM BODY RELEASE WITH A BRASS INSERT TO INCREASE THE TOTAL MASS WEIGHT. IT IS THE BEST OF BOTH WORLDS BY HAVING THE ABILITY TO SHOOT THE RELEASE AS THE WEIGHT OF THE ORIGINAL ALUMINUM HT, OR BY ADDING THE INCLUDED BRASS INSERT FOR PRACTICALLY THE WEIGHT OF THE HT PRO(40Z), AN ALL BRASS HANDLE. NEWLY-ADDED ARTICULATING FINGER PIECES GIVE THE RELEASE THE VERSATILITY OF A THREE FINGER OR FOUR FINGER MODEL, WITH ALL OPTIONS INCLUDED WITH THE RELEASE. THE POPULAR HT MICRO-ADJUSTABLE SPEED DIAL SEAR WITH LOCK SCREW IS STANDARD ON ALL HT HYBRID FLEX RELEASES, AND AN OPTIONAL FAST SEAR IS SOLD SEPARATELY. THE HT HYBRID FLEX FEATURES A BLACK HEAD AND FINGER PIECES AND IS AVAILABLE IN BLACK, RED AND BLUE HANDLES IN MEDIUM OR LARGE SIZES. THE STANDARD SMALL KNURLED THUMB PEG HAS TWO LOCATIONS FOR A CUSTOMIZED FIT.

ITEM: THTH-BKBS-M - HT HYBRID FLEX - BLACK/BRASS - MEDIUM

SPECIFY COLOR: BK - BLACK | RD - RED | BL - BLUE
SPECIFY HANDLE SIZE: M - MEDIUM, OR L - LARGE



SET YOUR HEAT!
MICRO-ADJUSTABLE BACK TENSION WITH INDICATOR

TWO THUMB-PIN LOCATIONS

BRASS INSERT DOUBLES THE WEIGHT OF THE RELEASE

ALUMINUM INSERT INCLUDED REPLACES BRASS INSERT FOR LIGHTER HANDLE FEEL

NEW ULTRA-FLEX PERSONALIZED FIT SYSTEM-HI-DEF KNURLED FINGER BEDS

3 AND 4 FINGER ARTICULATING HANDLE PIECES INCLUDED

HT HOT TENSION

HANDLE SIZE OPTIONS:
- BABY HT (3 FINGER ONLY), MEDIUM OR LARGE
FINGER CONFIGURATION OPTIONS:
- 4 FINGER, 3 FINGER, 2 FINGER OR BABY HT (3 FINGER ONLY)

USAGE: TOURNAMENT

SET YOUR HEAT!



A MICRO-ADJUSTABLE BACK TENSION RELEASE THAT ALLOWS YOU TO SET THE HEAT AND FINE TUNE YOUR RELEASE TO YOUR PREFERENCE. THE HT IS AVAILABLE AS A 2, 3, OR 4 FINGER MODEL IN YOUR CHOICE OF MEDIUM OR LARGE DESIGNS (4 FINGER LARGE ONLY). ALL HANDLES ARE ALSO TAPERED NEAR THE RING AND PINKY FINGERS FOR AN ERGONOMIC FEEL. A SMALLER, THINNER BABY HT IS AVAILABLE FOR SMALLER HANDS IN 3 FINGER ONLY.

* WHILE SUPPLIES LAST

- E. ITEM: THT3 - HT 3 - M OR L
- F. ITEM: THT4 - HT 4 - LARGE ONLY
- G. ITEM: THT2 - HT 2 - M OR L
- H. ITEM: THT3-S - BABY HT - S



SIGNATURE SERIES



Chin Saan-Shiang
Institute of Molecular Medicine
at Windber

EVERY RELEASE SOLD, A PERCENTAGE OF THE SALES WILL GO TO THE CHIN SAAN-SHIANG INSTITUTE OF MOLECULAR MEDICINE AT WINDBER TO HELP FIGHT BREAST CANCER. THAT IS WHAT I AM MOST EXCITED ABOUT KNOWING THAT WE ARE HELPING SUPPORT A GOOD CAUSE. THAT MAKES ME FEEL GREAT!



JESSE BROADWATER, USA

USE THE THUMB TRIGGER AND BACK TENSION INTERCHANGEABLY MATCHING SPECIFICATIONS FOR DRAW LENGTH AND ANCHOR POINT TO ALLOW INTERCHANGEABILITY

ABYSS FLEX

HANDLE SIZE OPTIONS:
MEDIUM OR LARGE

USAGE:
TOURNAMENT

THE ABYSS FLEX IS A CNC-MACHINED, WEIGHTED Q5 BRASS THUMB-ACTIVATED RELEASE WITH A HANDLE AND LAS LEVER ALIGNMENT SYSTEM THAT PERFECTLY MATCHES THE FULKRUM FLEX SO YOU CAN SHOOT THEM INTERCHANGEABLY WITH THE SAME IMPACT POINTS. THE ABYSS FLEX HAS A SINGLE SENSITIVITY ADJUSTMENT SCREW WITH A LOCK THAT CAN BE ADJUSTED INFINITELY FOR YOUR PERSONAL FEEL. THE ABYSS FLEX CONTAINS COMFORT FLEX TECHNOLOGY THAT NOW ALLOWS THE ARCHER TO MOVE EACH FINGER LOCATION A TOTAL OF 30 DEGREES FOR AN EXACT, ERGONOMICALLY-PRECISE FEEL. THE ABYSS FLEX FEATURES A SIMPLE LOCKING TRAVEL ADJUSTMENT SCREW, THAT ALLOWS YOU TO SET THE TRAVEL TO YOUR PREFERENCE QUICKLY AND EASILY. OUR MOST ADJUSTABLE THUMB TRIGGER COMES STANDARD ON THE ABYSS FLEX ALLOWING YOU TO CREATE A RELEASE THAT EXACTLY FITS YOUR HAND AND SHOOTING STYLE. ALL ABYSS FLEX MODELS CONTAIN THE PIECES TO MAKE YOUR RELEASE A THREE FINGER OR A FOUR FINGER RELEASE. CRISP, CLEAN AND COMFORTABLE SHOTS ARE WHAT YOU CAN EXPECT WITH THE ABYSS FLEX.

ITEM: TABF-QS-M
- ABYSS FLEX - QUICKSILVER - MEDIUM

SPECIFY HANDLE SIZE:
M - MEDIUM, OR L - LARGE

- INDIVIDUAL TRAVEL AND SENSITIVITY ADJUSTMENTS
- LEVER ALIGNMENT SYSTEM (LAS)
4-DIFFERENT POSSIBLE LOCATIONS
- ADJUSTABLE ANGLE FINGER PIECES
30° OF RADIAL ADJUSTMENT TOTAL IN EACH FINGER GRIP LOCATION

MULTI-POSITION THUMB BARREL



PATENTED THE FIRST AND BEST ADJUSTABLE FINGERS!
COMFORT FLEX
TECHNOLOGY

CREATE A RELEASE WITH A FLAT HANDLE FINGER BED, A SWEPT HANDLE FINGER BED, OR YOUR INDIVIDUAL PREFERENCE OF ANYTHING IN-BETWEEN

PACKAGE INCLUDES BOTH 3 AND 4 FINGER PIECES

FEATURING
QUICKSILVER FINISH
CORROSION RESISTANT
ELECTROLESS BRUSHED
NICKEL PLATED BRASS

ADJUSTABLE 4 FINGER
PIECE: 30° OF RADIAL
ROTATION (15° FORWARD
AND 15° BACK) IN 2 LOCATIONS

ADJUSTABLE 3 FINGER PIECE:
30° OF RADIAL ROTATION
(15° FORWARD AND 15° BACK)
IN 1 LOCATION

FULKRUM FLEX

HANDLE SIZE OPTIONS:
SMALL, MEDIUM OR LARGE

USAGE:
TOURNAMENT

THE FULKRUM FLEX IS A MICRO ADJUSTABLE HINGE/BACK TENSION RELEASE, WITH A NICELY WEIGHTED Q5 BRASS BODY, AN ENCLOSED SMOOTH INDEX FINGER AND KNURLED MIDDLE, RING AND PINKY FINGERS, SO IT'S SURE TO PROVIDE A GREAT FEEL. THE FULKRUM FLEX FEATURES THE COMFORT FLEX TECHNOLOGY THAT ALLOWS THE ARCHER TO SELECT INFINITE FINGER BED LOCATIONS ON BOTH THE THIRD FINGER AND FOURTH FINGER HANDLE PIECES. EACH PIECE CAN INDIVIDUALLY MOVE 30 DEGREES. THE FULKRUM FLEX HAS THE LEVER ALIGNMENT SYSTEM LAS TECHNOLOGY THAT ALLOWS THE ARCHER TO MOVE THE HEAD OF THE RELEASE AROUND THE OUTSIDE EDGE OF THE INDEX FINGER, THIS MOVES THE FULCRUM POINT OF THE RELEASE TO DIFFERENT LOCATIONS THAT MAKE THE RELEASE FIRE EASIER IN DIFFERENT INDIVIDUAL SHOOTING STYLES. THE FULKRUM FLEX ALSO ALLOWS THE ARCHERS WHO HAVE ACCURACY ROBBING STRING OR VANE CONTACT WITH THEIR FACE AT FULL DRAW THE ABILITY TO ADJUST THIS WITH THE LAS. HAS TWO SEPARATE SEARS ONE WITH A CLICK AND ONE WITHOUT A CLICK AND FEATURES A MICRO-ADJUSTABLE SEAR THAT CAN BE ADJUSTED WITH THE INCLUDED TOOL THAT SCREWS INTO THE HANDLE TO REMAIN WITH YOUR RELEASE AT ALL TIMES. THE MICRO-ADJUSTABLE SEAR HAS A LOCK SCREW THAT NEEDS TO BE LOOSENED PRIOR TO MAKING ANY TRAVEL ADJUSTMENT AND THEN RE-TIGHTENED AFTER ADJUSTING. LASER ENGRAVED REFERENCE MARKS ARE EASILY VISIBLE FOR REFERENCING YOUR SETTING. THE FULKRUM FLEX AND ABYSS FLEX PROVIDE YOU WITH ACCURACY BUSTING TECHNOLOGY WITH THE SAME HANDLE AND IMPACT POINTS AS EACH OTHER.

ITEM: TFLF-QS-M
- FULKRUM FLEX - QUICKSILVER - MEDIUM

SPECIFY HANDLE SIZE:
S - SMALL, M - MEDIUM, OR L - LARGE

- BACK TENSION RELEASE
- LEVER ALIGNMENT SYSTEM (LAS)
4-DIFFERENT POSSIBLE LOCATIONS
- ADJUSTABLE ANGLE FINGER PIECES
30° OF RADIAL ADJUSTMENT TOTAL IN EACH FINGER GRIP LOCATION
- SEPARATE CLICK AND NON-CLICK SEARS (BOTH INCLUDED)
- INCLUDES SPECIAL TOOL FOR ADJUSTMENTS,
SCREWS INTO THE HANDLE OF THE RELEASE

TRIGGERLESS BACK-TENSION RELEASE



PATENTED THE FIRST AND BEST ADJUSTABLE FINGERS!
COMFORT FLEX
TECHNOLOGY

CREATE A RELEASE WITH A FLAT HANDLE FINGER BED, A SWEPT HANDLE FINGER BED, OR YOUR INDIVIDUAL PREFERENCE OF ANYTHING IN-BETWEEN
PACKAGE INCLUDES BOTH 3 AND 4 FINGER PIECES

FEATURING
QUICKSILVER FINISH
CORROSION RESISTANT
ELECTROLESS BRUSHED
NICKEL PLATED BRASS

ADJUSTABLE 3 FINGER PIECE:
30° OF RADIAL ROTATION
(15° FORWARD AND 15° BACK)
IN 1 LOCATION

ADJUSTABLE 4 FINGER PIECE:
30° OF RADIAL ROTATION
(15° FORWARD AND 15° BACK)
IN 2 LOCATIONS

MICRO-ADJUSTABLE SEAR HEAD

LEVER ALIGNMENT SYSTEM

ONBOARD ADJUSTMENT TOOL

ITEM: TFLF-TOOL



Reo Wilde
SIGNATURE SERIES

NEW 2019
THE GOAT

A TRIGGER AND HINGE ACTIVATED BACK TENSION IN ONE RELEASE

HANDLE SIZE OPTIONS:
MEDIUM OR LARGE

USAGE:
TOURNAMENT

THE REO WILDE SIGNATURE SERIES GOAT COMBINES TWO OF THE MOST POPULAR METHODS OF ACTIVATION INTO ONE UNPRECEDENTED RELEASE. THE GOAT CAN BE USED AS A THUMB ACTIVATED TRIGGER RELEASE OR HINGE RELEASE IN THREE EASY STEPS, TAKING ABOUT 30 SECONDS TO SWITCH. THE GOAT COMES WITH A HALF NICKEL PLATED BRASS, HALF BLACK ALUMINUM TAPERED HANDLE, AND ARTICULATING FINGER PIECES TO MAKE THE RELEASE A THREE OR FOUR FINGER CONFIGURATION. THE GOAT IN THE PACKAGE IS SET AS A THUMB ACTIVATED RELEASE, WITH INDIVIDUAL TRIGGER TRAVEL AND TRIGGER SENSITIVITY SCREWS WITH LOCKS. REMOVE A SINGLE DOWEL (STEP 1), TURN SEAR LOCK SCREW CLOCKWISE UNTIL TIGHT (STEP 2) AND TURN TRIGGER LOCK SCREW CLOCKWISE UNTIL TIGHT (STEP 3) TO MAKE THE GOAT A HINGE STYLE RELEASE, IT IS THAT SIMPLE! THE GOAT AS A HINGE COMES STANDARD WITH A MEDIUM CLICK INSTALLED AND A NO CLICK OPTION CAN BE ACHIEVED BY FLIPPING THE SEAR 180 DEGREES. THERE WILL BE AN OPTION FOR A FAST CLICK. TREAT YOURSELF, AND TRY THE GOAT ONE OF THE MOST INNOVATIVE RELEASES TO EVER HIT THE MARKET.

ITEM: TGOT-BKQS-M
- THE GOAT - BLACK / QUICKSILVER - MEDIUM

SPECIFY HANDLE SIZE:
M - MEDIUM, OR L - LARGE

SEPARATE MICRO-ADJUST SETTINGS FOR HINGE AND TRIGGER THAT DO NOT CHANGE WHEN TRANSFORMING

EASILY TRANSFORMS BACK & FORTH FROM TRIGGER TO HINGE ACTIVATED BACK TENSION

ALL NEW MULTI-POSITION OFFSET TRIGGER THUMB BARREL

CRISP TRIGGER WITH A HARDENED STAINLESS STEEL SEAR INTERNAL FIRING MECHANISM

HALF QUICKSILVER NICKEL PLATED BRASS HANDLE FOR WEIGHT

ALL ADJUSTMENT SETTINGS HAVE LOCK SCREWS

FEATURING
QUICKSILVER FINISH
CORROSION RESISTANT ELECTROLESS BRUSHED NICKEL PLATED BRASS

PATENTED THE FIRST AND BEST ADJUSTABLE FINGERS!
NEW ULTRA-FLEX PERSONALIZED FIT SYSTEM-

HI-DEF KNURLED FINGER BEDS
- 3 AND 4 FINGER ARTICULATING HANDLE PIECES INCLUDED



HONEY BADGER CLAW HBC

HANDLE SIZE OPTIONS:
- SMALL (3 FINGER ONLY), MEDIUM OR LARGE
FINGER CONFIGURATION OPTIONS:
- THREE FINGER OR FOUR FINGER

USAGE:
TOURNAMENT

MADE OF SOLID BRASS!
THIS MODEL FEATURES AN ERGONOMIC HANDLE THAT TAPERS SMALLER TOWARD THE PINKY. THE H.B.C. IS AVAILABLE IN A 3 FINGER (SIZES SMALL, MEDIUM, OR LARGE) AND A 4 FINGER MODEL (SIZES MEDIUM OR LARGE). MICRO-ADJUST ONE SCREW USING VISUAL SPEED DIAL TO REFERENCE SETTINGS. TURN IN TO MAKE RELEASE HOTTER (FASTER), BACK OUT TO MAKE SLOWER. OFFERED WITH THE QUICKSILVER FINISH OPTION, A CORROSION RESISTANT ELECTROLESS BRUSHED NICKEL PLATED FINISH. ASSEMBLED WITH A STANDARD CLICK OR NO-CLICK, BUT A FAST CLICK IS SOLD SEPARATELY.

ITEM: THBC-QS-3M
- HONEY BADGER CLAW - QUICKSILVER - 3 FINGER - MEDIUM

SPECIFY FINGER CONFIGURATION: 3 - 3 FINGER | 4 - 4 FINGER
SPECIFY HANDLE SIZE: S - SMALL (3 FINGER ONLY), M - MEDIUM, OR L - LARGE

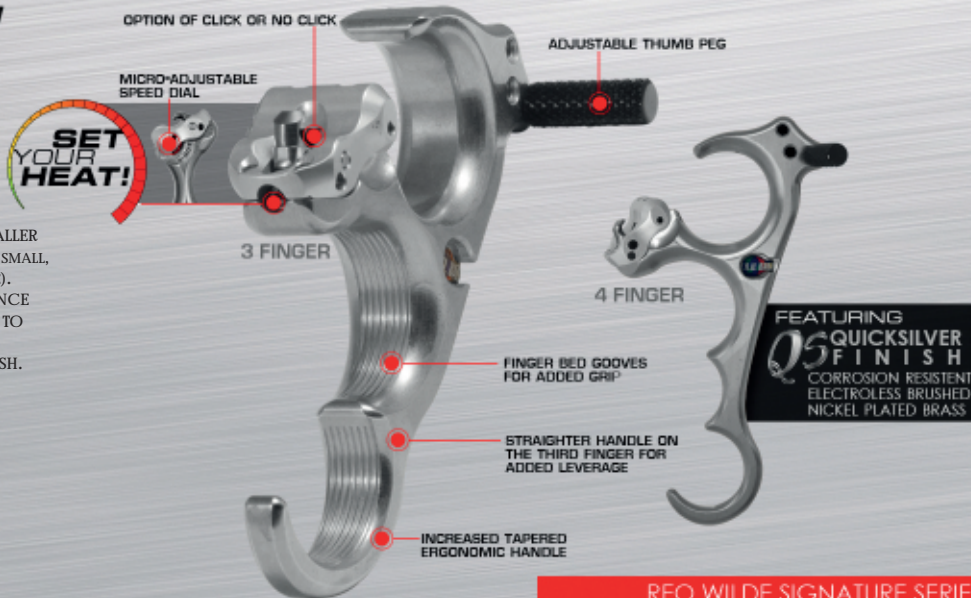

OPTION OF CLICK OR NO CLICK

ADJUSTABLE THUMB PEG

MICRO-ADJUSTABLE SPEED DIAL

SET YOUR HEAT!

3 FINGER

4 FINGER

FINGER BED GOOVES FOR ADDED GRIP

STRAIGHTER HANDLE ON THE THIRD FINGER FOR ADDED LEVERAGE

INCREASED TAPERED ERGONOMIC HANDLE

FEATURING
QUICKSILVER FINISH
CORROSION RESISTANT ELECTROLESS BRUSHED NICKEL PLATED BRASS

AXSERIES

TRIED AND TRUE, WITH THE FINEST (0.00156) CLICKS ON THE MARKET, THE AUTOMATIC GIB TENSION SYSTEM, AND THE HEAVY DUTY STAINLESS STEEL ACME THREADED ELEVATION ROD, DEPENDABILITY AND DURABILITY AT ITS FINEST.



ITEM SHOWN:
AV41-TSCPPLUS-GR
SHOWN IN GREEN - SOLD SEPARATELY
- SEE PAGES 18-19 FOR DETAILS

AX3000 CARBON

3 INCHES OF ELEVATION ADJUSTMENT
POPULAR WITH: 3D & FIELD

ITEM SHOWN: **AX30-6CR-BB**
- AX3000 - 6" CARBON BAR - BLACK/BLACK COLOR

HEAVY DUTY STAINLESS STEEL
ACME THREADED ROD

CARBON
EXTENSION BAR

RAPID TRAVEL
MAKE QUICK ELEVATION
ADJUSTMENTS WITH
SMOOTH HYDRAULIC FEEL

REMOVABLE BLOCK
EASILY CHANGE OUT MULTIPLE
SET-UPS, WHILE MAINTAINING
ALIGNMENT



ORDERING INSTRUCTIONS:

ITEM: **AX30-6DR-BB**

AX SERIES

MODEL:
30 = AX3000
45 = AX4500

BAR SIZE:
6 = 6" BAR
9 = 9" BAR

RIGHT HAND/LEFT HAND

R = RIGHT HAND

L = LEFT HAND

EXTENSION BAR

D = DAMPENED

N = NON-DAMPENED

C = CARBON

ALSO AVAILABLE WITH AN ALUMINUM EXTENSION BAR
- AVAILABLE WITH OR WITHOUT DAMPER

AX3000

ITEM: **AX30-6DR-BB**
- AX3000 - 6" DAMPENED BAR
- BLACK/BLACK COLOR



OPTION
**Harmonic
Dampers**

FINEST CLICKS

THE BEST ACCURACY (0.0156% PER CLICK) WITH MORE TRAVEL,
40 CLICKS PER REVOLUTION, (0.0825% PER REVOLUTION) 20
CLICKS PER REVOLUTION ON WINDAGE, (0.0825% PER REVOLUTION)

ELEVATION BLOCK FEATURES EASILY
ACCESSIBLE SIGHT SCALE POINTER SCREWS

ENGINEERS ALSO ADDED THREAD DEPTH FOR DURABILITY WHEN
ATTACHING AN AXCEL SIGHT MAGNIFIER.
(SEE ACCESSORIES BELOW)

AUTO ADJUSTMENT AUTOMATIC GIB TENSION SYSTEM
NO SCREWS TO ADJUST!

FEATURING A ONE PIECE ALL ALUMINUM
REMOVABLE QUICK CHANGE KNOB



USE 32(PITCH) x 20(CLICKS)
RATIO FOR COMPUTER SIGHT SCALE PRINTOUTS

AX4500

4.5 INCHES OF ELEVATION ADJUSTMENT
POPULAR WITH: RECURVE

ITEM SHOWN:
AX45-9NR-B-BB
- AX4500 - 9" NON-DAMPENED BAR
- #8-32 THREADED BLOCK
- BLACK/BLACK COLOR



AX4500 AVAILABLE WITH 2ND/3RD
AXIS BLOCK INSTALLED WITH 6" OR 9"
DAMPENED OR NON-DAMPENED BARS

ITEM: **AX45-9NR-BB**

SHOWN WITH RECURVE #8-32
THREADED BLOCK
INSTALLED

ITEM:
ACHV-RRB
SEE BELOW FOR DETAILS

TOJA ELLISON
SLOVENIA



AXCEL TOURNAMENT SIGHTS | ACCESSORIES

SCOPE COVER

PROTECTS SCOPE WHEN
NOT IN USE

ITEM: **AXSC-BK**
REGULAR

ITEM: **AXSC-BK-XL**
EXTRA LARGE



RECURVE SIGHT
SOFT CASE
ITEM: **AXBX-RS**

TOURNAMENT SIGHT
HARD CASE
ITEM: **AXBX-TS**

SCOPE BARREL

ITEM: **AXSB**
- HEX/SQUARE-END, NON-THREADED

ITEM: **AXSB-10**
- HEX/SQUARE-END, THREADED #10-32



OFFSET BLOCK

ACHIEVE
AND **AXSERIES**

ITEM: **AXOB**
- DESIGNED FOR 9/16" GREATER WINDAGE
ADJUSTMENT (LEFT OR RIGHT)



MAGNIFIER SIGHT SCALE WITH COVER

AXSERIES

ITEM: **AXMS-W**

- AX SERIES WIDE MAGNIFIER SIGHT SCALE WITH COVER



MAGNIFIER SIGHT SCALE WITH COVER

ACHIEVE **ACHIEVE**
XP

ITEM: **ACHV-MSW**
- ACHIEVE SERIES WIDE MAGNIFIER SIGHT SCALE WITH COVER



AXSERIES | **ACHIEVE**
ALL COMPOUND MODELS

REMOVABLE QUICKCHANGE

EASILY CHANGE OUT MULTIPLE SET-UPS,
WHILE MAINTAINING ALIGNMENT

ITEM: **AXRB**
- 2"/3" AXIS NON-THREADED SCOPE BLOCK

ITEM: **AXRB-H**
- 2"/3" AXIS THREADED SCOPE BLOCK



AXSERIES | **ACHIEVE**
ALL RECURVE MODELS

#8-32 REMOVABLE QUICKCHANGE

ITEM: **ACHV-RRB**
- ACHIEVE SERIES RECURVE #8-32
THREADED BLOCK



ACHIEVE SERIES

TOP FEATURES

WINDAGE DOVETAIL GUIDE SYSTEM

THE SUPERIOR "WINDAGE DOVETAIL GUIDE SYSTEM", REPLACES INFERIOR TWIN-DOWEL GUIDE SYSTEMS.



VARIABLE TENSION SYSTEM WITH LOCK



THE "VTS" (VARIABLE TENSION SYSTEM WITH LOCK), PROVIDES A NEW ADJUSTMENT WHERE THE ARCHER PERSONALLY CHOOSES A DESIRED ELEVATION TRAVEL TENSION SETTING AND INCORPORATES AN ADDED LOCK FEATURE MOST COMMONLY USED IN SINGLE DISTANCE TOURNAMENTS.

- ELEVATION: 20 CLICKS PER REVOLUTION
- WINDAGE: 20 CLICKS PER REVOLUTION
- TRAVEL: 0.00156"



RECURVE SIGHT
BLUE/BLACK COLOR COMBO
9" CARBON BAR WITH LOCK
ITEM: ACHV-RCBLR-LB



ZERO BACKLASH!!

QUICK CHANGE SCOPE KNOB



RECURVE SIGHT
ORANGE/BLACK COLOR COMBO
9" ALUMINUM BAR WITH LOCK
ITEM: ACHV-RXL-RH-OB

RECURVE

ALUMINUM BAR ORDERING INSTRUCTIONS:
ACHIEVE

MODEL:
R = RECURVE
C = COMPOUND
BAR SIZE (COMPOUND ONLY)
6" = 6" BAR
9" = 9" BAR

COLOR - SEE CHART
RIGHT HAND / LEFT HAND
R = RIGHT HAND
L = LEFT HAND
DAMPENED / NON-DAMPENED
D = DAMPENED
N = NON-DAMPENED



ZERO BACKLASH!!

QUICK CHANGE SCOPE KNOB



COMPOUND SIGHT
BLACK/BLACK COLOR COMBO
9" CARBON BAR WITH LOCK
ITEM: ACHV-CBL9R-BB



COMPOUND SIGHT
RED/BLACK COLOR COMBO
6" DAMPENED ALUMINUM BAR WITH LOCK
ITEM: ACHV-CXL6DR-RB

COMPOUND



CARBON BAR ORDERING INSTRUCTIONS:
ACHIEVE

MODEL:
RCB = RECURVE
CB = COMPOUND
BAR SIZE (COMPOUND ONLY)
6" = 6" BAR
9" = 9" BAR

COLOR - SEE CHART
RIGHT HAND / LEFT HAND
R = RIGHT HAND
L = LEFT HAND



OPTIONAL MATHEWS® HARMONIC DAMPER™ AVAILABLE ON ACHIEVE COMPOUND ALUMINUM SIGHTS

COLOR OPTIONS



A. BB - (BLACK / BLACK) B. SB - (SILVER / BLACK) C. OB - (ORANGE / BLACK) D. RB - (RED / BLACK) E. EB - (GREEN / BLACK) F. UB - (PURPLE / BLACK) G. LB - (BLUE / BLACK) H. GB - (GOLD / BLACK)



ITEM: ACHV-MB + COLOR CHOICE
*ALL COLORS WHILE SUPPLIES LAST

- COLOR CODE: BB BLACK BRACKET
- COLOR CODE: SB SILVER BRACKET
- COLOR CODE: OB ORANGE BRACKET
- COLOR CODE: RB RED BRACKET
- COLOR CODE: EB GREEN BRACKET
- COLOR CODE: UB PURPLE BRACKET
- COLOR CODE: LB BLUE BRACKET
- COLOR CODE: GB GOLD BRACKET



ITEM: AXMB + COLOR CHOICE

- COLOR CODE: BB BLACK BRACKET
- COLOR CODE: SB SILVER BRACKET

*WHILE SUPPLIES LAST

REPLACEMENT KNOBS



(SET OF 5)
AX SERIES
- ITEM: AXKS
ACHIEVE
- ITEM: ACHV-KS

EXTENSION BARS

AXSERIES | ACHIEVE ALL COMPOUND MODELS ALUMINUM EXTENSION BARS

- AXEX-6DR EXTENSION BAR - 6" WITH DAMPER, RIGHT HAND
- AXEX-9DR EXTENSION BAR - 9" WITH DAMPER, RIGHT HAND
- AXEX-6DL EXTENSION BAR - 6" WITH DAMPER, LEFT HAND
- AXEX-9DL EXTENSION BAR - 9" WITH DAMPER, LEFT HAND
- AXEX-6NR EXTENSION BAR - 6" WITHOUT DAMPER, RIGHT HAND
- AXEX-9NR EXTENSION BAR - 9" WITHOUT DAMPER, RIGHT HAND
- AXEX-6NL EXTENSION BAR - 6" WITHOUT DAMPER, LEFT HAND
- AXEX-9NL EXTENSION BAR - 9" WITHOUT DAMPER, LEFT HAND

ACHIEVE ALL RECURVE MODELS ALUMINUM EXTENSION BARS

- ACHV-REX-RH-B RECURVE EXTENSION BAR - 9", RIGHT HAND, BLACK
- ACHV-REX-RH-S RECURVE EXTENSION BAR - 9", RIGHT HAND, SILVER
- ACHV-REX-LH-B RECURVE EXTENSION BAR - 9", LEFT HAND, BLACK
- ACHV-REX-LH-S RECURVE EXTENSION BAR - 9", LEFT HAND, SILVER

AXSERIES | ACCUTOUCH PRO CARBON EXTENSION BARS

- AXEX-6CR SOLID CARBON EXTENSION BAR - 6", RIGHT HAND
- AXEX-6CL SOLID CARBON EXTENSION BAR - 6", LEFT HAND
- AXEX-9CR SOLID CARBON EXTENSION BAR - 9", RIGHT HAND
- AXEX-9CL SOLID CARBON EXTENSION BAR - 9", LEFT HAND

ACHIEVE CARBON CARBON EXTENSION BARS

- ACHV-CBEX6R CARBON EXTENSION BAR - 6", RIGHT HAND
- ACHV-CBEX6L CARBON EXTENSION BAR - 6", LEFT HAND
- ACHV-CBEX9R CARBON EXTENSION BAR - 9", RIGHT HAND
- ACHV-CBEX9L CARBON EXTENSION BAR - 9", LEFT HAND

TOURNAMENT SCOPES

CHOOSE SCOPE STYLE

ACCU-VIEW AV-41
41MM | 1-3/4" DIAMETER APERTURE
FITS 44.5 MM LENS

AV41 PLUS / DOC'S CHOICE LENS COMBO KITS
AV41-P
SPECIFY POWER 2X, 4X, 6X, OR 8X,
AV41 PLUS SCOPE W/ DOC'S CHOICE 1-3/4" DIA LENS COMBO - "T" CONNECTOR



ACCU-VIEW AV-31
31MM | 1-3/8" DIAMETER APERTURE
FITS 34.5 MM LENS

AV31 PLUS / DOC'S CHOICE LENS COMBO KITS
AV31-P
SPECIFY POWER 2X, 4X, 6X, OR 8X,
AV31 PLUS SCOPE W/ DOC'S CHOICE 1-3/8" DIA LENS COMBO - "T" CONNECTOR



ACCU-VIEW AV-25
25MM | 1-1/8" DIAMETER APERTURE
FITS 29 MM LENS

AV25 PLUS / DOC'S CHOICE LENS COMBO
AV25-P
SPECIFY POWER 2X, 4X, 6X, OR 8X,
AV25 PLUS SCOPE W/ DOC'S CHOICE 29MM DIA LENS COMBO - "T" CONNECTOR



CURVE RX RECURVE SCOPE

- AC14-RX SCOPE ONLY WITH #8-32 ROD (NO FIBERS OR LENS)
- AC14-RX19 WITH CT X-ZONE .019" DRILLED OX LENS
- AC14-RX29 WITH CT X-ZONE .029" DRILLED OX LENS
- AC14-RXP19- FIBER COLOR: WITH .019" FIRE RING PIN - RHEOSTAT CT X-ZONE .019" DRILLED OX LENS
- AC14-RXP29- FIBER COLOR: WITH .029" FIRE RING PIN - RHEOSTAT CT X-ZONE .029" DRILLED OX LENS
- AC14-RXP10- FIBER COLOR: WITH .010" FIRE RING PIN - RHEOSTAT CT X-ZONE .019" DRILLED OX LENS

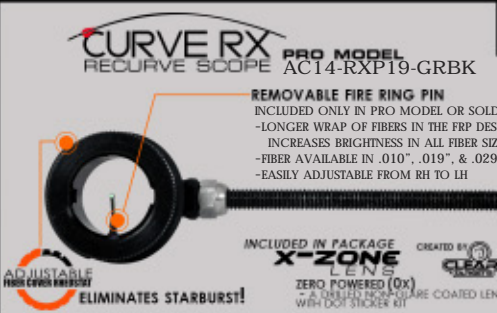

CURVE CX COMPOUND SCOPE

- AC14-CX SCOPE ONLY NO RING PIN, RHEOSTAT COVER OR LENS
 - AC14-CXP19- WITH .019" FIRE RING PIN & RHEOSTAT COVER
 - AC14-CXP29- WITH .029" FIRE RING PIN & RHEOSTAT COVER
 - AC14-CXP10- WITH .010" FIRE RING PIN & RHEOSTAT COVER
- SPECIFY FIBER COLOR GREEN - GR OR RED - RD



CURVE RXF RECURVE SCOPE

- AC14-RXF19-RH-__B .019" FIBER SIZE - RIGHT HAND
 - AC14-RXF19-LH-__B .019" FIBER SIZE - LEFT HAND
 - AC14-RXF29-RH-__B .029" FIBER SIZE - RIGHT HAND
 - AC14-RXF29-LH-__B .029" FIBER SIZE - LEFT HAND
- SPECIFY FIBER COLOR GREEN - G OR RED - R

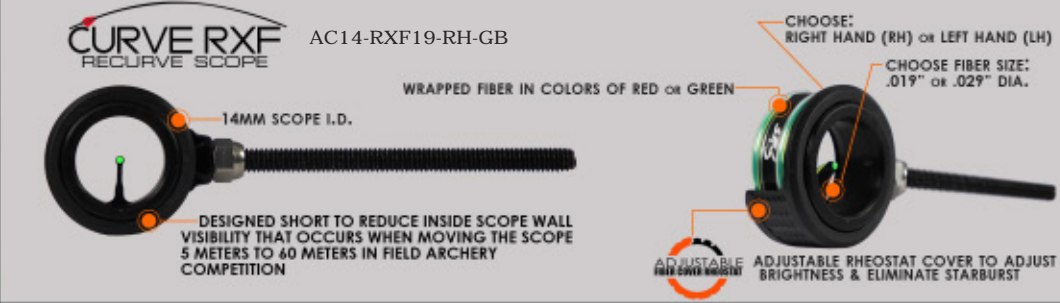

14MM TOURNAMENT SCOPES

18 TOURNAMENT SCOPES

ALL CURVE SCOPES ARE PATENT PENDING

CHOOSE COLOR



CHOOSE AIMING POINT



CHOOSE LENS AND RETICLES



OPTIONAL EXTRA ACCESSORIES

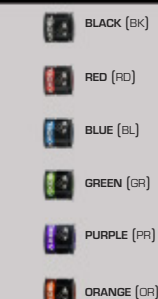
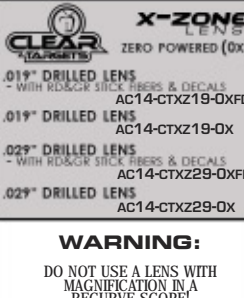
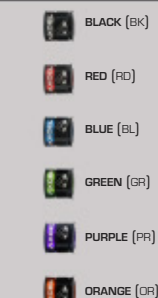
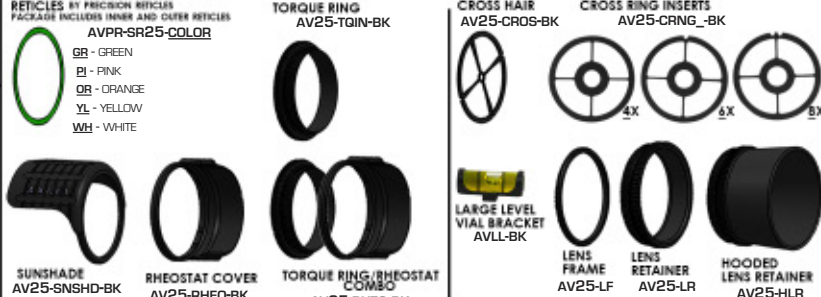
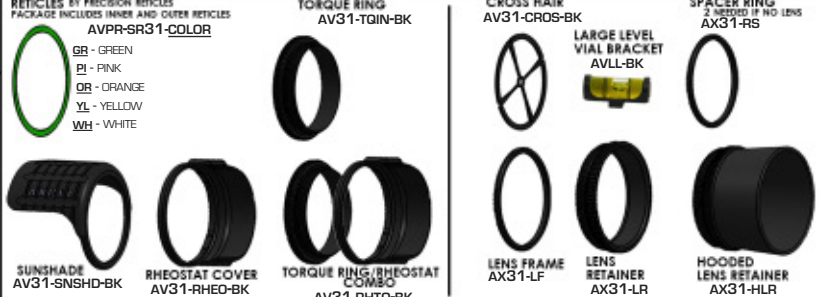
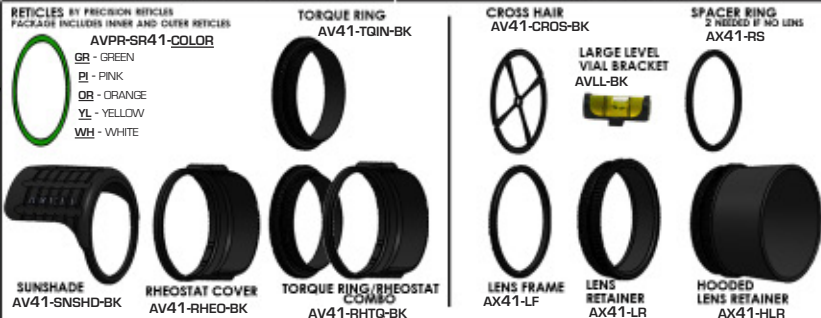

ACCUTOUCH

SINGLE-PIN SLIDER SIGHT WITH ACCU-VIEW SCOPE

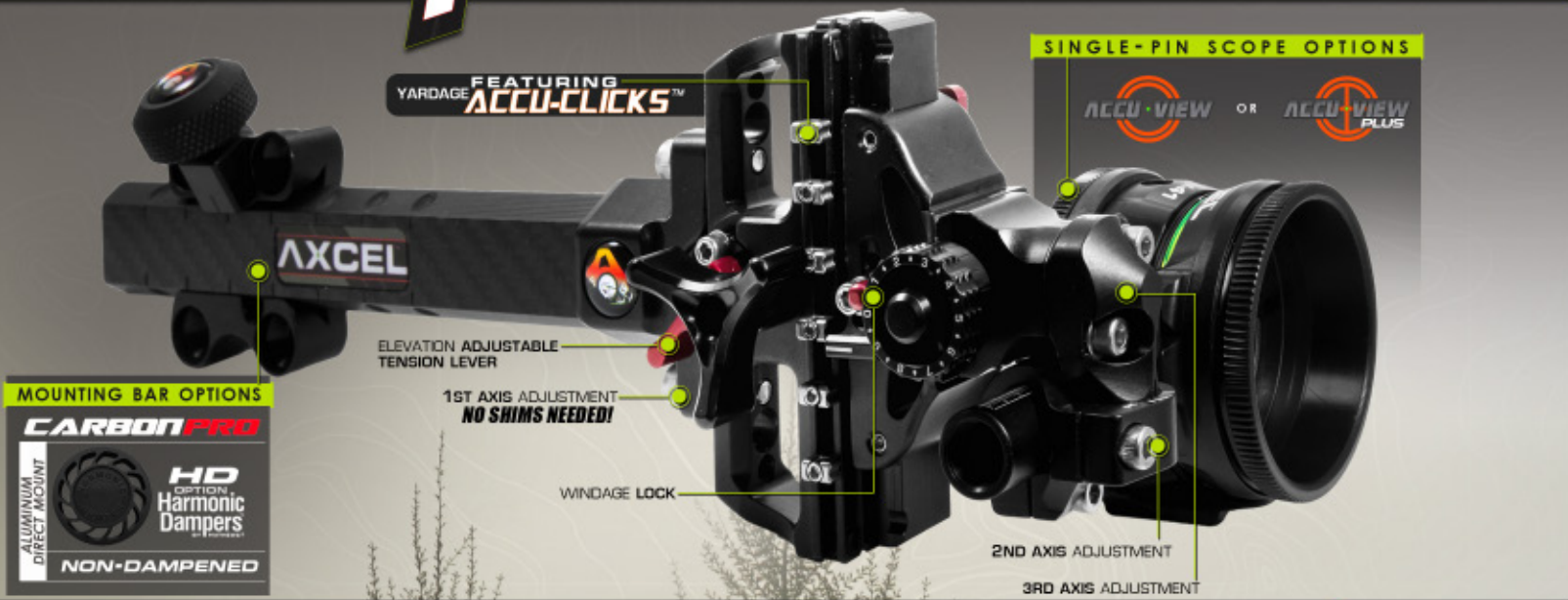

SINGLE-PIN SCOPE OPTIONS

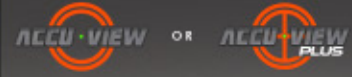

ACCUTOUCH



ALSO AVAILABLE WITH AN AV31 SCOPE
SEE PAGE 18-19 FOR MORE INFORMATION



ACCUTOUCH PLUS



ALSO AVAILABLE WITH AN AV31 SCOPE
SEE PAGE 18-19 FOR MORE INFORMATION

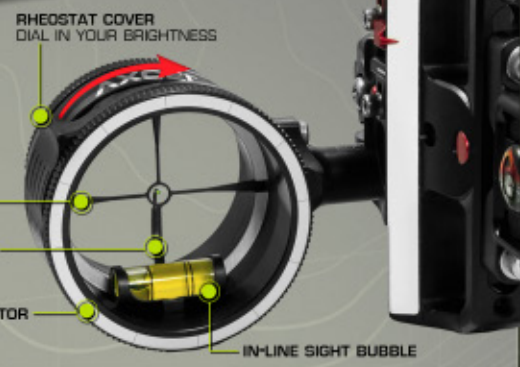
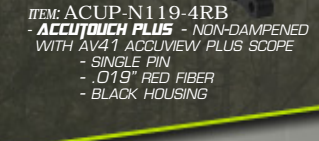
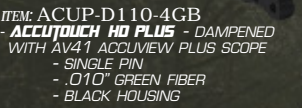

SEE PAGE 18-19 FOR MORE INFORMATION

SEE PAGE 18-19 FOR MORE INFORMATION

SET-UP OPTIONS



PIN OPTIONS

| | | | |
|--|---|----------------|----------------|
| *WHITE SIGHT LIGHTS CAN BE USED FOR GREEN, RED, AND YELLOW | *BLUE FIBER REQUIRES A BLUE SIGHT LIGHT | BLUE (BL) | RED (RD) |
| GREEN (GR) | YELLOW (YL) | .019" or .010" | .019" or .010" |

OPTIONAL EXTRAS

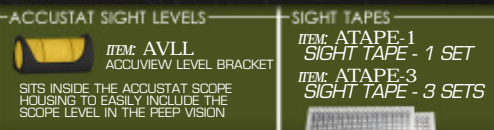

ACCUTOUCH

MULTI-PIN SLIDER SIGHT WITH ACCU-STAT SCOPE

1" OF VERTICAL TRAVEL

- LOWER PIN CHASER = DESIGNED FOR LONGER DISTANCE SHOOTING
- MIDDLE PIN CHASER = DESIGNED FOR ACCURACY BY KEEPING THE PIN IN THE MIDDLE OF HOUSING



CHOOSE YOUR SCOPE



CHOOSE MOUNTING BAR

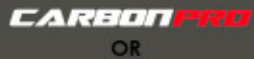

THE AXCEL RING PIN INCORPORATES FEATURES WHICH ARE LICENSED UNDER U.S. PATENT NO. RE39,686 TO K-HSH-NOOD



45° REAR FADING SIGHT TAPE

CARBON BAR SUPERIOR FEATURES

- ▶ EYE-APPEALING CARBON WOVEN MATERIAL
- ▶ VIBRATION ABSORPTION
- ▶ MATERIAL STIFFNESS
- ▶ HIGH STRENGTH-TO-WEIGHT RATIO

ITEM: ACUT-C510-4BK - ACCUTOUCH CARBON PRO
- WITH ACCU-STAT SCOPE - 41MM HOUSING - 5 PIN - .010" FIBERS



ITEM: ACUT-D310-4BK - ACCUTOUCH DAMPENED
- WITH ACCU-STAT SCOPE - 41MM HOUSING - 3 PIN - .010" FIBERS



ITEM: ACUT-N310-4BK - ACCUTOUCH NON-DAMPENED
- WITH ACCU-STAT SCOPE - 41MM HOUSING - 3 PIN - .010" FIBERS

ORDERING INSTRUCTIONS FOR ALL ACCUTOUCH SIGHTS:

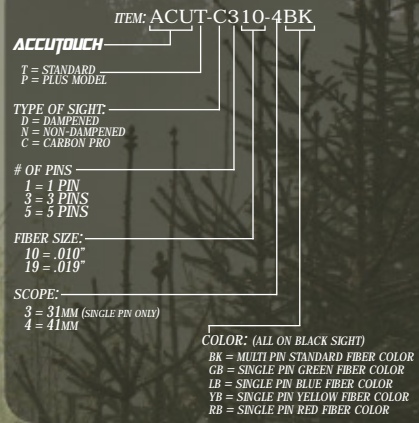

ACCU-STAT SCOPES

THE ACCU-STAT SCOPE IS THE PREMIERE MULTI-PIN MICRO-ADJUSTABLE HOUSING THAT WILL FIT ON TO ANY AXCEL™ SIGHT WITH A 2ND AND 3RD AXIS REMOVABLE BLOCK. THIS INCLUDES THE ACCUTOUCH, ACHIEVE OR AX SERIES SIGHTS, OFFERED IN THREE AND FIVE PIN CONFIGURATIONS, WITH A CHOICE OF 0.010 OR 0.019 PIN SIZES, OR WITH THE COLOR OPTIONS OF GREEN, RED, BLUE AND YELLOW. THE ACCU-STAT SCOPE HAS A VOID IN THE ENGRAVING AT THE CENTER OF THE SCOPE FOR THOSE ARCHERS THAT CHOOSE TO USE THEIR CHASER PIN IN THE EXACT MIDDLE OF THE HOUSING. THE ACCU-STAT MICRO-ADJUSTABLE PINS WORK SIMILARLY TO THAT OF THE POPULAR ARMORTECH HUNTING SIGHT, WHERE YOU CAN LOOSEN ONE OR MULTIPLE PINS FOR MOVING AT A TIME. ON THE ACCU-STAT SCOPE YOU WILL FIND A RHEOSTAT FIBER COVER THAT ALLOWS THE ARCHER TO ADJUST THE BRIGHTNESS OF THE PINS. THE ACCU-STAT ALSO WILL ACCEPT A RHEOSTAT SIGHT LIGHT. THE 1 3/4" HOUSING HAS 24" OF FIBERWEAVING ALL THE WAY AROUND THE SCOPE. THE ACCU-STAT WILL ALSO FEATURE A LEVEL BUBBLE, WHERE THE BUBBLE AND BUBBLE HOUSING ARE WITHIN THE CIRCUMFERENCE OF THE HOUSING. ALL ACCU-STAT SCOPES WILL COME WITH A LARGE BUBBLE.



ITEM: ACUT-S319-4BK
- ACCU-STAT SCOPE WITH YCS CONNECTION SYSTEM
- 3 PINS - .019" FIBERS - BLACK

- * STANDARD * GREEN SET-UP * GREEN

*S0 (SPECIAL ORDER) SIGHTS AVAILABLE CALL FOR PRICING



ITEM: ACUT-S519-4BK
- ACCU-STAT SCOPE WITH YCS CONNECTION SYSTEM
- 5 PINS - .019" FIBERS - BLACK

- * STANDARD * GREEN SET-UP * RED * YELLOW * RED * GREEN

*S0 (SPECIAL ORDER) SIGHTS AVAILABLE CALL FOR PRICING



YARDAGE ACCUCLICKS

PACK OF 5 OR SOLD SINGLY

ITEM: ACUT-CLK5
- ACCUTOUCH ACCU-CLICK™ - 5 PACK

ITEM: ACUT-CLK1
- ACCUTOUCH ACCU-CLICK™ - SINGLE

ACCU-STAT RHEOSTAT COVER

REPLACEMENT ACCU-STAT RHEOSTAT COVER.

ITEM: ACUT-RC-BK

SLIDER WINDAGE OFFSET ACCU-STAT SLIDER WINDAGE OFFSET BRACKET

ITEM: ACUT-WOB

2ND AXIS OFFSET BLOCK

ACCU-STAT SECOND AXIS OFFSET BRACKET

ITEM: ACUT-OB

ACCUTOUCH MAGNIFIER SIGHT SCALE

ITEM: ACUT-MSW-BK
WIDE SIGHT SCALE

ARMORTECH

THE **ARMORTECH-HD** WAS VOTED BEST BUY WINNER, FROM INSIDE ARCHERY MAGAZINE, FOR 3 YEARS STRAIGHT! THE **ARMORTECH** AND **ARMORTECH-HD** PACKS A PUNCH WITH ITS SUPERIOR PATENTED TECHNOLOGY, INNOVATIVE DESIGN, AND DEADLY ACCURACY. FEATURES PINS THAT ARE MACHINED TO EXACT TOLERANCES IN OUR USA MACHINE SHOP AND AN INNOVATIVE SCOPE DESIGN **T.C.V.** (TRUE CENTER VISION). ALL **ARMORTECH** AND **ARMORTECH-HD** SIGHTS ARE AVAILABLE WITH 4, 5, OR 7 PINS IN .010", .019" OR .029" (WHILE SUPPLIES LAST) FIBER SIZE. ALSO AVAILABLE WITH THE MATHEWS® HARMONIC DAMPER OPTION (**ARMORTECH-HD** MODEL).

MATHEWS® HARMONIC DAMPER™ IS A TRADEMARK OF MATHEWS, INC.

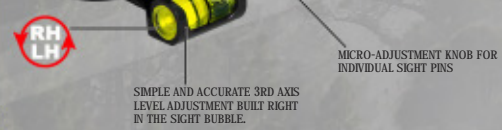

PIN / FIBER OPTIONS

SPECIAL ORDER
COLOR COMBINATIONS CAN BE SPECIAL ORDERED FOR AN ADDITIONAL CHARGE ON ALL **ARMORTECH** MODELS
ADD: SO TO CODE CALL FOR PRICING

RIGHT PIN
4 PINS | 5 PINS | 7 PINS

FIBER SIZE
.010" | .019" | .029"
*WHILE SUPPLIES LAST

| ARMORTECH HUNTING SIGHTS | ELEVATION | WINDAGE | TRAVEL |
|--------------------------|--------------------------|--------------------------|----------|
| | 20 CLICKS PER REVOLUTION | 20 CLICKS PER REVOLUTION | 0.00156" |

ARMORTECH-HD

SHOWN

ITEM: AXAT-D519-BK

ORDERING INSTRUCTIONS: *SO (SPECIAL ORDER) SIGHTS AVAILABLE CALL FOR PRICING

AT FOR FIXED MOUNT SIGHT
AP FOR PRO DOVETAIL

ITEM: AXAT-D419-BK

ARMORTECH

DAMPENED/NON-DAMPENED
D = DAMPENED
N = NON-DAMPENED

FIBER SIZE:
10 = .010"
19 = .019"
29 = .029"
*NOT AVAILABLE WITH HS OPTION
NOTE: HS AND .029" FIBER SIZE ARE WHILE SUPPLIES LAST

NUMBER OF PINS:
4 = 4 PINS
5 = 5 PINS
7 = 7 PINS

CODE GUIDE:
HD = MATHEWS® HARMONIC DAMPER™
HS = HIGH SPEED PINS
PRO = SLIDER BAR



SLIDER BAR PRO MOUNT
DIRECT MOUNT



ARMORTECH ACCESSORIES

SIGHT LIGHT



SIGHT PIN PIVOT LOCK
ENGINEERED TO NOT VIBRATE LOOSE

DO NOT OVER TIGHTEN OR DAMAGE WILL RESULT

MICRO ADJUST MICRO ADJUST EACH PIN

RH/LH INTERCHANGEABLE RH/LH

5 PIN ADJUSTABLE 2ND / 3RD AXIS

ENGRAVED PARTIAL RING
AT DEPTH OF SIGHT PINS, DESIGNED FOR GREATER ACCURACY WHEN VIEWED SLIGHTLY OFF CENTER

CCCT
CO-PLANAR CENTERING TECHNOLOGY

ARMOR FIBER TECHNOLOGY
PROVIDES PROTECTION TO FIBERS THAT RUN THROUGH CLEAR PROTECTIVE SHIELD

TRUE CENTER
T.C.V. IS PROVIDED DUE TO THE "HOOR-GLASS" OR "VENTURI" SHAPE INSIDE SCOPE WHICH SUPPLIES A CIRCULAR SIGHT PICTURE REFERENCE EVEN WHEN VIEWED SLIGHTLY OFF-CENTER.

VIEW ANGLE 5 DEGREES

INFERIOR TUBE SHAPE SCOPE (INCREASED)

AXCEL TRUE CENTER VISION

LOST VISION

TORQUE INDICATOR

VIEW ANGLE 5 DEGREES

ARMORTECH VISION

BRINGING NEW TECHNOLOGY TO A MARKET THAT ASKS, "WHAT MORE CAN BE DONE?" THE AXCEL™ ARMORTECH-HD VISION AND ARMORTECH VISION OFFERS A 2" HOUSING FOR OPTIMAL VIEW OF YOUR TARGET. IT BRINGS NEW MEANING TO "SEEING IS BELIEVING!" CONTINUING THE TOUGH AS A TANK ATTITUDE FOUND IN THE ORIGINAL ARMORTECH, WITH THE SAME ENGINEERING AND TOP FEATURES USED THROUGH THE ENTIRE ARMORTECH SERIES. THE INNOVATIVE LINE OF AXCEL™ ARMORTECH VISION AND THE ARMORTECH-HD VISION ARE, BY FAR, AN ENGINEERING MARVEL. "SET YOUR SIGHTS ON AXCEL™!"

2"
SCOPE HOUSING



ARMORTECH VISION-HD PRO
5 PINS | .019" FIBERS | BLACK | HD OPTION Harmonic Dampers

UNIVERSAL QUIVER MOUNT
INCLUDED WITH PRO SIGHTS, BUT ALSO SOLD SEPARATELY.

ITEM: AVAP-D519-BK



ARMORTECH VISION PRO
ITEM: AVAP-N419-BK

ORDERING INSTRUCTIONS:

ITEM: AVAT-D519-BK

ARMORTECH VISION

COLOR: BK = BLACK

DAMPENED/NON-DAMPENED
D = DAMPENED
N = NON-DAMPENED

NUMBER OF PINS:
4 = 4 PINS
5 = 5 PINS
7 = 7 PINS

FIBER SIZE:
10 = .010"
19 = .019"
29 = .029"

*SO (SPECIAL ORDER) SIGHTS AVAILABLE CALL FOR PRICING

AT FOR FIXED MOUNT SIGHT
AP FOR PRO MOUNT DOVETAIL SIGHT
HS FOR HS (HIGH-SPEED) OPTION - FIXED MOUNT
HP FOR HS (HIGH-SPEED) OPTION - PRO MOUNT
*WHILE SUPPLIES LAST

NOTE: HS AND .029" FIBER SIZE ARE WHILE SUPPLIES LAST

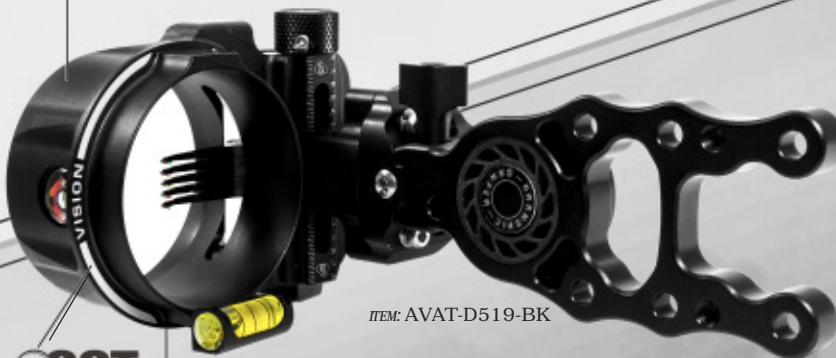

ITEM: AVAT-D519-BK

CCCT
CO-PLANAR CENTERING TECHNOLOGY

ARMORTECH VISION-HD
5 PINS | .019" FIBERS | BLACK | HD OPTION

LEADING TECHNOLOGY, PROVEN RESULTS

VERTICAL OFFSET BLOCK
FITS: ARMORTECH, RHEOTECH AND ACCOUTOUCH

ITEM: AXAT-VOB
-GAINS EXTRA 9/16" OF ELEVATION ADJUSTMENT (UP OR DOWN)

ARMORTECH SERIES SIGHT LEVELS
KEEPS THE BUBBLE OUTSIDE THE CIRCUMFERENCE OF THE SCOPE HOUSING, MAINTAINING THE VENTURI SHAPE.

STANDARD LEVEL BRACKETS
SMALL LEVEL BRACKET
ITEM: AXSL
6 MM LEVEL BRACKET

LARGE LEVEL BRACKET
ITEM: AXLL
8 MM LEVEL BRACKET

TALL LEVEL BRACKETS
SMALL LEVEL BRACKET - TALL
ITEM: AXST
6 MM TALL LEVEL BRACKET

LARGE LEVEL BRACKET - TALL
ITEM: AXLT
8 MM TALL LEVEL BRACKET

QUIVER MOUNT BRACKET
QUIVER MOUNT BRACKET ATTACHES TO MOUNTING BRACKET OF PRO EXTENSION BAR AND MAKES MOUNTING YOUR QUIVER A SIMPLE TASK.

ITEM: AXQB

ARMORTECH CONVERSION KITS
CONVERT ANY ARMORTECH SIGHT INTO A PRO MODEL OR ANY PRO MODEL INTO A REGULAR ARMORTECH MODEL WITH THESE CONVERSION KITS. AVAILABLE WITH OR WITHOUT MATHEWS' HARMONIC DAMPER.

ARMORTECH-HD CONVERSION KIT
ITEM: AXAT-CKKT
- NON-DAMPENED

ARMORTECH-HD CONVERSION KIT
ITEM: AXAT-CDKT
- DAMPENED

ARMORTECH PRO CONVERSION KIT
ITEM: AXAP-CKKT
PRO MODEL - NON-DAMPENED

ARMORTECH-HD PRO CONVERSION KIT
ITEM: AXAP-CDKT
PRO MODEL - DAMPENED

PRO CONVERSION KIT INCLUDES HARDWARE AND QUIVER MOUNT.

ITEM: AXAT-LF
1-3/4" FRAME ONLY - WILL NOT FIT ON ARMORTECH VISION

ITEM: AXAT-LF-SET
1-3/4" AND 43MM FRAMES ONLY - WILL NOT FIT ON ARMORTECH VISION

ITEM: AXAT-LR
LENS RETAINER
LENS RETAINER ONLY - WILL NOT FIT ON ARMORTECH VISION

ITEM: AXAT-HLR
HOODED LENS RETAINER
1-3/4" FRAME ONLY - WILL NOT FIT ON ARMORTECH VISION

ITEM: AXAT-2XRC
COMES WITH LENS, LENS FRAME, AND REGULAR RETAINER 1-3/4" FRAME ONLY - WILL NOT FIT ON ARMORTECH VISION

ITEM: AXAT-2XHC
COMES WITH LENS, LENS FRAME, AND HOODED RETAINER 1-3/4" FRAME ONLY - WILL NOT FIT ON ARMORTECH VISION

REPLACE:
2X FOR 2 POWER LENS
4X FOR 4 POWER LENS
6X FOR 6 POWER LENS
8X FOR 8 POWER LENS

RHEOTECH

FIXED PIN SIGHT

ROCK SOLID DEPENDABILITY

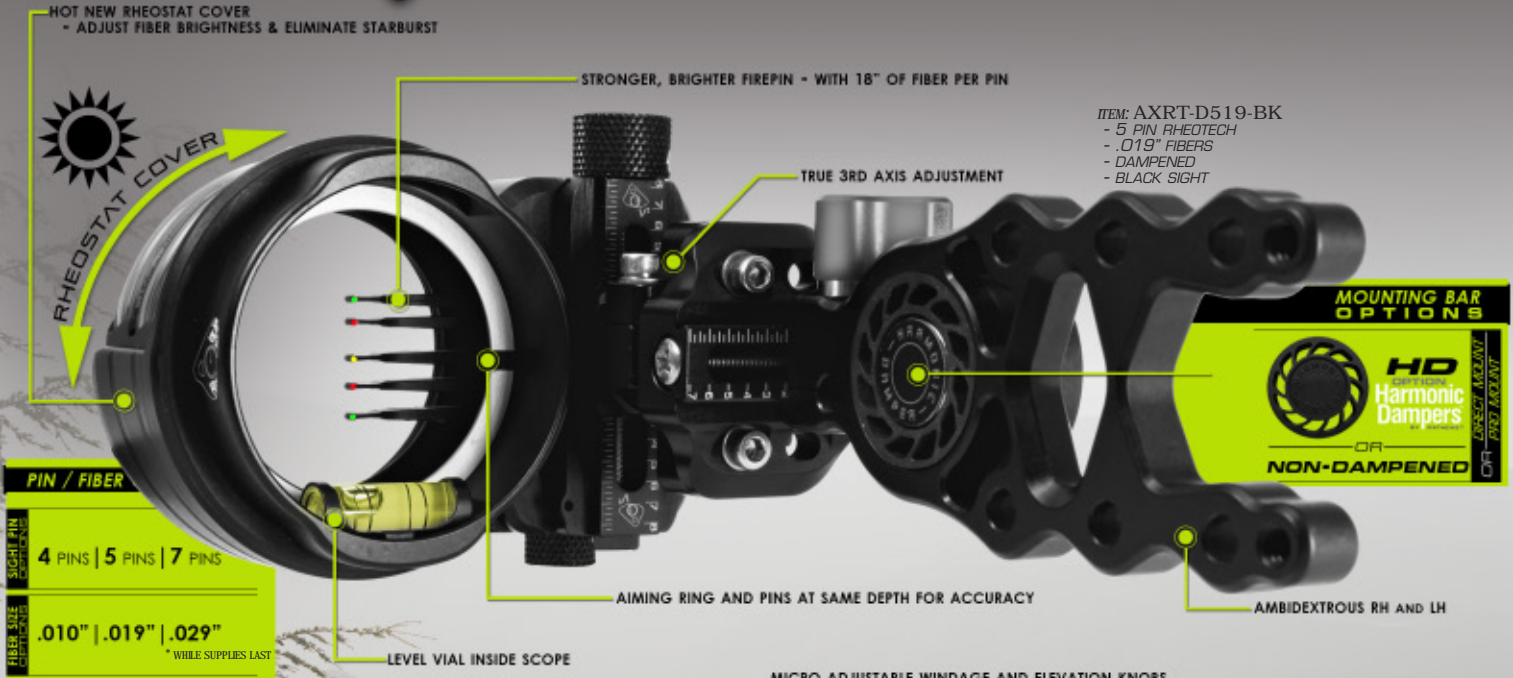

RHEOTECH PRO

FEATURING A DOVE TAIL BAR WITH OR WITHOUT DAMPER



ORDERING INSTRUCTIONS:
ITEM: AXRP-D5 19-BK

RHEOTECH

BAR TYPE:
P = PRO MOUNT
T = DIRECT MOUNT

TYPE OF SIGHT:
D = DAMPENED
N = NON-DAMPENED

OF PINS
4 = 4 PIN
5 = 5 PINS
7 = 7 PINS

FIBER SIZE:
10 = .010"
19 = .019"

SIGHT COLOR
(BLACK ONLY)

ACCUHUNTER SLIDER SIGHT

ITEM: ACHN-N110-4GB
AVHUNTER EQUIPPED
 - 41MM HOUSING - 1 PIN
 - .010" FIBERS - GREEN FIBER
 - BLACK SIGHT

ACCEL™ SIGHTS DROPS A BOMBHELL ON THE COMPETITION WITH THE INTRODUCTION OF THE NEW ACCUHUNTER AND ACCUHUNTER PLUS SINGLE PIN SLIDER SIGHT FEATURING THE AV HUNTER SCOPE. WITH A PRICE AIMED AT THE MID-LEVEL HUNTERS, HIGH QUALITY REMAINS CONSISTENT TO ACCEL'S™ TOUGHEST STANDARDS. A SLEEK AND SOLID MOUNTING BRACKET AND ELEVATION BAR MAKE THE ACCUHUNTER A DEPENDABLE CHOICE AMONG THE HARDEST OF HUNTERS. SUPERIOR FEATURES INCLUDE THAT OF INDIVIDUAL ELEVATION AND WINDAGE LOCKS, AN ADJUSTABLE 20 YARD DEAD STOP, GREEN ACCENTS AND A NEW AV HUNTER SCOPE, SPECIFICALLY DESIGNED FOR THE ACCUHUNTER SIGHT. THE AV HUNTER SCOPE FEATURES OUR NEW FIREPIN AND A NEW METHOD OF FIBER WRAPPING TECHNOLOGY, CREATING ONE OF THE BRIGHTEST FIBER OPTIC PINS TO HIT THE MARKET. THE AV HUNTER SCOPE HAS A 1 3/4" SIZED HOUSING AND ACCEPTS ALL THE SAME ACCEL™ SCOPE ACCESSORIES AVAILABLE FOR THE AV41" SIZED SCOPES. THE ACCUHUNTER PLUS CONTAINS THE NEW "PLUS" SCOPE OPTIONS: CONTAINING THE CROSSHAIR INSERT, RHEOSTAT COVER AND TORQUE RING INDICATOR, WHICH IS IN ADDITION TO ALL THE STANDARD PARTS ON THE AV HUNTER SCOPE. ALL ACCUHUNTER, ACCUHUNTER PLUS, AND AV HUNTER SCOPES CAN BE TRANSFORMED INTO RIGHT OR LEFT HAND DEXTERITY WITH NO ADDITIONAL PARTS.—



FIREPIN IS SOLD INDIVIDUALLY, SOLD WITH AVHUNTER / AVHUNTER PLUS SCOPE MODELS, OR INCLUDED ON ACCUHUNTER / ACCUHUNTER PLUS SIGHTS

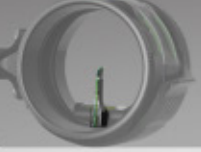

AVHN-FP10-COLOR
 .010" FIBER + COLOR CHOICE
AVHN-FP19-COLOR
 .019" FIBER + COLOR CHOICE
 AVAILABLE FIBER COLOR:
 GREEN(GR), RED(RD), BLUE(BL), AND YELLOW(YL)

AVHUNTER SCOPE EQUIPPED

AV HUNTER SCOPES ARE INCLUDED WITH THE ACCUHUNTER SIGHTS AND ARE AVAILABLE SEPARATELY



45° REAR FACING SIGHT TAPE

1ST AXIS ADJUSTMENT
NO SHIMS NEEDED!

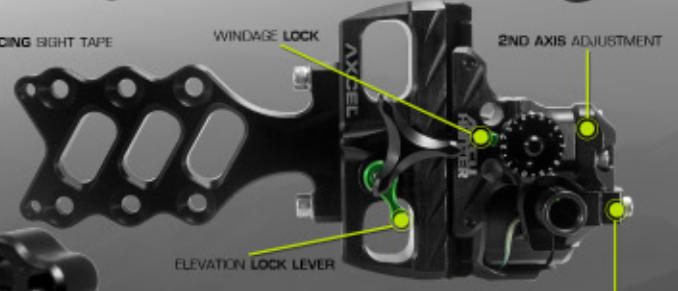

WINDAGE LOCK

2ND AXIS ADJUSTMENT

ELEVATION LOCK LEVER

3RD AXIS ADJUSTMENT

ACCUHUNTER PLUS

ITEM: ACHP-N119-4GB
AVHUNTER PLUS EQUIPPED
 - 41MM HOUSING - 1 PIN
 - .019" FIBER - GREEN FIBER
 - BLACK SIGHT



CROSSHAIR INSERT

RHEOSTAT COVER
 ALLOWS ARCHER TO ADJUST THE BRIGHTNESS OF THE PINS WHILE ELIMINATING STAR-BURSTING PINS

TORQUE RING INDICATOR

AVHUNTER PLUS SCOPE EQUIPPED

AV HUNTER PLUS SCOPES ARE INCLUDED WITH THE ACCUHUNTER PLUS SIGHTS AND ARE AVAILABLE SEPARATELY

ORDERING INSTRUCTIONS FOR ALL ACCUHUNTER SIGHTS:

ITEM: ACHP-N119-4GB
 ACCUHUNTER
 SCOPE MODEL:
 N = FEATURES AV HUNTER SCOPE
 P = FEATURES AV HUNTER PLUS SCOPE
 TYPE OF SIGHT/NUMBER OF PINS:
 N1 = NON-DAMPENED SINGLE PIN
 FIBER SIZE:
 10 = .010"
 19 = .019"
 PIN COLOR/ SIGHT COLOR:
 GB = GREEN PIN/BLACK SIGHT
 LB = BLUE PIN/BLACK SIGHT
 RB = RED PIN/BLACK SIGHT
 YB = YELLOW PIN/BLACK SIGHT
 SCOPE SIZE:
 4 = 41MM SCOPE HOUSING

AV HUNTER SCOPES AND ACCESSORIES

AVHUNTER SCOPE BUNDLES

- ITEM: AVHN-TPLUS10GR-BK
 PLUS SCOPE WITH .010" GREEN FIREPIN
- ITEM: AVHN-TPLUS19GR-BK
 PLUS SCOPE WITH .019" GREEN FIREPIN
- ITEM: AVHN-T10GR-BK
 SCOPE WITH .010" GREEN FIREPIN
- ITEM: AVHN-T19GR-BK
 SCOPE WITH .019" GREEN FIREPIN

AVHUNTER PLUS SCOPE



AVHUNTER SCOPE

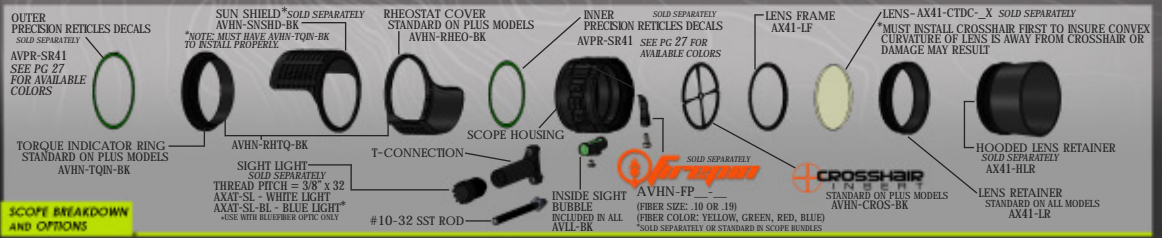

NEW 2019

DIRTY TRUCKER HAT



ITEM: HATS-MESH-DI

ITEM: AHATS-MESH-DI

WRIST BANDS

ITEM: BAND
SINGLE WRIST BAND

ITEM: BAND-VAR
WRIST BAND VARIETY PACK (PACK OF 6PCS)
A RANDOM SELECTION OF 6 T.R.U. BALL™ AND AXCEL™ RUBBER WRIST BANDS. COLOR CHOICES VARY, AND THE PACK OF 6 PIECES IS RANDOMLY SELECTED.



BANNER ITEM: BANR-RS SIZE: APPROX 5' x 3'



DECALS



ITEM: TDECL AVAILABLE SIZES:
24" -ITEM: TDECL-24
16" -ITEM: TDECL-16
10" -ITEM: TDECL-10



ITEM: CDECL-10 AVAILABLE SIZES: 10"



ITEM: ADECL AVAILABLE SIZES:
24" -ITEM: ADECL-24
16" -ITEM: ADECL-16
10" -ITEM: ADECL-10

T-SHIRTS



MADE IN USA T-SHIRT

ITEM: CSHIRT-BK
PRE-SHRUNK
MEN'S SIZES (XS,S,M,L,XL,XXL,XXXL)



BEAST T-SHIRT

ITEM: TSHIRT-BK
BLACK 100% COTTON
PRE-SHRUNK, MEN'S SIZES
(S,M,L,XL,XXL,XXXL)



T.R.U. LONG SLEEVE T-SHIRT

ITEM: LSHIRT
FEATURING A EUROPEAN MOUNT ALONG WITH T.R.U. BALL™ ACROSS THE CHEST. ON THE BACK, "EST. 1995" IS WRITTEN WITH DESIGN. THE LEFT ARM FEATURES THE T.R.U. BALL™ RELEASE NAME. MEN'S SIZES (S,M,L,XL,XXL,XXXL)

S/S T-SHIRT BACK DETAIL



ACHIEVE T-SHIRT
ITEM: ASHIRT-WH
WHITE 100% COTTON
PRE-SHRUNK,
MEN'S SIZES
(S,M,L,XL,XXL,XXXL)



TOUGH AS A TANK T-SHIRT
ITEM: ASHIRT-GY
GREY 100% COTTON PRE-SHRUNK,
MEN'S SIZES (S,M,L,XL,XXL,XXXL)

* ALL HATS ONE SIZE FITS MOST

HOODIES

PRE-SHRUNK,
MEN'S SIZES
(S,M,L,XL,XXL)



T.R.U. FLEECE HOODIE
ITEM: HOOD-FL-BK
BLACK BLUE
PRE-SHRUNK



AXCEL FLEECE HOODIE
ITEM: AHOOD-FL-BL
ROYAL BLUE
PRE-SHRUNK

NEW 2019

PREMIUM T-SHIRTS



T.R.U. T-SHIRT
ITEM: TSHIRT-BL
BLUE PRE-SHRUNK,
MEN'S SIZES
(S,M,L,XL,XXL,XXXL)



AXCEL T-SHIRT
ITEM: ASHIRT-BK
BLACK PRE-SHRUNK,
MEN'S SIZES
(S,M,L,XL,XXL,XXXL)



VEST AND JACKET
100% POLYESTER, PRE-SHRUNK
MEN'S SIZES (S,M,L,XL,XXL,XXXL)

KNIT BEANIES
THIS BEANIE IS SNUG TO THE HEAD AND EARS TO KEEP HEAT IN. 100% ACRYLIC YARN. (ONE SIZE FITS MOST)



ITEM: BEANIE-M-BK

ITEM: ABEANIE-M-BK

SHOOTER SHIRTS



FLAME SHOOTER SHIRT

ITEM: SSHIRT-FL
100% POLYESTER,
(XS,S,M,L,XL,XXL,XXXL)



BLACK SHOOTER SHIRT

ITEM: SSHIRT-BK
100% POLYESTER,
(XS,S,M,L,XL,XXL,XXXL)



RED SHOOTER SHIRT

ITEM: SSHIRT-RD
100% POLYESTER,
(XS,S,M,L,XL,XXL,XXXL)

HATS



ITEM: HATS-MESH-COLOR CHOICE

- A. WOODLAND CAMO/TAN MESH HAT (DA)
- B. BLACK/TAN MESH HAT (BK)
- C. ORANGEB/TAN MESH HAT (DR)
- D. RED/TAN MESH HAT (DR)
- E. BLUE/TAN MESH HAT (BL)
- F. PINK/TAN MESH HAT (PK)

ITEM: AHATS-MESH-COLOR CHOICE

- G. BLACK MESH HAT (BK)
- H. BLUE MESH HAT (BL)

ITEM: HATS-OTA-COLOR CHOICE

- I. BURGUNDY/SILVER MESH (DB)
- J. NAVY/SILVER MESH (NS)

ITEM: CHATSEZ-WH

ITEM: VISORS-MESH

ITEM: HATS-FLAT-BK

ITEM: AHATS-FLAT-BK

FLAT BRIM HATS

STRUCTURED HAT FEATURES A HIGH CROWN, FLAT BRIM, AND SNAPBACK CLOSURE

KRYPTEK HAT
ITEM: HATS-KRP

REPLACEMENT STRAPS SUPERIOR NEOPRENE COMFORT



T.R.U. BALL® VELCRO® AND BUCKLE STRAPS FEATURE COMFORTABLE NEOPRENE PADDING, ADDING SUPERIOR COMFORT TO OUR DURABLE STRAPS



BUCKLE STRAP FEATURES BUILT-IN BELT LOOP STRAP

CINCH STRAPS

FITS: SHORT-N-SWEET® R S1, SHORT-N-SWEET® R S2, EXECUTE WEB, COPPERHEAD WEB

ITEM: TCSB-BK
- BLACK LEATHER BUCKLE STRAP

ITEM: TCSV-CA
- CAMO VELCRO® STRAP

FEATURING
CINCH
TECHNOLOGY

TORNADO CONNECTION (TC) STRAPS

FITS: COPPERHEAD TC AND EXECUTE TC

ITEM: TTCB-BK-5L
- EXECUTE TC 5-HOLE EXTENSION
- BLACK LEATHER BUCKLE STRAP

ITEM: TTCB-BK-8L
- COPPERHEAD TC 8-HOLE EXTENSION
- BLACK LEATHER BUCKLE STRAP

PLUS/STINGER STRAPS

FITS:
STINGER, SHOOTER, FANG RC, BONE COLLECTOR™ BANDIT, BANDIT, PLUS STRAPS AND V-LOCKS
NOTE:
BLACK VELCRO® AVAILABLE (TSTP-BK)

ITEM: TSBP-BK
- BLACK LEATHER BUCKLE STRAP

ITEM: TSTP-CA
- CAMO VELCRO® STRAP

WEB STRAPS

FITS:
FANG, ASSASSIN SCOUT AND BONE COLLECTOR™ SCOUT
NOTE:
BLACK VELCRO® AVAILABLE (TWSV-BK)

ITEM: TWSV-CA
- CAMO VELCRO® STRAP

ITEM: TWSB-BK
- BLACK LEATHER BUCKLE STRAP

GLOBO-SWIVEL STRAPS

FITS:
BEAST XT 1, BEAST XT 2, ASSASSIN XT, ASSASSIN, BONE COLLECTOR™ ASSASSIN, BONE COLLECTOR™ BEAST, AND FANG GS
NOTE: BLACK VELCRO® AVAILABLE (TGBV-BK)

ITEM: TGBB-BK
- BLACK LEATHER BUCKLE STRAP

ITEM: TGBV-CA
- CAMO VELCRO® STRAP

PREDATOR STRAPS

FITS: PREDATOR *WHILE SUPPLIES LAST

ITEM: TPSV-CA
- CAMO VELCRO® STRAP

ITEM: TPSB-BK
- BLACK LEATHER BUCKLE STRAP

T.R.U. BALL® WRIST STRAP SIZING CHART SIZING RELATES TO APPROXIMATE DISTANCE AROUND THE WRIST

VELCRO® STRAP

| | SHORTEST | LONGEST |
|--------------|----------|---------|
| JUNIOR (JR) | 6 | 7 3/4" |
| LARGE (LG) | 6 | 8 1/4" |
| X-LARGE (XL) | 7 | 9 1/2" |

BUCKLE STRAP

| | SHORTEST | LONGEST |
|-------------|----------|---------|
| JUNIOR (JR) | 5 1/4" | 7 3/4" |
| LARGE (LG) | 6 | 10 |

CLICKERS

ITEM: HTSD-F
- HT SPEED DIAL SEAR CLICKER - FAST
F (FAST) OR R (REGULAR)

ITEM: TFLF-SC-1F
- FULKRUM FLEX SEAR CLICKER - 1● FAST
1F (● FAST), 2R (●● REGULAR),
3S (●●● SLOW), OR ON (NO DOT/NO CLICK)

ITEM: TGOT-SC
- GOAT SEAR CLICKER
1F (● FAST) OR 2R (●● REGULAR)

MULTI-POSITION OFFSET TRIGGER THUMB BARREL

OFFSET KNURLED THUMB PIN [5/8"]
AS SEEN ON THE GOAT RELEASE

ITEM: TKTP-O

NEW
2019

T.R.U. NOK

A CNC-MACHINED ANODIZED ALUMINUM LOOP THAT ENDS NOCK PINCH. THE ROUNDED LOOP STOPS UNSAFE JAW HANG-UP AND GIVES A CLEANER, MORE ACCURATE SHOT.

*INTENDED FOR USE WITH CALIPER-STYLE JAWS.

ITEM: TRUN - T.R.U. NOK

T.R.U. BALL® TRIGGERS

THE INCREDIBLE TRIGGER *WHILE SUPPLIES LAST

SUPERIOR MICRO-ADJUSTABLE THUMB BARREL. THE INCREDIBLE TRIGGER EXTENDS IN AND OUT IN 1/16" INCREMENTS, ROTATES 360°, AND PIVOTS 16° AT POINT OF ATTACHMENT.



ITEM: TKTP-IL
- LARGE - WITH 1/2" BARREL

ITEM: TKTP-IS
- SMALL - WITH 1/4" BARREL

ABYSS EXTENSION

ITEM: TABY-EXT-2L
- LARGE - WITH 1/2" BARREL

ITEM: TABY-EXT-2S
- SMALL - WITH 1/4" BARREL

SHOWN: TABY-EXT-2S

CUSTOMIZE YOUR HANDLE RELEASE AID FOR GREAT HUNTING AND SHOOTING RESULTS

ITEM: TKTP-S
- 1/4" BARREL

ITEM: TKTP-L
- 1/2" BARREL

ITEM: TKTP-A
- ANGLED THUMB PIN
3/8" BARREL

TEARDROP EXTENSION FOR TRIGGER

ITEM: TEARDROP
- EXTENSION FOR TRIGGER

T.R.U. BALL® RELEASE POUCH



ITEM: TRUB
- T.R.U. BALL® RELEASE POUCH

DUAL FLEECE COMPARTMENTS TO PROTECT YOUR RELEASES, WITH A DRAW STRING END TO KEEP TO KEEP EVERYTHING LOCKED IN.

-SOFT DUAL POCKET INTERIOR
-ZIPPERED POCKET
-DRAWSTRING
-BELT LOOP



T.R.U. BALL® V-LOCK STRAPS

V-LOCK STRAP ORDER INSTRUCTIONS:

- HANDLE MUST BE COMPATIBLE (MUST HAVE CUT-OUTS W/ STICKERS IN HANDLE)
- SPECIFY STRAP:
CAMO VELCRO®, BLACK VELCRO®, BLACK LEATHER BUCKLE, OR LANYARD
- SPECIFY HANDLES:
WIDE HANDLES CODE - SS
HBC | SWEET SPOT II | HT (M AND L)
THIN HANDLES CODE - TH
FANG 3 | FANG 4 | SWEET SPOT PRO

ITEM: VLKB-BK
- V-LOCK - BLACK LEATHER BUCKLE STRAP

ITEM: VLKV-CA
- V-LOCK - CAMO VELCRO® STRAP

ITEM: VLKL
- V-LOCK LANYARD

*DOES NOT INCLUDE ATTACHED RELEASES.

T.R.U. BALL® DRAWCHECK DEVICE

SAFELY PULL YOUR BOW TO TEST DRAW LENGTH, WITH THE DRAW CHECK THAT RESEMBLES MANY OF OUR POPULAR MODELS

ITEM: TDCV
- ORANGE VELCRO® STRAP

ITEM: TDCB
- ORANGE BUCKLE STRAP



SCOPE RING MASK

SPECIFY SCOPE SIZE:

- AV-41 GREEN - AVPR-SR41-GR
AV-31 PINK - AVPR-SR41-PI
AV-25 ORANGE - AVPR-SR41-OR
YELLOW - AVPR-SR41-YL
WHITE - AVPR-SR41-WH

SMALL REDUCER - BLACK
ITEM: AXPR-RDCS-BK

LARGE REDUCER - BLACK
ITEM: AXPR-RDCL-BK

SMALL DOT - BLACK
ITEM: AXPR-SMDT-BK

SMALL DOT - ORANGE
ITEM: AXPR-SMDT-OR

LENS RETICLE - GREY
ITEM: AXPR-LNRT-GY