

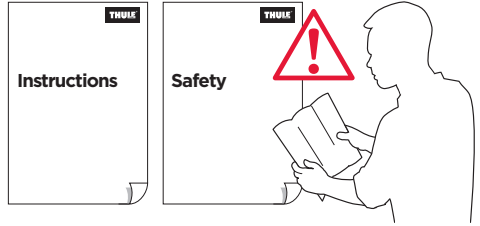



➤ Instructions

Thule Spring

11300103, 11300104, 11300102, 11300201, 11300205,
11300206, 11300207, 11300208





<p>MAX kg/lbs</p> 	<p>MAX</p> 	<p>MAX</p> <p>1,4 kg 3 lbs</p> <p>5 kg 11 lbs</p> 
<p>29 kg / 64 lbs</p>	<p>111 cm / 44"</p>	

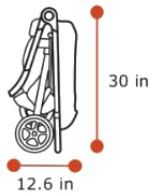
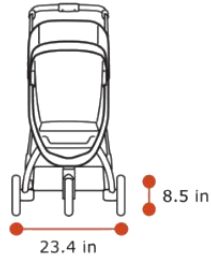
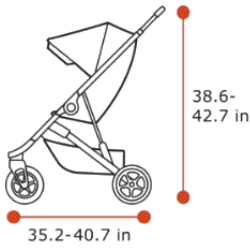

Congratulations

And thank you for choosing Thule Spring! You can rest assured that we have put all our efforts, knowledge and passion into designing the most stylish, flexible and safe stroller we could think of. We have also developed a wide range of accessories for you to personalize and make your strolls even more enjoyable. All so that you and your child are free to go wherever your curiosity takes you.

Before you use your Thule Spring, please read the following instructions carefully and keep them for future reference.

Let's go!

/Thule

WARNING:

- i1.** IMPORTANT - READ CAREFULLY AND KEEP FOR FUTURE REFERENCE. The child's safety may be affected if you do not follow these instructions.
- i2.** Read the Safety manual for Thule Strollers before use and keep for future reference.

The Thule Spring chassis and wheels can be cleaned with a damp cloth. Dry it with a dry cloth.

If wheels squeak, lubricate sparingly with silicone lubricant. Do NOT use oil or grease based products, as this will attract dirt, which will clog the movement.

Store your stroller and accessories in a dry area out of direct sunlight. Before storing your stroller, it should be dry to prevent the growth of mold or bacteria.

Maintenance

Keeping your Thule Spring stroller clean and well maintained is an important factor in keeping it in good condition.

Regularly inspect your stroller and accessories for damage and signs of wear:

- Check metal components for any dents or cracks. Do not use the stroller if any metal components are cracked or damaged.
- Examine the fabric regularly for tears, worn spots or any other signs of damage.

The fabrics on Thule Spring can be cleaned by hand.

- Spot clean or hand wash gently with mild soap & warm water. Do not use cleaning solvents.
- Rinse well with warm water.
- Hang to air dry completely.
- Do not machine wash! No bleach. Do not iron. Do not dry clean.
- If needed seat and canopy fabric can be removed for cleaning.

Features

1. Handlebar
2. Handlebar height adjustment button
3. Wrist strap
4. Canopy
5. Sun visor
6. Zipper for canopy extension and ventilation
7. Fold lock
8. Fold handle

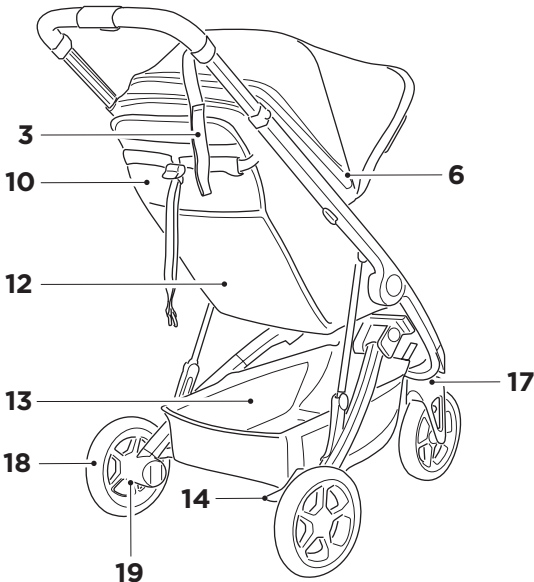
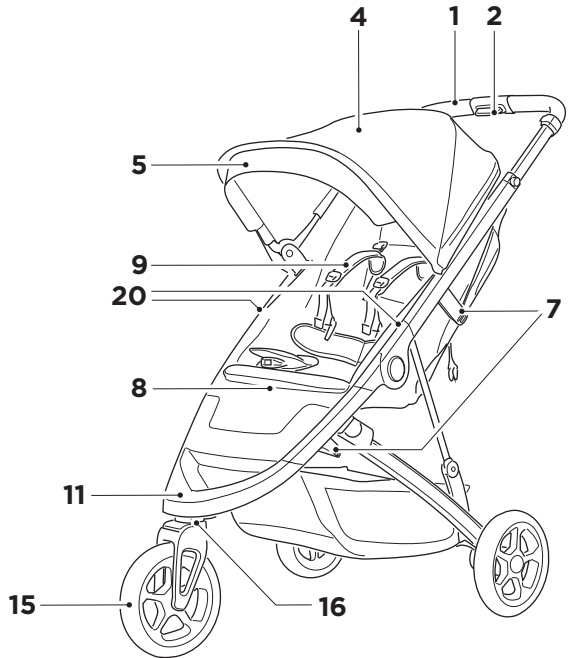

9. Harness
10. Reclining seat
11. Foot step
12. Mesh pocket
13. Basket
14. Parking brake
15. Swivel front wheel
16. Swivel wheel release button
17. Swivel lock/release switch
18. Rear wheel
19. Rear wheel release button
20. Accessory fixation points