

➤ Instructions

Thule Sleek Sibling Seat

11000200, 11000201, 11000202, 11000203, 11000204, 11000205,
11000206, 11000207

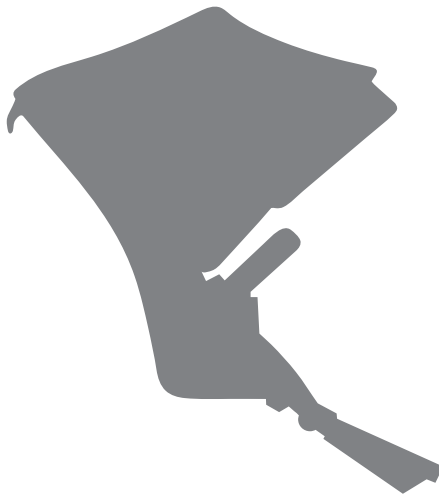





Sibling seat including rain cover, upper and lower adapters

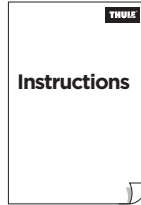





Thule Sleek Sibling Seat



MAX kg 	 15 kg + (15 kg)	 15 kg + (9 kg)
MAX kg 	5 kg	
MAX 	101 cm	



MAX lbs 	 33 lbs + (33 lbs)	 33 lbs + (20 lbs)
MAX lbs 	11 lbs	
MAX 	40"	



Approved configurations figuracije

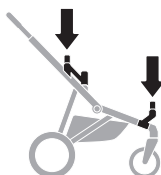
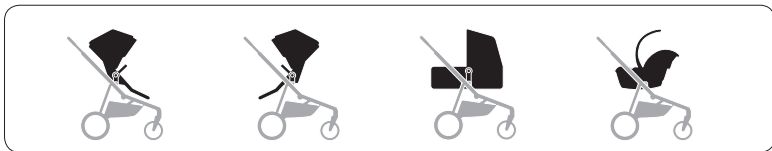

Not Approved configurations

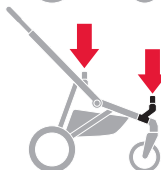
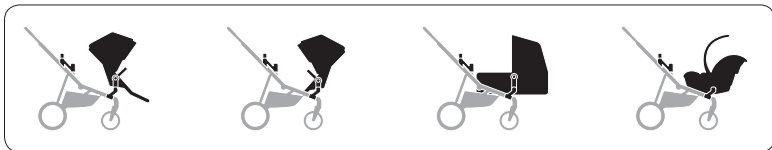
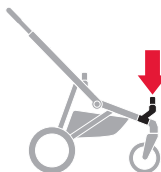
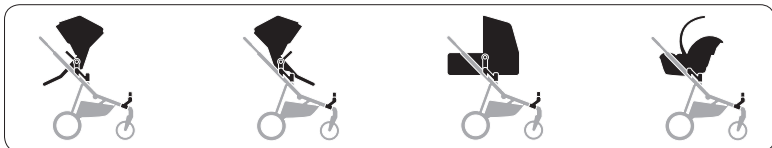

Content

Introduction

Visual language in instructions
Introduction to Thule Sleek Sibling Seat
Safety guidelines
Maintenance

Preparing for use

In the box
Assembling the sibling seat
Mounting the sibling seat

Instruction for use

Using the sibling seat
Folding stroller
Using the rain cover

Visual language in instructions

The meaning of the visual language used in these instructions:



Visual check OK.



Conveys additional information.



Visual check not OK.



Indicates that special attention is required.



Audible click.



Indicates that special attention is required and refers to a paragraph in the safety guidelines section of these instructions.



Movement in given direction.



Indicates that special attention is required and refers to a paragraph in the safety guidelines section of the separate safety booklet delivered with this product.

2x

Repeat action.

➤ Features

1. Sibling seat
2. Canopy
3. Sun visor
4. Zipper for canopy extension and ventilation
5. Peekaboo window
6. Swing away bumper bar
7. Harness
8. Seat recline handle
9. Foot rest adjust button
10. Seat release button

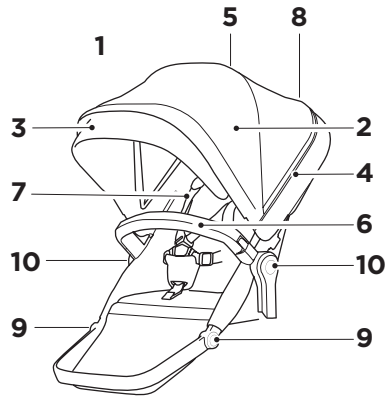

WARNING:

- i1. **IMPORTANT** - Keep these instructions for future reference. Your child's safety may be affected if you do not follow these instructions.
- i2. Read the Safety manual for Thule Strollers before use and keep for future reference.

IMPORTANT INFORMATION

Thule Sleek Sibling Seat is only compatible with Thule Sleek stroller.

MAINTENANCE

Keeping your Thule Sleek stroller clean and well maintained is an important factor in keeping it in good condition.

Regularly inspect your stroller and accessories for damage and signs of wear:

- Check metal components for any dents or cracks. Do not use the stroller if any metal components are cracked or damaged.
- Examine the fabric regularly for tears, worn spots or any other signs of damage.

The fabrics on Thule Sleek Sibling Seat can be cleaned by hand.

- Spot clean or hand wash gently with mild soap & warm water. Do not use cleaning solvents.
- Rinse well with warm water.
- Hang to air dry completely.
- Do not machine wash! No bleach. Do not iron. Do not dry clean.
- If needed seat and canopy fabric can be removed for cleaning.

Store your stroller and accessories in a dry area out of direct sunlight. Before storing your stroller, it should be dry to prevent the growth of mold or bacteria.

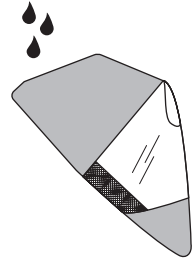
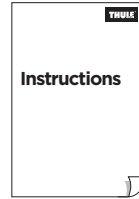
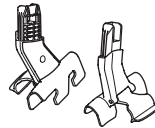
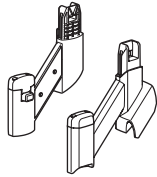
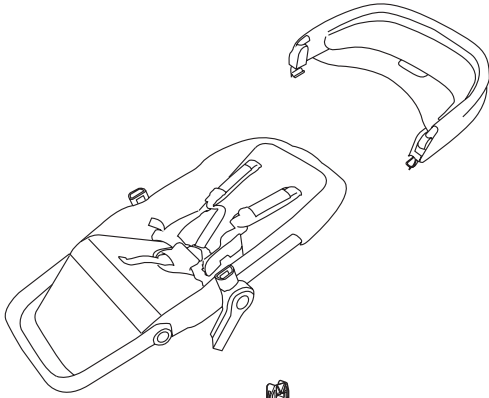



1

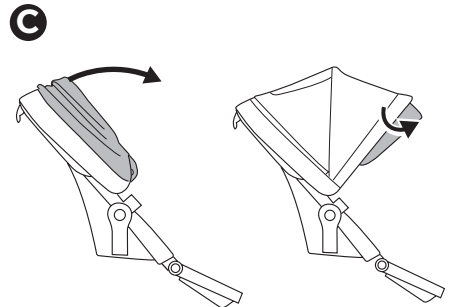
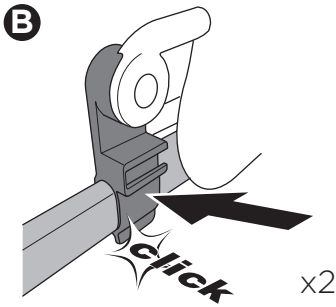
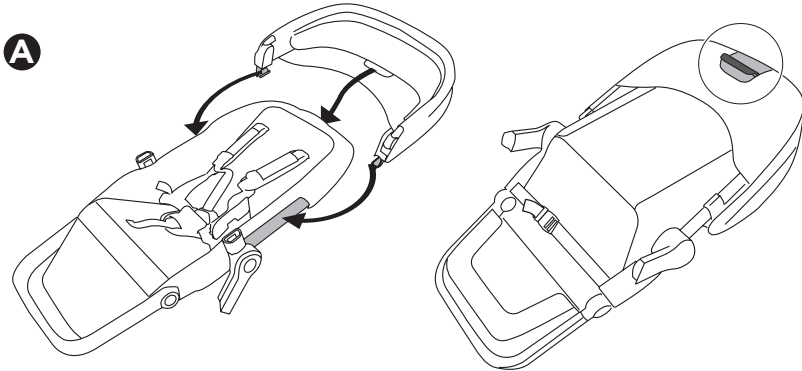

2

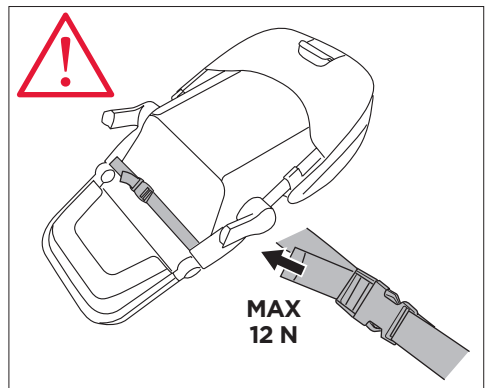
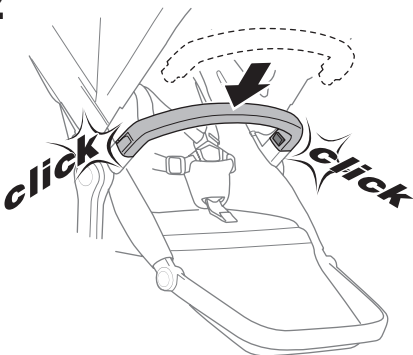

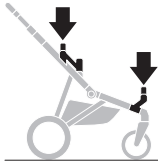

1

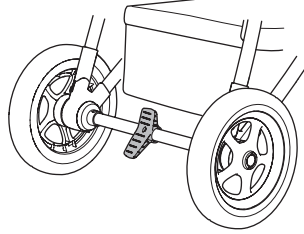
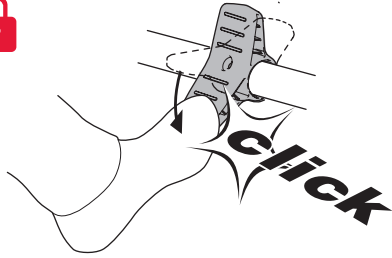

2

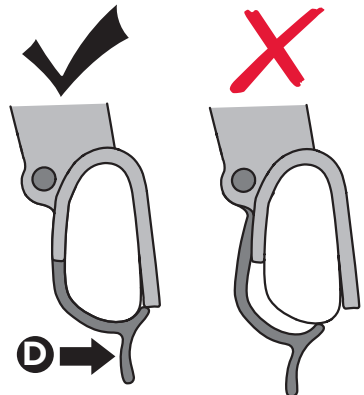
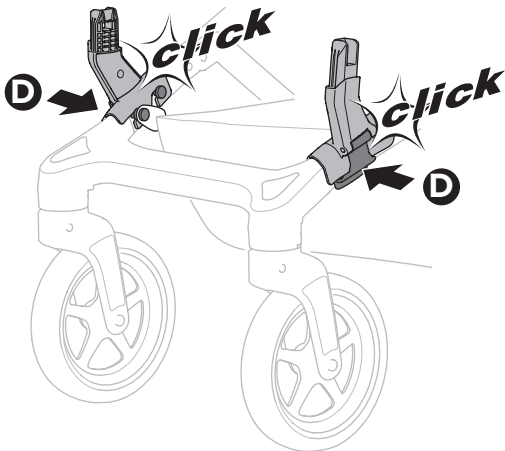
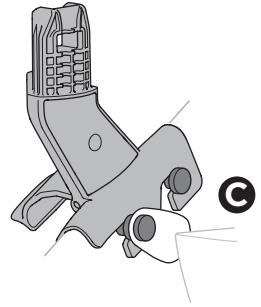
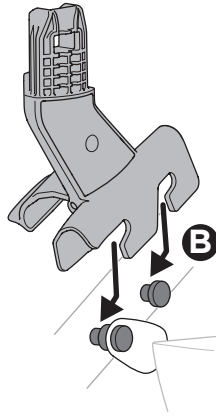
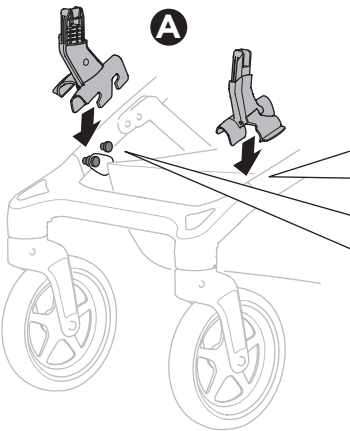

3

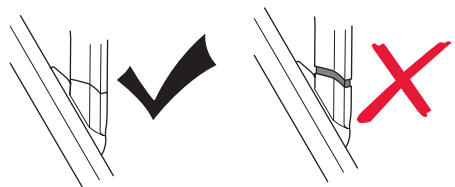
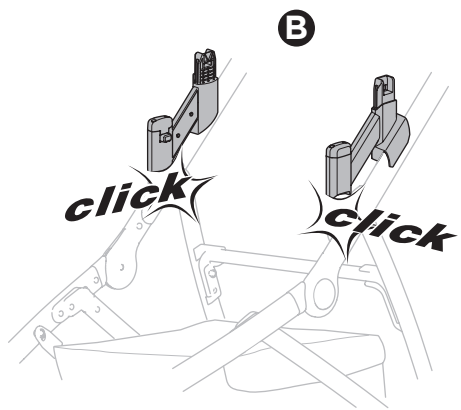
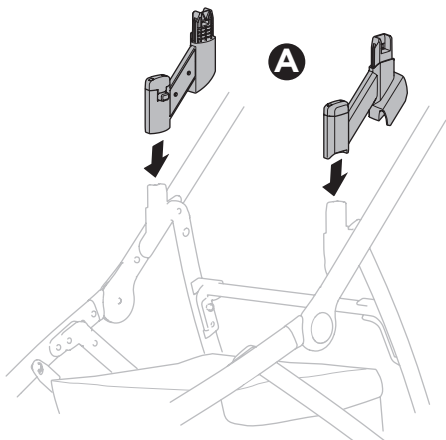

i

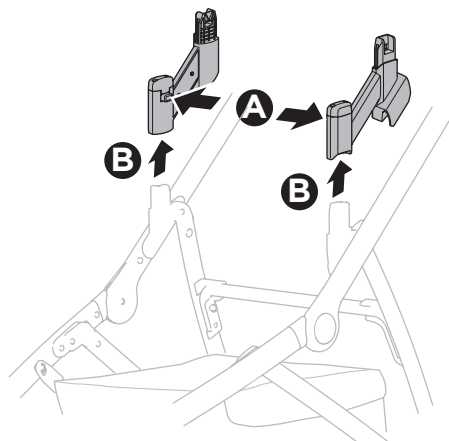
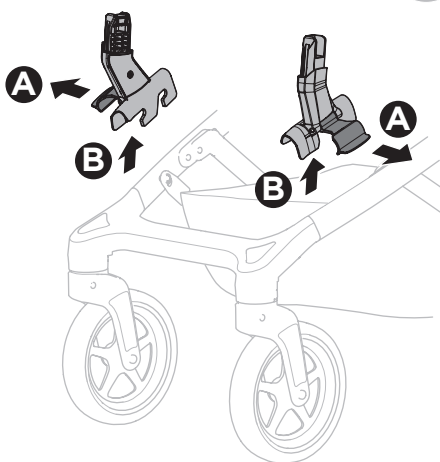
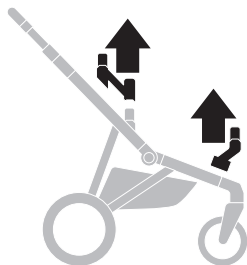

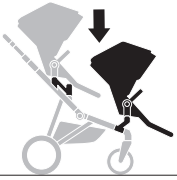

1

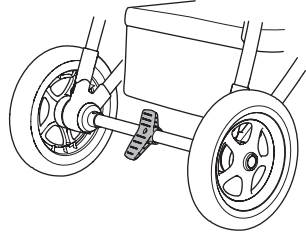
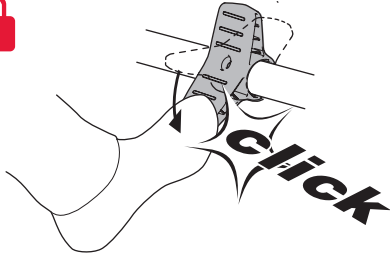

2

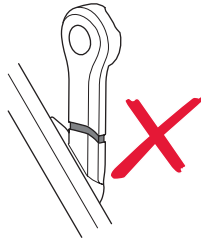
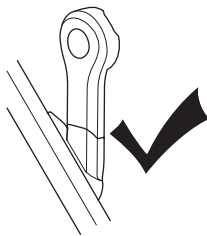
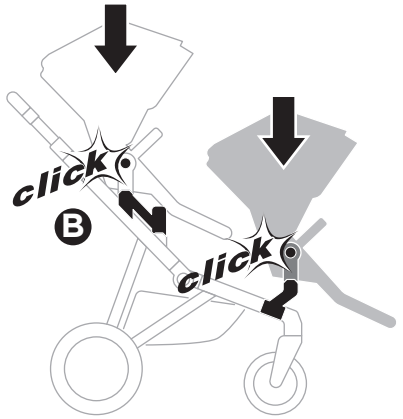

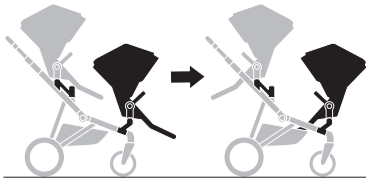

1

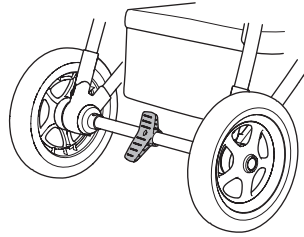
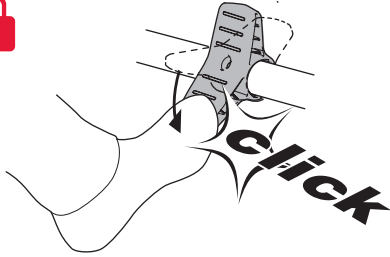

2

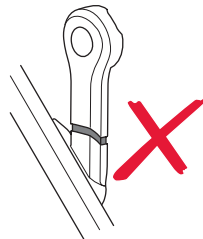
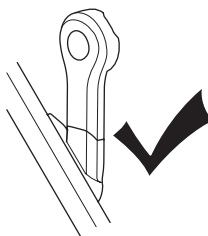
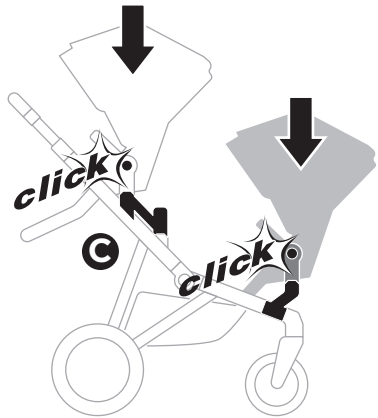
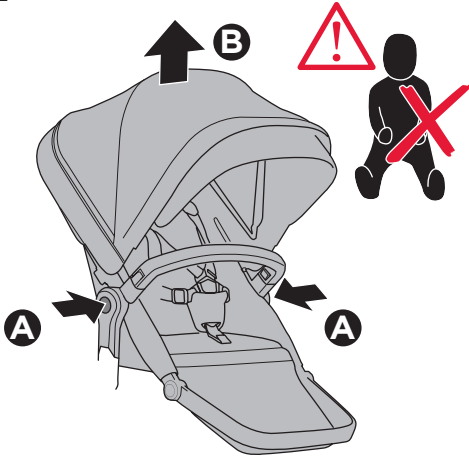



1

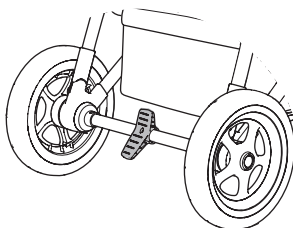
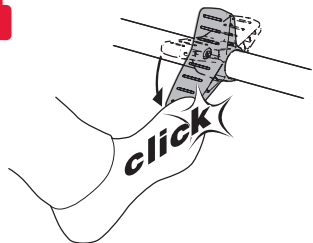

2

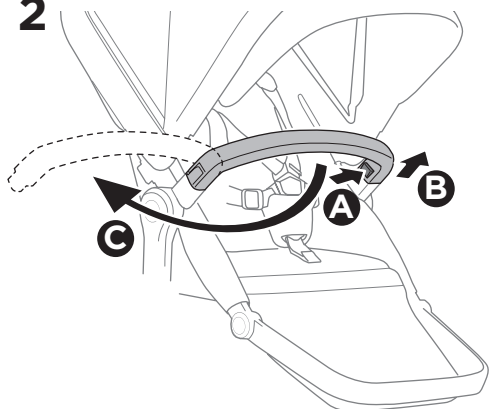

3

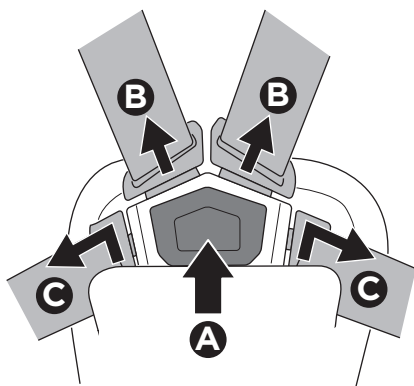
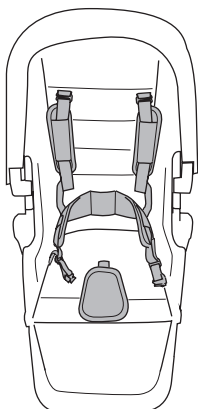

4

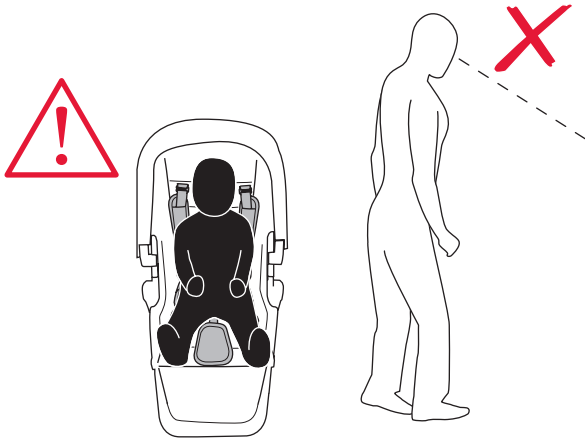

5

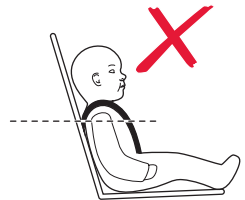
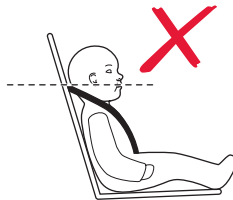
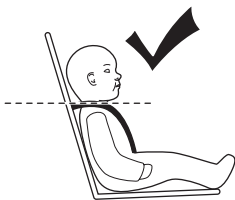
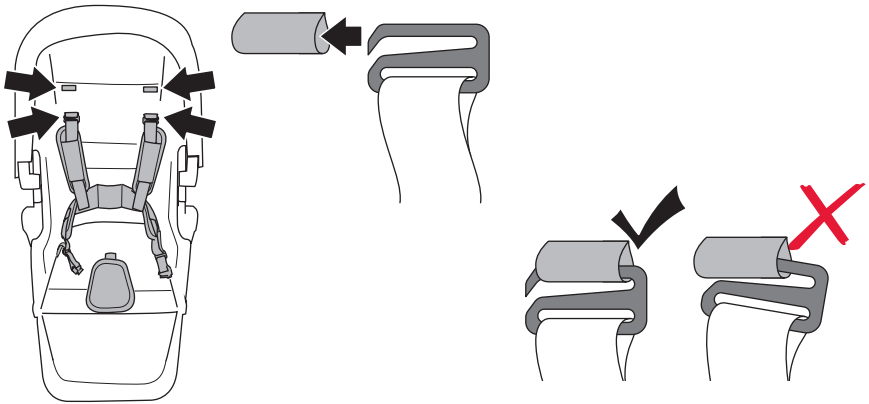

6

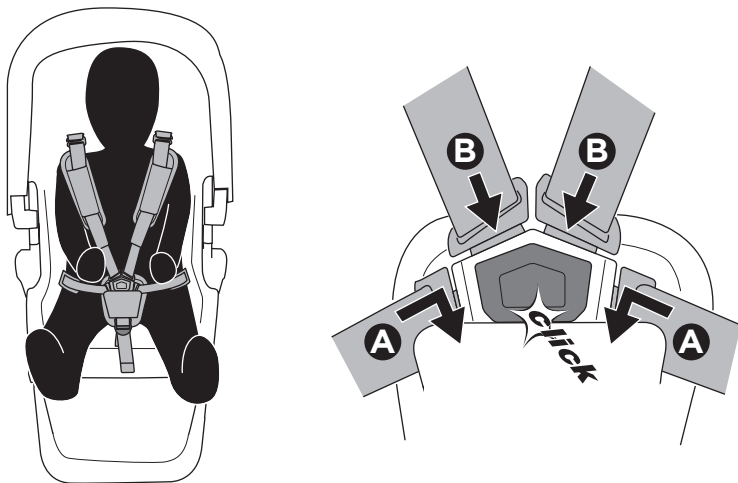

7

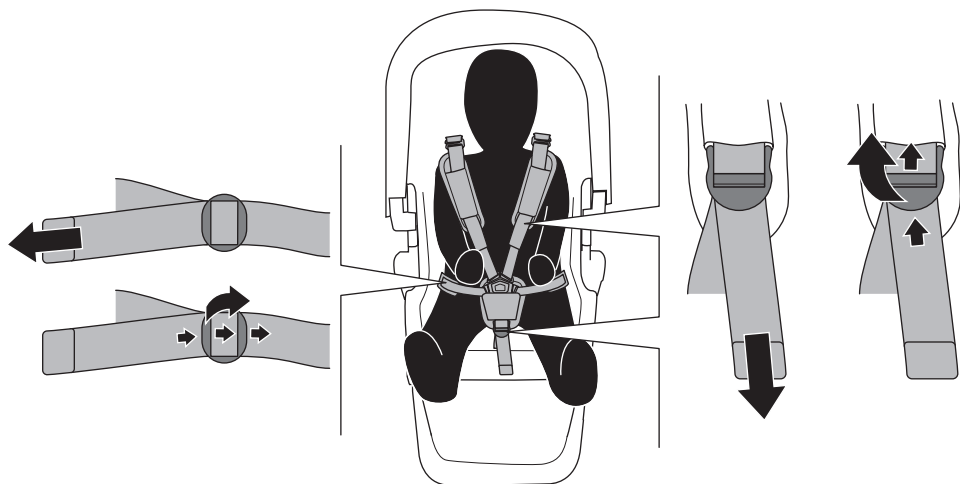



1

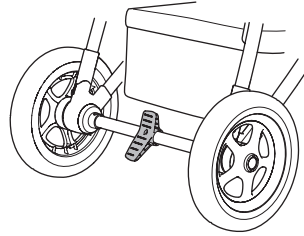
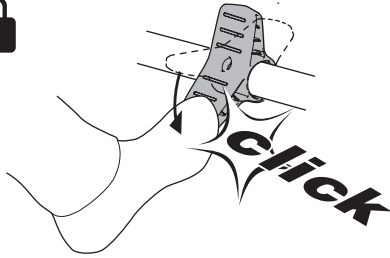

2

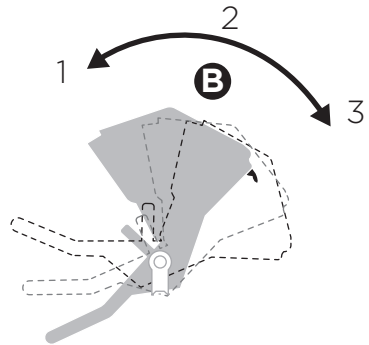
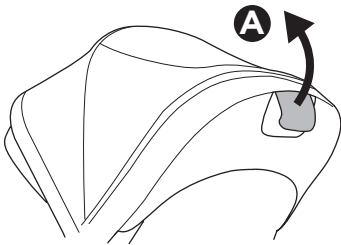

3

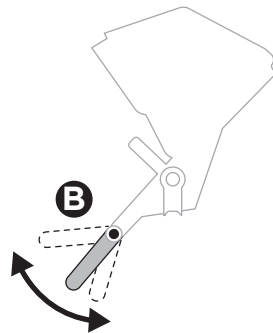
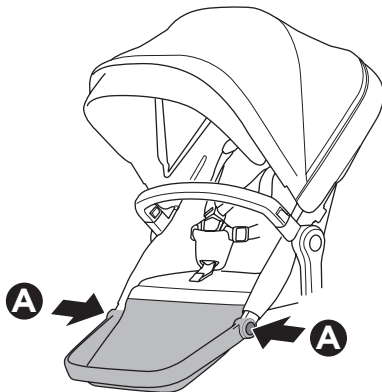



1

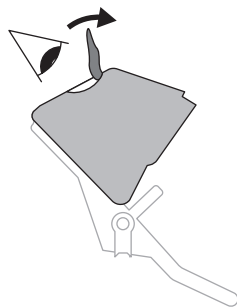
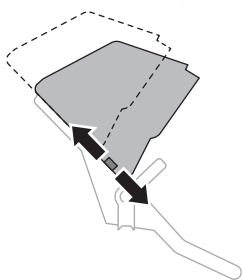
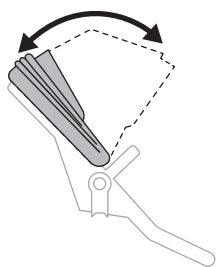
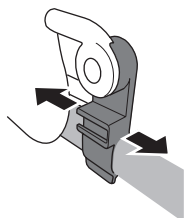

2

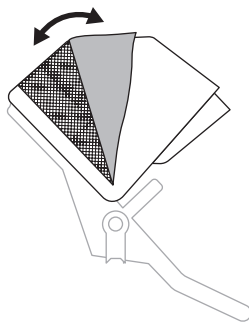
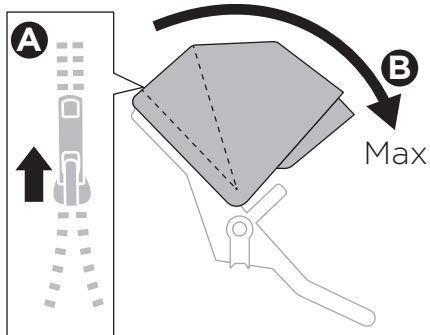



1

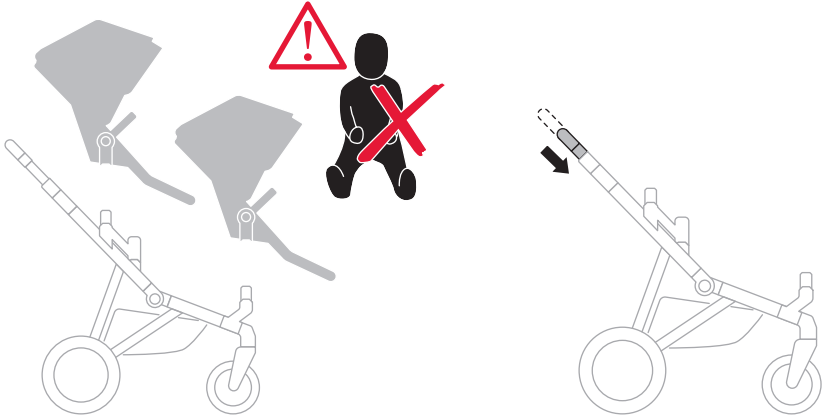

2

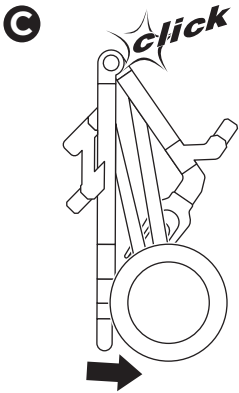
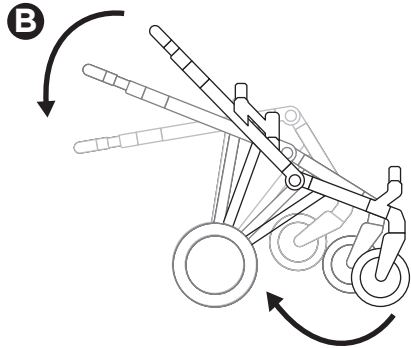
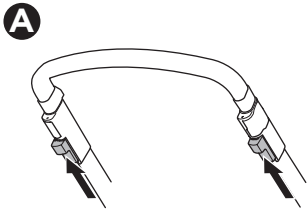



1

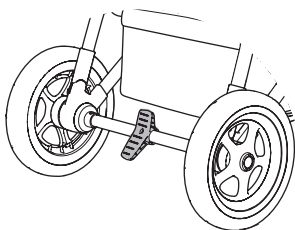

2

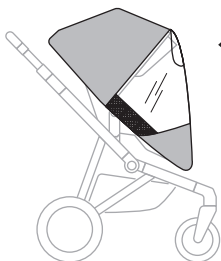
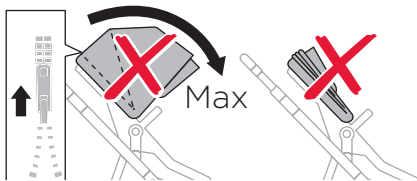
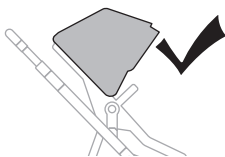

A

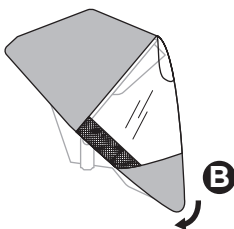
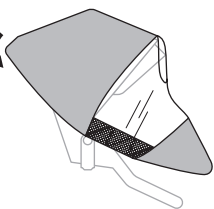

i

