

➤ Instructions Thule Sleek











11000001, 11000002, 11000003, 11000004, 11000005, 11000006,
11000007, 11000008, 11000009, 11000010, 11000011, 11000012,
11000013, 11000014, 11000015, 11000016













Stroller

For children of age 6 months and older (up to 15 kg/33 lb) that can sit unaided. From birth when used with Thule Sleek Bassinet.



			
<p>MAX kg </p>	<p>15 kg </p>	<p>15 kg + 15 kg </p>	<p>15 kg + 9 kg </p>
<p>MAX kg </p>	<p>5 kg</p>		
<p>MAX </p>	<p>111 cm</p>		

			
<p>MAX lbs </p>	<p>49 lbs </p>	<p>33 lbs + 33 lbs </p>	<p>33 lbs + 20 lbs </p>
<p>MAX lbs </p>	<p>11 lbs</p>		
<p>MAX </p>	<p>44"</p>		





Approved configurations

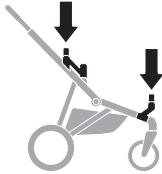
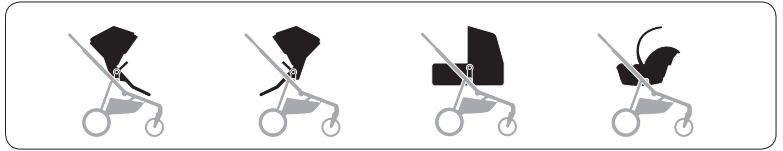

Not Approved configurations

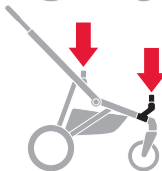
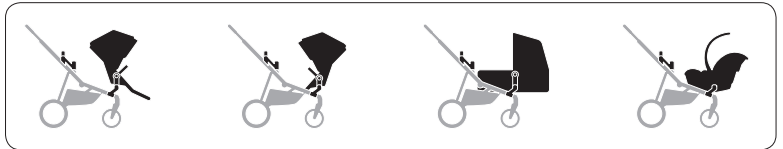
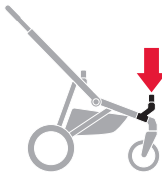
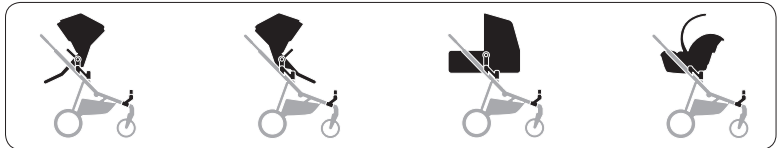

Congratulations

And thank you for choosing Thule Sleek! You can rest assured that we have put all our efforts, knowledge and passion into designing the most stylish, flexible and safe stroller we could think of. All so that you and your child are free to go wherever your curiosity takes you.

Before you use your Thule Sleek, please read the following instructions carefully and keep them for future reference.

Let's go!

/Thule

Content

Introduction

- Visual language in instructions
- Introduction to Thule Sleek
- Safety guidelines
- Maintenance
- Warranty information
- Accessories
- Contact

Instruction for use

- Using the parking break
- Adjusting the handlebar
- Using the wrist strap
- Using the seat
- Folding and unfolding
- Locking front wheels
- Using the basket
- Using the rain cover

Preparing for use

- In the box
- Assembling the chassis
- Assembling the seat
- Mounting the seat

Visual language in instructions

The meaning of the visual language used in these instructions:



Visual check OK.



Conveys additional information.



Visual check not OK.



Indicates that special attention is required.



Audible click.



Indicates that special attention is required and refers to a paragraph in the safety guidelines section of these instructions.



Movement in given direction.



Indicates that special attention is required and refers to a paragraph in the safety guidelines section of the separate safety booklet delivered with this product.

2x

Repeat action.

➤ Features

1. Handlebar
2. Wrist strap
3. Handlebar height adjustment
4. Fold slide-buttons
5. Main seat
6. Canopy
7. Sun visor
8. Zipper for canopy extension and ventilation
9. Peekaboo window

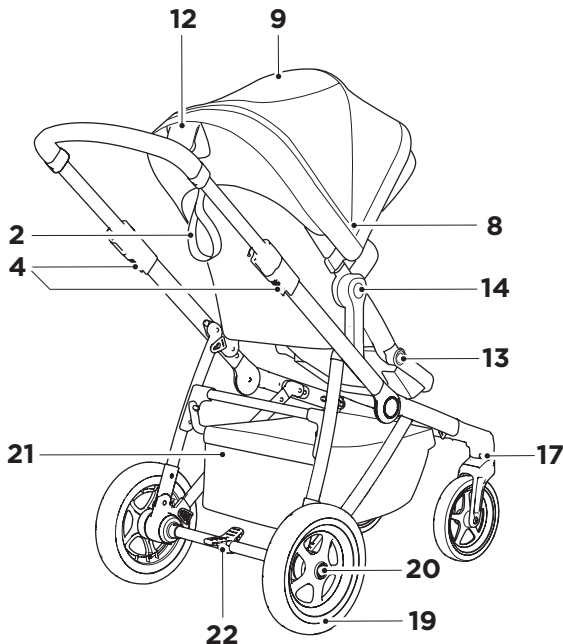
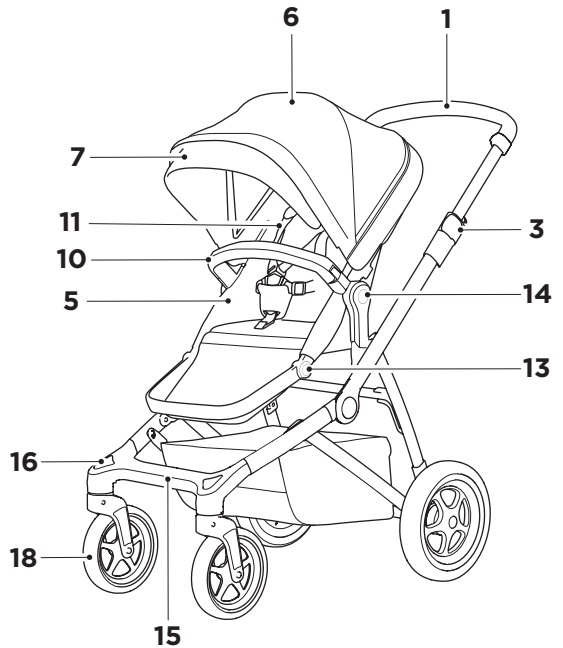

10. Swing away bumper bar
11. Harness
12. Seat recline handle
13. Foot rest adjust button
14. Seat release button
15. Foot step
16. Wheel locking button
17. Wheel release button
18. Swivel front wheel
19. Rear wheel
20. Rear wheel release button
21. Basket
22. Parking break

WARNING:

- i1.** IMPORTANT - Keep these instructions for future reference. Your child's safety may be affected if you do not follow these instructions.
- i2.** Read the Safety manual for Thule Strollers before use and keep for future reference.

IMPORTANT INFORMATION

Thule Sleek chassis is only compatible with Thule Sleek main seat, Thule Sleek Sibling Seat, Thule Sleek Bassinet and Thule Sleek Car Seat Adapters.

MAINTENANCE

Keeping your Thule Sleek stroller clean and well maintained is an important factor in keeping it in good condition.

Regularly inspect your stroller and accessories for damage and signs of wear:

- Check metal components for any dents or cracks. Do not use the stroller if any metal components are cracked or damaged.
- Examine the fabric regularly for tears, worn spots or any other signs of damage.

The fabrics on Thule Sleek can be cleaned by hand.

- Spot clean or hand wash gently with mild soap & warm water. Do not use cleaning solvents.
- Rinse well with warm water.
- Hang to air dry completely.
- Do not machine wash! No bleach. Do not iron. Do not dry clean.
- If needed seat and canopy fabric can be removed for cleaning.

The Thule Sleek chassis and wheels can be cleaned with a damp cloth. Dry it with a dry cloth.

If wheels squeak, lubricate sparingly with silicone lubricant. Do NOT use oil or grease based products, as this will attract dirt,

which will clog the movement.

Store your stroller and accessories in a dry area out of direct sunlight. Before storing your stroller, it should be dry to prevent the growth of mold or bacteria.

WARRANTY AND REPLACEMENT PARTS

Thule is dedicated to providing exceptional products that are quality tested and guaranteed against defects in materials and workmanship.

Only use replacement parts supplied or recommended by Thule.

Replacement parts are available for purchase at your local Thule dealer.

ACCESSORIES

You can easily increase the functionality of your Thule Sleek stroller by adding one or more accessories, from car seat adapter to cup holder to color-matching footmuff. With added convenience and comfort for both parent and child, your strolls will become even more enjoyable.

CONTACT

We are always interested to get your feedback and answer your questions on our products to make sure we give the best experience possible.

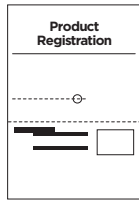
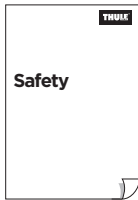
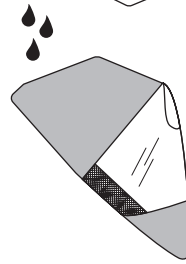
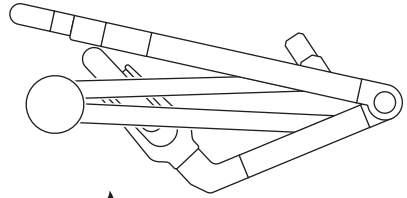
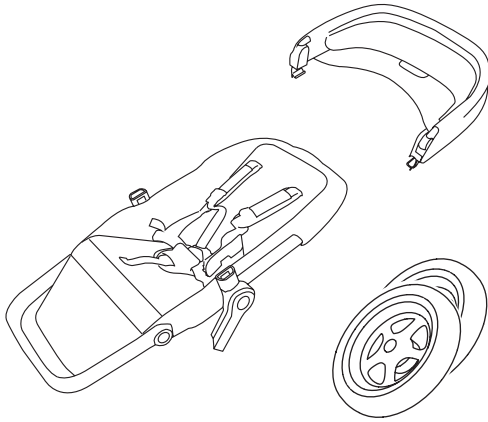
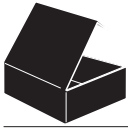



1

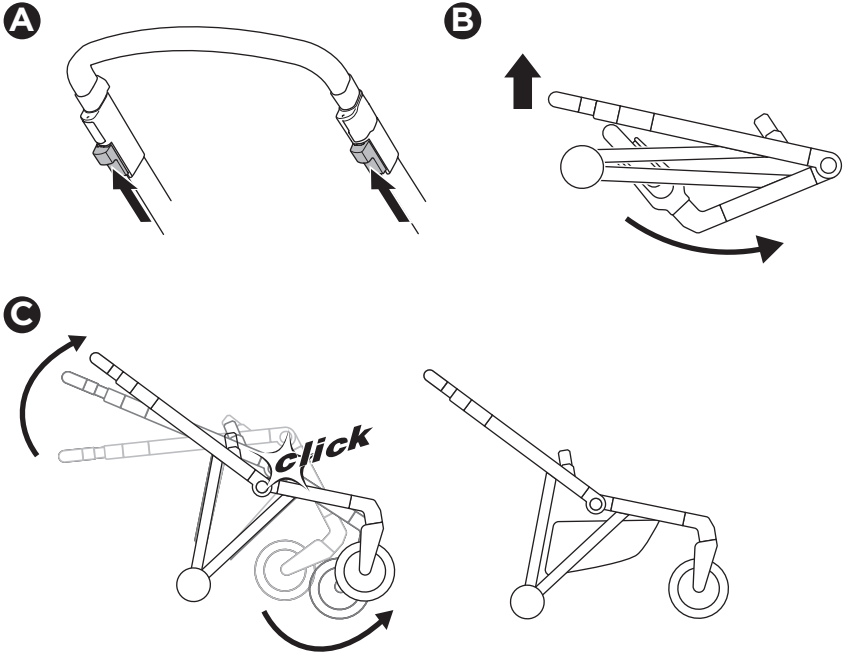

2

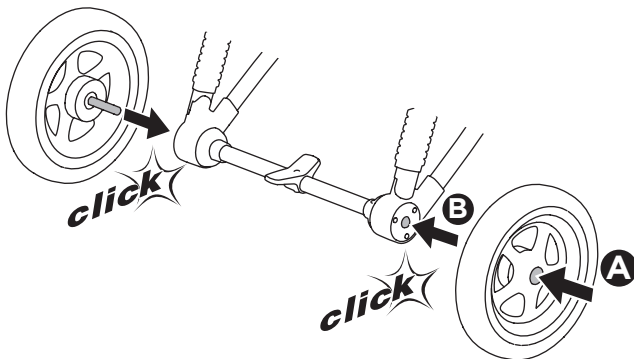



1

A

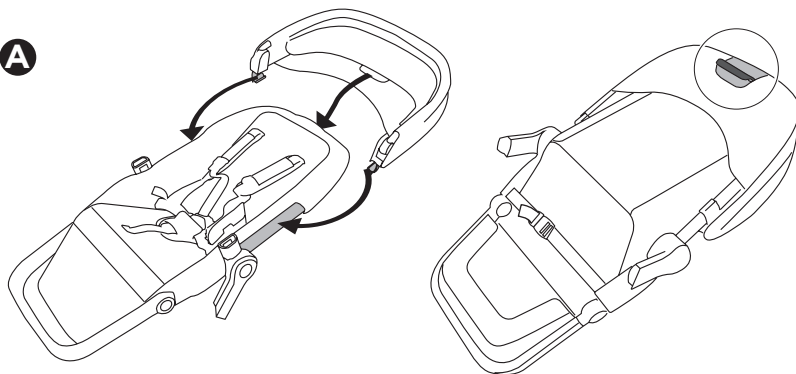

B

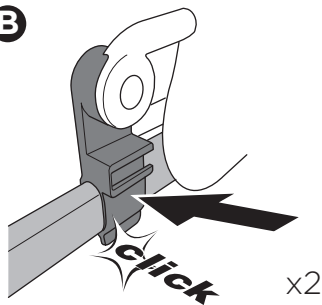

C

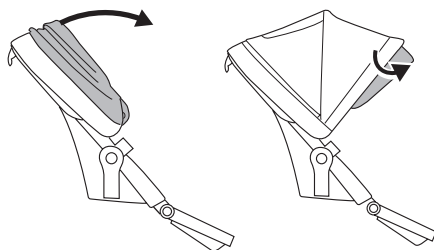

2

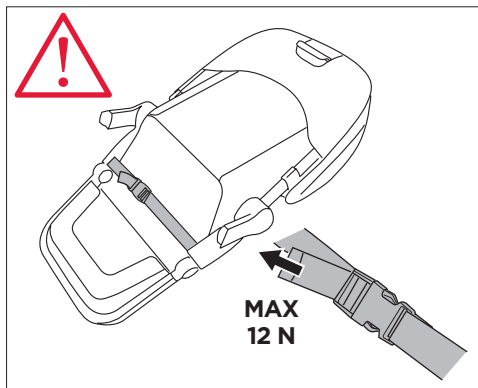
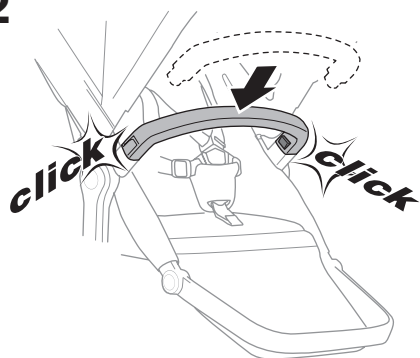

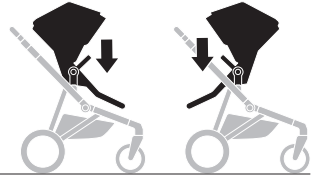

1

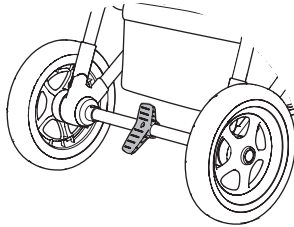
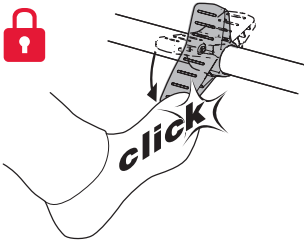

2

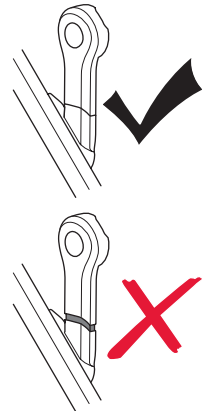
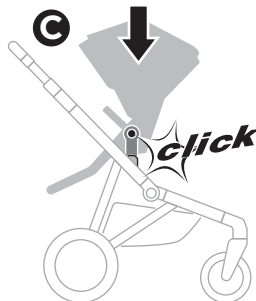
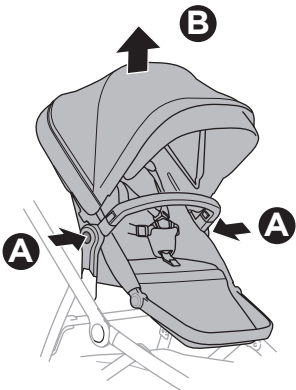
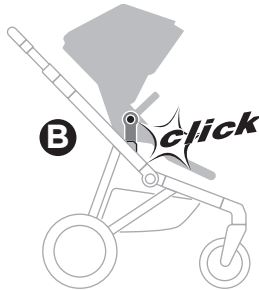
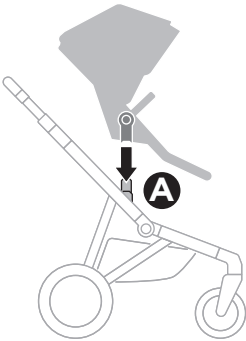

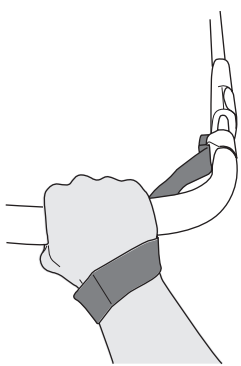
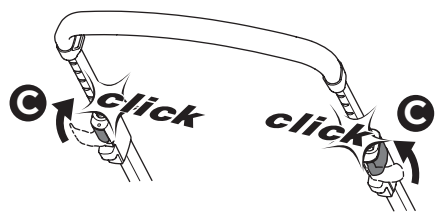
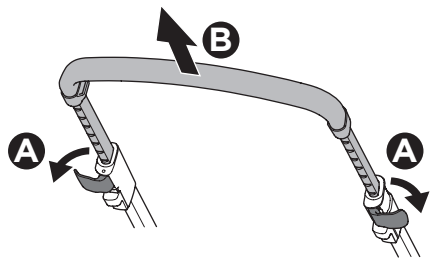
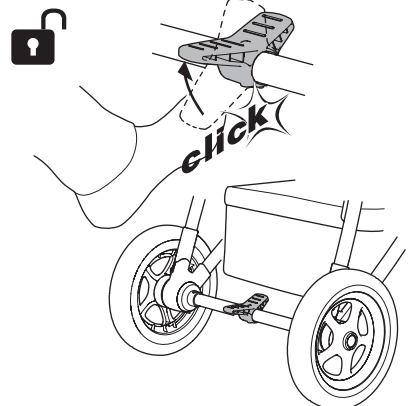
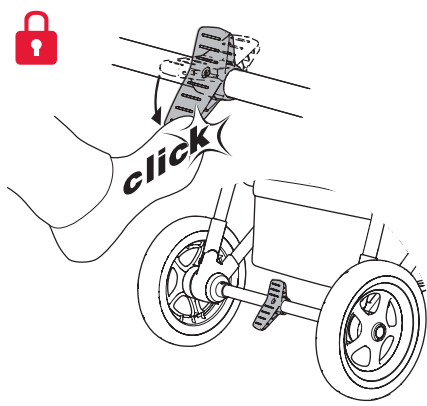
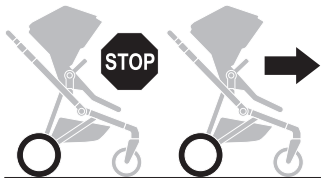

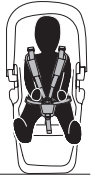

1

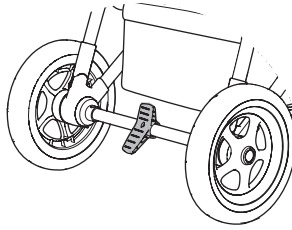
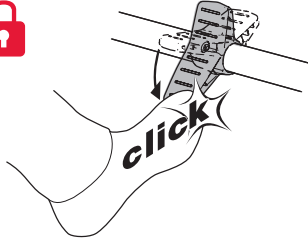

2

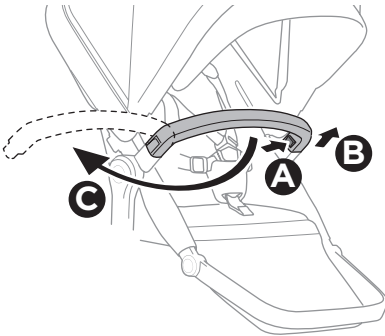

3

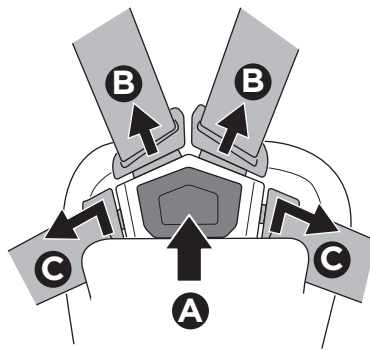
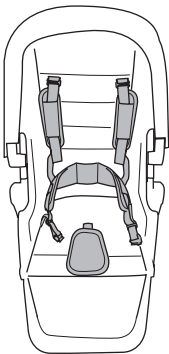

4

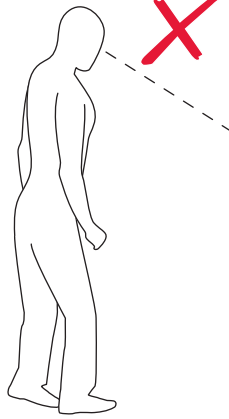

5

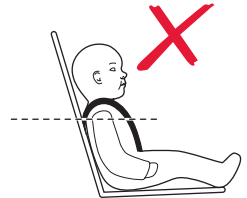
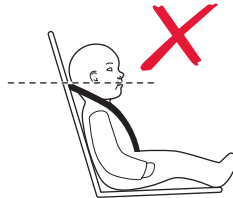
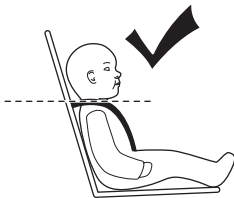
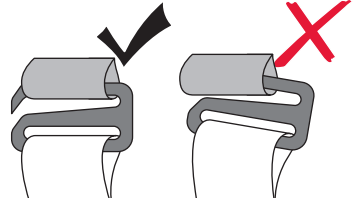
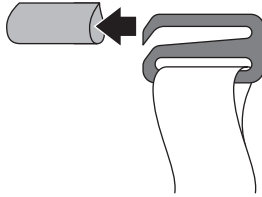
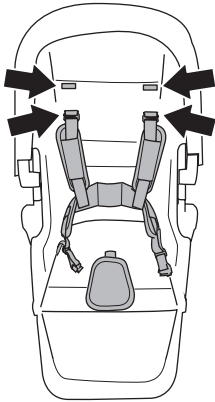

6

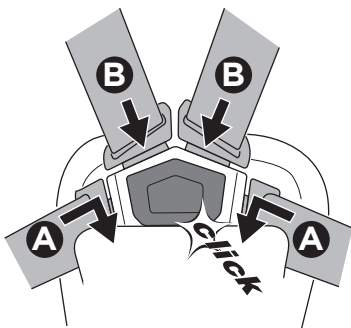
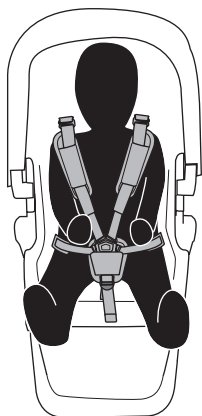

7

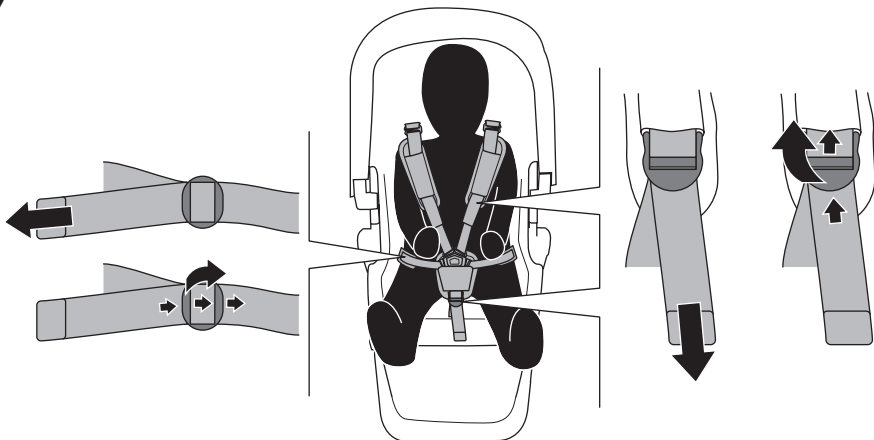



1

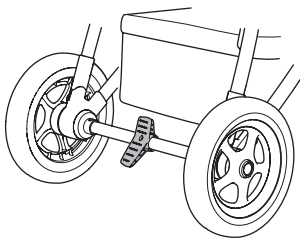
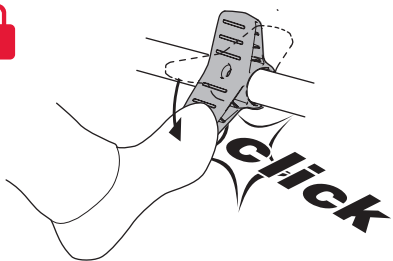

2

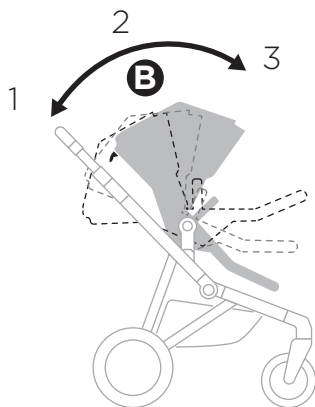
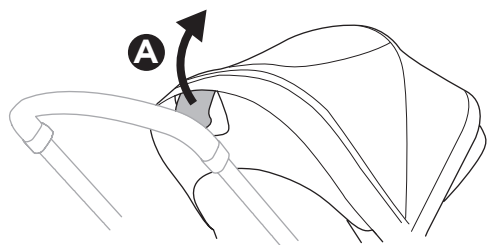

3

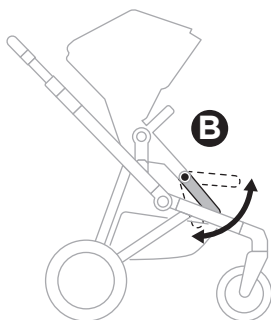
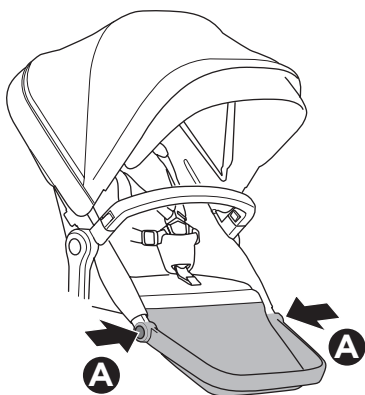



1

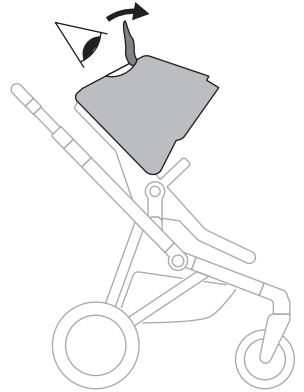
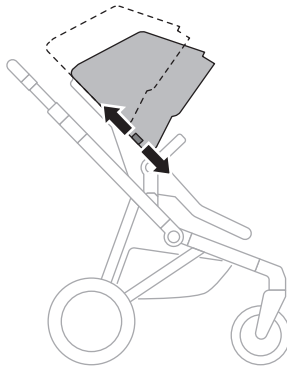
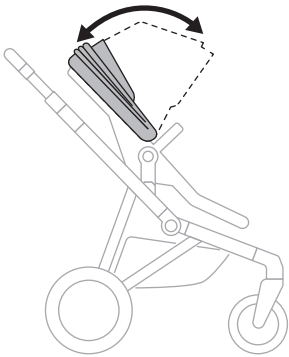
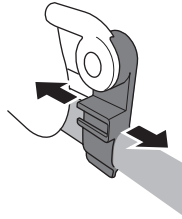

2

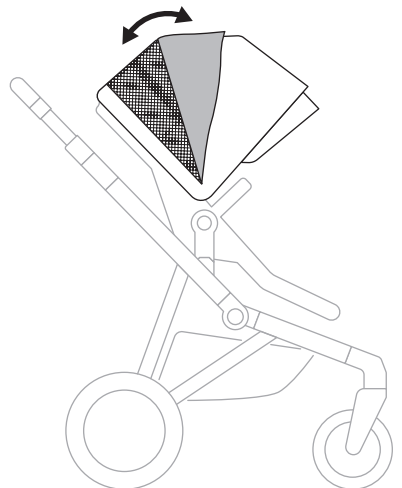
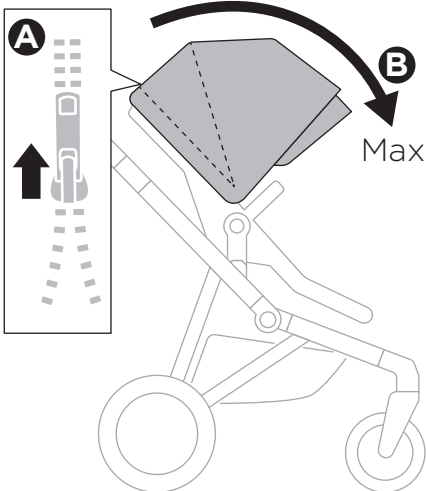



1

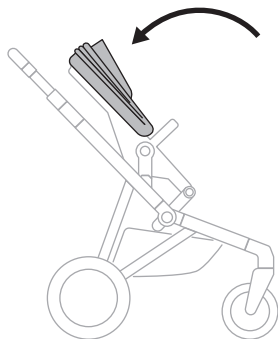
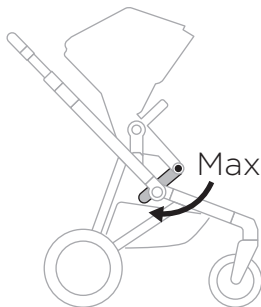
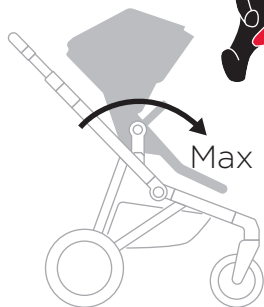

2

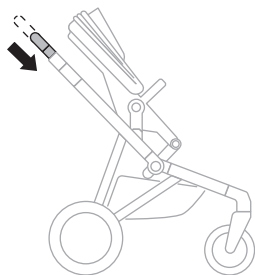

A

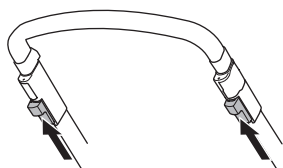

B

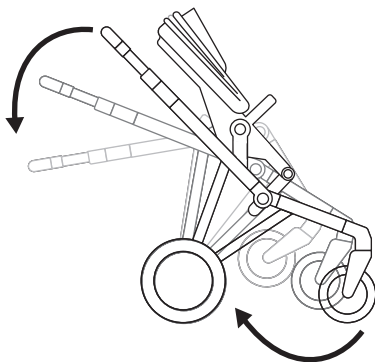

C

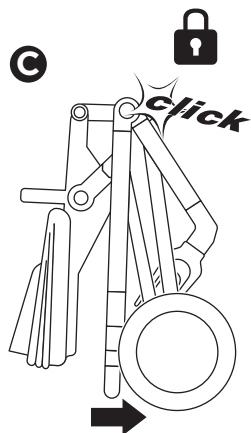

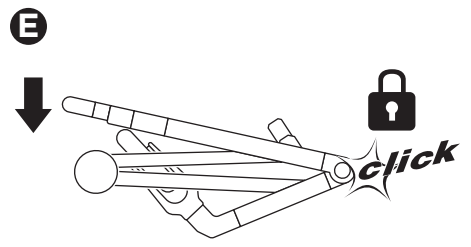
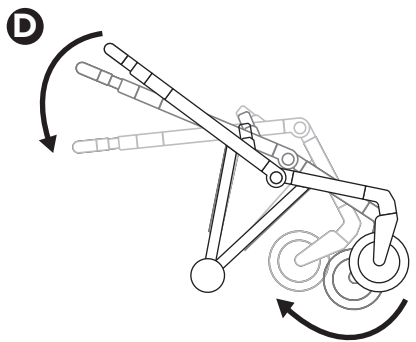
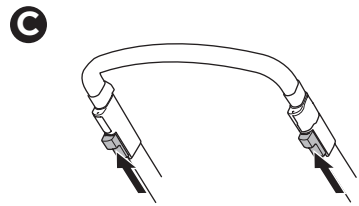
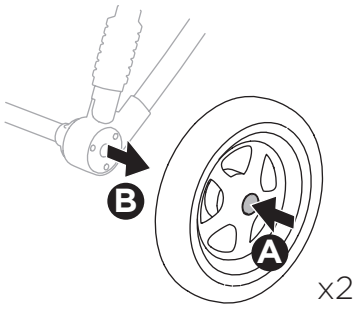
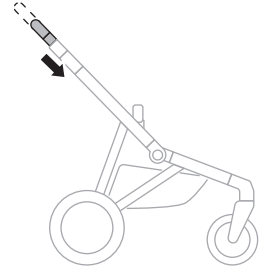

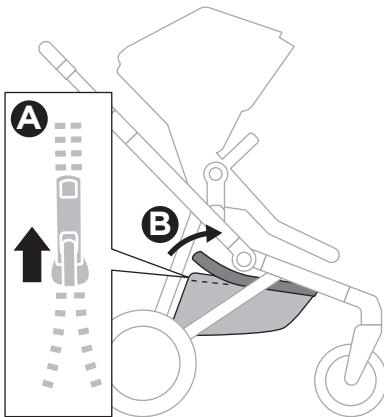
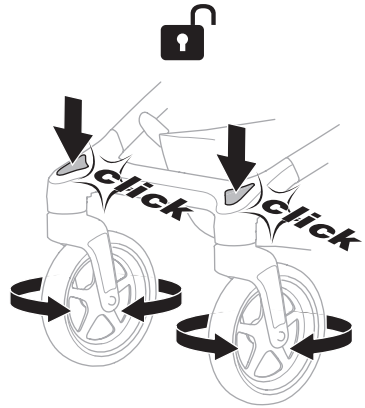
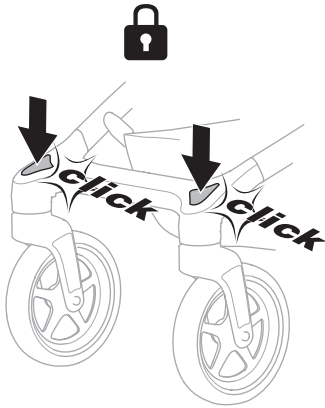
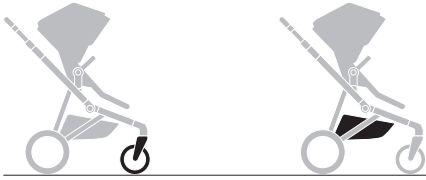

Max 5 kg
11 lbs

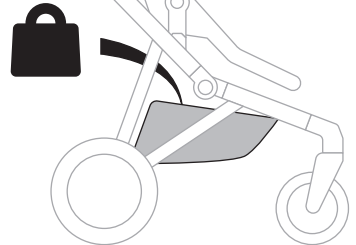



1

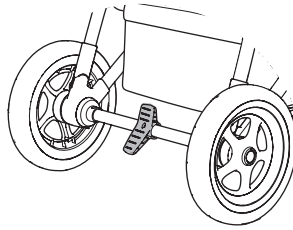
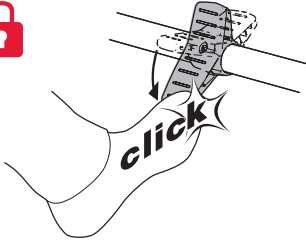

2

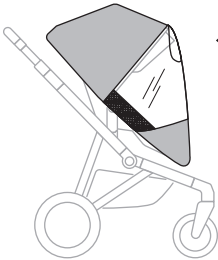
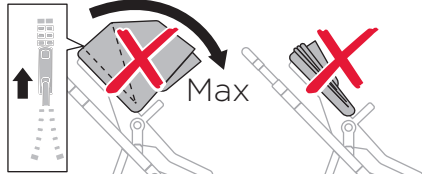
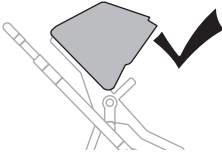

A

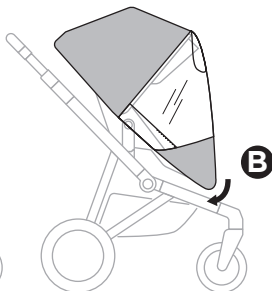
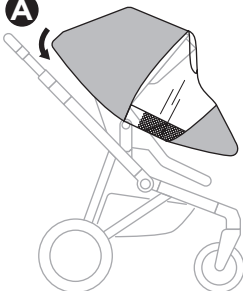

i

