



TENPOINT
CROSSBOW TECHNOLOGIES



2020 PRODUCT CATALOG

PERFECTION LIVES HERE™

OTHERS **DE-COCK.** WE DO IT **SAFELY.** THE TENPOINT ADVANTAGE.



NEW XTEND CRANK HANDLE

- Adjusts from 5" to 7.5"
- Reduces effort required to cock the crossbow to only 5-pounds
- Conveniently stores in the stock

NEW TRIGGER LOCK-LATCH

- Locks trigger box in same position every time the bow is cocked
- Improves down-range accuracy by 48%



NEW ACUSLIDE

- Silent Cocking
- Safe De-Cocking

NEW S1 TRIGGER

- Advanced Roller Sear Design
- 2-Stage Design
- Zero-Creep
- Crisp, 3.5-pound pull
- Provides a level of accuracy never experienced before with a crossbow



NEW

ACUslide™

COCKING & DE-COCKING SYSTEM

THE INDUSTRY'S FIRST SILENT COCKING, SAFE DE-COCKING SYSTEM

Forget holding buttons, using straps, and losing control while de-cocking. Meet TenPoint's new ACUslide – The only safe and controlled crossbow de-cocking system on the market. Simply backwind the handle – stopping at any point without fear of damage, injury, or losing control.

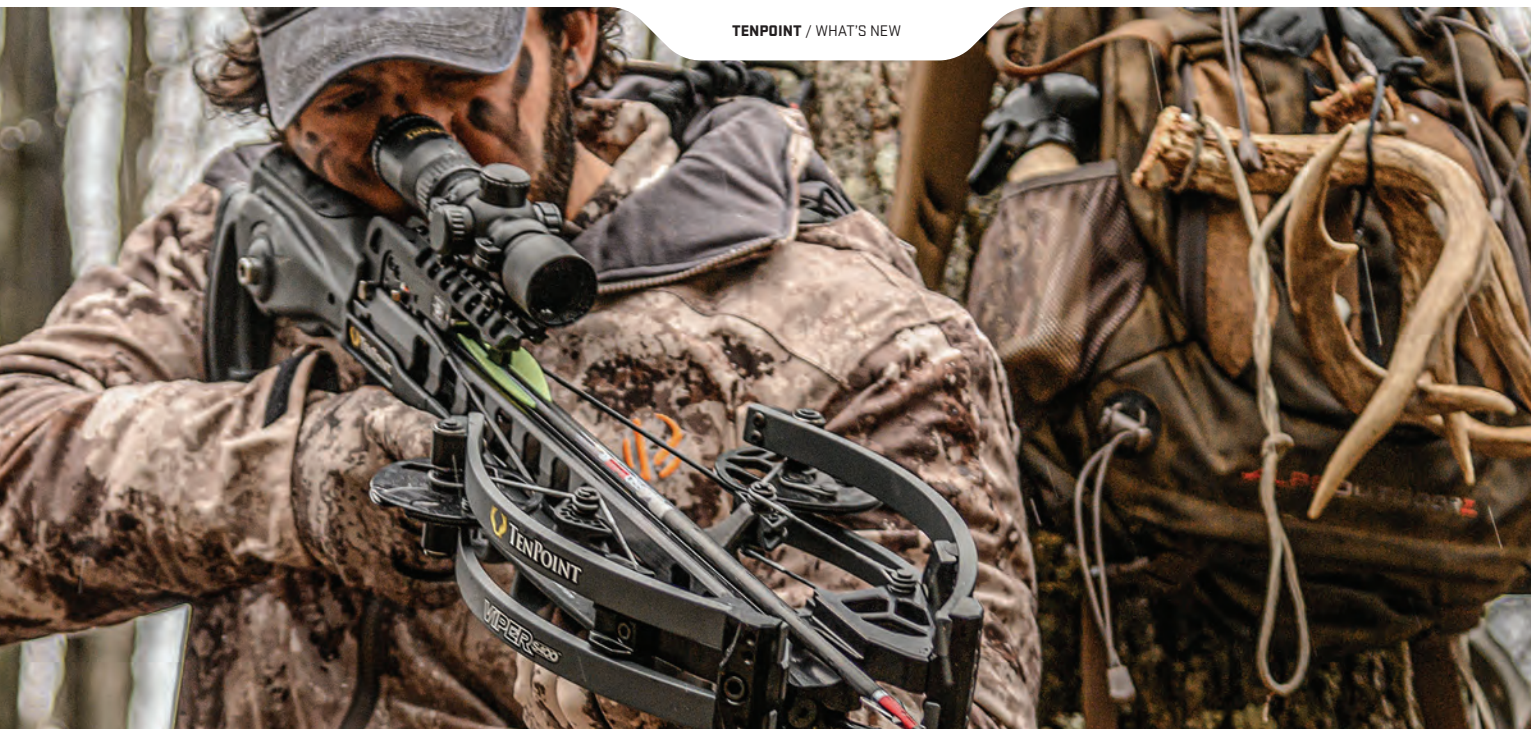

NEW ROLLER SYSTEM

2 stainless steel rollers allow the trigger box to "glide" inside the barrel – creating an ultra-smooth feel during the silent cocking and controlled de-cocking process.



NEW MICRO-TRAC BARREL

- Reduces string-to-rail contact by an incredible 50%
- Increases down-range accuracy
- Provides the longest string life in the industry

VECTOR QUAD™ CABLE SYSTEM

- Utilizes 4 cables, instead of the traditional 2
- Eliminates cam lean and generates straight nock travel, leading to same hole down-range accuracy
- Unlike other crossbows on the market, allows for micro-tuning to ensure the highest level of accuracy

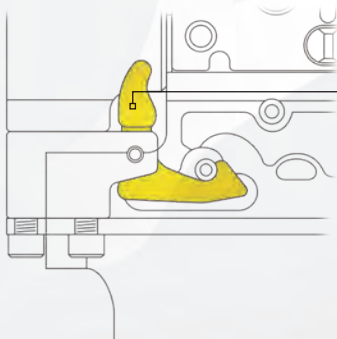

IT TAKES A LATCH TO LOCK DOWN ACCURACY
TRIGGER LOCK-LATCH

Stainless steel latch locks the trigger box at full-draw – relieving the tension from the ACUslide unit and guaranteeing that your trigger box is in the same location on each shot, leading to 48% increased down-range accuracy.

"These are the most accurate crossbows I have ever shot. You won't be disappointed."

RICK BEDNAR - CEO

THIS CHANGES EVERYTHING.



NEW FOR 2020

VAPOR RS470™

AVAILABLE FINISH



VEIL ALPINE™



GRAPHITE



6.5-INCHES WIDE

NEW MICRO-TRAC BARREL

Reduces string-to-rail contact by an incredible 50% - leading to increased accuracy and the longest string life in the industry.

SPEED
UP TO:
470
FPS

WIDTH
6.5
INCHES

LENGTH
31.0
INCHES



AVAILABLE AS COMPLETE PACKAGE
SEE PAGES 10 & 11

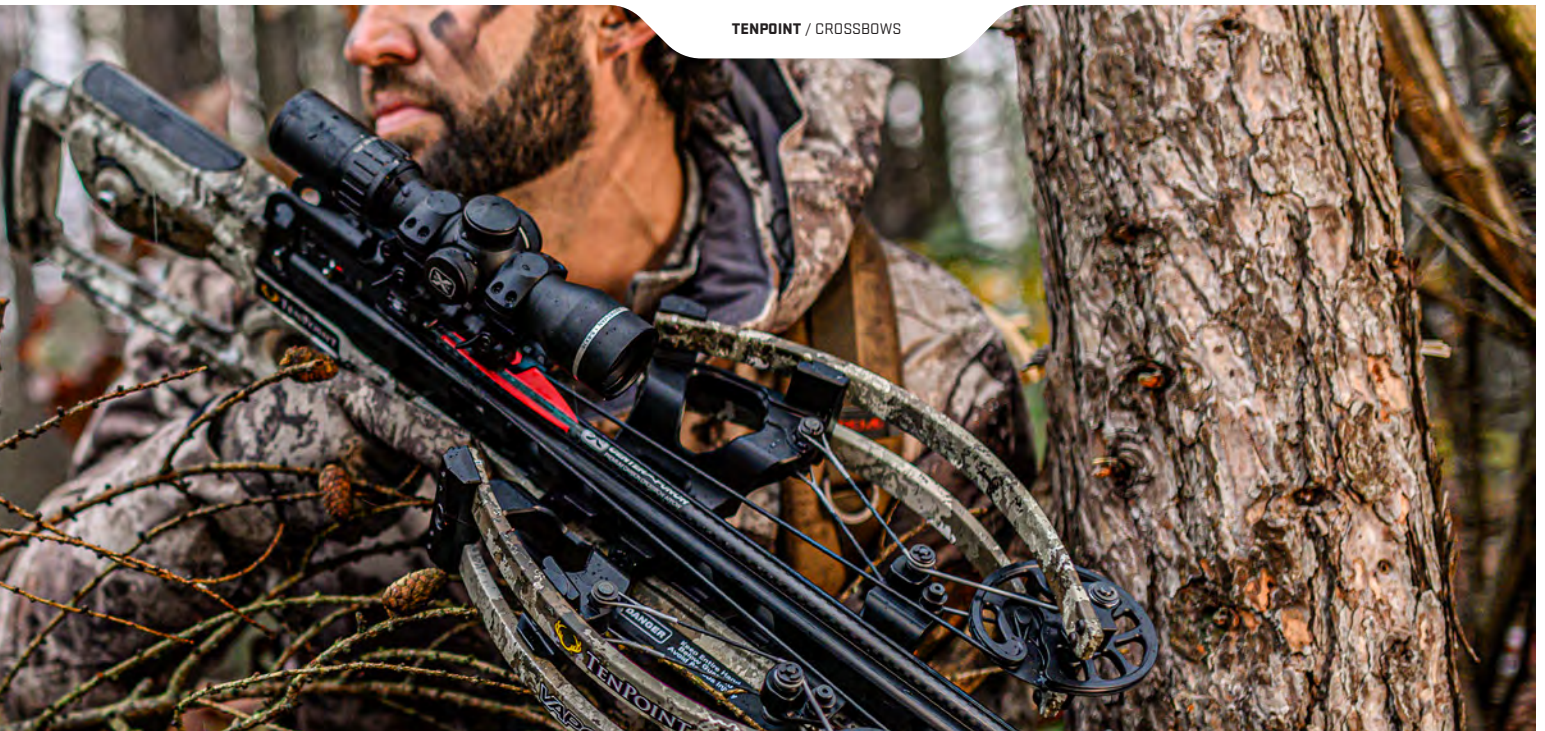

EVO-X® MARKSMAN™ SCOPE

The premier crossbow scope on the market features a variable speed design and fully multi-coated optics that provide unmatched brightness in low light situations.

REVERSE-DRAW ADVANTAGE

The most powerful engine available for a crossbow - features a center-mounted riser providing unmatched balance and unprecedented speed and accuracy.

NEW TEC-X STOCK

Dramatically minimizes stock size, reducing the weight of the crossbow by 1/2-pound.



NEW ACUSLIDE COCKING & DE-COCKING SYSTEM

Provides silent cocking and safe de-cocking.

NEW S1 TRIGGER

2-stage, zero-creep design features a roller seat system that sets a new standard in high-performance crossbow accuracy.

THE COMPLETE HUNTING SYSTEM
EVERYTHING YOU NEED TO FOR AN UNMATCHED HUNTING EXPERIENCE

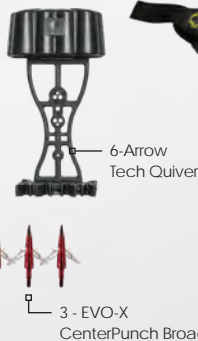
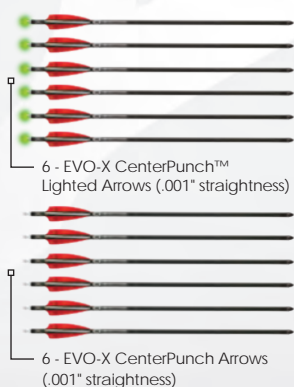

NEW FOR 2020

VENGENT

S440™

THE FASTEST AND NARROWEST FORWARD DRAW CROSSBOW EVER.

SPEED

UP TO:
440
FPS

WIDTH

5.8
INCHES

LENGTH

35.0
INCHES



ULTRA-NARROW



5.8-INCHES WIDE

NEW MICRO-TRAC BARREL

Reduces string-to-rail contact by an incredible 50% - leading to increased accuracy and the longest string life in the industry.

NEW TEC-X STOCK

Dramatically minimizes stock size, reducing the weight of the crossbow by 1/2-pound.

RANGEMASTER® PRO SCOPE

Featuring multi-coated glass for optimal light gathering, the variable speed scope includes lighted aiming points for precision down-range accuracy.



NEW ACUSLIDE COCKING & DE-COCKING SYSTEM

Provides silent cocking and safe de-cocking.

NEW S1 TRIGGER

2-stage, zero-creep design features a roller sear system that sets a new standard in high performance crossbow accuracy.



AVAILABLE FINISHES



AVAILABLE AS COMPLETE PACKAGE
SEE PAGES 10 & 11

NEW FOR 2020

VIPER S400™

OUR SHORTEST FORWARD DRAW CROSSBOW EVER.

SPEED

UP TO:
400
FPS

WIDTH

7.2
INCHES

LENGTH

32.0
INCHES



NEW MICRO-TRAC BARREL

Reduces string-to-rail contact by an incredible 50% - leading to increased accuracy and the longest string life in the industry.



7.2-INCHES WIDE

NEW TEC-X STOCK

Dramatically minimizes stock size, reducing the weight of the crossbow by 1/2-pound.

RANGEMASTER® PRO SCOPE

Featuring multi-coated glass for optimal light gathering, the variable speed scope includes lighted aiming points for precision down-range accuracy.



NEW ACUSLIDE COCKING & DE-COCKING SYSTEM

Provides silent cocking and safe de-cocking.

NEW S1 TRIGGER

2-stage, zero-creep design features a roller sear system that sets a new standard in high performance crossbow accuracy.



AVAILABLE AS COMPLETE PACKAGE
SEE PAGES 10 & 11

AVAILABLE FINISHES



NITRO XRT™

Powered by a reverse-draw design, the Nitro XRT is fueled by RX7™ cams and our Vector Quad 4 cable system that generates unprecedented speeds up to 470 FPS withnock-breaking accuracy. Its center-mounted riser eliminates the “nose-heavy” feel of traditional crossbows and produces one of the smoothest shots on the market.



AVAILABLE FINISH

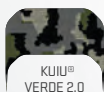

KUIJU®
VERDE 2.0

SPEED UP TO: 470 FPS	WIDTH 6.5 INCHES	LENGTH 29.5 INCHES
---	--------------------------------------	--



8

NEW FOR 2020

XR-410™

The first value-priced, high-performance reverse-draw crossbow in the TenPoint line-up to hit the market, the all-new XR-410 is powered by a reverse-draw design that utilizes the full 17-inches of power stroke to generate blistering speeds up to 410 feet-per-second. Measuring an ultra-narrow 6.5-inches wide, the XR-410 offers unmatched balance and pin-point down-range accuracy.



AVAILABLE FINISH

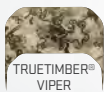

TRUETIMBER®
VIPER

SPEED UP TO: 410 FPS	WIDTH 6.5 INCHES	LENGTH 29.5 INCHES
---	--------------------------------------	--



AVAILABLE AS COMPLETE PACKAGES
SEE PAGES 10 & 11

TURBO[®] M1

Available with the ACUdraw PRO silent cocking device, the Turbo M1 features a radically narrow, 9-inch wide bow assembly powered by VX-5™ inverted cams that elongate the power stroke, producing speeds up to 380 feet-per-second. The lightest, fastest, and narrowest Turbo model to date, the M1 sends arrows down-range with pin-point accuracy.

AVAILABLE FINISH

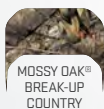

MOSSY OAK[®] BREAK-UP COUNTRY



SPEED	WIDTH	LENGTH
UP TO: 380 FPS	9.0 INCHES	32.5 INCHES



TITAN[®] M1™

Measuring an ultra-compact 9-inches wide and shooting up to devastating speeds of 370 feet-per-second, the ultra-light Titan M1 offers an incredible performance-to-value ratio never seen before in the crossbow industry.

AVAILABLE FINISH



TRUETIMBER[®] VIPER



SPEED	WIDTH	LENGTH
UP TO: 370 FPS	9.0 INCHES	32.5 INCHES



AVAILABLE AS COMPLETE PACKAGES
SEE PAGES 10 & 11





	VAPOR RS470 SAFE DE-COCKING	NITRO XRT	VENGEANT S440 SAFE DE-COCKING	XR-410	VIPER S400 SAFE DE-COCKING	TURBO M1	TITAN M1
LENGTH (without foot stirrup)	31"	29.5"	35"	29.5"	32"	32.5"	32.5"
WIDTH - AXLE-TO-AXLE (uncocked / cocked)	12" / 6.5"	12" / 6.5"	11" / 5.8"	12" / 6.5"	11" / 7.2"	14" / 9"	14" / 9"
POWER STROKE	17"	17"	14"	17"	11"	14"	14"
DRAW WEIGHT	225	225	250	200	250	190	180
WEIGHT (without accessories)	8 lbs. (with ACUslide)	7.4 lbs.	7.7 lbs. (with ACUslide)	7.4 lbs.	7.5 lbs. (with ACUslide)	6.4 lbs.	6.4 lbs.

PERFORMANCE (FEET-PER-SECOND / FOOT-POUNDS KE)

PRO LITE ARROW (370-grains)	470 / 182	470 / 182	440 / 159	410 / 138	400 / 132	380 / 119	370 / 113
PRO ELITE 400 ARROW (400-grains)	460 / 188	460 / 188	430 / 164	400 / 142 (Supplied arrow speed / KE)	390 / 135	370 / 122 (Supplied arrow speed / KE)	360 / 115 (Supplied arrow speed / KE)
EVO-X CENTERPUNCH ARROW (445-grains)	440 / 191 (Supplied arrow speed / KE)	440 / 191 (Supplied arrow speed / KE)	410 / 166 (Supplied arrow speed / KE)	380 / 143	370 / 135 (Supplied arrow speed / KE)	350 / 121	340 / 114

ACCESSORIES (Included with package)

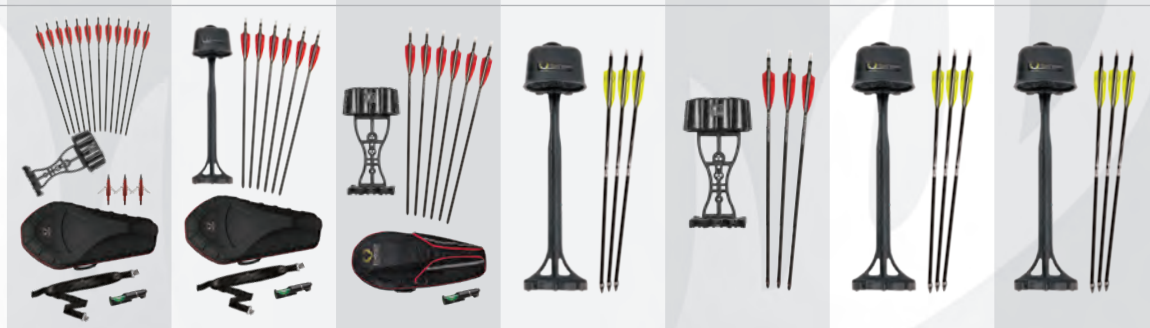

Tech Quiver 6 EVO-X Arrows 6 Lighted EVO-X Arrows 3 CenterPunch Broadheads STAG Hard Case Sling Bubble Level	Quiver 6 EVO-X Arrows STAG Hard Case Sling Bubble Level	Tech Quiver 6 EVO-X Arrows Blazer Soft Case Bubble Level	Quiver 3 Pro Elite 400 Arrows	Tech Quiver 3 EVO-X Arrows	Quiver 3 Pro Elite 400 Arrows	Quiver 3 Pro Elite 400 Arrows
--	---	---	----------------------------------	-------------------------------	----------------------------------	----------------------------------

PACKAGE NUMBERS

ACUslide & EVO-X Marksman Scope: Veil Alpine™: CB20004-6399 Graphite: CB20004-1399	ACUdraw PRO & EVO-X Marksman Scope: CB19005-2193	ACUslide & RangeMaster Scope: Veil Alpine™: CB20007-6219 Graphite: CB20007-1219	ACUdraw PRO & RangeMaster Pro Scope: CB20009-3513	ACUslide & RangeMaster Pro Scope: Veil Alpine™: CB20015-6819 Graphite: CB20015-1819	ACUdraw PRO & Pro-View Scope: CB19020-5523 ACUdraw 50 SLED & Pro-View Scope: CB19020-5527	ACUdraw & Pro-View Scope: CB19047-3522 Rope-Sled & Pro-View Scope: CB19047-3524
---	--	--	---	--	--	--



AMERICAN BUILT BY AMERICAN WORKERS

Put your hard-earned money to work with Wicked Ridge – the only American brand offering technologically driven crossbows at unbeatable prices.

PATENTED REVERSE-DRAW TECHNOLOGY

Creates an industry leading power stroke that generates more speed with less draw weight. Its elongated power stroke also increases the distance the arrow nock is engaged with the string – a critical component in performance, as the longer the nock remains engaged with the string, the more accurate the crossbow will be upon impact.



PATENTED NARROW CROSSBOW TECHNOLOGY

NEW for 2020, Wicked Ridge unveils the M-370 – with a width of only 9.5-inches, it is the narrowest Wicked Ridge ever.



BUILT-IN COCKING DEVICES

Wicked Ridge bows have multiple cocking device options including: ACUdraw PRO, ACUdraw, ACUdraw 50, and ACU-52.



NEW FOR 2020

M-370™

INTRODUCING THE WORLD'S
LIGHTEST CROSSBOW - 5.8-POUNDS.

The American-built M-370 is the industry's top value crossbow for 2020.

SPEED

UP TO:

370
FPS

WIDTH

9.5
INCHES

WEIGHT

5.8
POUNDS



ULTRA-NARROW



9.5-INCHES WIDE

ACUDRAW COCKING DEVICE

Built-in cocking device draws your crossbow accurately with only 5-pounds of effort. (optional)

GORDON GLASS LIMBS

Double laminated, Gordon Glass limbs provide unmatched durability compared to competitor's imported models.



T4 TRIGGER

Auto-engaging safety trigger features a Dry-Fire-Inhibitor™ (DFI) and an ultra-crisp 3.5-pound pull.



AVAILABLE AS COMPLETE PACKAGE
 SEE PAGE 16

AVAILABLE
 FINISH

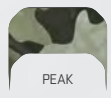

PEAK

RDX400™

The working man's reverse-draw crossbow, the RDX 400 features a perfectly balanced reverse-draw bow assembly and our Reaper Cam System™ that together deliver consistent down-range accuracy and lighting speeds up to 400 FPS. Focused on speed-to-price ratio, the RDX 400 includes a complete package with a cocking device and an Integrated String Stop System.

AVAILABLE FINISH

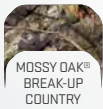

IMPROVED FOR 2020
ACUdraw PRO & Pro-View Scope

SPEED	WIDTH	WEIGHT
UP TO: 400 FPS	9.0 INCHES	7.6 POUNDS



NEW FOR 2020

INVADER®400

The next generation of the best-selling Wicked Ridge Invader model, the Invader 400 registers 400 FPS - an incredible 40 feet-per-second faster than its predecessor. Proudly built in America, it features a Pro-View lighted scope and a built-in cocking device for effortless cocking.

AVAILABLE FINISH

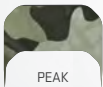

SPEED	WIDTH	WEIGHT
UP TO: 400 FPS	15.0 INCHES	6.0 POUNDS

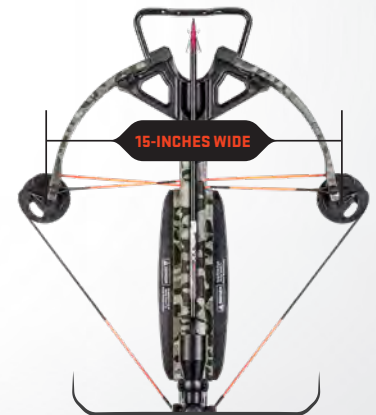

AVAILABLE AS COMPLETE PACKAGES
SEE PAGE 16

NEW FOR 2020

RAMPAGE 360™

The industry's first entry-level crossbow with a built-in cocking device, the all-new Rampage 360 shoots up to 360 feet-per-second and measures 15-inches wide. Delivering unmatched out-of-the-box accuracy and unparalleled American-built quality, it is the premiere entry-level crossbow on the market.



AVAILABLE FINISH

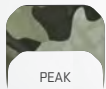

PEAK

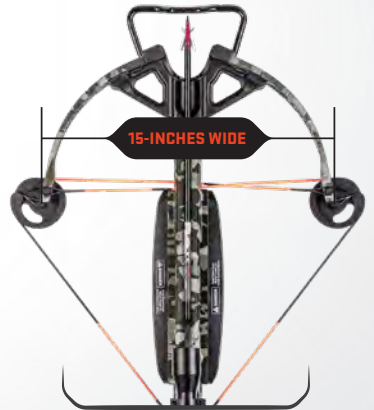

SPEED	WIDTH	WEIGHT
UP TO: 360 FPS	15.0 INCHES	6.0 POUNDS

RANGER® X2

Engineered to introduce crossbow hunting to youth, women, and small-framed shooters, the Ranger X2 features an easy-to-handle 150-pound bow assembly and 4S cams that produces 330 feet-per-second.



AVAILABLE FINISH



MOSSY OAK®
BREAK-UP
COUNTRY



SPEED	WIDTH	WEIGHT
UP TO: 330 FPS	16.0 INCHES	5.9 POUNDS

AVAILABLE AS COMPLETE PACKAGES
SEE PAGE 16

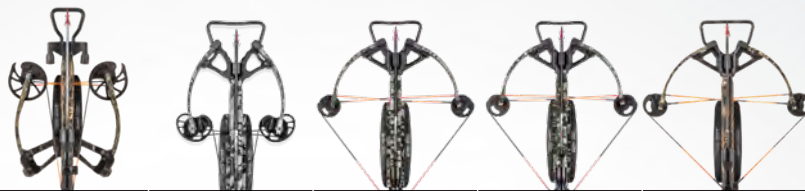

	RDX400	M-370	INVADER 400	RAMPAGE 360	RANGER X2
LENGTH (without foot stirrup)	32.25"	35"	35.5"	35.5"	33"
WIDTH - AXLE-TO-AXLE (uncocked / cocked)	15" / 9"	14" / 9.5"	19" / 15"	19" / 15"	19" / 16"
POWER STROKE	15.5"	13.8"	13.5"	13.5"	10.9"
DRAW WEIGHT	175	180	185	175	150
WEIGHT (without accessories)	7.6 lbs.	5.8 lbs.	6.0 lbs.	6.0 lbs.	5.9 lbs.

PERFORMANCE (FEET-PER-SECOND / FOOT-POUNDS KE)

RANGER ARROW (350-grains)	N/A	N/A	N/A	N/A	330 / 85 (Supplied arrow speed / KE)
PRO LITE ARROW (370-grains)	400 / 132	370 / 113	400 / 132	360 / 112	N/A
XX75 ALUMINUM ARROW (435-grains)	380 / 132 (Supplied arrow speed / KE)	350 / 118 (Supplied arrow speed / KE)	380 / 140 (Supplied arrow speed / KE)	340 / 112	N/A

ACCESSORIES (Included with package)



Quiver 3 XX75 Arrows	Quiver 3 XX75 Arrows	Quiver 3 XX75 Arrows	Quiver	Quiver 3 Ranger Arrows
-------------------------	-------------------------	-------------------------	--------	---------------------------

PACKAGE NUMBERS

ACUdraw PRO & Pro-View Scope: WR19060-5523	ACUdraw & Multi-Line Scope: WR20003-9532	ACUdraw & Pro-View Scope: WR20005-9522	ACUdraw & Multi-Line Scope: WR20015-9432	ACUdraw & Multi-Line Scope: WR19025-5532
ACUdraw PRO & Multi-Line Scope: WR19060-5532	Rope-Sled & Multi-Line Scope: WR20003-9534	ACUdraw 50 & Pro-View Scope: WR20005-9521	ACUdraw 50 & Multi-Line Scope: WR20015-9431	ACU-52 & Multi-Line Scope: WR19025-5536
Rope-Sled & Multi-Line Scope: WR19060-5534				



COCKING DEVICES TO MEET YOUR BOWHUNTING NEEDS

GEAR ASSISTED COCKING DEVICES - ACUDRAW PRO & ACUDRAW

Fully integrated into the stock, with no dangling parts, they require only the strength of the average person's index finger to operate. The ACUdraw PRO and ACUdraw allow hunters of all ages and physical abilities to enjoy the great experience of bowhunting.

HCA-001-PRO ACUdraw PRO

HCA-000-B-AD ACUdraw



ACUDRAW PRO

- Reduces draw weight to roughly 9-pounds
- Silent operation
- Auto-engage lever activates the gear system immediately as cranking begins
- Draws the bow accurately every time
- ACUtorq handle sold separately
- Available as an accessory or pre-installed on certain models (not for use on pre-2018 Wicked Ridge crossbows)

ACUDRAW

- Reduces draw weight to about 5-pounds when operated manually
- Lightweight and has no bulky clamp-on accessories
- Draws the bow accurately every time
- Available as an accessory or pre-installed

INTEGRATED ROPE-COCKING DEVICES - ACUDRAW 50 SLED & ACUDRAW 50

Fully integrated into the stock, the ACUdraw 50 SLED and ACUdraw 50 have taken the leveraged, 50% reduction rope-cocking concept to an easy-to-use level. Their cord/ropes retract neatly inside the unit's housing after cocking. Lightweight, contoured covers provide improved security of the unit and its cord/ropes when not in use. No storing a cocking rope, untangling it, or putting it away after each use.

- Draw the bow accurately every time
- Reduces draw weight by 50%
- No longer a need to hang a rope around your neck or to stash it in your fanny pack
- When not in use, powerful mini-magnets hold the detachable handles securely and silently in place
- Available as an accessory or pre-installed



ACUDRAW 50 SLED (PATENTED)

The ACUdraw 50 SLED contains a sled with detachable, magnetic handles that is compatible with most TenPoint crossbows with Functionally Superior Bullpup (FSB) stocks.

HCA-000-A50-S ACUdraw 50 SLED
(Not for use on Nitro X, Nitro XRT, and XR-410)

ACUDRAW 50 (PATENTED)

Compatible with most TenPoint and Wicked Ridge crossbows (not compatible with ultra-narrow or reverse-draw crossbows).

HCA-000-A50 ACUdraw 50
(Not for use on ultra-narrow or reverse-draw crossbows)



RETRACTABLE ROPE-COCKING DEVICES - ACUSLED

The ACUSled is a revolutionary, portable, retractable crossbow rope cocking device. It reduces the risk of inaccurate cocking that can occur with traditional rope-cockers, and thus, improve a shooter's accuracy.

- Reduces the draw weight by 50%
- Draw cord completely retracts inside one of the two grips
- Clever, convenient, and user-friendly
- Draws the bow accurately every time
- Draw cord is pound-for-pound 15-times stronger than steel
- Lightweight and affordable



HCA-000-AS ACUSled (Not for use on Nitro X, Nitro XRT, and XR-410)

REVOLUTIONARY ALPHA-NOCK AND ALPHA-BRITE LIGHTED NOCK SYSTEM

DESIGNED FOR INCREASED STRING-TO-NOCK ENGAGEMENT AND SAME HOLE DOWN-RANGE ACCURACY.

TenPoint's Alpha-Nock features a deep bowstring groove, a large smooth radius base, and elongated ears. The string on TenPoint's extremely narrow crossbows wraps tightly around the center of the Alpha-Nock resulting in straight nock travel and precision down-range accuracy, while minimizing string serving wear.

The Alpha-Nock's deep groove and large radius base "holds" the bowstring in place on extremely narrow crossbows to prevent "shoot-over" or "shoot-under".

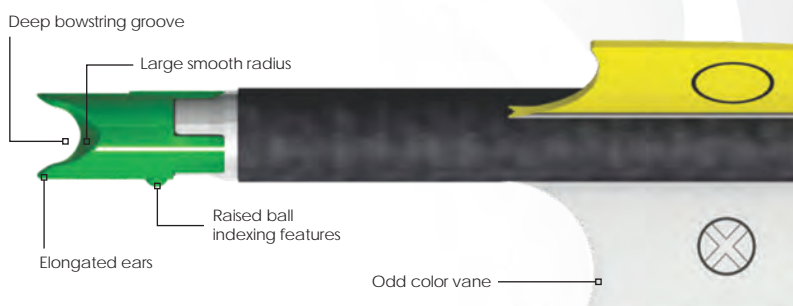

LIGHTED NOCK SYSTEM

28% Increased String-to-Nock Engagement

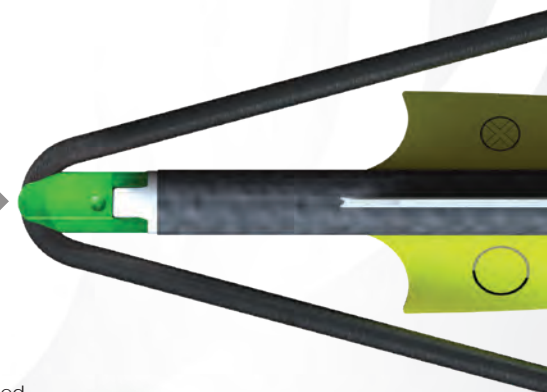

ALPHA-BRITE LIGHTED NOCK SYSTEM

The three-piece, Alpha-Brite Lighted Nock System begins with a Nock-Receiver insert with a six-sided interior cavity designed to accept a combined LED unit and translucent pegged Alpha-Brite Nock. The Nock Receiver is glued into the nock-end of the arrow and indexed with the vanes.

To complete the Alpha-Brite installation, insert the LED unit - lighted end first - into the peg end of the Alpha-Brite nock and insert the nock and LED unit into the Nock Receiver. Then, insert the nock tabs between the receiver's locking clips until you hear/feel it "click" into place. When you fire your crossbow, the bowstring's force will compress the two pieces, eliminate the gap, and activate the LED unit.

To deactivate the Alpha-Brite system, remove the nock and LED unit, and pull the lighted end of the LED unit until the light turns off. The LED unit's battery should last for approximately eight hours.

NOTE: BE SURE THE ALPHA-NOCK'S RAISED BALL INDEX FEATURE IS PROPERLY ALIGNED WITH THE COCK VANE (ODD COLORED) ON YOUR ARROW.

*All TenPoint crossbows and Wicked Ridge crossbows require the use of an Alpha-Nock Arrow. Failure to do so will void the manufacturer's warranty.

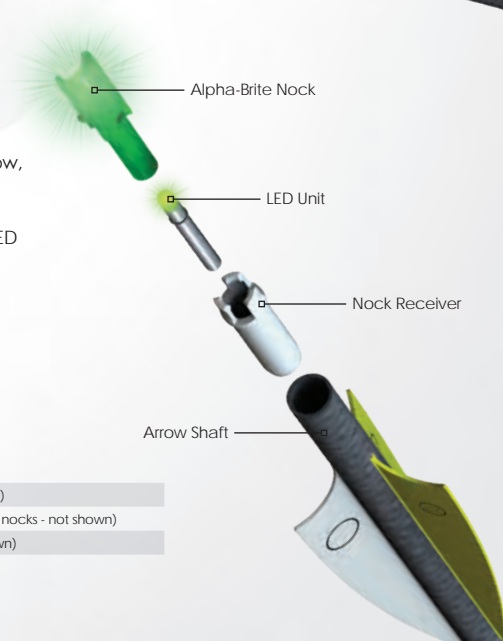

HEA-358.3	3-pack Alpha-Brite Lighted Nock System - Green (not shown)	HEA-310.3	3-pack (red LED lite sticks - not shown)
HEA-312.3	3-pack (green LED lite sticks - not shown)	HEA-352.6R	6-pack (red Alpha-Brite replacement nocks - not shown)
HEA-352.6G	6-pack (green Alpha-Brite replacement nocks - not shown)	HEA-352.6W	6-pack (white Alpha-Nocks - not shown)
HEA-358R.3	3-pack Alpha-Brite Lighted Nock System - Red (not shown)		



EVO-X CENTERPUNCH CARBON ARROW

445-GRAINS / BALANCED AT 17% FOC / .001" STRAIGHTNESS

The most accurate crossbow arrow ever, the CenterPunch 20-inch arrow is fletched slightly offset and is fitted with an 84-grain insert and TenPoint's Aluminum or white Alpha-Nock and receiver for quick lighted nock installation. Constructed from modulus carbon fiber at 33 MSI (million-pounds-per-square-inch) and wrapped in an exclusive LAZER-TECH carbon weave, it is fletched with 3.5" Bohning X Vanes™. CenterPunch arrows are inspected for straightness to within .001 and each package is weight-grain matched within 1-grain per arrow.

HEA-742.6	6-pack (w/aluminum Alpha-Nock)
HEA-740.6	6-pack (w/Alpha-Nock)
HEA-748.3	3-pack (Alpha-Nock lighted arrows)

*All 3- and 6-packs come with 100-grain field points



NEW

PRO ELITE 400 CARBON ARROW

400-GRAINS / BALANCED AT 14% FOC / .003" STRAIGHTNESS

The Pro Elite 20-inch carbon arrow is fletched slightly offset and is fitted with a 61-grain aluminum insert, 3.5" Bohning X Vanes™ and TenPoint's white Alpha-Nock and receiver for quick lighted nock installation. Pro Elite shafts are inspected for straightness to within .003 and hand-sorted for weight tolerance to within 2-grains per dozen.

HEA-660.3	3-pack (w/Alpha-Nock)
HEA-660.6	6-pack (w/Alpha-Nock)
HEA-660.72	72-pack (w/Alpha-Nock)
HEA-668.3	3-pack (Alpha-Brite lighted arrows)
HEA-668.6	3-pack (Alpha-Brite lighted arrows)
HEA-668.72	72-pack (Alpha-Brite lighted arrows)

*All 3- and 6-packs come with 100-grain field points



NEW

XX75 WICKED RIDGE ALUMINUM ARROW

435-GRAINS / BALANCED AT 9% FOC / .003" STRAIGHTNESS

The XX75 20-inch 2219 aluminum arrow is fletched slightly offset and is fitted with a 13-grain aluminum insert, 2.0" Easton Bully Boattail Vane and TenPoint's white Alpha-Nock.

HEA-060.3	3-pack (w/Alpha-Nock)
HEA-060.6	6-pack (w/Alpha-Nock)
HEA-060.72	72-pack (w/Alpha-Nock)
HEA-068.3	3-pack (Alpha-Brite lighted arrows)

*All 3- and 6-packs come with 100-grain field points



PRO LITE CARBON ARROW

370-GRAINS / BALANCED AT 10.5% FOC / .003" STRAIGHTNESS

The Pro Lite 20-inch carbon arrow is fletched slightly offset and is fitted with a 25-grain aluminum insert, 3.5" Bohning X Vanes™ and TenPoint's white Alpha-Nock. Pro Lite shafts are inspected for straightness to within .003 and hand-sorted for weight tolerance to within 2-grains per dozen.

HEA-460A.6	6-pack (w/Alpha-Nock)
HEA-468A.3	3-pack (Alpha-Brite lighted arrows)

*All 3- and 6-packs come with 100-grain field points



WICKED RIDGE RANGER CARBON ARROW

370-GRAINS / BALANCED AT 15% FOC / .003" STRAIGHTNESS

The Ranger 18-inch carbon arrow is fletched slightly offset and is fitted with a 15-grain aluminum insert, 3.5" Bohning X Vanes™ and white Alpha-Nock.

NOTE: the Ranger arrow is for use with Wicked Ridge Ranger models only.

HEA-260.6	6-pack (w/Alpha-Nock)
-----------	-----------------------

*All 3- and 6-packs come with 100-grain field points



NEW

CROSSBOW DISCHARGE ARROW

725-GRAINS

The Crossbow Discharge Arrow includes a 20-inch carbon arrow with an installed Alpha-Nock, discharge collar, and field tip. The 725-grain finished arrow with an Alpha-Nock, is designed for use on most crossbows that shoot a 20-inch arrow. It can also be used on most crossbows requiring flat, moon, or capture nocks.

HEA-00018	Crossbow Discharge Arrow
-----------	--------------------------

CROSSBOW CASES

HARD CASES

Designed for maximum protection and durability, these rigid, water-resistant cases feature an extremely durable shell, as well as a velvet interior for added protection. The interior of the case includes two hook and loop straps to secure the crossbow during travel, and storage for a quiver that also includes straps. If used with TSA approved locks, the case is TSA compliant.



HCA-20318 TenPoint STAG Case / Black / Fits all of TenPoint's 2019 and newer crossbow line-up
DIMENSIONS: Case Length: 36.75" (not including foot stirrup pass-thru) / Case Width: 18" / Case Depth: 10.75" / Interior Length: 36.25" / Interior Width: 17.5" / Interior Depth: 10.25"

SOFT CASES

These ultra-durable soft cases ensure protection needed for travel and/or storage of your crossbow. They contain deep, sturdy side panels to accommodate mounted optics, adjustable carry strap(s), and zippered compartment(s) for accessories.



HCA-20T19 Blazer Soft Case / Black / Fits all of TenPoint's 2019 and newer crossbow line-up
DIMENSIONS: Case Length: 40.5" / Case Width: 18.5" / Case Depth: 10.75"

NEW
WRA-220

Wicked Ridge Soft Crossbow Case / Black / Fits 2018 and newer Wicked Ridge crossbows (except Ranger and Lady Ranger models)
DIMENSIONS: Case Length: 38" / Case Width: 22.5" / Case Depth: 10.75"

CROSSBOW ACCESSORIES

CENTERPUNCH BROADHEAD

Designed for strength, the 100-grain, rear-deploying EVO-X CenterPunch Broadhead features collarless design that delivers field point accuracy and a devastating 1 7/8" cut. Its 7075 T6 aluminum ferrule, ultra-strong precision point, and scalpel sharp blades stay closed during flight – creating massive wound channels and leaving huge blood trails.



HEA-800 CenterPunch Broadhead (3-pack)



NEOPRENE SLINGS

Featuring an extra-strong 1.25-inch wide shoulder strap, thumb loop, and a non-slip design. Equipped with custom swivels and heavy-duty adjustable strap.

HCA-004 TenPoint
WRA004 Wicked Ridge

NEW

READY TO HUNT ACCESSORY PACKAGES

Featuring all of the "must-have" accessories needed for the hunt. The kits contain a 3-pack lightednock kit, 3 100-grain CenterPunch Broadheads, sling, Premium Lubricant with Foam Applicator, and tube of String Wax and Conditioner.



HCA-1111T TenPoint Ready to Hunt Accessory Package (shown)
HCA-1111W Wicked Ridge Ready to Hunt Accessory Package (not shown)



STEDDYEDDY® (PATENTED)

The SteddyEddy telescoping two-section monopod ensures motion-free shooting while seated or standing. It attaches directly to your crossbow using a 360-degree maneuverable rapid-pivot tube equipped with a snap-on connection and clamps under your stock when not in use.

HCA-030 SteddyEddy Crossbow Monopod System (compatible with TenPoint and Wicked Ridge crossbows)

MAINTENANCE

TENPOINT STRING WAX AND CONDITIONER

Made from all-natural compounds. Comes in a convenient chap-stick style tube. Lubricates and rejuvenates bow strings & cables.

HCA-11007 TenPoint String Wax and Conditioner

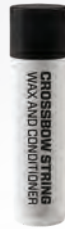

LUBRICANTS

Unlike other manufacturers' gel-based lubricants, will not gum-up in cold weather or collect dirt and grime. Recommended for strings, cables, cocking device cords, and barrel. Both feature Scorpion Venom™ Premium Lubricant.

HCA-111 Flight Rail and Trigger Lube (tube)

HCA-112 Premium Lubricant with Foam Applicator (bottle)



SILENCERS

NOISE DAMPENING PACKAGES

Private labeled exclusively for TenPoint by Bowjax, Inc. the Noise Dampening packages progressively reduce decibel level and shorten noise duration when used on compound crossbows and/or vertical bows. Two versions are available:



HCA-13617 Noise Dampening Package (Includes limb, retention spring foot stirrup, and barrel dampeners)

HCA-13718 Universal Limb and Foot Stirrup Silencing Package (Includes limb & foot stirrup dampeners only, for most compound crossbows and/or vertical bows)



STRING DAMPENING SYSTEMS (SDS)

Featuring micro-adjustable dampening rods with durable, high impact rubber dampeners the SDS mounts in the cable slot to dramatically reduce string noise and oscillation. Compatible with most post-1999 TenPoint Crossbow Technologies thumbhole models except the GT Curve™. Also compatible with most pre-2015 Wicked Ridge crossbows, all Raider CLS and Warrior HL models, and Horton Legend Ultra Lite™ crossbows. Not compatible with RDX or NXT crossbows, RCX crossbows with built-in dampeners, Wicked Ridge Invader X4, Invader G3, Warrior Ultra-Lite, Warrior G3, Ranger or Lady Ranger models.



HCA-148

HCA-148 SDS (String Dampening System) A second set of SDS rods are included to alleviate the need for shortening rods. Compatible with Turbo M1, Titan M1, and M-370 crossbows.

HCA-146 Wicked Ridge SDS (String Dampening System) Compatible only with the Invader 400, Invader X4, Rampage 360, Warrior Ultra-Lite, and Ranger X2.



HCA-146

SCOPES

EVO-X® MARKSMAN™ SCOPE

The brightest and most accurate crossbow scope on the market, the Marksman Scope features a patented, variable speed locking ring, as well as fully multi-coated 1.5-6x optics. Its configuration consists of five illuminated duplex crosshairs calibrated for 10-yard increments between 20- and 60-yards, and two chevrons at 70- and 80-yards for competition and recreational shooting. The scope is outfitted with quick-detach scope rings, a bubble level, and high-quality flip-up scope caps. An infinite-position rheostat controls the light intensity of the red and green illuminated crosshairs.



HCA-095 EVO-X Marksman Scope with 7/8" quick-detach mounting rings and flip-up scope caps

RANGEMASTER® PRO SCOPE

This 8.25-inch aluminum scope features a variable speed and arrow drop-compensation setting for crossbows, and requires no adjustment for distance. Three duplex crosshairs and four dots calibrated for 20-, 30-, 40- and 50-yards, and a triangle for 60-yards (fourth dot and triangle are free-standing, just below the 40-yard crosshair) are available with a non-illuminated black dot or one of two rheostat controlled illuminated, colored dots (red or green). An etched glass reticle and fully multi-coated 1.5 to 5x optics reduce the loss of light transmission, while a 30mm tube heightens light-gathering and durability.



HCA-09811 RangeMaster Pro Scope with 7/8" mounting rings and flip-up scope caps

PRO-VIEW™ SCOPE

This lightweight 8.5-inch aluminum tube scope features 3 crosshairs and four dots calibrated for 20-, 30-, 40-, and 50-yards (fourth dot is free-standing, just below the 40-yard crosshair) and fully-coated 3x optics. Available with non-illuminated black dots or one of two rheostat controlled illuminated, colored dots (red or green).



HCA-097-II Pro-View Scope with 7/8" mounting rings

MULTI-LINE SCOPE

Only 8.5-inches long, this compact scope features fully coated 3x optics and three duplex crosshairs calibrated for 20, 30, and 40-yards, and a fourth partial line for 50-yard shots. Scope mounting rings included.



HCA-090 Multi-Line Scope with 7/8" mounting rings

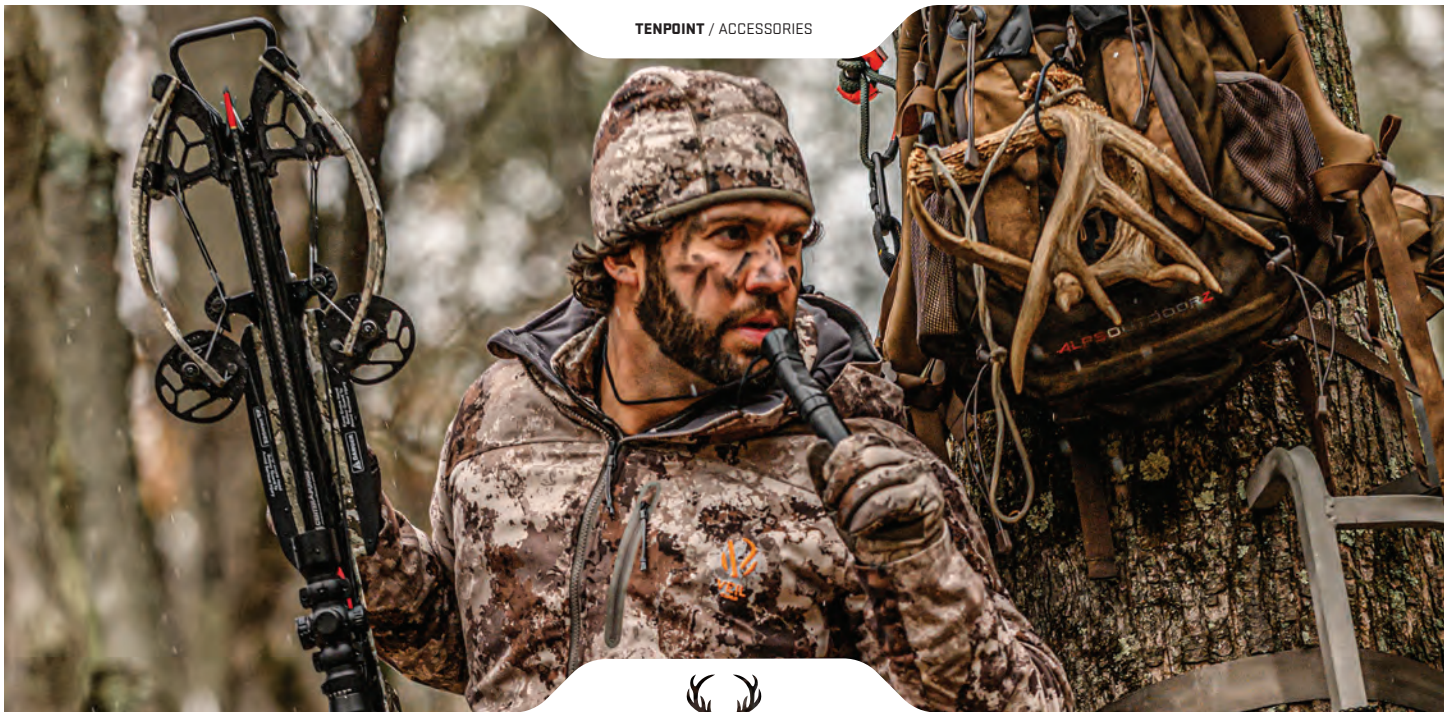

NEW

6-ARROW TECH QUIVER

The NEW compact Tech quiver contains a rigid ultra-durable spine and is designed for easy ambidextrous mounting. It's grippers hold up to four arrows with broadheads and/or field points on the front of the quiver, and two additional arrows with field points can be stored on the back of the quiver for a total of up to six arrows. Mounting hardware is included.



HCA-01920 6-Arrow Tech Quiver

DOVETAIL BUBBLE LEVEL

The bubble level can be attached to any weaver-style dovetail to provide added accuracy, especially at longer distances.



HCA-073 Dovetail Bubble Level

NEW

XTEND ADJUSTABLE CRANK HANDLE

The NEW XTEND Crank Handle starts at a compact 5-inches long and extends to its user-friendly length of 7.5-inches. When extended to its full length, the crank handle decreases the cocking effort by approximately 45% over the standard crank handle on all TenPoint gear-assisted cocking devices. Also includes parts to convert the XTEND Adjustable Crank Handle from a square drive to a hex drive for use on ACUdraw PRO or ACUdraw units.



HCA-446 Xtend Adjustable Crank Handle

BEDNAR PERFECT PULLER® (PATENTED)

Named for and originally developed by the Hall of Fame Archer Bill Bednar, this tool is designed to pull arrows from high-density targets. Includes three interchangeable grippers sized to fit different shaft diameters of both crossbow and compound arrows. In addition, the hunter orange handles are notched to create a built-in nock tool.



HCA-104 Bednar Perfect Puller (with interchangeable grippers)

ACUDRAW/ACUDRAW 50/ACU-52 REPLACEMENT ACCESSORIES

APPAREL

TENPOINT AND WICKED RIDGE APPAREL

GRIPGUARD™ (PATENTED)

The GripGuard is a shield that custom fits over post-1999 through 2013 TenPoint synthetic stock model fore-grips with or without a GripSafety. The wings at the top of the shield help prevent a shooter's fore-grip fingers and/or thumb from dangerously migrating above the flight deck while shooting the crossbow.



HCA-10014 Molded GripGuard / Black



2020 STRING AND CABLE REFERENCE GUIDE

The following models require a complete upgrade.

TENPOINT

MODELS	STRINGS	CABLES
Turbo Extreme & Magnum Extreme	HCA-115	HCA-124
Elite X2, Magnum X2, Stealth X2, & Turbo X2	HCA-115	HCA-124
Hybrid Lite & Elite Lite	HCA-115	HCA-124
Pro Fusion, Pro Slider, Titan TL-9, & Titan HLX	HCA-115	HCA-124
Pro Elite, Elite, Elite QX-4, & QX-4	HCA-115	HCA-124
Maverick HP, Pro Elite HP, Blazer HP, & Lazer HP	HCA-115	HCA-124
Phantom Xtra, Phantom CLS, Shadow CLS, Defender CLS, Carbon Xtra CLS, & Carbon Fusion CLS	HCA-11607	HCA-12307
Stealth XLT & Turbo XLT	HCA-12110	HCA-12710
Turbo XLT II, Carbon Elite XLT, & Stealth SS	HCA-12112	HCA-12912
Shadow Ultra-Lite, Tactical XLT, Turbo GT & Renegade XLT	HCA-12112-R	HCA-12912-R
Titan Xtreme	HCA-11712	HCA-12612
GT Curve, GT Flex, & GT Mag	HCA12008	N/A
Vapor	HCA-11813	HCA-12813
Venom	HCA-12014	HCA-12514
Lady Shadow	HCA-12115-P	HCA-12915-P
Stealth FX4 & Venom Xtra	HCA-12015-O	HCA-12515-O
Titan SS & Renegade	HCA-11716-S	HCA-12616-S
Carbon Nitro RDX	HCA-12216-R	HCA-13116-R
Carbon Phantom RCX & Eclipse RCX	HCA-70117	HCA-70017
Vengent S440, Viper S400, Stealth NXT, & Shadow NXT	HCA-70317	HCA-70217
Vapor RS470, Nitro XRT, Nitro X, & XR-410	HCA-70717	HCA-70617
Turbo M1 & Titan M1	HCA-11619-S	HCA-11619-C

HORTON

MODELS	STRINGS	CABLES
Storm RDX	HCA-12215	HCA-13115
Vortec RDX	HCA-72717	HCA-72617
Legend Ultra Lite	HCA-11915	HCA-13015

WICKED RIDGE

MODELS	STRINGS	CABLES
Invader HP, Invader, Warrior HL, & Warrior	WRA182	WRA162
Raider CLS	WRA183	WRA163
Ranger	HCA-13215-O	HCA-13315-O
Lady Ranger	HCA-13215-P	HCA-13315-P
Invader G3 & Warrior G3	HCA-13216-OB	HCA-13316-OB
Invader 400, Rampage 360, Invader X4, Warrior Ultra-Lite, & Ranger X2	HCA-75117	HCA-75017
RDX 400	HCA-13419-S	HCA-13419-C
M370	HCA-11619-S	HCA-11619-C



BUILT IN AMERICA
MOGADORE, OHIO

We design, build, and test our crossbows here in the U.S.A. Doing so enables us to control the process and to use the best parts and materials available, thereby guaranteeing a final product of uncompromising quality.

Our rigorous testing standards have earned us a reputation for making some of the most durable and dependable products on the market. We validate all of our designs through a prototyping process that combines hands-on testing with automated cycle testing.

Our automated shooting simulator allows us to put thousands of shots on our bow assembly designs in a matter of days — so when the final product arrives on the shelves, it will meet your expectations.



Check out an excellent selection of archery we offer on our website.