



2017V2

Innovation, Quality and Service

TACO Marine is a division of TACO Metals, Inc.. We are a family owned and operated company established over five decades ago that has steadily grown to become a global leader in the recreational marine industry while still maintaining our strong family values and commitment to serving our customers' needs. Today, the TACO Marine brand includes a wide selection of products from Rub Rail, Canvas and Tower Hardware to Sport Fishing Equipment, Seating Products and Specialty Custom Hardware.

We strive to deliver Innovation, Quality and Service in everything we do which is why boat builders, marine fabricators, distributors, dealers and repair yards all rely on TACO Marine products to meet their design and performance needs. This combined with our large on-hand inventory, same or next day shipping and dedicated service and technical support make TACO Marine a complete solutions provider well positioned to serve our customers for many more years to come.



TACO Metals, Inc.
Sparta, TN



Vinyl Extruding &
CNC Machining



Warehousing &
Distribution



Delivery
Service

TABLE OF CONTENTS

SEATS & PEDESTALS	SP2
Leaning Posts	SP3
Helm Chairs	SP6
Pedestals	SP10
SPORT FISHING	SF18
Outrigger Mounts	SF19
Tele-Outrigger Poles	SF24
Outrigger Kits	SF26
Rod Holders & Storage	SF30
MARINE FABRICATION (CANVAS & METAL)	MF40
Canvas Top Fittings	MF41
Rail Fittings	MF48
Tube & Pipe	MF49
Top & Tower Hardware	MF53
RUB RAIL	RR60
Rigid & Semi-Rigid Vinyl	RR61
Flexible Vinyl	RR68
Rub Rail Kits	RR70
Aluminum	RR72
Custom Pre-Formed	RR74
Inserts	RR75
TRIM & MOULDING	TM80
Weather Seals	TM81
Vinyl Moulding	TM82
Aluminum Moulding	TM84
HINGES & LATCHES	HL88
Continuous Hinges	HL89
Deck Hinges	HL90
Specialty Hinges & Latches	HL92
MARINE ACCESSORIES	MA96
Dockside	MA97
LED Lights	MA100
Marine Lumber	MA106
REFERENCE / WARRANTY INFORMATION	REF108
INDEX	IND112



SEATS & PEDESTALS





Neptune II Leaning Post

Neptune II Leaning Post

Aluminum Anodized

- > Aluminum frame, high polished anodized finish
- > Grab Rail included
- > Four Aluminum Rod Holders included
- > Secure seat latch
- > Removable large capacity, stay-dry synthetic, soft pack storage included (also sold separately)
- > Folding footrest
- > 72qt cooler storage area with strap
- > Cooler storage area: 24-1/2"H x 29-1/4"W
- > Continuous flat bar mounting pads
- > Mildew, fungus and UV-resistant
- > Shipping compliant packaging
- > Footprint: 14" x 35"
- > Ideal for up to 25' boats

Patent #7,819,483



Removable Neptune Tackle Storage Bag in tear-resistant, carbon gray fabric, keeps gear and tackle dry. Plenty of pockets to conveniently store all your gear.



SOLD SEPARATELY

Universal Leaning Post Backrest (pg SP16)

Leaning Post Cooler Strap (pg SP17)



Part #	Description	Height*	Width	Depth†
L10-1003-1	Neptune II Leaning Post w/Removable Tackle Storage Bag	32-1/2"	35"	26"

*Closed seat †Footrest down



LEANING POSTS

Neptune III Leaning Post

Aluminum Anodized

- > Aluminum frame, spiral sanded, bright dip anodized finish
- > Folding footrest
- > One-piece welded frame construction made from marine-grade Aluminum
- > Seat cushions constructed with marine-grade Vinyl, foam and PVC board substrate
- > Anti-warp and anti-rot
- > Mildew, fungus and UV-resistant
- > 72qt cooler storage area with strap
- > Cooler storage area: 24-1/2"H x 29-1/4"W
- > Shipping compliant packaging
- > Footprint: 15-3/8" x 35-1/2"
- > Ideal for up to 25' boats

L10-2005BSA-1

- Poly Rod Holders included

L10-2010BSA-1

- Aluminum Tulip Rod Holders included
- Backrest with Clamp-on Grab Rail included



Neptune III Leaning Post

Neptune III
TACO MARINE



L10-2005



L10-2010

SOLD SEPARATELY

Leaning Post Cooler Strap
(pg SP17)



Part #	Description	Height	Width	Depth*
L10-2005BSA-1	Neptune III Leaning Post w/Smooth Upholstery	32"	35-1/2"	23"
L10-2010BSA-1	Neptune III Leaning Post w/Backrest, Grab Rail	45"	39"	24-1/2"

*Closed seat *Backrest †Footrest down



TACO
MARINE



Neptune Premium Leaning Post



Neptune Premium Leaning Post

Aluminum Anodized

- > Aluminum, high polished anodized finish frame
- > Removable fiberglass storage tray
- > Four flush-mounted Aluminum Rod Holders
- > Folding footrest
- > Wrap around Grab Rail
- > 72qt cooler storage area with strap
- > Cooler storage area: 24-1/2"H x 29-1/4"W
- > Hand-laid fiberglass deck
- > Anodized after fabrication - no painted welds or crazing around bends
- > Continuous flat bar mounting pads
- > Mildew, fungus and UV-resistant
- > Easy assembly
- > Shipping compliant packaging
- > Footprint: 15-1/2" x 35"
- > Ideal for up to 30' boats

SOLD SEPARATELY

Universal Leaning Post Backrest (pg SP16)

Leaning Post Cooler Strap (pg SP17)



Part #	Description	Height*	Width*	Depth*
L10-1001-1	Neptune Premium Leaning Post w/Fiberglass Storage	33-1/2"	39"	27"

*Closed seat *Grab rail *Footrest down



HELM CHAIRS

Capri Helm Chair

Deluxe

- > "Deluxe" includes adjustable armrests and bolster (except for 23" chair)
- > Premium quality marine-grade Vinyl fabrics treated with anti-microbial and UV stabilizers
- > Plush foam padding provides durable support
- > Flexible, ergonomic design
- > Meets ABYC H-31 impact test
- > Stainless Steel cast armrest brackets
- > Stainless Steel rollback seat hinge with shield
- > Durable fiberglass seat back
- > Rollback seat bolster for quick repositioning and helm access
- > Optional Seat Slide sold separately
- > Custom Vinyl options available for boat builders
- > Ideal for up to 50' boats



Capri Helm Chair



PRODUCT KNOWLEDGE



All Helm chairs come with durable, Fiberglass seat back.



OPTIONAL

Low Profile Seat Slide (pg SP16)



NOTE:
Requires conversion plate for 19", 20" and 23" chairs

COLOR GUIDE*

Lt. Gray

Vanilla

White

Black

*Due to variations in the printing process, color guide may vary slightly from the original product. Color sample available upon request.

Part #	Description	"A"	"B1"	"B2"	"C"
HA2-23GRA-7-0000-0-0	23" Capri Chair w/o Armrest, Lt. Gray	23"	21"	12"	24"
HA2-23IVA-7-0000-0-0	23" Capri Chair w/o Armrest, Vanilla	23"	21"	12"	24"
HA2-23WHA-7-0000-0-0	23" Capri Chair w/o Armrest, White	23"	21"	12"	24"
HA2-23BKA-7-0000-0-0	23" Capri Chair w/o Armrest, Black	23"	21"	12"	24"
HA1-25GRA-7-0000-0-0	25" Capri Chair, Lt. Gray	25"	21"	12"	25"
HA1-25IVA-7-0000-0-0	25" Capri Chair, Vanilla	25"	21"	12"	25"
HA1-25WHA-7-0000-0-0	25" Capri Chair, White	25"	21"	12"	25"
HA1-25BKA-7-0000-0-0	25" Capri Chair, Black	25"	21"	12"	25"
HA1-28GRA-7-0000-0-0	28" Capri Chair, Lt. Gray	28"	21"	12"	25"
HA1-28IVA-7-0000-0-0	28" Capri Chair, Vanilla	28"	21"	12"	25"
HA1-28WHA-7-0000-0-0	28" Capri Chair, White	28"	21"	12"	25"
HA1-28BKA-7-0000-0-0	28" Capri Chair, Black	28"	21"	12"	25"
Bench					
HA1-36GRA-7-0000-0-0	36" Capri Bench, Lt. Gray	36"	21"	12"	25"
HA1-36IVA-7-0000-0-0	36" Capri Bench, Vanilla	36"	21"	12"	25"
HA1-36WHA-7-0000-0-0	36" Capri Bench, White	36"	21"	12"	25"
HA1-36BKA-7-0000-0-0	36" Capri Bench, Black	36"	21"	12"	25"
HA1-40GRA-7-0000-0-0	40" Capri Bench, Lt. Gray	40"	21"	12"	25"
HA1-40IVA-7-0000-0-0	40" Capri Bench, Vanilla	40"	21"	12"	25"
HA1-40WHA-7-0000-0-0	40" Capri Bench, White	40"	21"	12"	25"
HA1-40BKA-7-0000-0-0	40" Capri Bench, Black	40"	21"	12"	25"



TACO
MARINE



Capri Helm Chair

Capri Helm Chair

Standard

- > Includes armrests with fixed seat bottom (except for 23" chair)
- > Premium quality marine-grade Vinyl fabrics treated with anti-microbial and UV stabilizers
- > Plush foam padding provides durable support
- > Flexible, ergonomic design
- > Meets ABYC H-31 impact test
- > Stainless Steel cast armrest brackets
- > Optional Seat Slide sold separately
- > Custom Vinyl options available for boat builders
- > Ideal for up to 50' boats



OPTIONAL

Low Profile Seat Slide (pg SP16)



NOTE:
Requires conversion plate for 19", 20" and 23" chairs)

COLOR GUIDE*

Lt. Gray

Vanilla

White

Black

*Due to variations in the printing process, color may vary slightly from the original product. Color sample available upon request.

Part #	Description	"A"	"B"	"C"
HA21-23GRA-0000-0-0	23" Capri Chair w/o Armrest, Lt. Gray	23"	21"	24"
HA21-23IVA-0000-0-0	23" Capri Chair w/o Armrest, Vanilla	23"	21"	24"
HA21-23WHA-0000-0-0	23" Capri Chair w/o Armrest, White	23"	21"	24"
HA21-23BKA-0000-0-0	23" Capri Chair w/o Armrest, Black	23"	21"	24"
HA11-25GRA-0000-0-0	25" Capri Chair, Lt. Gray	25"	21"	25"
HA11-25IVA-0000-0-0	25" Capri Chair, Vanilla	25"	21"	25"
HA11-25WHA-0000-0-0	25" Capri Chair, White	25"	21"	25"
HA11-25BKA-0000-0-0	25" Capri Chair, Black	25"	21"	25"
HA11-28GRA-0000-0-0	28" Capri Chair, Lt. Gray	28"	21"	25"
HA11-28IVA-0000-0-0	28" Capri Chair, Vanilla	28"	21"	25"
HA11-28WHA-0000-0-0	28" Capri Chair, White	28"	21"	25"
HA11-28BKA-0000-0-0	28" Capri Chair, Black	28"	21"	25"



HELM CHAIRS

Captiva Helm Chair

- > Ergonomic design for maximum comfort on long trips
- > Available in White
- > Durable marine grade components and materials
- > Built to meet H31 seat category requirement
- > 23" size allows multiple chairs side by side
- > Pleated inserts provide a stylish look
- > Folding armrests and hinged bolster pad standard features
- > Polished stainless hardware and non-wood construction
- > Custom two-tone options available: White base with color insets or color welt and piping



Captiva Helm Chair Custom Two-Tone



Part #

Description

"A"

"B"

"C"

HA3-23WHA-0000-0-0

23" Captiva Chair, White

23"

21"

23"



Coastal Helm Chair

Coastal Helm Chair

- > Premium quality marine-grade Vinyl fabrics treated with anti-microbial and UV stabilizers
- > Plush foam padding provides durable support
- > Flexible, ergonomic design
- > Meets ABYC H-31 impact test
- > Stainless Steel Type 316 armrest brackets
- > Stainless Steel Type 316 roll-back seat hinge with protective shield
- > Roll-back seat bolster allows quick repositioning
- > Custom Vinyl options available for boat builders
- > Ideal for up to 25' boats

Deluxe

- Includes fixed armrests and adjustable bolster

Standard

- Made with fixed seat bottom and available with or without armrests

PRODUCT KNOWLEDGE



All Helm chairs come with durable, Fiberglass seat back.



Deluxe Coastal Helm Chair



Standard Coastal Helm Chair

COLOR GUIDE*



*Due to variations in the printing process, color may vary slightly from the original product. Color sample available upon request.

Part #	Description	"A"	"B"	"C"
Deluxe				
HB10-20AML-0000-0-0	20" Coastal Chair, Amber Leaf	20"	21"	24-1/2"
HB10-20CGR-0000-0-0	20" Coastal Chair, Cool Gray	20"	21"	24-1/2"
HB10-200WH-0000-0-0	20" Coastal Chair, Off White	20"	21"	24-1/2"
HB10-20BKA-0000-0-0	20" Coastal Chair, Black	20"	21"	24-1/2"
Standard				
HB11-19AML-0000-0-0	19" Coastal Chair w/Armrest, Amber Leaf	19"	18-1/2"	24-1/2"
HB11-19CGR-0000-0-0	19" Coastal Chair w/Armrest, Cool Gray	19"	18-1/2"	24-1/2"
HB11-190WH-0000-0-0	19" Coastal Chair w/Armrest, Off White	19"	18-1/2"	24-1/2"
HB11-19BKA-0000-0-0	19" Coastal Chair w/Armrest, Black	19"	18-1/2"	24-1/2"
HB21-19AML-0000-0-0	19" Coastal Chair, Amber Leaf	19"	18-1/2"	24-1/2"
HB21-19CGR-0000-0-0	19" Coastal Chair, Cool Gray	19"	18-1/2"	24-1/2"
HB21-190WH-0000-0-0	19" Coastal Chair, Off White	19"	18-1/2"	24-1/2"
HB21-19BKA-0000-0-0	19" Coastal Chair, Black	19"	18-1/2"	24-1/2"



SEAT PEDESTAL

Seat Pedestal with Slide

Aluminum

- > Available in multiple fixed heights of 8", 12" and 18" to fit most popular applications
- > 3" Aluminum ribbed column for maximum strength
- > Welded column and base to meet H31 seat requirements
- > Cast Aluminum seat support with adjustable position handle
- > Matched low profile seat slide for position adjustments
- > Spring loaded seat support allows easy removal of helm seat from pedestal
- > Custom heights available



Fixed Seat Pedestal with Seat Slide



Part #	Description	Height	Width	Diameter
Z76-1080VEL	Fixed Height Seat Pedestal w/Swivel & Slide	8"	15"	3"
Z76-1120VEL	Fixed Height Seat Pedestal w/Swivel & Slide	12"	15"	3"
Z76-1180VEL	Fixed Height Seat Pedestal w/Swivel & Slide	18"	15"	3"

Please allow 3-4 weeks lead time on all orders



TACO
MARINE

ADJUSTABLE TABLE PEDESTAL



Triton 3-Stage Table Pedestal



Triton 3-Stage column with its single action locking column collars and smooth adjustment is ideal for heavy tables.

Triton 3-Stage

Aluminum

Satin Anodized Finish

- > Adjustable column (4", 3" and 2-3/8") offers added strength and three height positions
- > Gas shock provides smooth operation of column adjustment
- > Stainless Steel polished one-motion clamping mechanism locks in 3 table height positions
- > Keyed column prevents rotation
- > Stowable system
- > Precision engineering with Delrin bearings for smooth trouble-free operation

FULLY ASSEMBLED

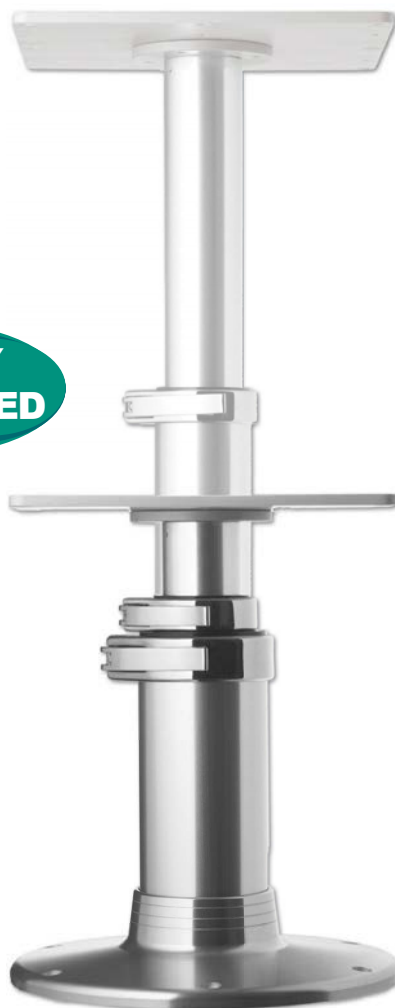

Part #	Range	Top Tube OD	Bottom Tube OD	Finish
Z80-4001VEL-PM	14-1/8" to 28"	2-3/8"	4"	Satin Anodized



ADJUSTABLE TABLE PEDESTAL

Triton 2-Stage

Table Column

Aluminum

- > Power-Matic adjustable height
- > Gas shock provides smooth operation of column adjustment
- > Delrin bearings for smooth operations
- > Available in smooth and ribbed surface
- > Polished, Stainless Steel collars and locking clamps



Adjustable Table Pedestal

PRODUCT KNOWLEDGE

Triton 2-Stage column is tapered at the bottom for secure fit while allowing easy removal and storage. Gas-assisted cylinders assure precise and convenient height adjustments.

Table Support

Aluminum

- > Bow-tie design provides superior table support in a shallow profile for increased leg room

Table Base

Aluminum

- > Fits 3" column size
- > Tapered for secure fit



Smooth Power-Matic Column



Ribbed Power-Matic Column



Part #	Adj. Height	Top Tube OD	Bottom Tube OD	Style	Finish
Column					
Z80-2190VEL32.5-PM	19-1/4" to 32-1/4"	2-3/8"	3"	Ribbed	Satin Anodized
Z80-2600VEL27.75-PM	14-3/8" to 27-3/4"	2-3/8"	3"	Ribbed	Satin Anodized
Z80-2603VEL26-PM	12-5/8" to 26"	2-3/8"	3"	Ribbed	Satin Anodized
Z80-2603VEL26-PMS	12-5/8" to 26"	2-3/8"	3"	Smooth	Satin Anodized



Z20-3160



Z10-4070



Z10-4080

Part #	Description	Length	Width	OD	Finish
Table Support					
Z20-3160PCS60MM	Bow-Tie Design	19-3/4"	7-1/4"	-	Powder Coated Silver
Table Base					
Z10-4070BLY76MM	Surface Mount	-	-	9-7/8"	Brite Anodized
Z10-4080BLY76MM	Flush Mount	-	-	8-5/8"	Brite Anodized



TACO
MARINE



Fixed Height Table Pedestal



Fixed Table Pedestal System is available in both 2-3/8" and 3" OD and is engineered with an Aluminum column and matching table support and table base in standard casting. All columns are tapered on both ends to permit a secure fit while allowing for easy removal and storage.



3-PIECE COMPONENT SYSTEM



Smooth Column



Ribbed Column

Fixed Height Standard 2-3/8"

Fixed Height Deluxe 3"

Table Column

Aluminum

- > Offered in smooth and ribbed finish
- > Dual top and bottom tapered fit

Table Support

Aluminum

- > Designed for fixed height table tops

Table Base

Aluminum

- > Bases are tapered for secure fit
- > Available standard or flush mount

Part #	Length	Style	Finish
Standard - Column OD 2-3/8"			
Z60-7239VEL13-2S	13"	Smooth	Satin Anodized
Z60-7254VEL17.25-2S	17-1/4"	Smooth	Satin Anodized
Z60-7273VEL26.25-2S	26-1/4"	Smooth	Satin Anodized
Z60-7279VEL27.5-2	27-1/2"	Ribbed	Satin Anodized
Z60-7283VEL28.5-2S	28-1/2"	Smooth	Satin Anodized
Z60-7288VEL30.75-2	30-3/4"	Ribbed	Satin Anodized
Z60-8266VEL26-2	26"	Ribbed	Satin Anodized
Deluxe - Column OD 3"			
Z76-7392VEL32-2	32"	Ribbed	Satin Anodized
Z76-9066VEL26-2	26"	Ribbed	Satin Anodized
Z76-9071VEL28-2	28"	Ribbed	Satin Anodized



Z10-4067



Z10-4070



Z10-4080 / Z10-4085 / Z10-4086

Part #	Description	OD	Column	Finish
Table Support				
Z10-4067BLY60MM	Table Support	7"	2-3/8"	Brite Anodized
Z10-4070BLY76MM	Table Support	9-7/8"	3"	Brite Anodized
Table Base				
Z10-4067BLY60MM	Surface Mount	7"	2-3/8"	Brite Anodized
Z10-4070BLY76MM	Surface Mount	9-7/8"	3"	Brite Anodized
Z10-4080BLY76MM	Flush Mount	8-5/8"	3"	Brite Anodized
Z10-4085BLY60MM	Flush Mount	7-1/16"	2-3/8"	Brite Anodized
Z10-4086BLY60MM	Flush Mount (Low Profile)	6-7/8"	2-3/8"	Brite Anodized



STAINLESS STEEL TABLE PEDESTAL

Fixed Height 3"

Table Column

Stainless Steel

- > Custom lengths available upon request

Table Support

Aluminum

- > Designed for fixed table tops and dual taper columns

Table Base

Aluminum & Stainless Steel

- > Bases are tapered for secure fit

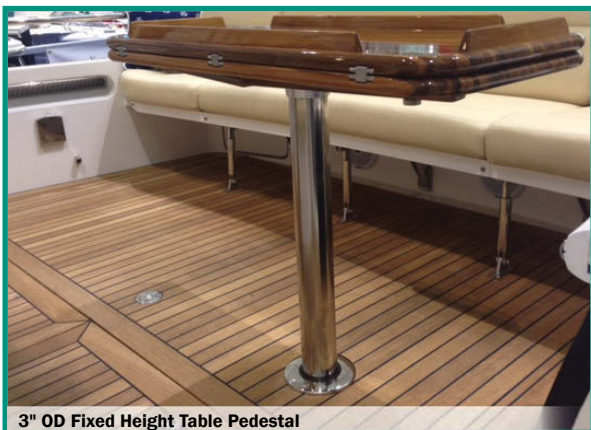

3" OD Fixed Height Table Pedestal

PRODUCT KNOWLEDGE

TM

3" Fixed Table Pedestal System designed to accept a high polished, Stainless Steel tapered column for convenient removal and storage.



**3-PIECE
COMPONENT
SYSTEM**



Smooth Column

Part #	Length	Taper	Style	Finish
Column				
Z76-8000POL28-2	28"	Dual	Smooth	Polished
Z76-8000POL30-2	30"	Dual	Smooth	Polished



Z10-4070



Z10-4097

Part #	Description	OD	Finish
Table Support			
Z10-4070BLY76MM	Surface Mount	9-7/8"	Brite Anodized
Table Base			
Z10-4097POL	Flush Mount	6"	Polished (Stainless Steel Cover Plate)



TACO
MARINE

STAINLESS STEEL SIDE MOUNT TABLE PEDESTAL



Side Mount Pedestal Component System



PRODUCT KNOWLEDGE



Side Mount Table Pedestal System made of Stainless Steel is ideal for limited space in interior and exterior of boat. 125° leg is easy to remove for storage and security.

It allows one pedestal to fit all side mount applications with slightly varying angles eliminating the need for wedges. Utilizing a unique injection molded glass filled nylon adjustable head, the table surface can be tilted to various degrees to provide for a flat horizontal surface. The pedestal is made from Stainless Steel tube welded to a wedge plate that fits securely in a cast Stainless Steel Type 316 mounting bracket.

3-PIECE COMPONENT SYSTEM



F16-0005

Part #	Description	Height	Width	Depth	Finish
F16-0005A	Side Mount Table Pedestal*	17-3/4"	12"	-	Polished S/S Type 304

*1-5/8" tube



F16-0006



F16-0080



F40-0018

Part #	Description	Height	Width	Depth	Color/Finish
Table Support					
F16-0006L	Table Support w/Locking Pin▼	-	-	-	Polished S/S Type 304
Mounting Bracket / Backing Plate					
F16-0080	Mounting Bracket*	4"	4-7/8"	1/2"	Polished S/S Type 316
F40-0018WHC-A	Backing Plate*	4"	2-1/2"	5/32"	Frosty White Delrin

▼1-5/8" tube, 6-1/4" flange *1/4" hole drilled for #10 flat head screw



ACCESSORIES

Universal Leaning Post Backrest

- > Universal design to fit Neptune Premium and Neptune II Leaning Posts and most standard leaning posts
- > Arms install at desired width to fit rod holders
- > Cool, White, easy-to-clean, cushioned backrest
- > Easy storage
- > Hardware included



Universal Leaning Post Backrest

Helm Chair Slide

- > Universal seat slide, perfect match for Taco Marine Capri Helm Chairs and Benches
- > Easy access center handle for convenient operation of slide function
- > Patent pending roller and slide configuration
- > Patent pending double-locking slide actuator
- > Operates up to 500lbs. total weight
- > 3-1/2" of movement
- > Low, 1-3/4" profile



PRODUCT KNOWLEDGE



Universal Leaning Post Backrest has arms that fold for convenient storage.



Part #	Description	Cushion/Arm Height	Cushion Height	Width	Depth
L10-1002-1	Leaning Post Backrest w/Folding Arms	17-1/2"	7-3/8"	34"	3"

PRODUCT KNOWLEDGE



Universal Low Profile Seat Slide is constructed of durable, marine-grade components for long-term use.

Patent #8,556,221



Part #	Description	Fits
M20-0225	Low Profile Universal Helm Chair Seat Slide	Up to 23" Chair
M20-0226	Low Profile Universal Helm Chair Seat Slide	Up to 28" Chair
M20-0227	Low Profile Universal Pedestal Seat Slide	Up to 28" Chair
M20-0228	Low Profile Universal Seat Slide, Bench Style	40" Bench



TACO
MARINE



Neptune Tackle Storage Bag

Neptune Tackle Storage Bag

- > Strong 1000 Denier fabric
- > YKK zippers
- > Center storage space has one of the largest tackle capacities on the market today accommodating 4 full size 3700 Plano boxes, 4 Plano 3600 boxes and 4 smaller Plano boxes
- > Two 9" inner pockets
- > One 29" long tool compartment for tackle gear
- > Includes welt track clips for hanging on leaning post
- > Two double zippered outer pockets ideal for up to five fluorocarbon spools
- > Carbon gray fabric with Black trim and hard shell bottom liner with drain holes and 6 rubber feet



Neptune Tackle Storage Bag is perfect for the traveling angler who destination fishes. Easy to remove from the leaning post allowing the bag to travel with you to and from the boat with comfortable ease.



Leaning Post Cooler Strap Nylon

Flush Mount Base Plug

- > Covers open base holes upon removal of column
- > Prevents water accumulation

Carpet Ring

- > Tapered for clean look
- > Perfect for trimming carpet (1/4" to 1/2" thick) around seat and table columns

Part #	Description	Length	Height	Width	Color
L10-1003BAG	Neptune Tackle Storage Bag	30"	10-1/4"	9-1/2"	Carbon Gray/Black



Part #	Description	Length	Width
L10-1004	Black Nylon Cooler Strap w/Stainless Steel Brackets	38"	2"



Z10-4016



Z10-9998

Part #	Description	Column OD	OD	ID	Color	Material
Z10-4016DEL76MM-A	Flush Mount Base Plug	3"	-	-	-	Delrin
Z10-4026DEL60MM	Flush Mount Base Plug	2-3/8"	-	-	-	Delrin
Z10-9998BKA	Carpet Ring	-	5-3/4"	3-3/4"	Black	Santoprene



SPORT FISHING



**SEATS & PEDESTALS | SPORT FISHING | MARINE FABRICATION | RUB RAIL
TRIM & MOULDING | HINGES & LATCHES | MARINE ACCESSORIES | LED LIGHTING**



Grand Slam 380

Grand Slam 380

Stainless Steel Type 316

- > Accepts 1-1/2" outriggers
- > Versatile design for use on soft tops and hard tops up to 2" thick
- > Rotator handle offset at 30° for added hand clearance
- > Safe outrigger positioning from under the top
- > Heavy-duty grip for sure-handling to lock-in 12 fishing positions
- > Fold-up crank handle for maximum under-top clearance
- > Sealed to prevent water leakage through the mount
- > Outrigger locking pin secures outriggers
- > Polished Stainless Steel arm and brushed anodized Aluminum
- > 4"x6"x1/2" mounting base with easy bolt-down installation included
- > Fits Taco Marine Outrigger-Ready pre-drilled extrusion plates
- > Powder coated finish available by special order
- > Available with increased body length for thicker hard tops up to 4-1/2" (GS-380XL)
- > Ideal for up to 50' boats
- > Sold in Pairs



Patent #7,114,283

GS-380

GS-380XL

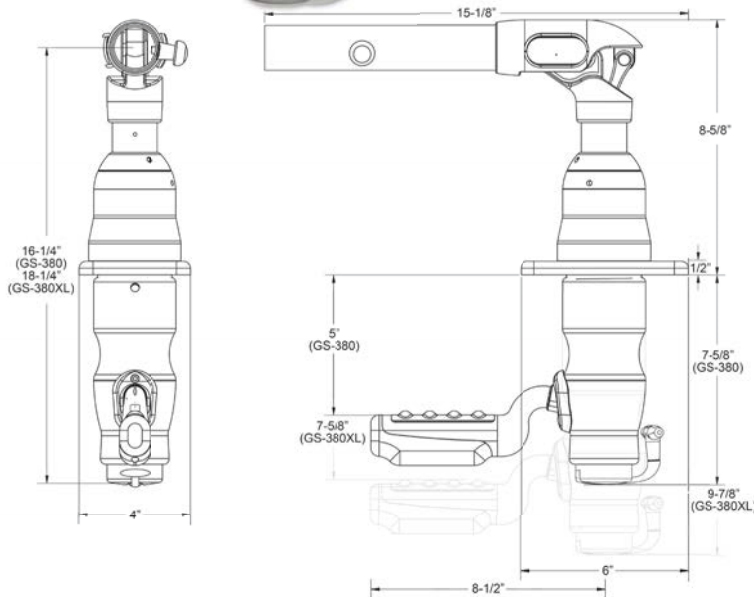

Part #	Description	Length	Width	Depth
GS-380	Grand Slam 380 Top Mount w/30° Offset Handle	16-3/4"	15-1/8"	4"
GS-380XL	Grand Slam 380XL Top Mount w/30° Offset Handle	18-1/4"	15-1/8"	4"



OUTRIGGER MOUNTS

Grand Slam 280

Stainless Steel Type 316

- > Accepts 1-1/2" outriggers
- > Versatile design for use on soft tops and hard tops up to 2" thick
- > Uses Taco Marine Spline Lock Technology for secure outrigger elevation
- > Ergonomic shaped rotator lever
- > Rotator handle adjusts to the desired position
- > Safe outrigger positioning from under the top
- > Secure heavy-duty grip for sure handling in seas
- > Adjustable 12 locking fishing positions
- > Sealed to prevent water leakage
- > 4"x6"x1/2" mounting base with easy bolt-down installation included
- > Fits Taco Marine pre-drilled extrusion plates
- > Available with 30° offset handle (GS-2801)
- > Also available as convenient kit that includes Mounts, Outrigger Poles, Premium Rigging Kit and Line Caddy
- > Ideal for up to 36' boats
- > Sold in Pairs



Grand Slam 280



GS-280

Patent #6,668,745



GS-2801

PRODUCT KNOWLEDGE

Grand Slam 280's Spline Lock Technology is an engineered mechanism that allows multiple adjustment positions and prevents slippage while securing outriggers at the desired height position for increased reliability and performance.

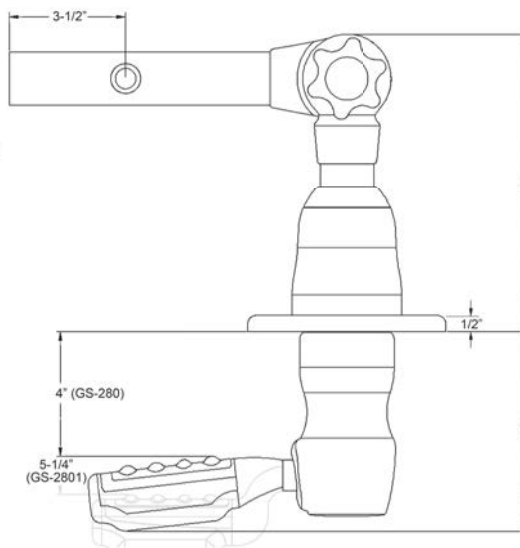
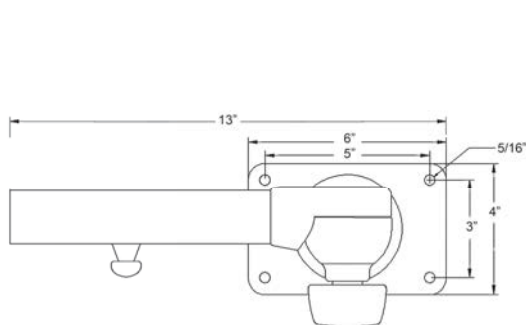

KITS AVAILABLE
Includes Outriggers,
Rigging Kit & Line Caddy
(page SF26)

Part #	Description	Length	Width	Depth
GS-280	Grand Slam 280 Top Mount	15"	13"	4"
GS-2801	Grand Slam 2801 Top Mount w/30° Offset Handle	15"	13"	4"



TACO
MARINE



Grand Slam 170

Grand Slam 170

Stainless Steel Type 316

Designed for use with standard 1-1/8" outriggers

- > Uses Taco Marine Spline Lock Technology for secure outrigger elevation that locks every 18°
- > Delrin bearings and Stainless Steel internal locking mechanism offer smooth adjustments, secure positioning and prevent movement
- > Top mount outrigger positioning
- > Rugged, sure-grip knob adjusts and locks-in desired height and laydown position for safe trailering and navigation under bridges
- > Stainless Steel Type 316 arm with locking feature ensures Taco Marine outriggers remain securely in place
- > 4"x6"x1/2" mounting base with easy bolt-down installation included
- > Also available as convenient kit that includes Mounts, Outrigger Poles, Standard Rigging Kit and Line Caddy
- > Ideal for up to 24' boats
- > Sold in Pairs (GS-170) or as Each (GS-170-2)

Patent #8,186,095



Grand Slam 170's Spline Lock Technology is an engineered mechanism that allows multiple adjustment positions and prevents slippage while securing outriggers at the desired height position for increased reliability and performance.

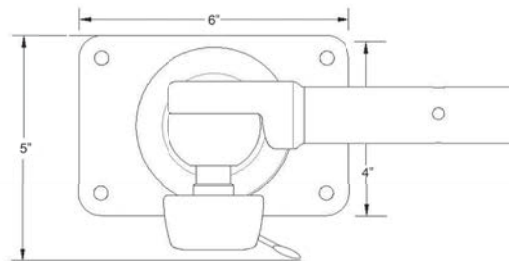
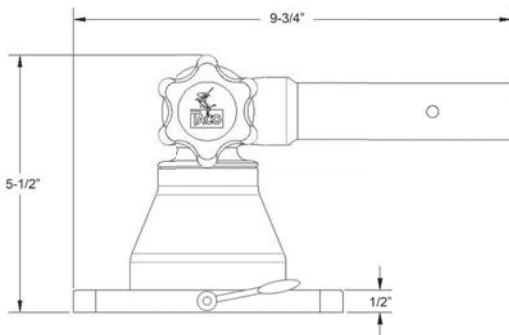

KITS AVAILABLE
Includes Outriggers, Rigging Kit & Line Caddy (page SF26)

Part #	Description	Length	Width	Depth
GS-170	Grand Slam 170 Top Mount	5-1/2"	9-3/4"	4"
GS-170-2	Grand Slam 170-2 Center Top Mount	5-1/2"	9-3/4"	4"



OUTRIGGER MOUNTS

Striker Base Gunnel Mount

Stainless Steel Type 316

Polished Finish

- > Unique hex nut locking design offers multiple fishing positions
- > Ambidextrous 45° arms ideal for trolling from gunnel
- > Designed for use at trolling speed only
- > Removable arms allow for unobstructed gunnel
- > Mounting base included
- > Sold in Pairs

Center Rigger Mount

Stainless Steel Type 316

Polished Finish

- > Clamp-on installation
- > Fits 3/4" and 1" IPS
- > Anti-rotation set screw
- > For use with 8' center rigger poles
- > Also available as a convenient all-in-one kit that includes Mount, Center Rigger Pole and Premium Rigging Kit



Striker Base Gunnel Mount



Center Rigger Mount



F16-0150-F / F16-0212-F

REPLACEMENT PART

M17-1565P-6 & M17-1465P-4



F16-0311C

**KITS
AVAILABLE**
Includes Outriggers,
Rigging Kit & Line Caddy
(page SF26)

Part #	Description	Height	Base	ID
F16-0150-F	Gunnel Mount w/45° Arm	15-1/2"	5-3/4"x3-7/8"x3/8"	1-1/2"
F16-0212-F	Gunnel Mount w/45° Arm	15-1/2"	5-1/8"x 2-5/8"x3/16"	1-1/8"
M17-1465P-4	Replacement 45° Arm for F16-0212-F	15-1/2"	-	1-1/8"
M17-1565P-6	Replacement 45° Arm for F16-0150-F	15-1/2"	-	1-1/2"
F16-0311C-1	Clamp-On Center Rigger Mount	7-1/2"	-	1-1/8"





Grand Slam 890



Grand Slam 890

Grand Slam 890

Aluminum

Light Brushed Anodized Finish

- > Unique design allows for safely raising and lowering antenna or anchor light from under the top
- > Folding crank handle stores flush into base
- > Polished 316 Stainless Steel crank handle
- > Fits standard 1"x14 thread antenna
- > Delrin roller bearings provide for smooth operation and durability
- > Includes 4-1/4"x1/4" round backing plate with easy 1/4"x20 bolt-down installation (hardware not included)
- > Stainless Steel crank assembly
- > Hand crank does not require power

Patent Pending



NEW!
Stainless Steel
crank assembly



Grand Slam 890's folding crank handle stores flush into base.

INCLUDES

Round Backing Plate

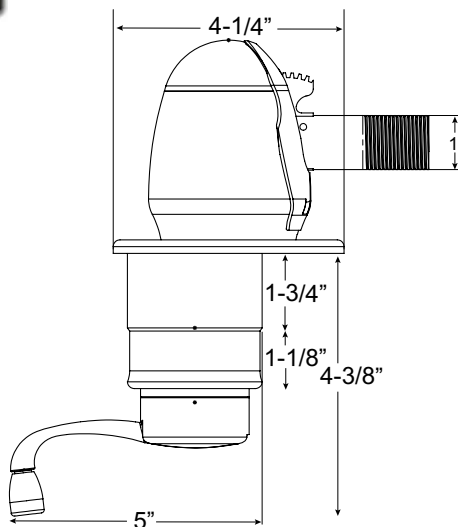

Part #	Description	Height	Width	Hand Crank
GS-890	Grand Slam 890 Universal Mount	9"	5"	2-3/4"



TELE-OUTRIGGER POLES

Tele-Outrigger Pole

Aluminum

Polished Anodized Satin Finish

- > Telescopes to less than 6' for bridge clearance, trailering and storage
- > Designed for universal use with Grand Slams, Striker Bases and other Taco Marine mounts that accept 1-1/2" or 1-1/8" outriggers
- > Also part of convenient kits available for GS-170 and GS-280 Mounts
- > Sold in Pairs

Center Rigger Pole

Aluminum

Polished Anodized Satin Finish

- > Telescopes to less than 5'-1"
- > Designed for universal use with Taco Marine Center Riggers and other mounts that accept 1-1/8" center riggers
- > Also part of convenient kits available for Center Rigger Mount

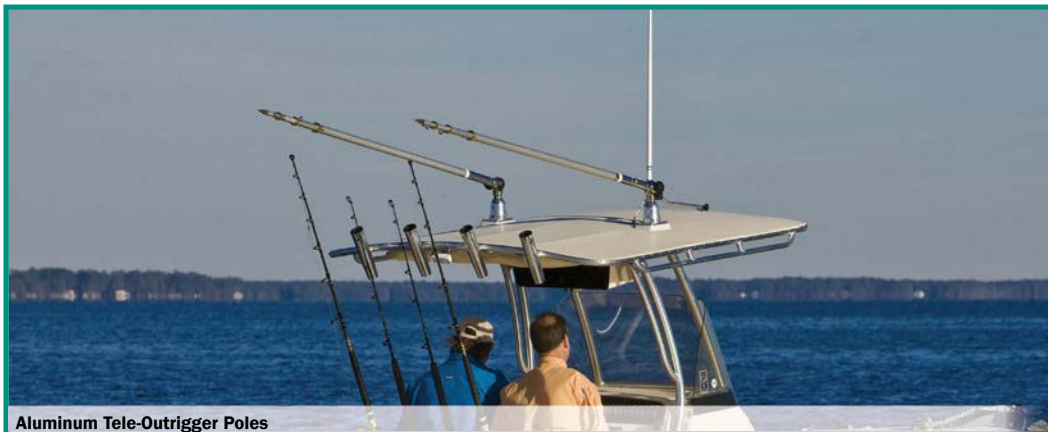

Aluminum Tele-Outrigger Poles



Patent #5,921,196

PRODUCT KNOWLEDGE

TM

Aluminum Tele-Outrigger Poles' precision locking pin is a Stainless Steel V-shaped pin positioned and designed to put out at the full extension of each pole section.

SOLD SEPARATELY

Nylon mesh carry bag (pg SF27)



Outrigger Line Caddy (pg SF37)

KITS AVAILABLE
Includes Mounts, Rigging Kit & Line Caddy (page SF26)

Tele-Outrigger Pole

Center Rigger Pole

Part #	Description	Length	Diameter	Color
OC-0421BKA8	Center Rigger Pole	8'	1-1/8"	Black w/Gold Rings & Tips
OC-0421VEL8	Center Rigger Pole	8'	1-1/8"	Silver w/Gold Rings & Tips
OC-0422BKA8	Center Rigger Pole	8'	1-1/8"	Black w/Silver Rings & Tips
OC-0422VEL8	Center Rigger Pole	8'	1-1/8"	Silver w/Silver Rings & Tips
OC-0432BKA116	Center Rigger Pole	12'	1-1/8"	Black w/Silver Rings & Tips
OC-0432VEL116	Center Rigger Pole	12'	1-1/8"	Silver w/Silver Rings & Tips
OT-0441BKA15	Tele-Outrigger Pole	15'	1-1/8"	Black w/Gold Rings & Tips
OT-0441VEL15	Tele-Outrigger Pole	15'	1-1/8"	Silver w/Gold Rings & Tips
OT-0442BKA15	Tele-Outrigger Pole	15'	1-1/8"	Black w/Silver Rings & Tips
OT-0442VEL15	Tele-Outrigger Pole	15'	1-1/8"	Silver w/Silver Rings & Tips
OT-0541BKA15-HD	Tele-Outrigger Pole	15'	1-1/2"	Black w/Gold Rings & Tips
OT-0541VEL15-HD	Tele-Outrigger Pole	15'	1-1/2"	Silver w/Gold Rings & Tips
OT-0542BKA15-HD	Tele-Outrigger Pole	15'	1-1/2"	Black w/Silver Rings & Tips
OT-0542VEL15-HD	Tele-Outrigger Pole	15'	1-1/2"	Silver w/Silver Rings & Tips
OT-0551BKA186	Tele-Outrigger Pole	18'	1-1/2"	Black w/Gold Rings & Tips
OT-0551VEL186	Tele-Outrigger Pole	18'	1-1/2"	Silver w/Gold Rings & Tips
OT-0552BKA186	Tele-Outrigger Pole	18'	1-1/2"	Black w/Silver Rings & Tips
OT-0552VEL186	Tele-Outrigger Pole	18'	1-1/2"	Silver w/Silver Rings & Tips



TACO
MARINE

TELE-OUTRIGGER POLES

SPORT FISHING



Carbon Fiber Tele-Outrigger Poles

Carbon Fiber Tele-Outrigger Pole

Carbon Fiber

- > Stainless Steel Type 316 collars and double roller allowing double line rigging
- > Adjustable double roller Line Caddies allow for easy rigging to t-top or gunnel
- > Telescopes to less than 7' 6" for bridge clearance, trailering and storage
- > Designed for universal use with Grand Slams, Striker Bases and other Taco Marine mounts that accept 1-1/2" outriggers
- > 16' Carbon Fiber Poles designed with brass rollers for double line rigging; 20' Carbon Fiber Poles designed with brass rollers for triple line rigging
- > Includes a nylon mesh carry bag ideal for preventing damages and scratches as well as a line caddy for storing your lines when poles are retracted
- > Sold in Pairs

Carbon Fiber Center Rigger Pole

Carbon Fiber

- > Telescopes to less than 5'-1"
- > Designed for universal use with Taco Marine Center Rigger mount and other mounts that accept 1-1/8" and 1-1/2" Center Riggers



Carbon Fiber Tele-Outrigger Pole

Carbon Fiber Center Rigger Pole

NEW!

PRODUCT KNOWLEDGE

Carbon Fiber Tele-Outrigger Poles' precision locking pin is a Stainless Steel V-shaped pin

positioned and designed to put out at the full extension of each pole section.



Carbon Fiber Tele-Outrigger Poles' patent pending swivel roller design mechanism allows for movement of the rollers to swivel in the direction of lures or bait for a more natural swimming action which results in hooking more fish.



INCLUDES

Nylon mesh carry bag

Line Caddy for 16' Pole

Line Caddy for 20' Pole

Line Caddy not included in Carbon Fiber Center Rigger Pole

Part #	Description	Length	OD	Color
OT-2120CF	Carbon Fiber Center Rigger Pole	10'	1-1/8"	Black w/Silver Rings & Tips
OT-2160CF-2	Carbon Fiber Center Rigger Pole	16'	1-1/2"	Black w/Silver Rings & Tips
OT-3160CF	Carbon Fiber Outrigger Pole	16'	1-1/2"	Black w/Silver Rings & Tips
OT-4200CF	Carbon Fiber Outrigger Pole	20'	1-1/2"	Black w/Silver Rings & Tips



TACO MARINE

OUTRIGGER KITS

Grand Slam 170 Kit

- > Kit includes 2-GS-170 Mounts, Tele-Outrigger Poles, Standard Rigging Kit and Line Caddy

Grand Slam 280 Kit

- > Kit includes 2-GS-280 Mounts, Tele-Outrigger Poles, Premium Rigging Kit and Line Caddy

Center Rigger Mount Kit

- > Kit includes 1-Center Rigger Mount, Center Rigger Pole and Center Rigging Kit

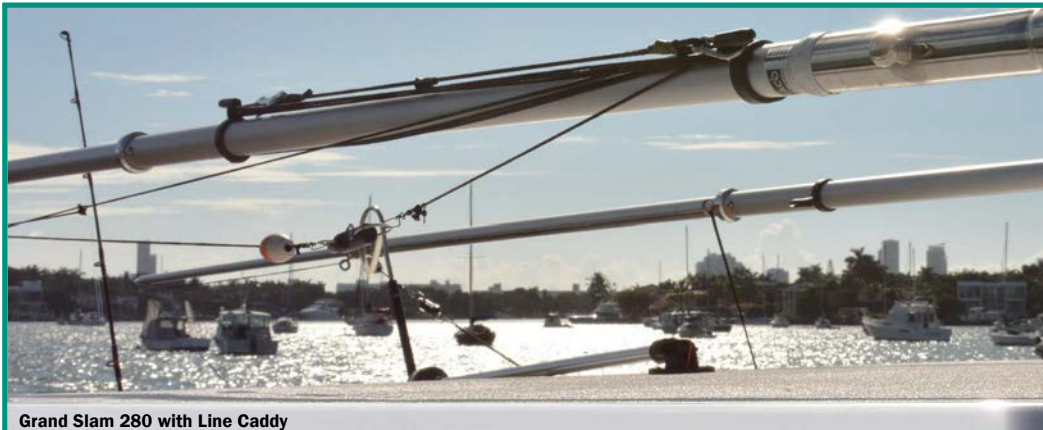

Grand Slam 280 with Line Caddy



GS-170 Mounts



Tele-Outriggers



Standard Rigging Kit

Line Caddy



GS-280 Mounts



Tele-Outriggers



Premium Rigging Kit

Line Caddy



Center Rigger Mount



Center Rigger



Center Rigging Kit

Part

Description

GS-170BKA15-1	1-1/8" Diameter, 15' Outriggers in Black w/Gold Rings, Line Caddy, Standard Rigging Kit
GS-170VEL15-1	1-1/8" Diameter, 15' Outriggers in Silver w/Gold Rings, Line Caddy, Standard Rigging Kit
GS-2841BKA-1	1-1/2" Diameter, 15' Outriggers in Black w/Gold Rings, Line Caddy, Premium Rigging Kit
GS-2841VEL-1	1-1/2" Diameter, 15' Outriggers in Silver w/Gold Rings, Line Caddy, Premium Rigging Kit
GS-2842VEL-1	1-1/2" Diameter, 15' Outriggers in Silver w/Silver Rings, Line Caddy, Premium Rigging Kit
F16-0311BKA8SB	1-1/8" Diameter, 8' Outrigger in Black w/Gold Rings, Center Rigging Kit
F16-0311VEL8SB	1-1/8" Diameter, 8' Outrigger in Silver w/Gold Rings, Center Rigging Kit



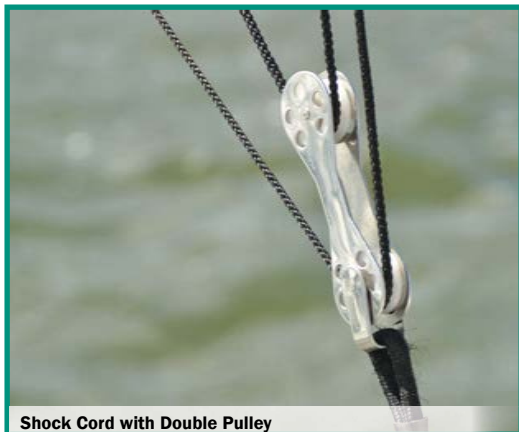

Shock Cord with Double Pulley



Outrigger Release Clip

Rigging Kit Components

- > Complete selection of replacement parts
- > Available for upgrading and/or repairing outrigger rigging kits
- > Sold in Pairs



COK-0001B-2



COK-0001T-2



COK-0008B-1



F40-0030BKA-1



COK-0017-2 / COK-0018-2



COK-0004G-2



F16-1200-2



COK-0024



COK-0020-2



COK-0021-2



COK-0022-2



COK-0043-1

Part #

- COK-0001B-2**
- COK-0001T-2**
- COK-0004G-2**
- COK-0008B-1***
- COK-0017-2**
- COK-0018-2**
- COK-0020-2**
- COK-0021-2**
- COK-0022-2**
- COK-0024***
- COK-0043-1***
- F16-1200-2***
- F40-0030BKA-1**

Description

- Standard Zip Outrigger Release Clip
- Premium Outrigger Release Clip
- Outrigger Glass Rings
- Black Dacron 1/8" Line, 100'
- Outrigger Line Ball Stops, 1-1/4"
- Outrigger Line Ball Stops, 1-3/4"
- Shock Cord w/Single Pulley, 12"
- Glass Eye w/Shock Cord, 12"
- Shock Cord w/Double Pulley, 12"
- Outrigger Carry Bag, Black, 74" x 12"
- Triple Roller w/Shock Cord Pulley, 16"
- Stainless Steel Eye Straps
- Outrigger Line Caddy for 1-1/8" & 1-1/2" Poles

* Sold in Bulk Only *Sold as Each *Sold in 4's



RIGGING KITS

Premium Single Rigging Kit / Premium Double Rigging Kit

- > Available as single or double Rigging Kit
- > Rigs up to 22' outriggers
- > Also part of convenient kits available for GS-280 Mount

Standard Single Rigging Kit

- > Rigs up to 22' outriggers
- > Also part of convenient kits available for GS-170 Mount

Premium Center Rigging Kit

- > Rigs up to 25' center rigger
- > Also part of convenient kits available for Center Rigger Mount

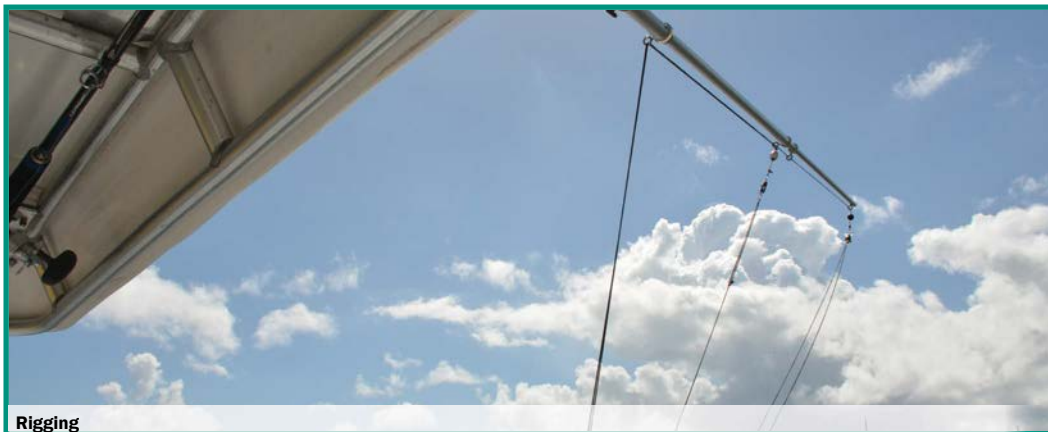

Rigging



Premium Single Rigging Kit

- > Single Roller Pulley Shock Cord w/Stainless Steel Snap Hook and Eye Insert;
- > 1/8" thick, 100' Dacron Rigging Cord in Black
- > Adjustable Tension Release Clip
- > 1-1/4" Outrigger Line Stops
- > Pad Eye with Screws
- > Double Sleeve Crimp
- > Swivel
- > Snap Swivel
- > Quick Dry Mesh Bag



Premium Double Rigging Kit

- > Double Roller Pulley Shock Cord w/Stainless Steel Snap Hook and Eye Insert;
- > 1/8" thick, 200' Dacron Rigging Cord in Black
- > Adjustable Tension Release Clip
- > 1-3/4" Outrigger Line Stops
- > Pad Eye with Screws
- > Double Sleeve Crimp
- > Swivel
- > Snap Swivel
- > Quick Dry Mesh Bag



Standard Single Rigging Kit

- > Glass Ring Shock Cord w/Brass Snap Clip
- > 1/8" thick, 100' Dacron Rigging Cord in Black
- > Adjustable Tension Release Clip
- > 1-1/4" Outrigger Line Stops
- > Pad Eye & Pad Eye Screws
- > Double Sleeve Crimp
- > Swivel
- > Snap Swivel
- > Quick Dry Mesh Bag



Premium Center Rigging Kit

- > Single Roller Pulley Shock Cord w/Stainless Steel Snap Hook and Eye Insert
- > 1/8" thick, 50' Dacron Rigging Cord in Black
- > Adjustable Tension Release Clip
- > 1-1/4" Outrigger Line Stop
- > Pad Eye & Pad Eye Screws
- > Double Sleeve Crimp
- > Swivel
- > Snap Swivel
- > Quick Dry Mesh Bag

Part #	Description
RK-0001PB	Premium Single Rigging Kit
RK-0002PB	Premium Double Rigging Kit
RK-0001SB	Standard Single Rigging Kit
RK-0001PCB	Premium Center Rigging Kit





Cork Outrigger Line Stops

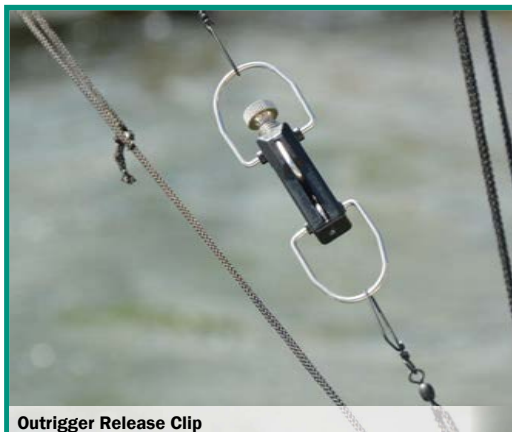

Outrigger Release Clip

Premium Mono Double Rigging Kit / Premium Mono Triple Rigging Kit

- > Available as double or triple Rigging Kit
- > Used on Carbon Fiber Outrigger Poles 20' or larger

Premium Braid Triple Rigging Kit

- > Used on Carbon Fiber Outrigger Poles
- > Ideal for Aluminum or Carbon Fiber Outrigger Poles 18' or larger



NEW!

Premium Mono Double Rigging Kit

- > Double Roller Pulley Shock Cord w/Stainless Steel Snap Hook
- > 1/8" thick, 600' coil of Lindgren Pitman 400# Monofilament in Black
- > Adjustable Tension Release Clips
- > 1-3/4" Outrigger Line Stops
- > Stainless Steel Eye Strap and Screws
- > Double Sleeve Crimps
- > Coastlock-style Swivels and Snap Swivels
- > Quick Dry Mesh Bag



NEW!

Premium Mono Triple Rigging Kit

- > Ronstan Triple Roller Pulley Shock Cord w/Stainless Steel Snap Hook
- > 1/8" thick, 600' coil of Lindgren Pitman 400# Monofilament in Black
- > Adjustable Tension Release Clips
- > 1-3/4" Outrigger Line Stops
- > Stainless Steel Eye Strap and Screws
- > Double Sleeve Crimps
- > Coastlock-style Swivels and Snap Swivels
- > Quick Dry Mesh Bag



NEW!

Premium Braid Triple Rigging Kit

- > Ronstan Triple Roller Pulley Shock Cord w/Stainless Steel Snap Hook
- > 1/8" thick, 300' Dacron Rigging Cord in Black
- > Adjustable Tension Release Clips
- > 1-3/4" Outrigger Line Stops
- > Stainless Steel Eye Strap and Screws
- > Double Sleeve Crimps
- > Coastlock-style Swivels and Snap Swivels
- > Quick Dry Mesh Bag

Part #	Description
RK-0002MP	Premium Mono Double Rigging Kit
RK-0003MP	Premium Mono Triple Rigging Kit
RK-0003PB	Premium Braid Triple Rigging Kit



ROD HOLDERS

Clamp-On Adjustable Rod Holder

Stainless Steel Type 316 Polished Finish

- > Stainless Steel Rod Holders include inserts that allow adjustment of clamp to fit multiple pipe/tube sizes
- > For use on vertical and horizontal pipe/tube
- > Rotates and locks every 18°



Clamp-On Adjustable Rod Holder



Stand-Off Rod Holder

Plastic

- > Rod Holder includes insert that allows adjustment of clamp to fit 7/8" & 1" tube sizes
- > For use on vertical and horizontal tube
- > Rotates and locks every 18°

Surface Mount Rod Holder

High-Density Polyethylene

Stand-Off Rod Holder

- Front access hole and integrated stand-off for easy mounting
- Available in both Black and White

Thru-Bolt Rod Holder

- Pre-drilled, front access holes
- Available in both Black and White

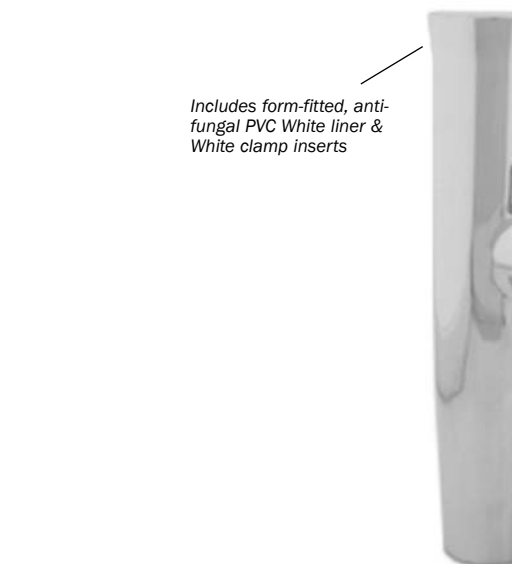

F16-2623

Includes form-fitted, anti-fungal PVC White liner & White clamp inserts

Patent Pending



Clamp-On Adjustable Rod Holders rotate and lock every 18°. Ideal for bow rail, grab rail, t-top, leaning post, poling platform..



F41-2700

Includes Black clamp insert



P04-091 / P04-0111



P04-011

Part #	Description	Rod Holder ID	Color/Finish
F16-2600POL-1	Clamp Fits 7/8" & 1" OD	1-5/8"	Polished
F16-2623POL-1	Clamp Fits 1-1/16" & 1-5/16" OD (Pipe), 1-1/4" OD	1-5/8"	Polished
F16-2630POL-1	Clamp Fits 1-11/16" & 1-15/16" OD	1-5/8"	Polished
F41-2700WHA-1	Clamp Fits 7/8" & 1" OD	1-3/4"	White
P04-091B	Poly Stand-Off Rod Holder	1-3/4"	Black
P04-091W	Poly Stand-Off Rod Holder	1-3/4"	White
P04-0111W	Poly Stand-Off Rod Holder w/Stainless Steel Hardware	1-3/4"	White
P04-011BX	Poly Thru-Bolt Rod Holder w/Mounting Holes	1-3/4"	Super Black
P04-011W	Poly Thru-Bolt Rod Holder w/Mounting Holes	1-3/4"	White

Stainless Steel Plastic / Polyethylene



TACO
MARINE



Trident 3-Rod Cluster-Straight



Trident Eye Strap



Trident 3-Rod Cluster-Offset

Trident 3-Rod Cluster

Aluminum

Polished Anodized Finish

- > Includes detachable tool caddy
- > Solid gimbal design for secure locking placement
- > Includes eye strap for securing rods and reels
- > Includes form-fitted anti-fungal PVC White liner

Straight

- Straight gunnel mount 3-rod holder

Offset

- Offset gunnel mount 3-rod holder

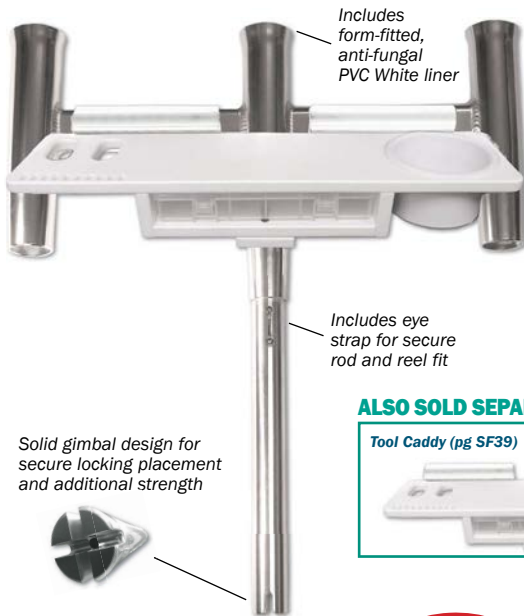

F31-0780

NEW!

ALSO SOLD SEPARATELY

Tool Caddy (pg SF39)

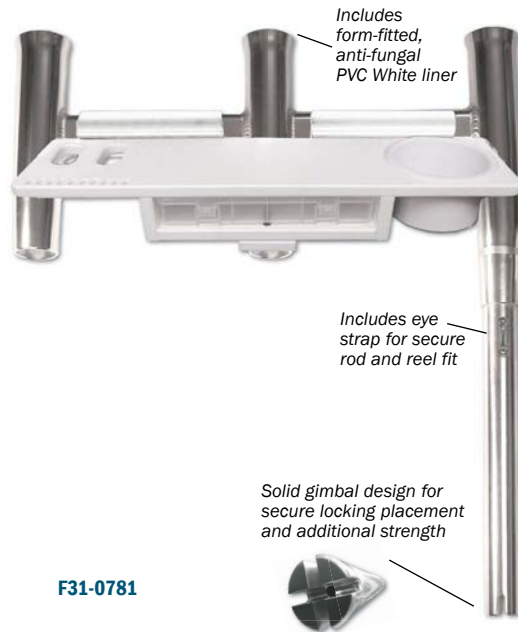

F31-0781

NEW!

Part #	Description	Height	Width	Rod Holder ID	Rod Holder Height
F31-0780BXY-1	Trident 3-Rod Cluster Straight	24-7/8"	22-3/8"	1-3/4"	9-3/4"
F31-0781BXY-1	Trident 3-Rod Cluster Offset	24-7/8"	22-3/8"	1-3/4"	9-3/4"



ROD HOLDERS

Kite Fishing Rod Cluster

Aluminum

Brushed Anodized Finish

- > Gunnel mount 3-rod holder
- > 15° bent shaft for clearance
- > Fits all standard gunnel mount rod holders

Olympic 5-Rod Cluster

Aluminum

Polished Anodized Finish

- > Gunnel mount 5-rod holder
- > Ideal for both spinning and conventional rods and reels
- > Designed with shorter blades for tight grouping
- > Longer, 9-3/4" Rod Holders to secure Big Game Tackle
- > Holes on blades to secure each rod and reel separately
- > Convenient rigging and wash down station for start and end of fishing day
- > Solid gimbal design for secure locking placement and additional strength
- > Ergonomic grip handle



Kite Fishing Rod Cluster



Olympic 5-Rod Cluster

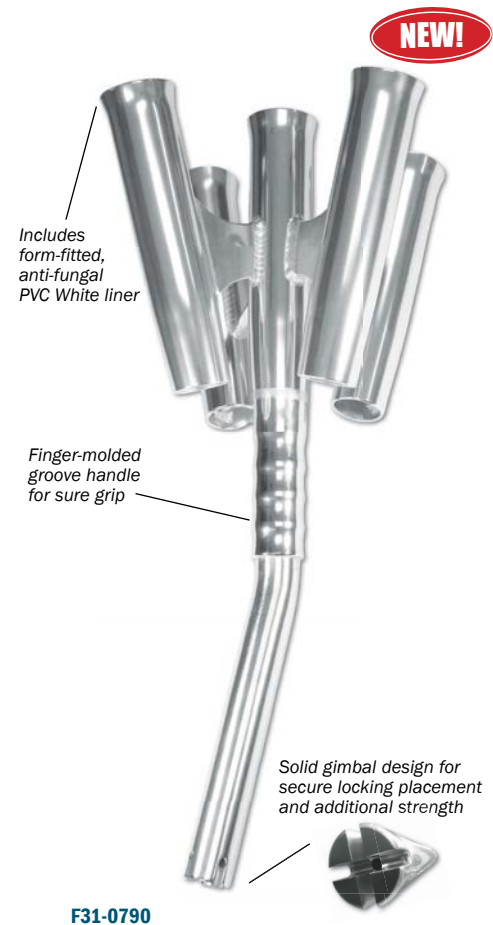
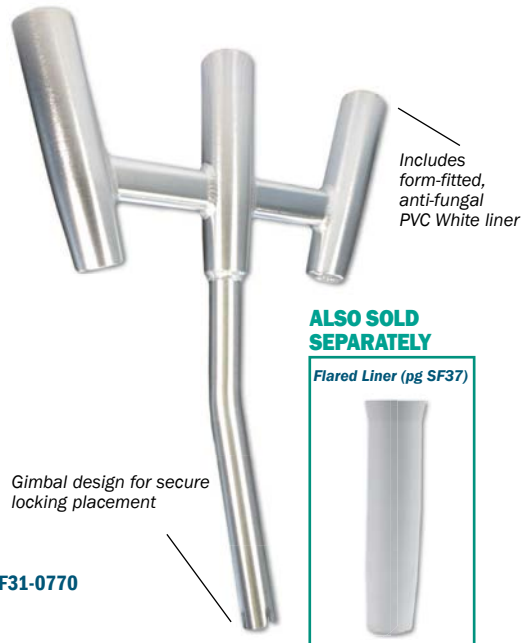

Part #	Description	Height	Width	Rod Holder ID	Rod Holder Height
F31-0770BSA-1	Kite Fishing Rod Cluster	24-1/2"	20"	1-3/4"	9-3/4"
F31-0790BXY-1	Olympic 5-Rod Cluster	26"	13-1/2"	1-3/4"	9-3/4"





Deluxe Pontoon Boat Tackle Rack



Rod & Reel Tote'm Rack

Deluxe Pontoon Boat Tackle Rack

High-Density Polyethylene

- > Compact design is big enough to hold spinning and conventional tackle
- > Stainless Steel fasteners resist rust and corrosion
- > Secure and convenient on-board rod storage

Rod & Reel Tote'm Rack

High-Density Polyethylene

- > Holds four conventional rods and reels
- > Easy and lightweight
- > Mounts vertical or horizontal using supplied mounting bracket with secure pin

"Bungee" Rod Holder

High-Density Polyethylene

- > Perfect for under the gunnel
- > Bungee cords keep your rods safe and secure
- > Includes 2-1/2" mounting backing plates and hardware



Rods and reels not included

P03-074W

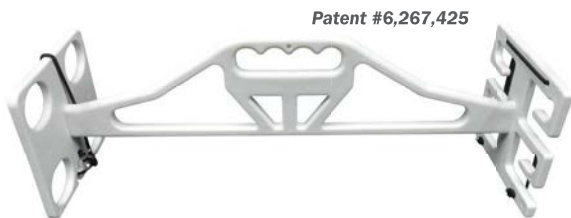

Patent #6,267,425

P03-144W

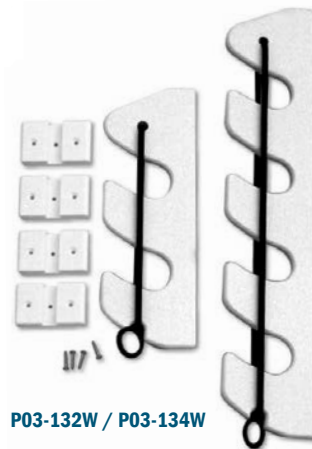

P03-132W / P03-134W

Part #	Description	Height	Width	Depth	Thick	Color
P03-073W	3-Rod Deluxe Pontoon Tackle Rack	-	17-1/2"	4"	1/2"	White
P03-074W	4-Rod Deluxe Pontoon Tackle Rack	-	23-1/4"	4"	1/2"	White
P03-144W	Rod & Reel Tote'm Rack	-	18-5/8"	7-1/2"	1/2"	White
P03-132W	2-Rod "Bungee" Rod Holder	3-3/4"	9-1/4"	-	1/2"	White
P03-133W	3-Rod "Bungee" Rod Holder	3-3/4"	12-1/2"	-	1/2"	White
P03-134W	4-Rod "Bungee" Rod Holder	3-3/4"	15-5/8"	-	1/2"	White
P03-134S	4-Rod "Bungee" Rod Holder	3-3/4"	15-5/8"	-	1/2"	Sea Foam



ROD STORAGE

Rod Rack

**Aluminum w/Poly
Brite Dipped Sanded
Anodized Finish**

- > Recessed fasteners
- > Designed for spinning reels
- > Features convenient integrated slots for knife and pliers
- > Available in 3- & 4-rod storage sizes

Deluxe Rod Rack

High-Density Polyethylene

- > Durable Polyethylene to withstand the harsh marine environment
- > Rod Holder ID 1-3/4"
- > Flared Rod Holder for easy rod handling
- > Slotted Rod Holders lock-in most conventional and spinning outfits
- > Features convenient integrated slots for knife and pliers
- > Available in 2-, 3- & 4-rod storage sizes



Aluminum Rod Rack



F31-3103



Knives and pliers not included

P03-063W

Part #	Description	Height	Width	Rod Holder ID
F31-3103BXZ	3-Rod Holder Rack, Aluminum w/Poly	8-1/2"	13-3/8"	1-1/2"
F31-3104BXZ	4-Rod Holder Rack, Aluminum w/Poly	8-1/2"	18"	1-1/2"
P03-062W	2-Rod Poly Rod Rack	12"	11-1/2" / RH to RH 6-1/2"	1-3/4"
P03-063B	3-Rod Poly Rod Rack	12"	18" / RH to RH 6-1/2"	1-3/4"
P03-063W	3-Rod Poly Rod Rack	12"	18" / RH to RH 6-1/2"	1-3/4"
P03-064B	4-Rod Poly Rod Rack	12"	18" / RH to RH 4-1/2"	1-3/4"
P03-064W	4-Rod Poly Rod Rack	12"	18" / RH to RH 4-1/2"	1-3/4"





Aluminum Rod Rack



Transom Mount Rod Rack

Rod Rack

Aluminum

- > Concealed fasteners
- > Available in 3- & 4-rod storage sizes

Transom Mount Rod Rack

Aluminum

Brushed Anodized Finish

- > Spine adjusts for rod holder angle and rack to fit the contour of the transom
- > Available in 3- & 4-rod storage sizes



Includes form-fitted, anti-fungal PVC Black liner

F31-3004



Includes form-fitted, anti-fungal PVC White liner

F31-3503



Transom Mount Rod Rack's angle is easy to adjust.

Part #	Retail #	Description	Height	Width	Rod Holder ID
F31-3003BSA	F31-3003BSA-1	3-Rod Holder Rack	8-1/2"	11-1/4"	1-1/2"
F31-3004BSA	F31-3004BSA-1	4-Rod Holder Rack	8-1/2"	16"	1-1/2"
F31-3503BSA	F31-3503BSA-1	3-Rod Transom Mount Rod Rack	10"	34"	1-7/8"
F31-3504BSA	F31-3504BSA-1	4-Rod Transom Mount Rod Rack	10"	40-1/2"	1-7/8"



ROD STORAGE

Rod Hanger

Stainless Steel Type 316

High Polished

- > Spring locking rod tip holder
- > Delrin inserts
- > Concealed installation screws
- > Also available as a kit that includes revolving rod tip holder and stationary rod hanger

Rod Hanger Rack

Stainless Steel Type 316

High Polished

- > Durable, UV-stabilized White poly racks
- > Three sizes for convenient 2-, 3- & 4-rod storage
- > Pre-drilled mounting holes and beveled edges
- > Mount vertically, horizontally and overhead
- > Sold in Pairs

Reel Hanger

Stainless Steel Type 316

- > Corrosion-resistant, Stainless Steel spring secures reel into position
- > Adjustable to fit most popular trolling reels
- > Also available as a kit that includes reel hanger with rod tip holder



Rod Hanger Racks

Patent #7,228,655



F19-0006-1



F19-0006-2



F16-2700 Kit

PRODUCT KNOWLEDGE
IM

Rod Hangers use precision, spring-loaded locking pin.

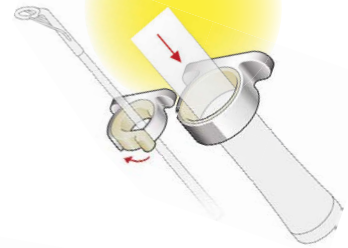

F16-2752

PRODUCT KNOWLEDGE
IM

Reel Hangers are adjustable from 1-7/8" to 3-7/8" to fit most popular trolling reels.



F16-2810

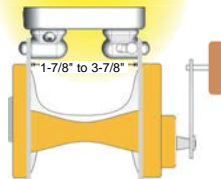

F16-2810 Kit

Part #	Description	Length	Width
F19-0006-1	Revolving Rod Tip Holder	2-3/8"	1"
F19-0006-2	Stationary Rod Hanger	2-3/4"	1"
F16-2700-1*	Revolving Rod Tip Holder & Stationary Rod Hanger Kit	-	1"
F16-2751-1	2-Rod Hanger w/Poly Rack	9-1/8"	1-1/2"
F16-2752-1	4-Rod Hanger w/Poly Rack	18"	1-1/2"
F16-2753-1	3-Rod Hanger w/Poly Rack	13-1/2"	1-1/2"
F16-2810	Reel Hanger	3-7/8"	1"
F16-2810-1*	Reel Hanger w/Rod Tip Holder Kit	-	1"

*Clam shell retail pack



TACO
MARINE



Outrigger Line Caddy

Mounting Plate

Aluminum

320 Grit Brite Anodized

- > Ideal for all mounts that require additional support on hard tops and gunnels
- > Backing plate offers additional strength and support from under the top
- > Wedge plate injection molded plastic wedges for use with curved t-tops
- > Sold in Pairs

Base Reducer

Aluminum & Nylon

- > Reduces ID from 1-1/2" to 1-1/8" to accept 1-1/8" diameter outriggers
- > Nylon outer sleeve fits 1-1/2" tube
- > Sold in Pairs

Rod Holder Liner

PVC

- > Extruded, tapered PVC
- > Available for both straight and flared rod holders
- > Press fit into rod holders

Outrigger Line Caddy

Nylon

- > Clamps to outriggers to eliminate tangling and maintain rigging when outriggers are retracted
- > Rugged, long lasting nylon
- > Sold in Pairs

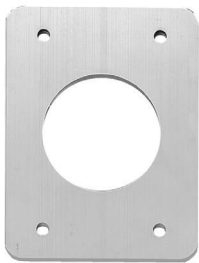

BP-150



WP-150



GSC-0025



F31-0700



F31-2201



F40-0030

Part #	Description	ID	OD	Height	Width	Depth
BP-150BSY-320-1	Backing Plate	-	-	3-1/2"	18-1/2"	7"
WP-150WHA-1	Wedge Plate, 7.5°	-	-	1/2"	32"	12"
F31-0700LW	Straight Liner fits F31-0700 Rod Holder	1-1/2"	1-3/4"	7"	-	-
F31-2201WHA-C	Flared Liner fits F31-2200 Rod Holder	1-3/4"	2"	7"	-	-
F31-2301WHA	Flared Liner fits F31-2300 Rod Holder	2"	2-1/4"	7"	-	-
GSC-0025-1	Base Reducer	1-1/8"	1-1/2"	6"	-	-
F40-0030BKA-1	Outrigger Line Caddy	1-1/8" & 1-1/2"	1-3/4"	2-7/8"	1-3/4"	1-1/2"



ACCESSORIES

Tumbler Holder

High-Density Polyethylene

- > Thick, 3/8" Starboard Polymer
- > Holds tumbler at proper height to prevent tipping
- > Single holder holds 16 to 30 oz. tumbler; double holder holds 2-16 to 30 oz. tumblers
- > Includes mobile device cutout and charging cable port
- > Drain holes on recessed bottom areas
- > Available in either Black or White Polymer
- > Includes large suction cups
- > Can be fix mounted

Drink Holder

High-Density Polyethylene

- > Holds full-sized insulated drink and mugs
- > Includes Stainless Steel mounting screws for flat or bulkhead mount
- > Includes suction cups
- > Convenient drink storage



Tumbler Holders



Patent Pending

NEW!

Tumbler & phone
not included

P01-2010



NEW!

Tumblers & phone
not included

P01-2020



P01-2000



P01-2001



P01-2003

Part #	Description	Height	Width	Depth
P01-2010B	1-Tumbler Poly Holder, Black	5-5/8"	4-7/8"	5-1/4"
P01-2020B	2-Tumbler Poly Holder, Black	5-3/8"	9-1/2"	5-5/8"
P01-2010W	1-Tumbler Poly Holder, White	5-5/8"	4-7/8"	5-1/4"
P01-2020W	2-Tumbler Poly Holder, White	5-3/8"	9-1/2"	5-5/8"
P01-2000W	2-Drink Poly Holder "Catch-All"	5-1/4"	16-1/4"	3-1/4"
P01-2001W	2-Drink Poly Holder	3-1/2"	9-3/4"	4-3/4"
P01-2003W	1-Drink Poly Holder	4-5/8"	4-5/8"	3-1/2"



TACO
MARINE



Poly Filet Table with Adjustable Gunnel Mount

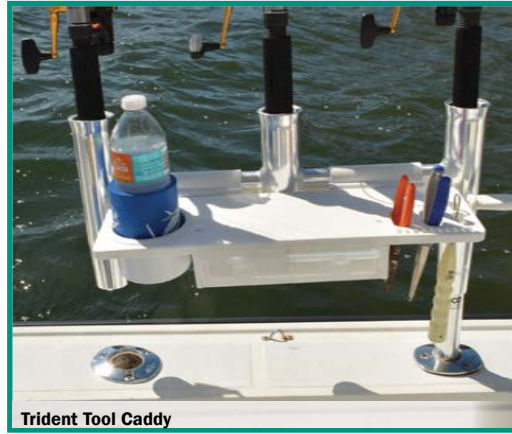

Trident Tool Caddy

Trident Tool Caddy

High-Density Polyethylene

- > UV-stabilized, high-density White Polymer
- > Designed to fit on Trident Straight and Offset Rod Holders
- > Adjustable angle
- > Includes cup holder
- > Holds up to 10 rigs
- > Hidden filet knife holder
- > Includes Plano tackle tray
- > Fits on standard oval pipe

Poly Filet Table with Adjustable Gunnel Mount

High-Density Polyethylene

- > Adjustable tilt
- > FDA-approved table
- > Includes Stainless Steel fasteners
- > Slotted for knife, plier holder and drainage
- > Rugged engineered Nylon tilt mount
- > Folds flat for storage
- > Fits into any 15° and 30° Rod Holder
- > The mount locks at any angle



P01-2120

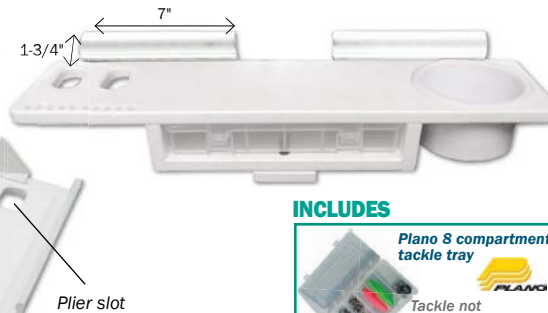

P01-3000

INCLUDES



P01-1000



P01-1001



P01-1200

Fishing Knife & Plier Holder

High-Density Polyethylene

- > Safe and convenient storage
- > Includes Stainless Steel mounting screws

Rigging Strip

- > Stores pre-rigs, plugs and spoons
- > Used on any flat surface
- > Pre-drilled holes
- > Offered with marine-grade self-adhesive tape

Part #	Description	Height	Width	Depth
P01-2120W	Adjustable Poly Filet Table, 20"	2"	20"	12"
P01-2132W	Adjustable Poly Filet Table, 32"	2"	32"	12"
P01-3000W	Trident Tool Caddy	3-1/2"	18-1/2"	7"
P01-1000W	Knife & Plier Holder	7-1/2"	6-1/2"	1/2"
P01-1001W	Knife, Plier & 15-Rig Holder	8-3/4"	4"	2-1/4"
P01-1200W	Adhesive Mount Rigging Strip	1-1/4"	12-1/2"	1/2"





MARINE FABRICATION



**SEATS & PEDESTALS | SPORT FISHING | MARINE FABRICATION | RUB RAIL
TRIM & MOULDING | HINGES & LATCHES | MARINE ACCESSORIES | LED LIGHTING**

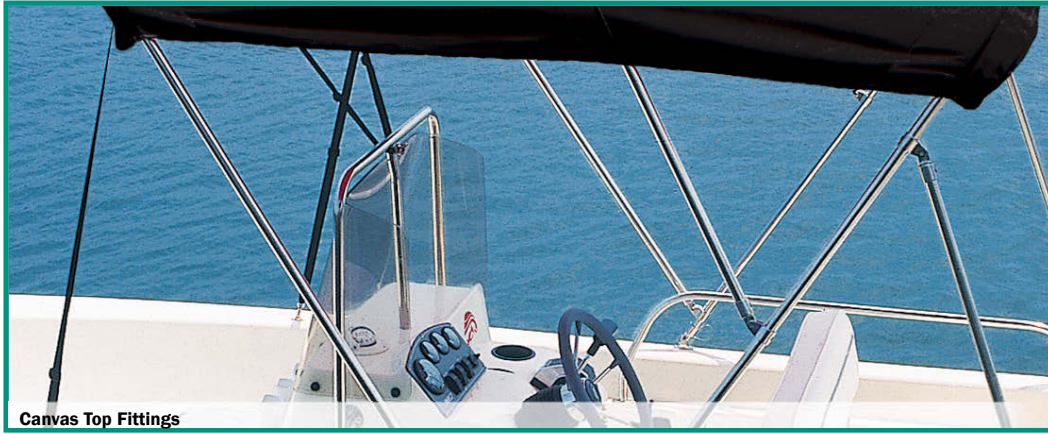

Ball & Socket Top Cap

**Stainless Steel Type 316
Polished Finish**

- > Patented ball and socket pivot design offers full range of motion
- > Delrin insert provides tight, quiet, rattle-free fit and smooth operation
- > Quick release pull and D-ring pin
- > Easy installation

Patent #D437,210 #D451,364 #D451,371



F11-0171



F11-0180



F11-0182



F11-1001



F12-0190 / F12-0191



Ball and Socket pivot design for full range of motion with anti-rattle Delrin insert.

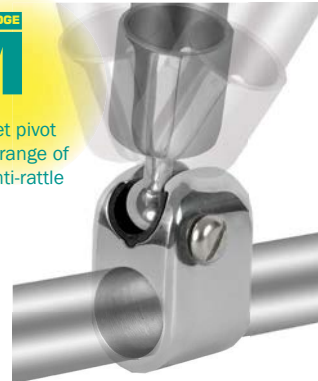

Part #	Description	Tube	Fastener
F11-0171A	Inside Eye End	7/8"	Crimped
F11-0177A	Top Cap	7/8"	Pop Rivet
F11-0177S	Top Cap	7/8"	Set Screw
F11-0180P	90° Top Cap for Portside (Side Mount)	7/8"	Pop Rivet
F11-0180S	90° Top Cap (Side Mount)	7/8"	Set Screw
F11-0180SB	90° Top Cap for Starboard (Side Mount)	7/8"	Pop Rivet
F11-0182	Top Cap	3/4"	Pop Rivet
F11-1001AS	Jaw Slide "Deluxe"	7/8"	Set Screw
F11-1001	Jaw Slide "Deluxe"	7/8"	Pop Rivet
F12-0181S	Top Cap	1"	Set Screw
F12-0182	Inside Eye End	1"	Crimped
F12-0190	Square Inside Eye End	1-1/4"*	Pop Rivet
F12-0191	Square Inside Eye End	1-1/4"**	Pop Rivet
F12-0300S	Jaw Slide "Deluxe"	1"	Set Screw

*Wall tube .065" **Wall tube .095"



CANVAS TOP FITTINGS

Deck Hinge

Stainless Steel Type 316

Polished Finish

- > Offered in concave and flat mounts
- > All Deck Hinges compatible with 3/4", 7/8", 1" and 1-1/4" tube
- > Fits standard tube sizes and windshield headers
- > Secure fit

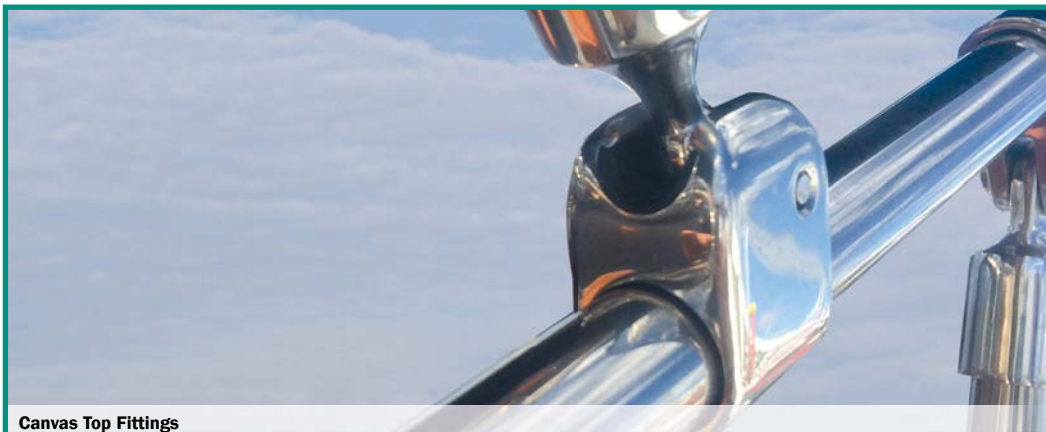

Canvas Top Fittings



F13-0241



F13-0242



F13-0301



F13-0302



F13-1085



F13-1095



F13-0244

PRODUCT KNOWLEDGE
TM

F13-1095 Concave Deck Hinge fits windshield header.



Part #	Description	Tube
F13-0241/244BN	Flat Deck Hinge w/Pin & Lanyard	7/8"
F13-0242/244BN	Concave Deck Hinge w/Pin & Lanyard	7/8"
F13-0301/244BN	Flat Deck Hinge w/Pin & Lanyard	7/8", 1" & 1-1/4"
F13-0302/244BN	Concave Deck Hinge w/Pin & Lanyard	7/8", 1" & 1-1/4"
F13-1085P	Flat Deck Hinge w/D-Ring, Port	7/8", 1" & 1-1/4"
F13-1085S	Flat Deck Hinge w/D-Ring, Starboard	7/8", 1" & 1-1/4"
F13-1095P	Concave Deck Hinge w/D-Ring, Port	7/8", 1" & 1-1/4"
F13-1095S	Concave Deck Hinge w/D-Ring, Starboard	7/8", 1" & 1-1/4"
Accessory		
F13-0244BN	Stainless Steel Pin & Lanyard w/Plastic Knob	-



TACO
MARINE



Canvas Top Fittings

Top Hardware "Standard"

Stainless Steel Type 316
Polished Finish

> Eye ends, jaw slides and bases available



F11-0100
F11-0107
F12-0101



F17-0106



F11-0160
F12-0161



F17-0166



F11-0172



F11-0174



F11-1000
F12-1001

Part #	Description	Tube	Bolt
Eye End			
F11-0100	Outside Eye End w/Set Screw	7/8"	1/4"
F11-0100N	Outside Eye End w/o Set Screw	7/8"	1/4"
F11-0107N	Outside Eye End w/o Set Screw	3/4"	1/4"
F12-0101	Outside Eye End w/Set Screw	1"	1/4"
F17-0106 ▼	Outside Eye End w/2 Set Screw	1-1/4"	1/4"
F11-0172	Inside Eye End	7/8" x .058"	1/4"
F11-0174	Inside Eye End	7/8" x .049"	1/4"
Jaw Slide			
F11-0160	Jaw Slide	7/8"	1/4"
F11-0160N	Jaw Slide w/o Set Screw	7/8"	1/4"
F11-1000	Jaw Slide w/Clamp-On	7/8"	1/4"
F12-0161	Jaw Slide	1"	1/4"
F12-1001	Jaw Slide w/Clamp-On	1"	1/4"
F17-0166 ▼	Jaw Slide w/Set Screw	1-1/4"	1/4"

▼Heavy-duty



CANVAS TOP FITTINGS

Top Hardware "Standard"

Stainless Steel Type 316

Polished Finish

- > Deck hinges and bases available

Nylon

- > Eye ends, jaw slides, bases and pole clips available



Canvas Top Fittings



F13-0200
F13-0220



F13-0210



F13-0230
F13-0235



F13-0240
F13-0246



F13-0250



F40-0278



F40-0300
F40-0302



F40-0504



F40-0718



F40-0878

Part #	Description	Length	Width	Tube	Bolt
Base					
F13-0200*	90° Base w/Bolt	2"	11/16"	-	1/4"- 20
F13-0210*	90° Base w/1/4" Toggle Pin	2"	11/16"	-	-
F13-0220*	90° Base	2"	11/16"	-	-
F13-0230*	80° Angle Base w/Bolt	2"	7/8"	-	1/4"- 20
F13-0235*	80° Angle Base w/o Bolt	2"	7/8"	-	-
F13-0240*	Concave Base w/Bolt	2"	7/8"	-	1/4"- 20
F13-0246*	Concave Base w/o Bolt	2"	11/16"	-	-
F13-0250*	2-Hole Side Mount w/Bolt	2"	1-7/8"	-	1/4"- 20
Nylon Top Hardware					
F40-0278BN	Inside Eye End, Black	-	-	7/8" x .058"	1/4"
F40-0278GRA	Inside Eye End, Gray	-	-	7/8" x .058"	1/4"
F40-0300GRA	Pole Clip, Gray	-	-	7/8"	1/4"
F40-0302GRA∞	Pole Clip, Gray	-	-	1"	1/4"
F40-0504BN*	90° Deck Hinge Base	2-3/8"	13/16"	-	10-24
F40-0718BN	Outside Eye End	-	-	7/8"	1/4"
F40-0878BN	Jaw Slide w/Set Screw, Black	-	-	7/8"	10-24
F40-0878GRA∞	Jaw Slide w/Set Screw, Gray	-	-	7/8"	10-24

*#10 Fasteners ∞Special Order





Pin & Lanyard

Stainless Steel Type 316

- > #10 fasteners
- > Sold in Pairs

Eye Strap

Stainless Steel Type 316 / Nylon

- > Multi-purpose use
- > Stainless Steel screws included

Curtain Track & Components

Aluminum / Nylon

- > Complete anodized Aluminum curtain track and nylon component system
- > Ideal for curtains in cutty, cabins and yachts



F13-0102

F13-0107

F13-0115

Part #	Description	Pin Grip	Pin Diameter
F13-0102T	6" Lanyard w/Ring	-	-
F13-0107T	Toggle Pin w/6" Lanyard & Tab	1"	1/4"
F13-0115∞	6" Lanyard w/Pull Pin	1-1/4"	3/8"

∞Special Order



F16-1200



F40-0704

Part #	Description	Length	Height	Width	ID	Color	Finish
F16-1200	Stamped Eye Strap	2"	11/16"	3/8"	1/2"	-	Polished
F40-0704BN	Nylon Eye Strap	1-7/8"	9/16"	1/2"	5/16"	Black	-

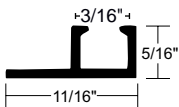

A52-0051 (Track)



F40-0112 (Sew-On Carrier)



F40-0119 (End Cap)

Part #	Description	Length	Height	Width	Depth	Color	Finish
A52-0051VEL12	Track	12'	5/16"	11/16"	-	-	Satin Anodized
F40-0112	Sew-On Carrier	-	1-1/4"	7/32"	7/32" (top)	White	-
F40-0119	End Cap	-	9/16"	11/16"	11/32"	White	-



CANVAS TOP FITTINGS

Canvas & Upholstery Welt & Track

Aluminum / Vinyl

- > For use on canvas tops, bolsters and other accessories

Upholstery Clip

Stainless Steel Type 304

Polished Finish

- > Used for mounting cushions and bolsters in place
- > Tumbled to remove burs and sharp edges to protect upholstery during installation
- > Offset for use with 1/4" substrate material

Flush Mount Base

Aluminum

Polished Anodized Finish

- > Ideal for Leaning Post backrest
- > Customize Leaning Post
- > Flexibility for fabricators



Canvas Top Fittings

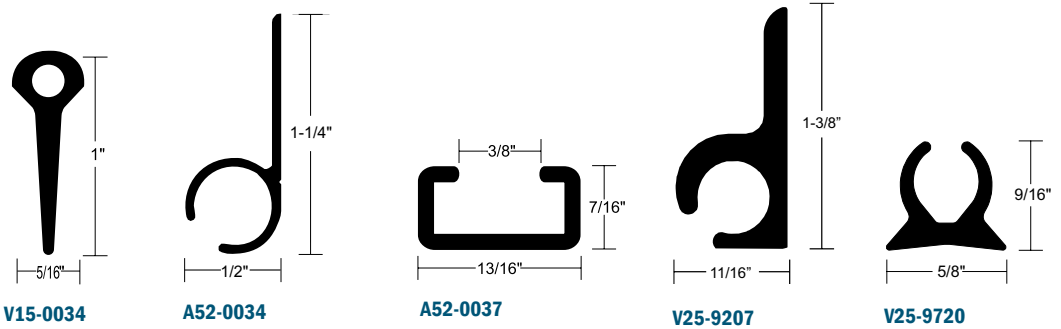

Part #	Length	Height	Width	Opening	Color	Style	Finish
Welt							
V15-0034	250'	1"	5/16"	-	Arctic White	Flexible PVC	-
Track							
A52-0034	16'	1-1/4"	1/2"	-	-	Aluminum	Brite Anodized
A52-0037	14'	7/16"	7/8"	3/8"	-	Aluminum	Brite Anodized
V25-9207	20'	1-3/8"	11/16"	-	Arctic White	Rigid PVC	-
V25-9720	20'	9/16"	5/8"	-	Frosty White	Rigid PVC	-



Part #	Description	Length	Width	Thick
F16-0094	Upholstery Clip	2-5/16"	3/4"	.078"



F34-0075



F34-0100

Part #	Description	Height	Pad Dia.	ID	OD	Screw
F34-0075BXY	Flush Mount Base for 3/4" Schedule 40 Pipe	3-1/2"	2-1/2"	1-1/16"	1-3/8"	#10
F34-0100BXY	Flush Mount Base for 1" Schedule 40 Pipe	3-1/2"	3"	1-1/2"	1-11/16"	#10





Boat Cover Pole

Boat Cover Pole

Aluminum

Anodized Finish

- > Telescoping boat cover pole with cam lock design
- > Helps prevent water stains and damage to boat
- > Available in two telescoping ranges: 24" to 45-1/2" and 30" to 57-1/2"



Part #	Description	Telescoping Range
T10-7579VEL2	Support Pole w/Snap-On End	24" to 45-1/2"
T10-7579VEL2.5	Support Pole w/Snap-On End	30" to 57-1/2"



RAIL FITTINGS

Hand Rail Fitting

Stainless Steel Type 316

Rectangle Base

- > Uses #10 oval head mounting screws

Rail Fitting

Stainless Steel Type 316

- > Available with round or rectangular base
- > Universal tees and elbows also available
- > Ideal for hand rails and bow rails



Rail Fittings



Center 60°



Aft 60°

Part #	Retail #*	Height	Tube	Base	Style
F14-0079	F14-0079-1	1-15/16"	7/8"	1-9/16" x 1-3/16"	Center 60°
F14-0081	F14-0081-1	1-15/16"	7/8"	1-9/16" x 1-3/16"	Aft 60°

*Blister pack (each)



Round
90° • 60°



Rectangle
90° • 60°



Elbows
90° - 2 Way



Universal Tees
60° • 90°

Part #	Retail #*	Tube	Base	Bolt	Style
Round Bases					
F14-0039	F14-0039-1	7/8"	2-5/8"	#10	90°
F14-0040	F14-0040-1	7/8"	2-5/8"	#10	60°
Rectangular Bases					
F14-0041	F14-0041-1	7/8"	3" x 1-3/4"	#10	90°
F14-0042	F14-0042-1	7/8"	3" x 1-3/4"	#10	60°
Universal Tees					
F14-0043	F14-0043-1	7/8"	-	-	90°
F14-0093	F14-0093-1	7/8"	-	-	60°
Elbows					
F14-0076	F14-0076-1	7/8"	-	-	90° - 2 Way

*Blister pack (each)





Round Tube

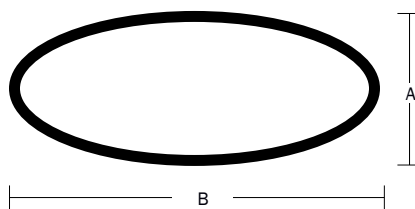
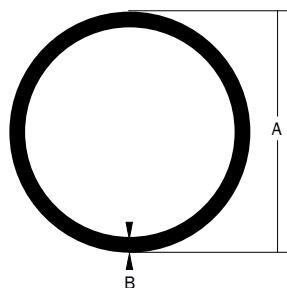

Round Tube

**Stainless Steel Type 304 /
Stainless Steel Type 316
Polished Finish**

- > Ideally suited for bow and grab rails, canvas top frames
- > Offered in a variety of sizes and wall thickness to suit wide range of applications
- > Ideal for using with Taco Marine Top Fittings

Elliptical Tube

**Stainless Steel Type 316
Polished Mirror Finish**

- > Stylish, elliptical tube with .060" wall thickness
- > Ideal for bow rails, radar arches, grab rails, spiral staircase railing and marine furniture
- > Ideal for using with Taco Marine Railing

Part #	Retail #	Length	"A"	"B"
Round				
S14-1049P12	S14-1049P12-1	12'	1"	.049"
S14-1049P20	S14-1049P20-1	20'	1"	.049"
S14-1049P20B*	-	20'	1"	.049"
-	S14-1049P6-1	6'	1"	.049"
S14-1065P20	S14-1065P20-1	20'	1"	.065"
S14-1065P24	-	24'	1"	.065"
S14-1065P24B*	-	24'	1"	.065"
S14-1265P20	-	20'	1-1/2"	.065"
S14-1465P20	-	20'	1-1/4"	.065"
S14-1465P24	-	24'	1-1/4"	.065"
S14-1465P24B*	-	24'	1-1/4"	.065"
S14-3449P20∞	-	20'	3/4"	.049"
S14-7849P12	S14-7849P12-1	12'	7/8"	.049"
S14-7849P20	S14-7849P20-1	20'	7/8"	.049"
S14-7849P24	-	24'	7/8"	.049"
-	S14-7849P6-1	6'	7/8"	.049"
S14-7865P20	S14-7865P20-1	20'	7/8"	.065"
S14-7865P24	-	24'	7/8"	.065"
S14-7865P24B*	-	24'	7/8"	.065"
Elliptical				
S17-1305PM20B	-	20'	1/2"	1-5/16"
S17-2078PM20B	-	20'	25/32"	2"

*Stainless Steel Type 316 ∞Special Order



ALUMINUM TUBE

Round Tube

Aluminum

Brite Anodized Finish

- > Close tolerances for consistent use with rail and top fittings
- > Available Drawn and Extruded
- > Ideal for t-tops and leaning post platforms

Square Tube

Aluminum

Brite Anodized Finish

- > Corners radiused .156"
- > Ideal for railings on pontoon boats

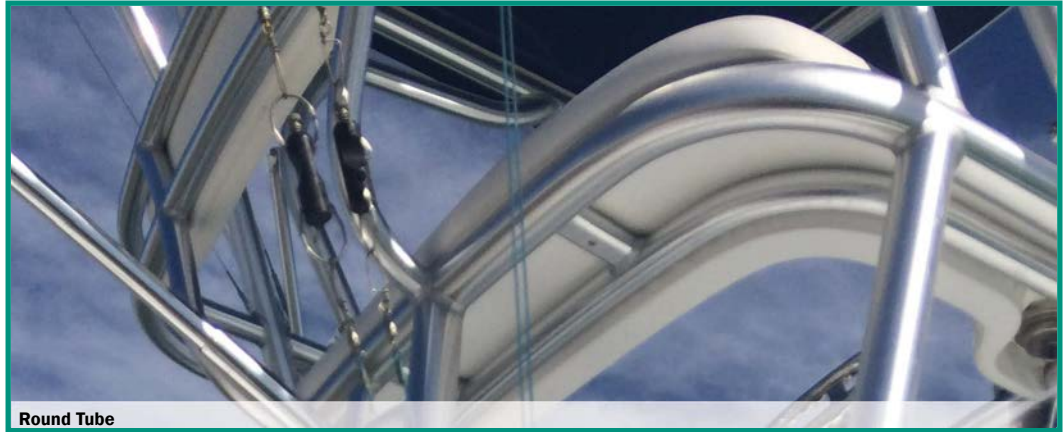

Round Tube

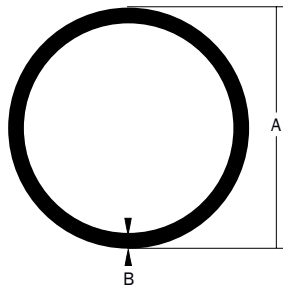

Part #	Retail #	Length	"A"	"B"
Drawn				
A23-1458BLY20 [∞]	-	20'	1-1/4"	.058"
A23-3458BLY20	-	20'	3/4"	.058"
-	A23-3458BLY6-1	6'	3/4"	.058"
A23-7858BLY12	A23-7858BLY12-1	12'	7/8"	.058"
A23-7858BLY16	-	16'	7/8"	.058"
A23-7858BLY20	A23-7858BLY20-1	20'	7/8"	.058"
A23-7858BLY24	-	24'	7/8"	.058"
-	A23-7858BLY6-1	6'	7/8"	.058"
A23-7895BLY24	-	24'	7/8"	.095"
Extruded				
A20-1464BLY20	-	20'	1"	.065"

[∞]Special Order

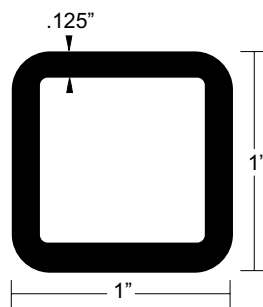

Part #	Length	Height	Width	Thick
A42-0360BXY24	24'	1"	1"	.125"





Oval Step Tread

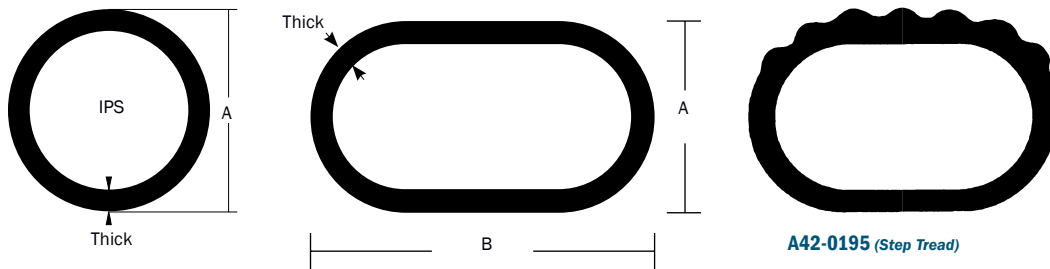

Round Pipe

Aluminum

- > Available as Schedule 40 or Schedule 80
- > Available in a variety of thicknesses
- > Designed for t-top, towers, leaning posts, poling platforms, bow rails, ski arches
- > Extruded to close tolerances

Oval Pipe

Aluminum

- > Ideal for step treads, grab rails, bow rails, canvas top and can be used on t-top for running wire chase

Part #	Length	IPS	"A"	"B"	Thick	Finish
Round, Aluminum Schedule 40						
A45-0352AES23-A	23'	3/4"	1-3/64"	-	.113"	Mill 320 Grit Sanded
A45-0352AEY20-A	20'	3/4"	1-3/64"	-	.113"	Mill
A45-0352BSA23-M	23'	3/4"	1-3/64"	-	.113"	320 Grit Brite Anodized
A45-0352BXY23-M	23'	3/4"	1-3/64"	-	.113"	Polished Brite Anodized
A45-0353AEY20-A	20'	1"	1-1/8"	-	.126"	Mill
A45-0353BSA23-M	23'	1"	1-1/8"	-	.126"	320 Grit Brite Anodized
A45-0353BXY23-M	23'	1"	1-1/8"	-	.126"	Polished Brite Anodized
A45-0354AEY20-A	20'	1-1/4"	1-19/32"	-	.140"	Mill
A45-0354BSA23-M	23'	1-1/4"	1-19/32"	-	.140"	320 Grit Brite Anodized
A45-0354BXY23-M	23'	1-1/4"	1-19/32"	-	.140"	Polished Brite Anodized
A45-0355AEY23-A	23'	1-1/2"	1-29/32"	-	.145"	Mill
A45-0355BSA23-M	23'	1-1/2"	1-29/32"	-	.145"	320 Grit Brite Anodized
A45-0355BXY23-M	23'	1-1/2"	1-29/32"	-	.145"	Polished Brite Anodized
A45-0356AEY20-A	20'	2"	2-3/8"	-	.154"	Mill
A45-0356BSA23-M	23'	2"	2-3/8"	-	.154"	320 Grit Brite Anodized
A45-0356BXY23-M	23'	2"	2-3/8"	-	.154"	Polished Brite Anodized
Round, Aluminum Schedule 80						
A45-8353BXY23-M	23'	1"	1-1/8"	-	.179"	Polished Brite Anodized
A45-8354BXY23-M	23'	1-1/4"	1-19/32"	-	.191"	Polished Brite Anodized
A45-8355BXY23-M	23'	1-1/2"	1-29/32"	-	.200"	Polished Brite Anodized
A45-8356BXY16-M	16'	2"	2-3/8"	-	.218"	Polished Brite Anodized
Oval						
A42-0055AEY20∞	20'	-	1-1/16"	1-7/8"	.125"	Mill
A42-0055BSA20°	20'	-	1-1/16"	1-7/8"	.125"	320 Grit Brite Anodized
A42-0136AEY20°	20'	-	1-1/4"	3"	.140"	Mill
A42-0136BSA20°	20'	-	1-1/4"	3"	.140"	320 Grit Brite Anodized
A42-0382BSA20°	20'	-	1-1/4"	4"	.140"	320 Grit Brite Anodized
Oval, Step Tread						
A42-0195BXY20°	20'	-	1"	1-1/2"	.125"	Polished Brite Anodized

*320 Grit finish on flat surface only °Step tread .047" Height ∞Special Order



ALUMINUM SHAPES

Structural Radius Angle / Straight Edge Angle

Aluminum

- > Available with radius at .25" or straight edge angle
- > Extruded for maximum strength

Structural Full Radius Edge Flat Bar

Aluminum

- > Provides seat-back support
- > Used on leaning posts, grab rails, t-top rings and mounting electronic boxes
- > Corner radius .25"

Structural Square Edge Flat Bar

Aluminum

- > Designed for mounting brackets on all fabricated applications
- > Corner radius .031"



Structural Radius Flat Bar

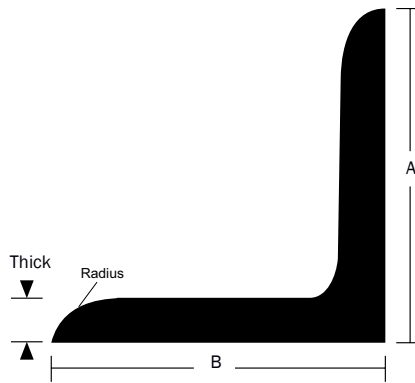

Radius

Part #	Length	"A"	"B"	Thick	Radius	Finish
A40-1043BXY20	20'	2"	2"	1/4"	.25"	Polished Brite Anodized
A40-1139AEY20∞	20'	2"	3"	1/8"	-	Mill
A40-1165AEY20∞	20'	3/4"	1-1/2"	1/8"	-	Mill
A40-1187AEY20	20'	1"	1"	1/8"	-	Mill
A40-1202AEY20∞	20'	2"	2"	1/8"	-	Mill
A40-1217AEY165∞	16-1/2'	1"	1-1/2"	3/32"	-	Mill
A40-2040AEY20∞	20'	2"	4"	1/8"	-	Mill

∞Special Order



Part #	Length	"A"	"B"	Finish
A40-0822AEY10	10'	1/2"	2"	Mill
A40-0822BXY12	12'	1/2"	2"	Polished Brite Anodized

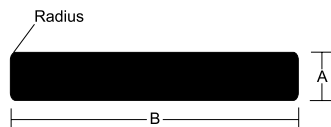

Part #	Length	"A"	"B"	Finish
A42-0363AEY12	12'	1/4"	2"	Mill
A42-0363BSA12	12'	1/4"	2"	320 Grit Brite Anodized
A42-0363BXY12	12'	1/4"	2"	Polished Brite Anodized
A42-0364AEY12	12'	1/4"	3"	Mill
A42-0364BSA12	12'	1/4"	3"	320 Grit Brite Anodized
A42-0364BXY12	12'	1/4"	3"	Polished Brite Anodized
A42-0365AEY12	12'	1/4"	4"	Mill
A42-0365BSA12	12'	1/4"	4"	320 Grit Brite Anodized
A42-0365BXY12	12'	1/4"	4"	Polished Brite Anodized





Pin

Aluminum

Anodized Finish

- > High-quality, precision fittings machined from 6000 series solid Aluminum for strength and anodized for long-lasting durability
- > Counter-bored with an air release hole to ensure fast preparation and consistent welding



Male Pin



Female Pin



Breakaway

Part #	IPS	Hole	Bolt	Finish
Male Pin				
F30-1821BLY	3/4"	1/4"	-	Brite Anodized
F30-1831AEY	1"	5/16"	-	Mill
F30-1831BLY	1"	5/16"	-	Brite Anodized
F30-1841BLY	1-1/4"	3/8"	-	Brite Anodized
F30-1851BLY	1-1/2"	3/8"	-	Brite Anodized
Female Pin				
F30-1823BLY*	3/4"	-	1/4"	Brite Anodized
F30-1833BLY*	1"	-	5/16"	Brite Anodized
F30-1843AEY*	1-1/4"	-	3/8"	Mill
F30-1843BLY*	1-1/4"	-	3/8"	Brite Anodized
F30-1853BLY*	1-1/2"	-	7/16"	Brite Anodized
Breakaway Pin				
F30-2300BLY	1"	-	5/16"	Brite Anodized
F30-2400BLY	1-1/4"	-	3/8"	Brite Anodized
F30-2500BLY	1-1/2"	-	3/8"	Brite Anodized
F30-2555AEY**	1-1/2"	-	3/8"	Mill
F30-2555BLY**	1-1/2"	-	3/8"	Brite Anodized

*Includes 2 Delrin washers for extra smooth rotation **Wake tower pin - 180° rotation



TOP & TOWER HARDWARE

Pad

Aluminum

Anodized Finish

- > High quality, precision machined pads
- > Solid, anodized 6000 series Aluminum stock
- > Center bleed holes vent air during welding
- > 1/4" screw
- > 1/4" thick



Round Pad with 4 Holes



3 Hole (Small Center Hole)



3 Hole (Large Center Hole)



4 Hole (Round)

Part #	Length	Width	OD	IPS	Ctr. Hole	Holes	Finish
Round							
F32-4025AEY-A	-	-	2-1/2"	-	3/8"	0	Mill
F32-4025BSS	-	-	2-1/2"	-	3/8"	0	Spiral Sanded
F32-4025BXY	-	-	2-1/2"	-	3/8"	0	Polished Brite Anodized
F32-4125BLY	-	-	2-1/2"	-	3/8"	1 (Threaded)	Brite Anodized
F32-4330AEY	-	-	3"	3/4"	3/8"	3	Mill
F32-4330BSS	-	-	3"	3/4"	3/8"	3	Spiral Sanded
F32-4330BXY	-	-	3"	3/4"	3/8"	3	Polished Brite Anodized
F32-4335AEY	-	-	3-1/2"	1"	3/8"	3	Mill
F32-4335BSS	-	-	3-1/2"	1"	3/8"	3	Spiral Sanded
F32-4335BXY	-	-	3-1/2"	1"	3/8"	3	Polished Brite Anodized
F32-4340AEY	-	-	4"	1-1/4"	3/8"	3	Mill
F32-4340BSS	-	-	4"	1-1/4"	3/8"	3	Spiral Sanded
F32-4340BXY	-	-	4"	1-1/4"	3/8"	3	Polished Brite Anodized
F32-4345AEY	-	-	4-1/2"	1-1/2"	3/8"	3	Mill
F32-4345BXY	-	-	4-1/2"	1-1/2"	3/8"	3	Polished Brite Anodized
F32-4350BSS	-	-	5"	2"	3/8"	3	Spiral Sanded
F32-4435BXY	-	-	3-1/2"	1"	3/8"	4	Polished Brite Anodized
F32-4440AEY	-	-	4"	1-1/4"	3/8"	4	Mill
F32-4440BSS	-	-	4"	1-1/4"	3/8"	4	Spiral Sanded
F32-4440BXY	-	-	4"	1-1/4"	3/8"	4	Polished Brite Anodized
F32-4445AEY	-	-	4-1/2"	1-1/2"	3/8"	4	Mill
F32-4445BSS	-	-	4-1/2"	1-1/2"	3/8"	4	Spiral Sanded
F32-4445BXY	-	-	4-1/2"	1-1/2"	3/8"	4	Polished Brite Anodized
F32-4450AEY	-	-	5"	2"	3/8"	4	Mill
F32-4450BSS	-	-	5"	2"	3/8"	4	Spiral Sanded
F36-4340BXY-8	-	-	4"	1-1/2"	1-5/16"	3	Polished Brite Anodized
F36-4440BXY-1 [▼]	-	-	4"	1-1/2" & 2"	3/8"	4	Polished Brite Anodized
Rectangle							
F32-2040AEY	4"	2"	-	1"	3/8"	4	Mill
F32-2040BSY	4"	2"	-	1"	3/8"	4	180 Grit Brite Anodized
F32-3040AEY	4"	3"	-	1" & 1-1/4"	3/8"	4	Mill
F32-3040BSY	4"	3"	-	1" & 1-1/4"	3/8"	4	180 Grit Brite Anodized
F32-3040BXY	4"	3"	-	1" & 1-1/4"	3/8"	4	Polished Brite Anodized

[▼]Offset hole configuration for swept back t-top legs [■]Tapped center hole is for screwing down on top of fiberglass - not for pipe





Radiused Specialty Pad

Radiused Specialty Pad

Aluminum

Anodized Finish

- > High-quality, precision machined pads
- > Solid, anodized 6000 series Aluminum stock
- > Variety of shapes and hole configurations
- > Center bleed holes vent air during welding
- > 1/4" screw
- > 1/4" thick



F32-0600
F32-0650



F32-3043



F32-3355



F32-4160



F36-3040



4 Hole (Rectangle)



0 Hole

Part #	Length	Width	IPS	Ctr. Hole	Holes	Finish
F32-0600AEY	3-3/8"	2"	1"	1/4"	2	Mill
F32-0600BXY	3-3/8"	2"	1"	1/4"	2	Polished Brite Anodized
F32-0600BXZ	3-3/8"	2"	1"	1/4"	2	800 Grit Brite Anodized
F32-0650AEY	3-1/2"	2"	1"	1/4"	2	Mill
F32-0650BXY	3-1/2"	2"	1"	1/4"	2	Polished Brite Anodized
F32-3043AEY	4-3/8"	3"	1-1/4" & 1-1/2"	3/8"	4	Mill
F32-3043BSY-320	4-3/8"	3"	1-1/4" & 1-1/2"	3/8"	4	320 Grit Brite Anodized
F32-3043BXY	4-3/8"	3"	1-1/4" & 1-1/2"	3/8"	4	Polished Brite Anodized
F32-3043BXZ	4-3/8"	3"	1-1/4" & 1-1/2"	3/8"	4	800 Grit Brite Anodized
F32-3355BXY	5-1/2"	3-3/4"	1-1/4"	0	6	Polished Brite Anodized
F32-4160AEY [∞]	6"	4"	1-1/2"	1/4"	4	Mill
F32-4160BXZ [∞]	6"	4"	1-1/2"	1/4"	4	800 Grit Brite Anodized
F36-3040AEY-2	4"	3"	1" & 1-1/4"	1/2"	4	Mill
F36-3040BXY-2	4"	3"	1" & 1-1/4"	1/2"	4	Polished Brite Anodized

[∞]Special Order



TOP & TOWER HARDWARE

Pad Assembly

Aluminum

Anodized Finish

- > High-quality, precision machined pads
- > Solid, anodized 6000 series Aluminum stock
- > Counter-bored with air release to ensure fast preparation and consistent welding
- > 1/4" screw with 4 holes

Specialty Hardware for Wake Tower

Aluminum

Anodized Finish

- > Used to build and equip wake towers and arches
- > Assortment includes knob



Tower Hardware



F35-W404



F35-SDW125

Part #	OD	IPS	Mating Pipe
Male			
F35-W404	4"	1-1/4"	F30-1843/F30-1853
Female			
F35-SDW125*	4"	1-1/4"	F30-1841
F36-1836BLY	1-19/64"	1"	F30-1831

*Includes 2 Delrin washers for extra smooth rotation



F30-1751



F30-1852



F30-2150



F36-7001



F40-0024

Part #	Description	IPS	Bolt	Style	Color/Finish
F30-1751BLY	Half Pin & Swivel Stud	1-1/2"	3/8"	Half Pin - 180° Rotation	Brite Anodized
F30-1852BLY	Male Pin & Swivel Stud	1-1/2"	3/8"	Male Pin - 180° Rotation	Brite Anodized
F30-2150BLY	Female Pin	1-1/2"	3/8"	Coped Base	Brite Anodized
F36-7001BLY	Ski Ball Assembly w/Delrin Insert	1-1/2"	-	-	-
F40-0024BLK	Soft Touch Knob	-	3/8"	-	Black





Weld-On Extrusion Plate

Extrusion Plate

Aluminum

Linear Sanded Finish

- > Heavy-duty, suited for a variety of applications and widely used for outrigger mounts
- > Offered pre-drilled for easy mounting of Grand Slam 280 and 380 outrigger mounts
- > Conceals wiring
- > Sold in Pairs

Leaning Post Pins & Pads

Aluminum

Anodized Finish

Leaning Post Footrest Hinge

Aluminum

Polished Anodized Finish

- > 1" IPS pipe

Patent #6,851,654

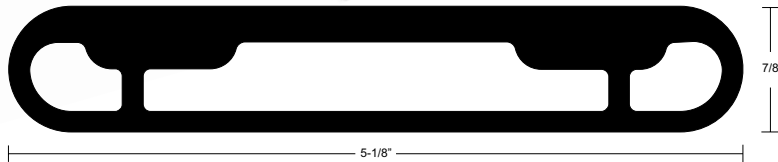

Part #	Description	Length	Height	Width	Finish
GSE-1939BLS30	Pre-Drilled Grand Slam Extrusion	30"	7/8"	5-1/8"	Linear Sanded
GSE-1939BSA20	Pre-Drilled Grand Slam Extrusion, 20"	20"	7/8"	5-1/8"	320 Grit Brite Anodized
GSE-1939BSA28-C	Pre-Drilled Grand Slam Extrusion, 28"	28"	7/8"	5-1/8"	320 Grit Brite Anodized



F30-0021 w/F35-FRB



F35-FRB

Part #	Description	Length	Width	Hole	IPS	Finish
F30-0021BLY	Female Ear & Pin w/Washers	1"	3/8"	3/8"	1"	Brite Anodized
F35-FRB	Folding Footrest Pad - 5/16" Thick	2"	2-1/2"	5/16"	-	180 Grit Anodized

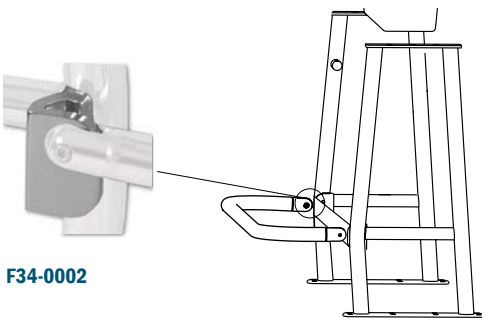

F34-0002

Part #	Description	Height	Width	Depth	Finish
F34-0002BXY	Recessed Hinge	2-7/8"	2"	1-9/16"	Polished Brite Anodized
F34-0022AEY-P	Footrest Hinge, Port	2"	2"	2-19/32"	Mill
F34-0022AEY-S	Footrest Hinge, Starboard	2"	2"	2-19/32"	Mill
F34-0022BSY	Footrest Hinge Set, Port & Starboard	2"	2"	2-19/32"	180 Grit Brite Anodized



ROD HOLDERS

Weld-On Rod Holder, Flared

Aluminum

- > Weld to towers, t-tops, radar arches, railings and leaning posts
- > Welded I-Beam securely seats rod butt
- > Form-fitted anti-fungal Vinyl liner included



Weld-On Rod Holders

INCLUDES FORM-FITTED ANTI-FUNGAL PVC LINER



F31-2200
F31-2240
F31-2300 (Black Liner)



F31-2230



F31-2320 (Black Liner)

Part #	Length	ID	Blade	Finish
F31-2200AEY-4A	9-3/4"	1-3/4"	Bladeless	Mill
F31-2200BSA-4A	9-3/4"	1-3/4"	Bladeless	320 Grit Brite Anodized
F31-2200BXY-4A	9-3/4"	1-3/4"	Bladeless	Polished Brite Anodized
F31-2230AEY-4A	9-3/4"	1-3/4"	3/8" Coped Blade	Mill
F31-2230BXY-4A	9-3/4"	1-3/4"	3/8" Coped Blade	Polished Brite Anodized
F31-2240BXY-4A	8-1/2"	1-3/4"	Bladeless	Polished Brite Anodized
F31-2300AEY-4A	10-1/4"	1-7/8"	Bladeless	Mill
F31-2300BXY-4	10-1/4"	1-7/8"	Bladeless	Polished Brite Anodized
F31-2320BXY-4	10-1/4"	1-7/8"	Scalloped Blade	Polished Brite Anodized





Traditional Rod Holder / Deck Mount Rod Holder

Aluminum

Polished Brite Anodized Finish

- > Bladeless weld-on Rod Holders
- > Weld to towers, t-tops, radar arches, railings and leaning posts
- > Welded I-Beam securely seats rod butt
- > Form-fitted anti-fungal Vinyl liner included
- > Deck mount style has welded pin design

INCLUDES FORM-FITTED ANTI-FUNGAL PVC LINER



F31-1600



Slotted for spinning reels

F31-1610



F31-0700



F31-0751

ALSO SOLD SEPARATELY

Flared & Straight Liner (pg SF37)



Part #	Description	Length	ID	Finish
F31-1600BXY-4A	Traditional	8-1/2"	1-1/2"	Polished Brite Anodized
F31-1610AEY	Slotted Traditional	8-1/2"	1-1/2"	Mill
F31-1610BXY-4A	Slotted Traditional	8-1/2"	1-1/2"	Polished Brite Anodized
F31-1610BXYD-4A	Slotted Traditional, Drilled	8-1/2"	1-1/2"	Polished Brite Anodized
F31-0700BXY	10° Angle, Round Flange w/Welded Pin Design	8-1/2"	1-1/2"	Polished Brite Anodized
F31-0751BXY	10° Angle, Rectangle Flange	8"	1-1/2"	Polished Brite Anodized



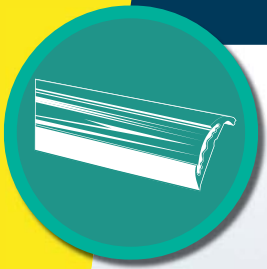

RUB RAIL





Rigid Vinyl Rub Rail Accepts Flex Chrome Insert

- > Elegant look of Stainless Steel without the high cost and labor
- > Clean, smooth, polished look
- > Easy handling and flexible
- > Installs with no fasteners
- > End caps available for select Rub Rails
- > Ideal for up to 30' boats

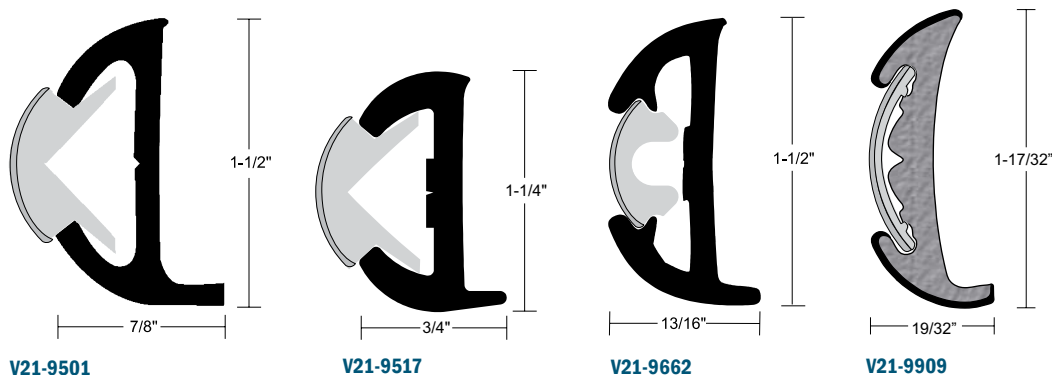

PRODUCT KNOWLEDGE
TM

Patented, flexible Vinyl Flex Chrome insert offers an elegant Stainless Steel look at a much lower cost. Co-extruded, specially formulated chrome mylar is applied and laminated in-line to the surface of the extruded flexible Vinyl insert. Flex Chrome Insert is available in three styles: V12-0307, V12-1069 and V12-9809 located on page RR78.

V21-9662 shown with V12-1069 Flex Chrome Insert



Part #	Color	Length	Height	Width	Screw	Insert
V21-9501WHC20D	Frosty White	20'	1-1/2"	7/8"	#10*	V12-0307
V21-9517BKA20D	Black	20'	1-1/4"	3/4"	#10*	V12-0307
V21-9662WHC20D	Frosty White	20'	1-1/2"	13/16"	#8▼	V12-1069
V21-9909BKA70D	Black	70'	1-17/32"	19/32"	#8▼	V12-9809
V21-9909WHC70D	Frosty White	70'	1-17/32"	19/32"	#8▼	V12-9809

*Drilled and countersunk on 6" centers ▼Drilled and countersunk on 8" centers ▾Drilled only on 6" centers



RIGID VINYL RUB RAIL

Rigid Vinyl Rub Rail Accepts Stainless Steel Insert

- > Elegant and durable
- > Bendable to conform with hull shape
- > End caps available for select Rub Rails
- > Drilled and countersunk on 8" centers
- > Ideal for up to 40' boats

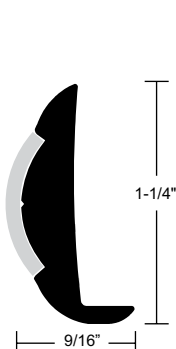

V21-9648

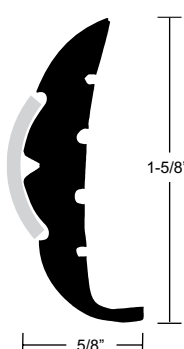

V21-9659

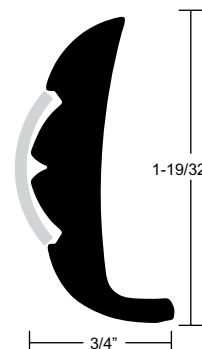

V21-9866

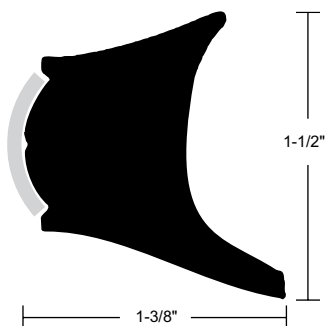

V21-1025

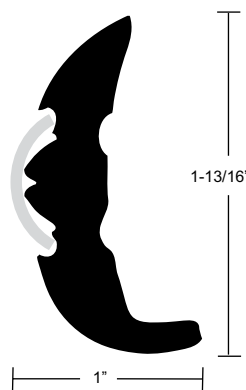

V21-9679

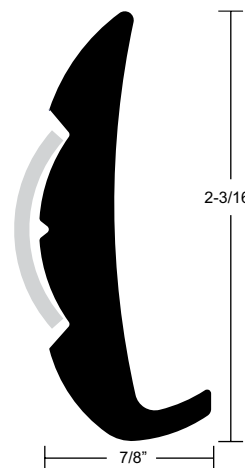

V21-9790

Part #	Color	Length	Height	Width	Screw	Insert
V21-1025WHC20D	Frosty White	20'	1-1/2"	1-3/8"	#10*	S11-4511
V21-9648WHC20D	Frosty White	20'	1-1/4"	9/16"	#8	S11-4511
V21-9659BKA20D	Black	20'	1-5/8"	5/8"	#8	S11-4511
V21-9679BKA20D	Black	20'	1-13/16"	1"	#8	S11-4511
V21-9679WHC20D	Frosty White	20'	1-13/16"	1"	#8	S11-4511
V21-9790BKA20D	Black	20'	2-3/16"	7/8"	#10	S11-4650
V21-9866WHC20D	Frosty White	20'	1-19/32"	3/4"	#8	S11-4511

*Drilled and countersunk on 6" centers





Flex Core Accepts Stainless Steel Insert

- > Lightweight
- > Easy handling and installation
- > Solid, rigid PVC cap stock exhibits traditional surface characteristics, appearance and impact properties
- > 50' and 60' are available in a continuous coil eliminating butt joints around gunwale
- > Improved bending characteristics and ability to cold form
- > Vacuum calibration tooling allows for tighter dimensional tolerance and sizing consistency
- > High-density core offers improved shock-absorbent impact resistance
- > Drilled and countersunk on 8" centers
- > End caps available for select Rub Rails

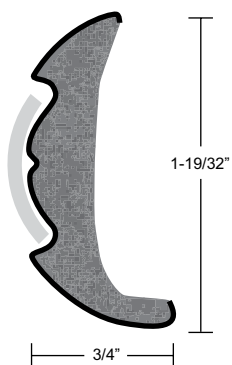

V21-9923

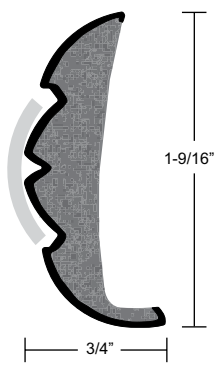

V21-9959

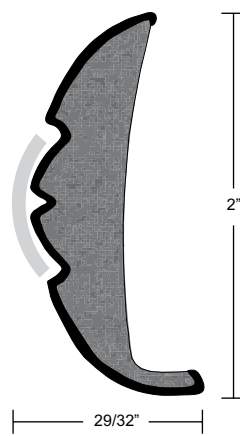

V21-9906

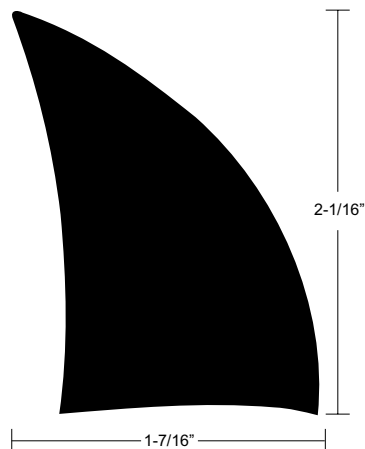

V21-0874

PRODUCT KNOWLEDGE
TM

Spray Rail is a Rigid Vinyl Rub Rail designed to provide protection from water spray and keep the boat dry. The wetness reduction of 50-60% when installed properly onto the hull makes this Rub Rail worth the expense. It also adds lift to your boat making for a faster boat!

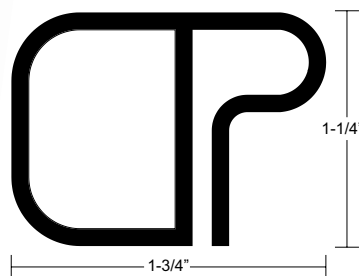

V21-9140

Spray Rail

- > Provides protection against water spray
- > Keeps boat dry and improves performance and speed through lift
- > 50-60% wetness reduction
- > Undrilled

Canoe Rail

- > Fits hull thickness 1/4" - 3/8"
- > Specially designed built-in hand grip
- > Fits a wide variety of canoes
- > Offers additional structural support
- > Undrilled

Part #	Color	Length	Height	Width	Screw	Insert
V21-9923BKA60D	Black	60'	1-19/32"	3/4"	#8	S11-4511
V21-9923WHC60D	Frosty White	60'	1-19/32"	3/4"	#8	S11-4511
V21-9959BKA20D	Black	20'	1-9/16"	3/4"	#8	S11-4511
V21-9959BKA50D	Black	50'	1-9/16"	3/4"	#8	S11-4511
V21-9959WHC20D	Frosty White	20'	1-9/16"	3/4"	#8	S11-4511
V21-9959WHC50D	Frosty White	50'	1-9/16"	3/4"	#8	S11-4511
V21-9959WHC60D	Frosty White	60'	1-9/16"	3/4"	#8	S11-4511
V21-9906BKA20D	Black	20'	2"	29/32"	#8	S11-4511
V21-9906BKA60D	Black	60'	2"	29/32"	#8	S11-4511
V21-9906WHC20D	Frosty White	20'	2"	29/32"	#8	S11-4511
V21-9906WHC50D	Frosty White	50'	2"	29/32"	#8	S11-4511
V21-9906WHC60D	Frosty White	60'	2"	29/32"	#8	S11-4511
V21-0874WHA18	Arctic White	18'	2-1/16"	1-7/16"	-	-
V21-9140BKA166	Black	16' 6"	1-1/4"	1-3/4"	-	-



RIGID VINYL RUB RAIL

Rigid Vinyl Rub Rail Accepts Stainless Steel Insert for Large Boats

- > Drilled and countersunk on 6" and 12" centers
- > End caps available for select Rub Rails
- > Ideal for boats up to 50'

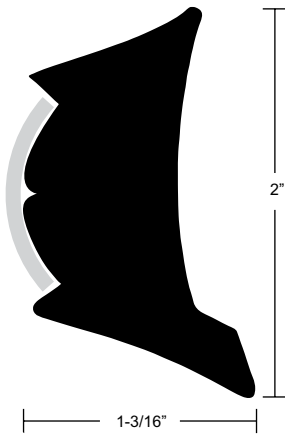

V21-1039

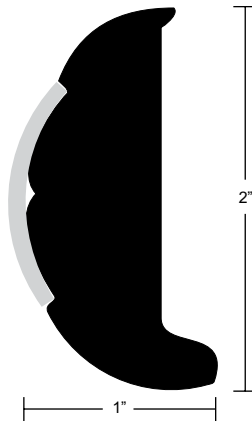

V21-9502

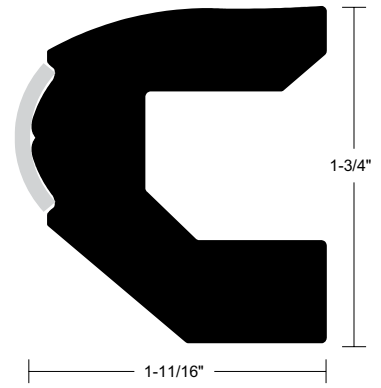

V21-9647

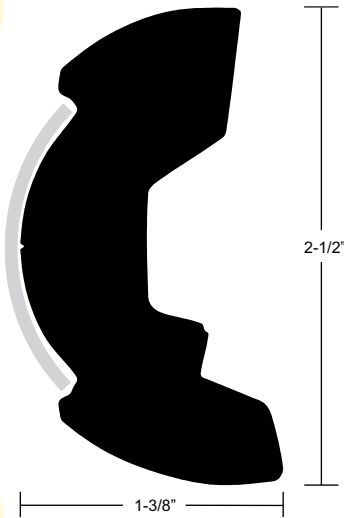

V21-9667

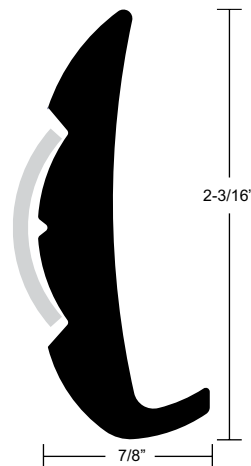

V21-9790

Part #	Color	Length	Height	Width	Screw	Insert
V21-1039BKA20D1	Black	20'	2"	1-3/16"	#8"	S11-4650
V21-9502BKA20D	Black	20'	2"	1"	#8*	S11-4650
V21-9502WHC20D	Frosty White	20'	2"	1"	#8*	S11-4650
V21-9647WHA20D	Arctic White	20'	1-3/4"	1-11/16"	#10"	S11-4511
V21-9667WHC20D	Frosty White	20'	2-1/2"	1-3/8"	#10*	S11-4650
V21-9790BKA20D	Black	20'	2-3/16"	7/8"	#10*	S11-4690

*Drilled and countersunk on 6" centers *Drilled and countersunk on 12" centers



RIGID VINYL RUB RAIL

RUB RAIL



Rigid Vinyl Rub Rail Accepts Flexible Insert

- > Covers fasteners and provides soft cushioning'
- > Drilled and countersunk on 8" centers
- > End caps available for select Rub Rails
- > Ideal for boats up to 30'

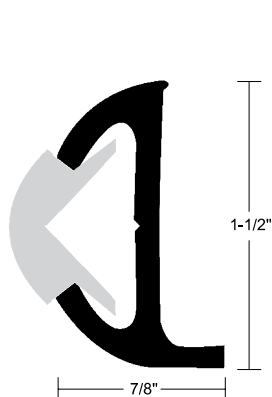

V21-9501

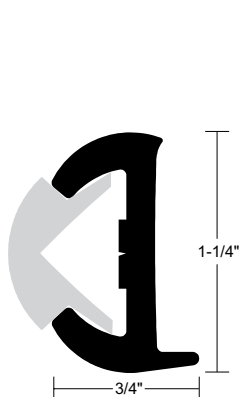

V21-9517

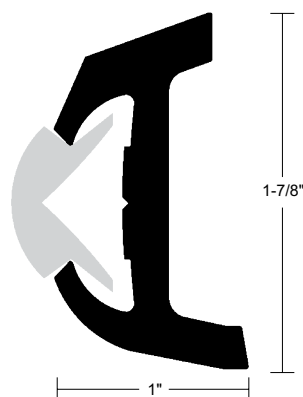

V21-9602

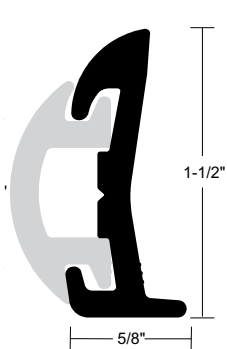

V21-9678

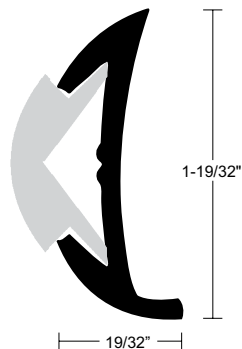

V21-9904

Part #	Color	Length	Height	Width	Screw	Insert
V21-9501WHC20D	Frosty White	20'	1-1/2"	7/8"	#10 [■]	V12-0303
V21-9517BKA20D	Black	20'	1-1/4"	3/4"	#10 [•]	V12-0303
V21-9602WHA20D	Arctic White	20'	1-7/8"	1"	#10	V12-0303
V21-9678BKA20D	Black	20'	1-1/2"	5/8"	#8	V12-4144
V21-9678WHA20D	Arctic White	20'	1-1/2"	5/8"	#8	V12-4144
V21-9904BKA20D	Black	20'	1-19/32"	19/32"	#8	V12-0303
V21-9904WHC20D	Frosty White	20'	1-19/32"	19/32"	#8	V12-0303

*Drilled and countersunk on 6" centers * Drilled only on 6" centers



TACO
MARINE

RR65

RIGID VINYL RUB RAIL

Rigid Vinyl Rub Rail Accepts No Insert

- > Drilled and countersunk on 6" centers
- > End caps available for select Rub Rails
- > Ideal for boats up to 30'

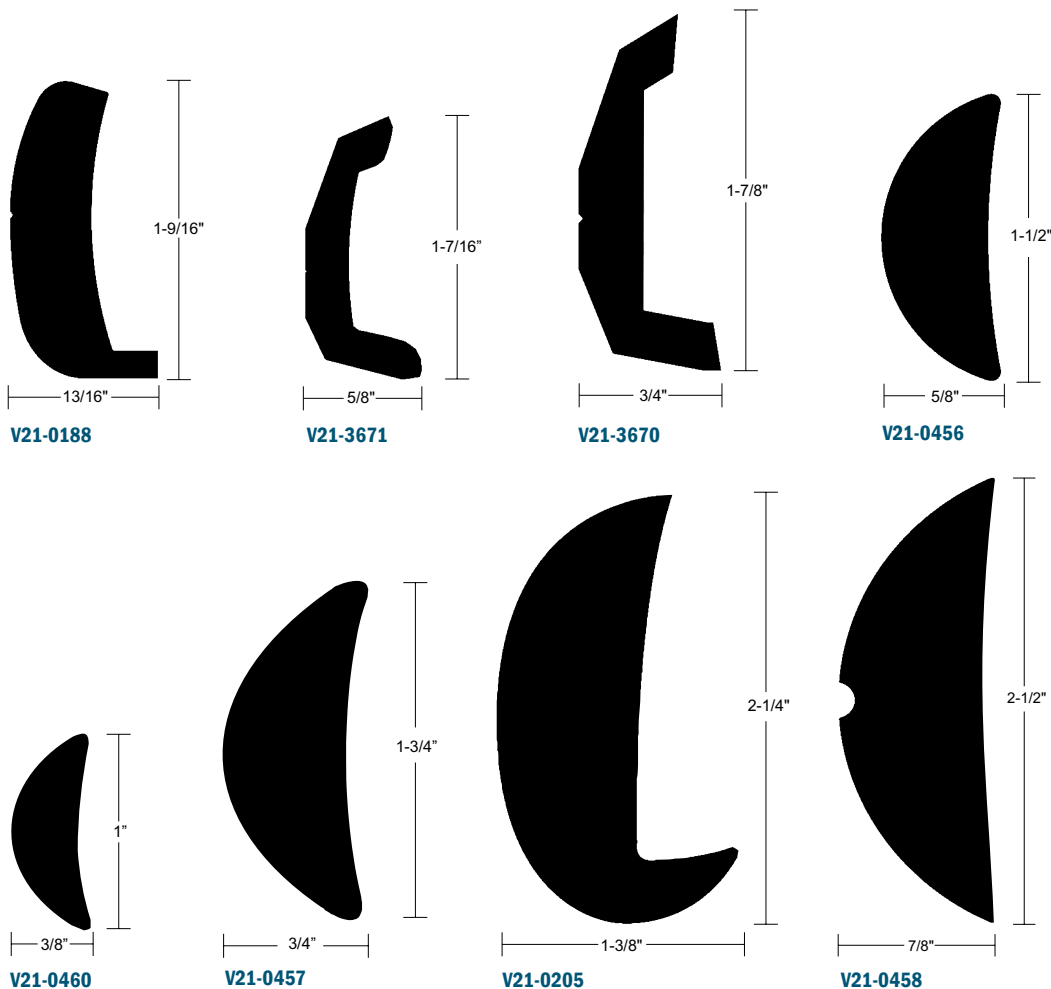

Part #	Retail #*	Color	Length	Height	Width	Screw
V21-0188BKA20D	-	Black	20'	1-9/16"	13/16"	#8
V21-0205BKA20D	-	Black	20'	2-1/4"	1-3/8"	#10 [▼]
V21-0456BKA12D	-	Black	12'	1-1/2"	5/8"	#8
V21-0457BKA20D	-	Black	20'	1-7/8"	3/4"	#8
V21-0458BKA20D	-	Black	20'	2-1/2"	7/8"	#10
V21-0460BKA12D	-	Black	12'	1"	3/8"	#6
V21-3670BKA20D	V21-3670BKA20D-1	Black	20'	1-7/8"	3/4"	#10 [▼]
V21-3670WHA20D	-	Arctic White	20'	1-7/8"	3/4"	#10 [▼]
V21-3671BKA20D2	-	Black	20'	1-7/16"	5/8"	#10 [▼]
V21-3671WHA20D2	-	Arctic White	20'	1-7/16"	5/8"	#10 [▼]

*Drilled and countersunk on 8" centers *Boxed and coiled for shipping compliance



SEMI-RIGID VINYL RUB RAIL

RUB RAIL



Semi-Rigid Vinyl Rub Rail Accepts Stainless Steel Insert

- > End caps available for select Rub Rails
- > Also available as a kit that includes Rub Rail, insert, end caps and Stainless Steel screws

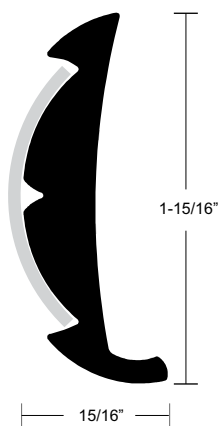

V11-9669

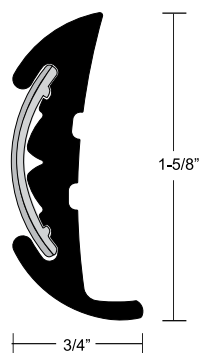

V21-9811

PRODUCT KNOWLEDGE



V21-9811 is also available as a Rub Rail Kit with everything needed for a DIY installation. Kit includes Rub Rail with insert, end caps and Stainless Steel screws.

Part #	Color	Length	Height	Width	Screw	Insert
V11-9669WHA100	Arctic White	100'	1-15/16"	15/16"	#8*	S11-4690
V21-9811BKA20D	Black	20'	1-5/8"	3/4"	#8*	V12-9809
V21-9811WHD20D	Silver White	20'	1-5/8"	3/4"	#8*	V12-9809

*Drilled and countersunk on 6" centers



TACO
MARINE

RR67

FLEXIBLE VINYL RUB RAIL

Flexible Vinyl Rub Rail Accepts Flexible Vinyl Insert

- > Easy handling makes these Rub Rails a good choice for DIY boaters
- > Continuous coil for seamless, one-piece installation
- > Tight radius bending accomplished with minimal heating
- > End caps available for select Rub Rails
- > Select Rub Rails also available as a kit that includes Rub Rail, insert, end caps and Stainless Steel screws



PRODUCT KNOWLEDGE



V11-0809, V11-2423, V11-3426 and V11-3447 available as a Rub Rail Kit with everything needed for a DIY installation (see page RR71).

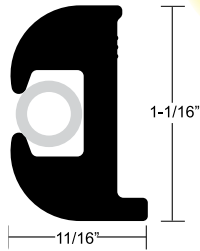

V11-0809

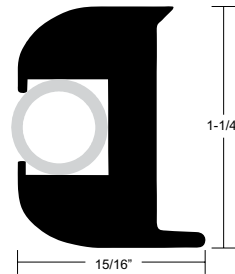

V11-3447

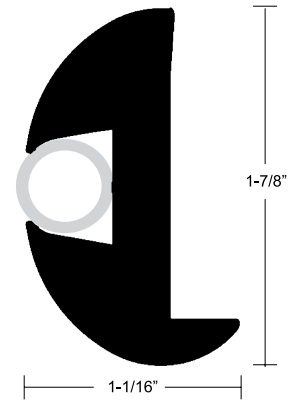

V11-2423

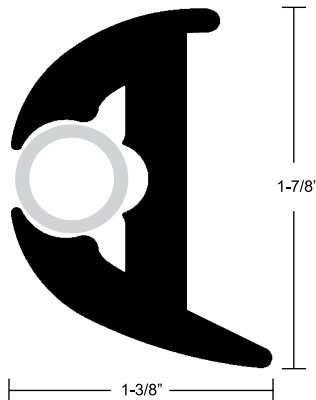

V11-3426

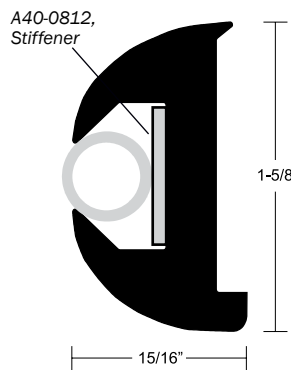

V11-4014 (Shown w/A40-0812)

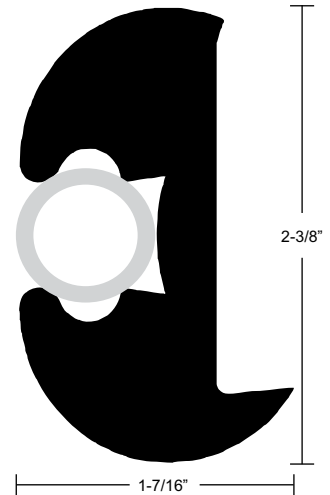

V11-0899

Part #	Retail #*	Color	Length	Height	Width	Screw	Insert
-	V11-0809BKA50-1	Black	50'	1-1/16"	11/16"	#8	V12-0810
V11-0899BKA100	-	Black	100'	2-3/8"	1-7/16"	#10	V12-0005
-	V11-2423BKA50-1	Black	50'	1-7/8"	1-1/16"	#10	V12-0003
-	V11-2423BKA70-1	Black	70'	1-7/8"	1-1/16"	#10	V12-0003
V11-2423BKA100	-	Black	100'	1-7/8"	1-1/16"	#10	V12-0003
-	V11-3426BKA50-1	Black	50'	1-7/8"	1-3/8"	#8	V12-0005
-	V11-3426BKA70-1	Black	70'	1-7/8"	1-3/8"	#8	V12-0005
-	V11-3447BKA50-1	Black	50'	1-1/4"	15/16"	#8	V12-0003
V11-4014BKA70*	-	Black	70'	1-5/8"	15/16"	#8	V12-0003

*Boxed and coiled for shipping compliance



FLEXIBLE VINYL RUB RAIL

RUB RAIL

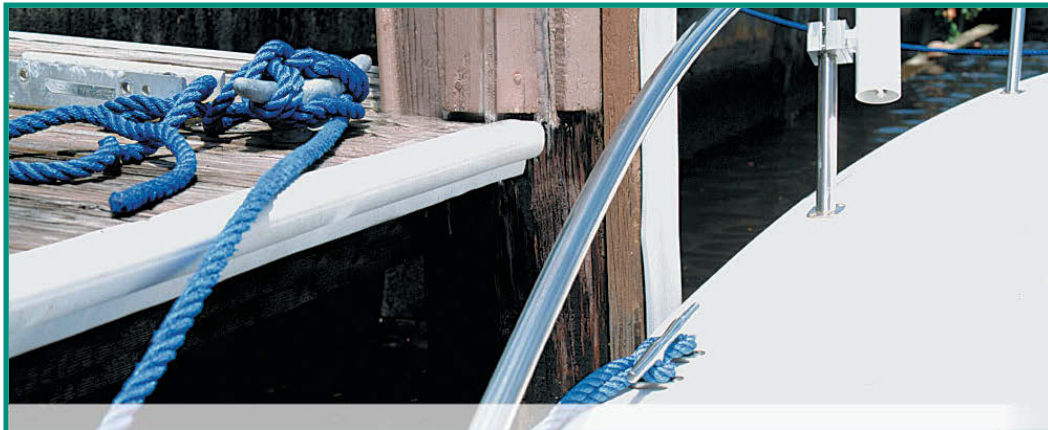

Dock Bumper

- > Soft durometer absorbs impact and protects dock and boat from damage during docking
- > Continuous coil allows seamless, one-piece installation
- > Tight radius bending can be done with no heating

Sandwich-Style

- > Easy handling makes these Rub Rails a good choice for DIY boaters
- > Continuous coil for seamless, one-piece installation
- > Tight radius bending accomplished with minimal heating
- > End caps available for select Rub Rails

U-Shape Flexible Vinyl Moulding

- > Designed for "rolled edge" gunnels
- > Easily installs with rubber mallet
- > No fasteners needed
- > Flexibility allows for easy forming

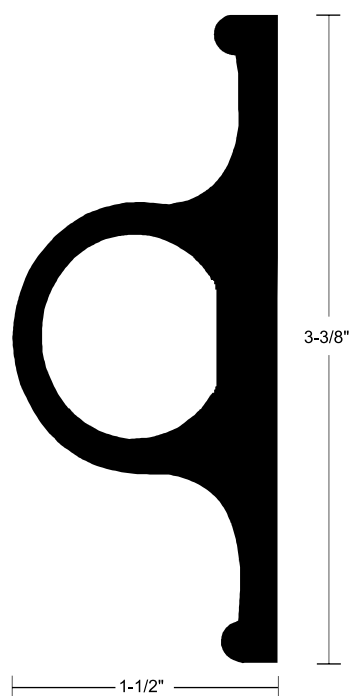

V11-0948

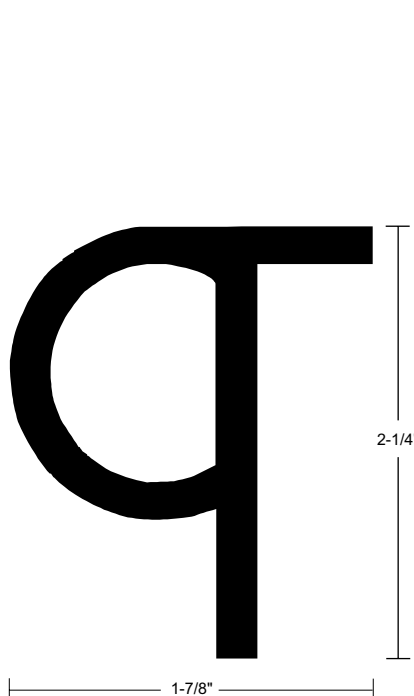

V11-0961

PRODUCT KNOWLEDGE
IM "Sandwich-Style" Rub Rail caps over deck and hull joint and is typically used on sailboats.

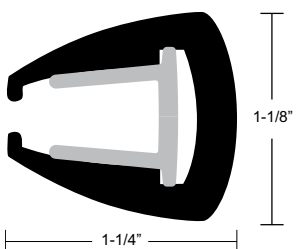

V11-3161

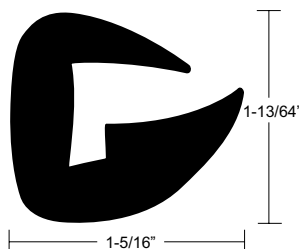
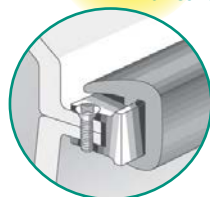

V15-9855

Part #	Retail #*	Color	Length	Height	Width	Insert
V11-0948WHA20∞	-	Arctic White	20'	3-3/8"	1-1/2"	-
V11-0961WHA25∞	-	Arctic White	25'	2-1/4"	1-7/8"	-
-	V11-3161BKA50-1	Black	50'	1-1/8"	1-1/4"	V22-3162
V15-9855BKA250	-	Black	250'	1-13/64"	1-5/16"	-

*Boxed and coiled for shipping compliance ∞Special Order



RUB RAIL KITS

Semi-Rigid Vinyl Rub Rail Kit

- > Kit includes Rub Rail, insert, end caps and Stainless Steel screws
- > Easy to carry retail box
- > Shipping compliant packaging

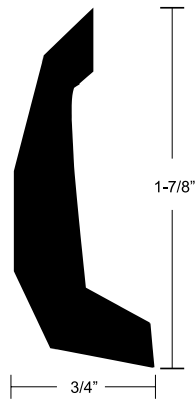

V11-4135

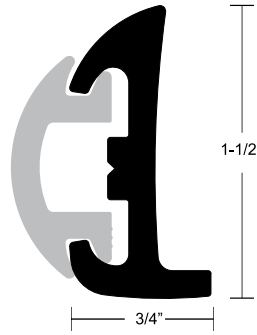

V11-9795

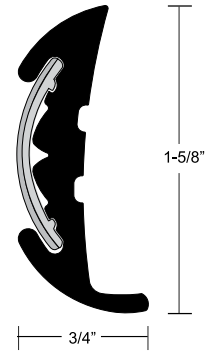

V11-9811



Part #	RR Color	Insert Color	Length	Height	Width
V11-4135BKA30-3	Black	-	30'	1-7/8"	3/4"
V11-9795BBK50D-2	Black	Black	50'	1-1/2"	3/4"
V11-9811WCM70-2	Frosty White	Chrome	70'	1-5/8"	3/4"





Flexible Vinyl Rub Rail Kit

- > Kit includes Rub Rail, insert, end caps and Stainless Steel screws
- > Soft durometer Rub Rail provides cushion effect to absorb impact
- > Continuous coils for seamless, one-piece installation
- > Tight radius bends require minimal heat
- > Easy to carry retail box
- > Shipping compliant packaging

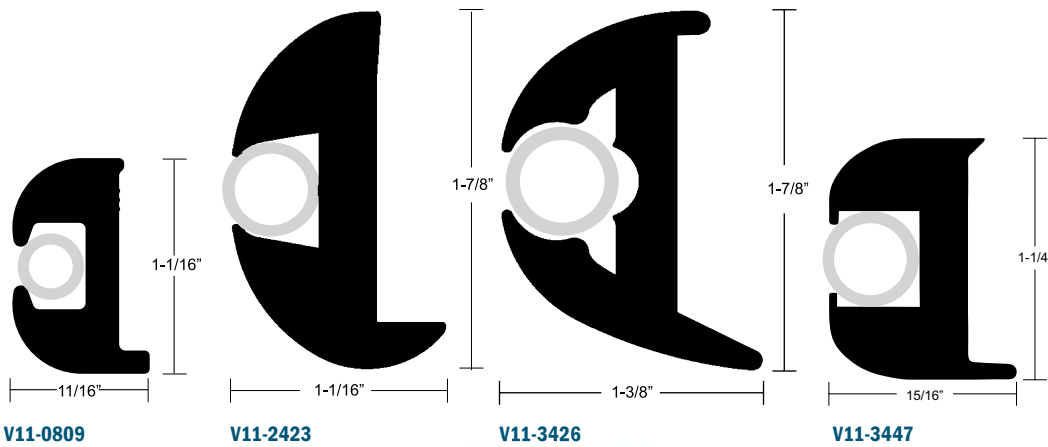

Part #	RR Color	Insert Color	Length	Height	Width
V11-0809BBK50-2	Black	Black	50'	1-1/16"	11/16"
V11-0809BBK70-2	Black	Black	70'	1-1/16"	11/16"
V11-0809BWK50-2	Black	Arctic White	50'	1-1/16"	11/16"
V11-2423BBK50-2	Black	Black	50'	1-7/8"	1-1/16"
V11-2423BBK70-2	Black	Black	70'	1-7/8"	1-1/16"
V11-2423BWK50-2	Black	Arctic White	50'	1-7/8"	1-1/16"
V11-2423BWK70-2	Black	Arctic White	70'	1-7/8"	1-1/16"
V11-3426BBK50-2	Black	Black	50'	1-7/8"	1-3/8"
V11-3426BBK70-2	Black	Black	70'	1-7/8"	1-3/8"
V11-3426BWK50-2	Black	Arctic White	50'	1-7/8"	1-3/8"
V11-3426BWK70-2	Black	Arctic White	70'	1-7/8"	1-3/8"
V11-3447BBK50-2	Black	Black	50'	1-1/4"	15/16"
V11-3447BBK70-2	Black	Black	70'	1-1/4"	15/16"
V11-3447BWK50-2	Black	Arctic White	50'	1-1/4"	15/16"
V11-3447BWK70-2	Black	Arctic White	70'	1-1/4"	15/16"
V11-3447WWK50-2	Arctic White	Arctic White	50'	1-1/4"	15/16"



ALUMINUM RUB RAIL

Aluminum Rub Rail Accepts Flexible Vinyl Insert

- > Drilled and countersunk on 6" centers
- > End caps available for select Rub Rails
- > Ideal for boats up to 24'

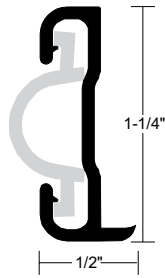

A11-0317

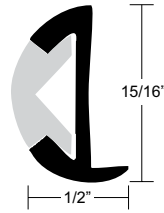

A11-0342

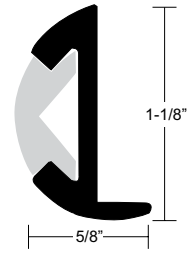

A11-0347

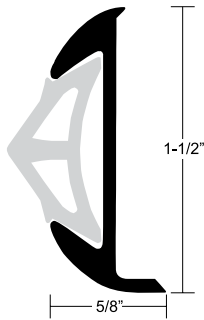

A11-0638

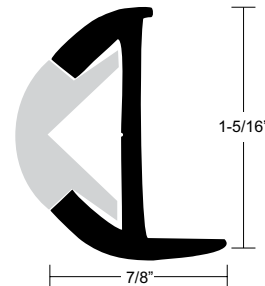

A12-0303

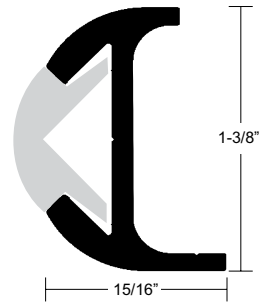

A12-0305

Part #	Finish	Length	Height	Width	Screw	Insert
A11-0317TAL12D	Polished Clear Anodized	12'	1-1/4"	1/2"	#8	V12-0317
A11-0342BLY12D	Brite Anodized	12'	15/16"	1/2"	#8	V12-0342
A11-0347BLY12D	Brite Anodized	12'	1-1/8"	5/8"	#8	V12-4155
A11-0638TAL12D	Polished Clear Anodized	12'	1-1/2"	5/8"	#8	V12-0338
A12-0303BLY12D	Brite Anodized	12'	1-5/16"	7/8"	#10	V12-0303
A12-0305BLY12D	Brite Anodized	12'	1-3/8"	15/16"	#10	V12-0303





Aluminum Rub Rail Accepts No Insert

- > Drilled and countersunk on 6" centers
- > Polished and clear anodized finish
- > Ideal for boats up to 30'

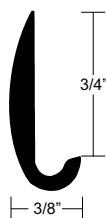

A11-0151



A11-0152

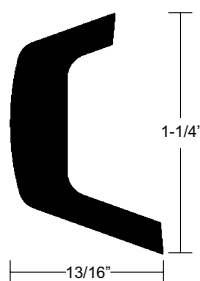

A11-0511

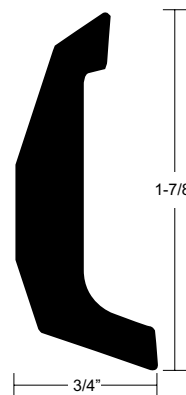

A11-0514



A50-0195



A50-0197

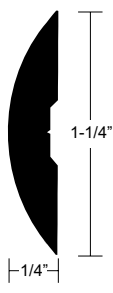

A50-0199

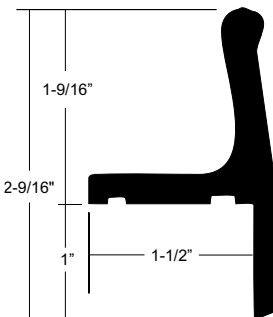

A62-0009

PRODUCT KNOWLEDGE



“Sailboat Toe Rail” mounts along the edge of deck to attach lines and hardware with 1-1/4" x 5/8" slots for attachments and slot spacing on 10" centers.

Part #	Finish	Length	Height	Width	Screw
A11-0151TAL12D	Polished Clear Anodized	12'	3/4"	3/8"	#8
A11-0152TAL12D-A	Polished Clear Anodized	12'	1"	7/16"	#8
A11-0511TAL20D	Polished Clear Anodized	20'	1-1/4"	13/16"	#10
A11-0514TAL20D	Polished Clear Anodized	20'	1-7/8"	3/4"	#10
A50-0195TAL12D	Polished Clear Anodized	12'	3/4"	3/16"	#5
A50-0197TAL12D	Polished Clear Anodized	12'	1"	3/16"	#6
A50-0199TAL12D1	Polished Clear Anodized	12'	1-1/4"	1/4"	#6
A62-0009VEL21D	Polished Clear Anodized	20'-10-3/4"	1-9/16"	1-1/2"	1/4"▶

▶ Drilled and countersunk on 4" centers



CUSTOM PRE-FORMED RUB RAIL

Custom Pre-Formed Rub Rail Accepts Stainless Steel Insert

- > Eliminates heating and hand forming pieces at corners for improved appearance to Rub Rail
- > Reduces labor associated with installation of complex Rub Rail and metal insert shapes
- > Provides a matched continuous flow to Rub Rail and insert installation
- > Many profiles available as Pre-Form capable without distortion of profile
- > Stainless Steel insert is formed to Rub Rail Pre-Form, yet cut to transition effectively for joining



PRODUCT KNOWLEDGE

IM



Pre-Formed Rub Rail for bow and transom sections of a boat offer professional finished look and is easy to install.



EASY 4-STEP QUOTATION PROCESS

- 1. 2D drawings submitted by boat builder**
- 2. Taco Marine provides quote**
- 3. Quote approval initiates splashes to be made and supplied to Taco Marine**
- 4. Taco Marine delivers ready-to-install Pre-Formed parts**



TACO
MARINE



Hollow Back Insert

Stainless Steel

Polished Mirror Finish

- > Can be used as an overlay
- > Concave back design fits rigid Vinyl Rub Rail
- > Drilled and countersunk on 6" centers

Solid Back Insert

Stainless Steel

Polished Mirror Finish

- > Can be used as an overlay
- > Drilled and countersunk on 6" centers



Hollow Back



Solid Back



Ideal for chafe protection...



Taco Marine's Hollow and Solid Back Stainless Steel Rub Rail inserts can also be used as chafe protection for your boat.

Part #	Length	Width	Thick	Screw	Gauge	Radius	Rail End
Hollow Back Stainless Steel Type 304							
S11-4500P12	12'	1/2"	-	#6	.062"	.264"	-
S11-4511P12	12'	3/4"	-	#8	.062"	.375"	S11-2000P12
S11-4511P16	16'	3/4"	-	#8	.062"	.375"	S11-2000P12
S11-4511P20	20'	3/4"	-	#8	.062"	.375"	S11-2000P12
S11-4650P12	12'	1"	-	#10	.077"	.673"	S11-2001P12
S11-4670P12[▼]	12'	1-1/4"	-	#10	.077"	.875"	-
S11-4690P12	12'	1-1/2"	-	#10	.077"	1.050"	-
Hollow Back Stainless Steel Type 316							
S11-4511P16B	16'	3/4"	-	#8	.062"	.375"	S11-2000P12
S11-4650P16B	16'	1"	-	#10	.077"	.673"	S11-2001P12
Solid Back Stainless Steel Type 304							
S11-450SP12	12'	1/2"	5/32"	#6	-	-	-
Solid Back Stainless Steel Type 316							
S11-451SP12B	12'	3/4"	3/16"	#10	-	-	-
S11-465SP20B	20'	1"	1/4"	#12	-	-	-
S11-467SP20B	20'	1-1/4"	1/4"	#12	-	-	-
S11-469SP20B	20'	1-1/2"	3/8"	#12	-	-	-

[▼]Ideal for Rub Rail insert replacement or as a chafe rail insert



VINYL INSERT

Flexible Vinyl Insert

- > Easy to handle
- > Continuous coil for seamless, one-piece installation



V12-0810



V12-0003

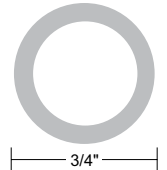

V12-0005



V12-0317



V12-0338

Part #	Retail #	Color	Length	Height	Width	Dia.	Rub Rail
V12-0003BKA250	-	Black	250'	-	-	1/2"	V11-2423, V11-3447, V11-4014
-	V12-0003BKA50-1	Black	50'	-	-	1/2"	V11-2423, V11-3447, V11-4014
-	V12-0003BKA70-1	Black	70'	-	-	1/2"	V11-2423, V11-3447, V11-4014
-	V12-0003WHA50-1	Arctic White	50'	-	-	1/2"	V11-2423, V11-3447, V11-4014
-	V12-0003WHA70-1	Arctic White	70'	-	-	1/2"	V11-2423, V11-3447, V11-4014
-	V12-0005BKA50-1	Black	50'	-	-	3/4"	V11-0899, V11-3426
-	V12-0005BKA70-1	Black	70'	-	-	3/4"	V11-0899, V11-3426
-	V12-0317BKA50-1	Black	50'	15/16"	3/8"	-	A11-0317
-	V12-0317WHA50-1	Arctic White	50'	15/16"	3/8"	-	A11-0317
V12-0338BKA200	-	Black	200'	1"	1/2"	-	A11-0638
-	V12-0338BKA50-1	Black	50'	1"	1/2"	-	A11-0638
-	V12-0338BKA70-1	Black	70'	1"	1/2"	-	A11-0638
-	V12-0810BKA50-1	Black	50'	-	-	3/8"	V11-0809
-	V12-0810WHA100-1	Arctic White	100'	-	-	3/8"	V11-0809





Flexible Vinyl Insert

- > Easy to handle
- > Continuous coil for seamless, one-piece installation

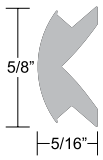

V12-0342

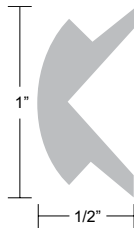

V12-0303

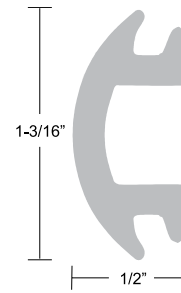

V12-4144

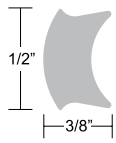

V12-9814

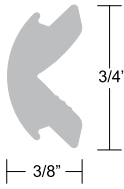

V12-4155

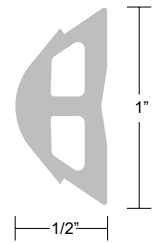

V12-9787

Part #	Retail #	Color	Length	Height	Width	Rub Rail
V12-0303BKA200	-	Black	200'	1"	1/2"	A12-0303, A12-0305
-	V12-0303BKA50-1	Black	50'	1"	1/2"	A12-0303, A12-0305
-	V12-0303BKA70-1	Black	70'	1"	1/2"	A12-0303, A12-0305
V12-0303WHA300	-	Arctic White	300'	1"	1/2"	A12-0303, A12-0305
-	V12-0303WHA50-1	Arctic White	50'	1"	1/2"	A12-0303, A12-0305
-	V12-0303WHA70-1	Arctic White	70'	1"	1/2"	A12-0303, A12-0305
V12-0303WHC200	-	Frosty White	200'	1"	1/2"	A12-0303, A12-0305
-	V12-0303WHC50-1	Frosty White	50'	1"	1/2"	A12-0303, A12-0305
-	V12-0303WHC70-1	Frosty White	70'	1"	1/2"	A12-0303, A12-0305
V12-0342BKA250	-	Black	250'	5/8"	5/16"	A11-0342
-	V12-0342BKA50-1	Black	50'	5/8"	5/16"	A11-0342
V12-4144BKA250	-	Black	250'	1-3/16"	1/2"	V21-9678
-	V12-4144BKA50-1	Black	50'	1-3/16"	1/2"	V21-9678
-	V12-4144BKA70-1	Black	70'	1-3/16"	1/2"	V21-9678
-	V12-4144WHA70-1	Arctic White	70'	1-3/16"	1/2"	V21-9678
-	V12-4155BKA50-1	Black	50'	3/4"	3/8"	A11-0347
V12-9787BKA250	-	Black	250'	1"	1/2"	A11-0347
V12-9814BKA250	-	Black	250'	1/2"	3/8"	S11-1950



VINYL INSERT

Flex Chrome Insert

- > Soft durometer provides cushion effect to absorb impact
- > Extremely durable
- > Stainless Steel appearance with approximate 30% cost savings
- > Quickly and easily install without fasteners
- > Continuous coil for one-piece installation without seams
- > Non-corrosive



FEATURE PRODUCT

V12-0307

V12-1069

V12-9809

Patent #6,349,662

PRODUCT KNOWLEDGE

Patented, flexible Vinyl Flex Chrome insert provides the beauty of Stainless Steel without the high cost and labor. Developed originally for OEM automotive exterior trim applications, "Flex Chrome" by Taco Marine has passed extensive testing for heat/humidity freeze cycle, salt spray, shock and accelerated weathering. Flex Chrome Insert is available for the following Rub Rail: V21-9501, V21-9517, V21-9662 and V21-9909 located on page RR61 and RR65.

Part #	Retail #	Length	Height	Width	Rub Rail
V12-0307CP200	-	200'	3/4"	1/2"	V21-9501, V21-9517
V12-1069CP165	-	165'	5/8"	5/16"	V21-9662
-	V12-9809CP70-1	70'	1"	1/4"	V21-9811
V12-9809CP210	-	210'	1"	1/4"	V21-9811



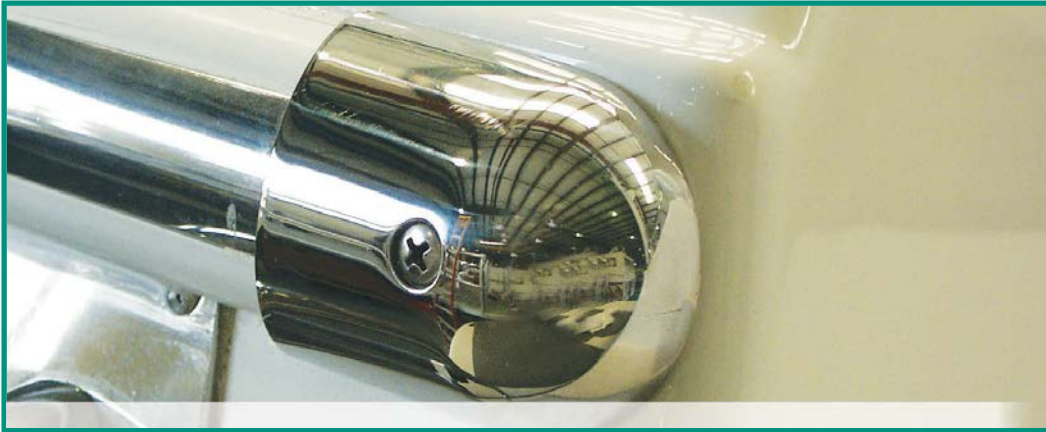

End Cap

Stainless Steel Type 316 / Nylon

- > Caps Rub Rail to finish end of rail and ensures insert stays intact

Stiffener

Aluminum

- > Ideal for V11-4014 Rub Rail with V12-0003 Insert
- > Helps keep Rub Rail straight
- > Inserts into other Flexible Vinyl Rub Rail
- > Supports fasteners for smooth installation
- > Drilled and countersunk on 6" centers



F16-0039

F16-0091

F90-0001

F90-0002

F90-0750

F90-1870

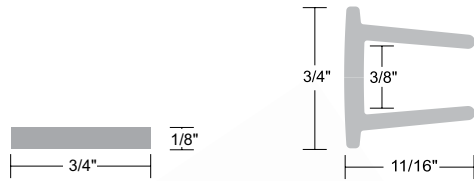

A40-0812

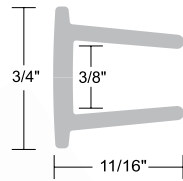

V22-3162

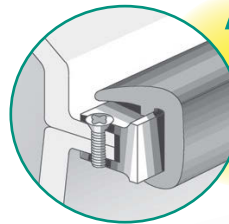

"Sandwich-Style" insert is used with V11-3161 Rub Rail to cap over deck and hull joint and is typically used on sailboats.

Rigid Vinyl Insert

Sandwich-Style

- > Easy to handle
- > Typically used on sailboats

Rub Strake

Stainless Steel Type 304

- > Designed to prevent chafing of dock, fender and anchor lines
- > Recommended for yachts and larger boats with heavy lines
- > Ideal chafe protection with or without use of extruded Rub Rail



Rub Strake



Rail End

Part #	Retail #	Color/Finish	Length	Height	Width	Screw	Rub Rail
End Caps							
F16-0039	-	Polished	2-19/64"	25/32"	1-7/8"	#8	V21-1039, V21-9647, V21-9659, V21-9662, V21-9811, V21-9866
F16-0091	-	Polished	2-7/8"	1-5/32"	2-19/64"	#8	V21-9502
F90-0001BKN	F90-0001BKN-1 [▲]	Black	-	-	2"	#8	V11-2423, V11-3426
F90-0002BKN	F90-0002BKN-1 [▲]	Black	-	-	1-9/16"	#8	V11-3447, V21-9659
F90-0750BN	F90-0750BN-1 [▲]	Black	-	-	1"	#4	A11-0342, V11-0809
F90-1870BKA	-	Black	-	-	1-3/8"	#8	A12-0303, A12-0305, V11-3447
Stiffener							
A40-0812AEY10D2	-	Mill	10'	1/8"	3/4"	#10	V11-4014
Rigid Vinyl Insert							
V22-3162BKA12	-	Black	12'	3/4"	11/16"	-	V11-3161
Rub Strakes							
S11-1700P8	-	Polished	8"	-	3/4"	#8	-
S11-1700P12	-	Polished	12"	-	3/4"	#8	-
S11-1700P18	-	Polished	18"	-	3/4"	#8	-
S11-1700P24	-	Polished	24"	-	3/4"	#8	-
S11-1800P12	-	Polished	12"	-	1"	#10	-
S11-1800P18	-	Polished	18"	-	1"	#10	-
S11-1800P24	-	Polished	24"	-	1"	#10	-
Rail Ends							
S11-2000P12	-	Polished	12"	-	3/4"	#8	-
S11-2001P12	-	Polished	12"	-	1"	#10	-

[▲]Sold in pairs

Rail End

Stainless Steel Type 304

- > Creates a finished appearance to Stainless Steel Rub Rail
- > Ideal chafe protection with or without use of extruded Rub Rail



TRIM & MOULDING





Hatch Tape



Weather Seal

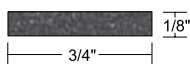

V30-0744



V30-0748

PRODUCT KNOWLEDGE



Hatch Tape is self-adhesive for convenient installation.

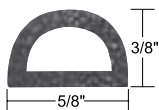
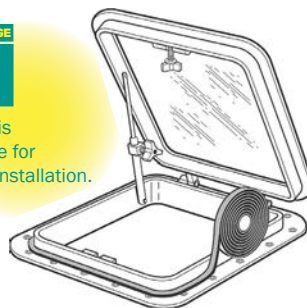

V30-0109

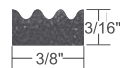

V30-0113

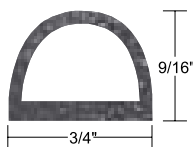

V30-0135

PRODUCT KNOWLEDGE



Weather Seal has excellent resistance to water absorption and shock and vibration.

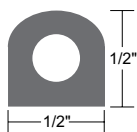

V30-0202

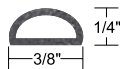

V30-1333

Part #	Retail #	Length	Height	Width
Hatch Tape				
V30-0744B8-2	-	8'	1/8"	3/4"
V30-0748B8-2	-	8'	1/4"	3/4"
Weather Seal				
V30-0109B500	-	500'	3/8"	5/8"
-	V30-0109B10-1	10'	3/8"	5/8"
V30-0113B500	-	500'	3/16"	3/8"
-	V30-0113B10-1	10'	3/16"	3/8"
V30-0135T250	-	250'	9/16"	3/4"
-	V30-0202B10-1	10'	1/2"	1/2"
-	V30-1333B10-1	10'	1/4"	3/8"



RIGID VINYL MOULDING

Angle Moulding

PVC Compound

- > UV-resistant
- > Tough, durable and long-lasting
- > Increase structural integrity
- > Cuts and drills like wood
- > Ideal for cabin doors and inside deck combing

Edge Moulding

PVC Compound

- > UV-resistant
- > Ideal for exposed areas
- > Protects and finishes edges
- > Interior and exterior usage



Awning Track



V25-9124

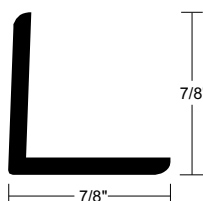

V25-0240

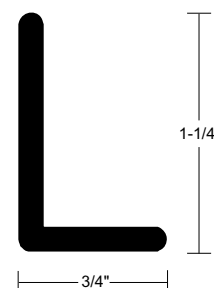

V25-9519



V25-0786



V25-0474

Part #	Length	Height	Width	Color
Angle Moulding				
V25-0240BKA12	12'	7/8"	7/8"	Black
V25-0240CRA15	15'	7/8"	7/8"	Buff
V25-0240WHA12	12'	7/8"	7/8"	Arctic White
V25-9124BKA14D	14'	9/16"	1/4"	Black
V25-9519WHA10	10'	1-1/4"	3/4"	Arctic White
Edge Moulding				
V25-0474BKA20	20'	1-1/8"	3/8"	Black
V25-0474WHA20	20'	1-1/8"	3/8"	Arctic White
V25-0786BKA12	12'	13/16"	5/16"	Black





U-Channel

U-Channel

PVC Compound

- > Covers the edge of 1/4" material
- > Soft durometer for cushion to absorb impact
- > Continuous coil for one-piece installation
- > Tight radius bending without heating

Flexible Vinyl

PVC Compound

- > Flexible PVC
- > Covers unfinished edges and follows almost any contour or radius

Flex Trim

PVC Compound

- > Flexible PVC
- > Covers unfinished edges and follows almost any contour or radius
- > Integrated interior Aluminum clip and gripping tongue ensures a better fit
- > Gripping tongue extends 7/64"
- > Available in Black or White

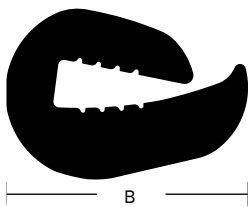

V15-5587 U-Channel



U-Channel comes in a continuous coil for one-piece installation.



V15-9779 Flexible Vinyl

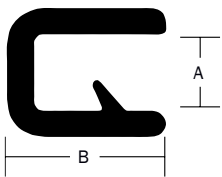

Flex Trim



Cross section of Flex Trim shows interior Aluminum clip.

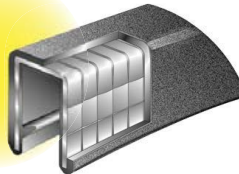

Part #	Retail #	Length	"A"*	"B"	Color
U Channel					
V15-5587WHC200	-	200'	7/8"	1-1/4"	Frosty White
Flexible Vinyl					
V15-9779WHC50	-	50'	1"	5/32"	Frosty White
Flex Trim					
V30-1005B250	-	250'	5/32"	9/16"	Black
-	V30-1005B25-1	25'	5/32"	9/16"	Black
V30-1005W250	-	250'	5/32"	9/16"	White
-	V30-1005W25-1	25'	5/32"	9/16"	White
V30-1008B250	-	250'	1/4"	1/2"	Black
-	V30-1008B25-1	25'	1/4"	1/2"	Black
V30-1008W250	-	250'	1/4"	1/2"	White
-	V30-1008W25-1	25'	1/4"	1/2"	White
-	V30-1312B25-1	25'	3/8"	5/8"	Black
V30-1312W250	-	250'	3/8"	5/8"	White
-	V30-1312W25-1	25'	3/8"	5/8"	White
-	V30-1316B25-1	25'	1/2"	19/32"	Black
-	V30-1316W25-1	25'	1/2"	19/32"	White
V30-1350B250	-	250'	5/16"	21/32"	Black
V30-1375B250	-	250'	3/16"	23/32"	Black

*Please make selection according to column A (edge thickness)



ALUMINUM MOULDING

Half Oval

Aluminum
Polished Clear
Anodized Finish

- > Traditional anodized Aluminum edge molding and seam binders
- > Available in a variety of sizes and styles
- > Drilled and countersunk on 6" centers

Drip Moulding

Aluminum
Polished Clear
Anodized Finish

- > Drilled and countersunk on 6" centers



Aluminum Moulding

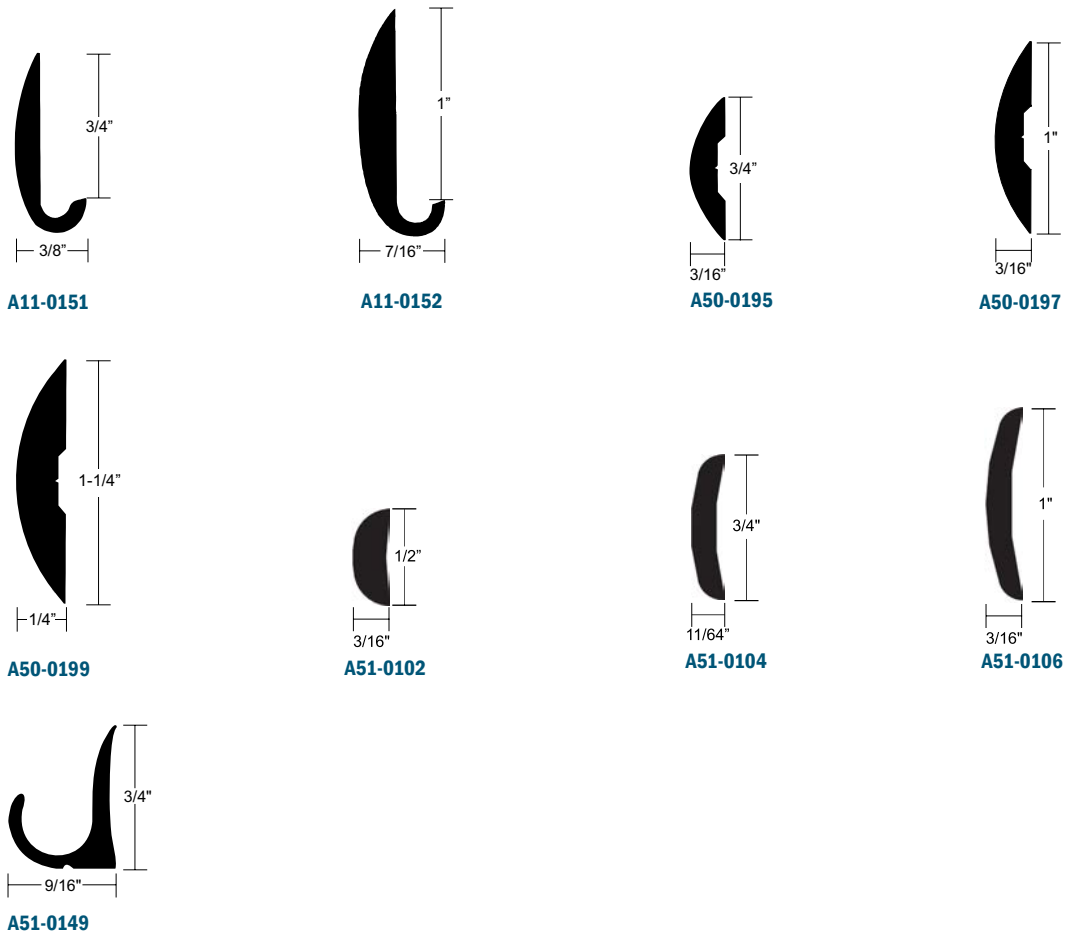

Part #	Length	Height	Width	Screw
Half Ovals				
A11-0151TAL12D	12'	3/4"	3/8"	#8
A11-0152TAL12D-A	12'	1"	7/16"	#8
A50-0195TAL12D	12'	3/4"	3/16"	#5
A50-0197TAL12D	12'	1"	3/16"	#6
A50-0199TAL12D1	12'	1-1/4"	1/4"	#6
A51-0102TAL12D	12'	1/2"	3/16"	#6
A51-0102TAL12D-1'	12'	1/2"	3/16"	#6
A51-0104TAL12D-A	12'	3/4"	11/64"	#6
A51-0106TAL12D	12'	1"	3/16"	#6
Drip Moulding				
A51-0149TAL12D	12'	3/4"	9/16"	#6

*Drilled and countersunk on 3" centers





Slide Track

Aluminum

- > Track for use on Bimini canvas tops
- > Sliding door track ideal for doors up to 7/32"

T-Hatch Trim

Aluminum

- > Ideal for hatches
- > Available in both polished clear anodized and satin anodized finish

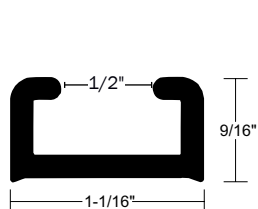

A52-0309

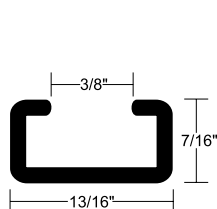

A52-0037

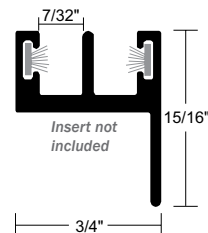

A52-0084

Part #	Description	Length	Height	Width	Opening	Finish
A52-0309BLY12	Slide Track	12'	9/16"	1-1/16"	1/2"	Brite Anodized
A52-0037BLY14	Slide Track	14'	7/16"	13/16"	3/8"	Brite Anodized
A52-0084VEL12	Sliding Door Track	12'	15/16"	3/4"	7/32"	Satin Anodized

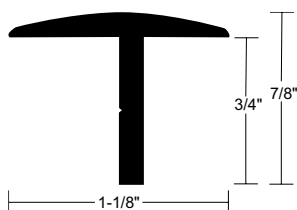

A50-0304

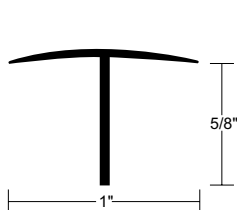

A50-0305

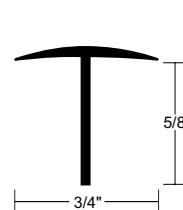

A50-0375

Part #	Description	Length	Height	Width	Finish
A50-0304TAL12	T-Hatch Trim	12'	3/4"	1-1/8"	Polished Clear Anodized
A50-0305TAL12	T-Hatch Trim	12'	5/8"	1"	Polished Clear Anodized
A50-0375VEL12	T-Hatch Trim	12'	5/8"	3/4"	Satin Anodized



ALUMINUM MOULDING

Edge Moulding

Aluminum

Polished Clear Anodized Finish

- > Lightweight for tight radius bending
- > Drilled and countersunk on 6" centers

Channel

Aluminum

Polished Clear Anodized Finish

- > Decorative channels for mounting fixed panels or partition applications

Hatch Trim

Stainless Steel Type 304
Polished Finish

- > Provides a finished look to hatches and doors
- > Mirror finish creates elegant look where applied



Aluminum Moulding

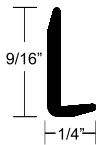

A50-0272

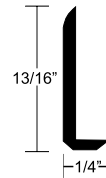

A50-0275

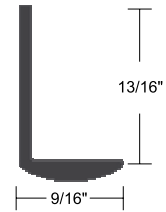

A50-0326

Part #	Length	Height	Width	Thick	Screw
A50-0272TAL12D	12'	9/16"	1/4"	1/16"	#6
A50-0275TAL12D	12'	13/16"	1/4"	1/16"	#5
A50-0326TAL12D*	12'	13/16"	9/16"	1/16"	#5

*Ideal for transoms

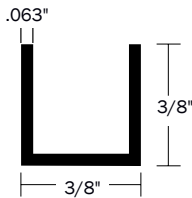

A50-0235

Part #	Length	Height	Width	Gauge
A50-0235TAL12	12'	3/8"	3/8"	.063"

Stainless Steel Moulding



S11-4680

Retail #	Length	Width	Gauge	Screw	Finish
S11-4680P6-1	6'	1-1/2"	.062"	#6FH	Polished





Hull Stiffener

Hull Stiffener

Polystyrene

- > Improves hull strength and rigidity with little additional weight
- > High impact polystyrene material easily bonds with fiberglass
- > Can also be used as a wire chase

Wire Chase

Rigid Vinyl

- > Snaplock feature for wire management
- > Offset to adapt to contour of hull
- > Variety of mounting options

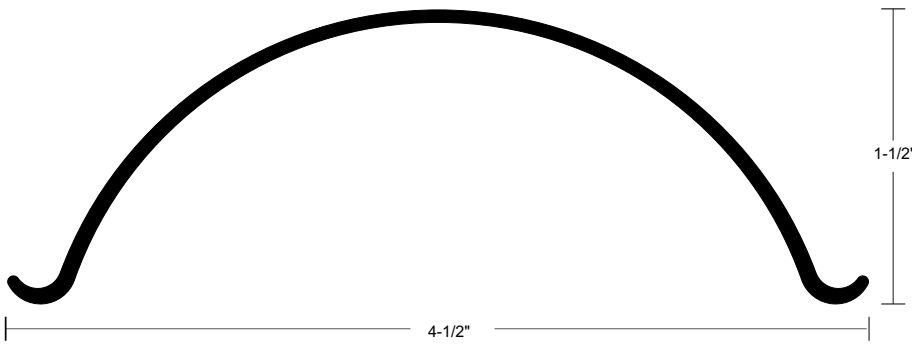

V25-9543

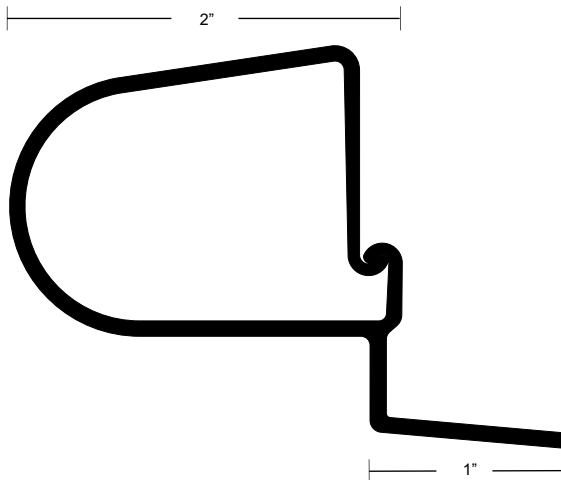

V25-9753



Wire Chase is ideal for running wires under deck.

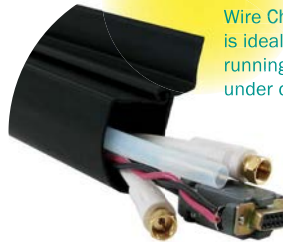

Part #	Description	Length	Height	Width	Color
V25-9543NAT10∞	Hull Stiffener	10'	1-1/2"	4-1/2"	Natural
V25-9753BKA10∞	Wire Chase	10'	1-3/8"	2"	Black

∞Special Order



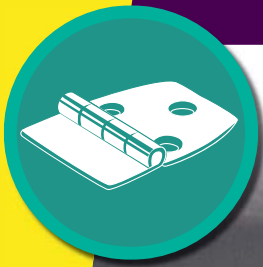

HINGES & LATCHES

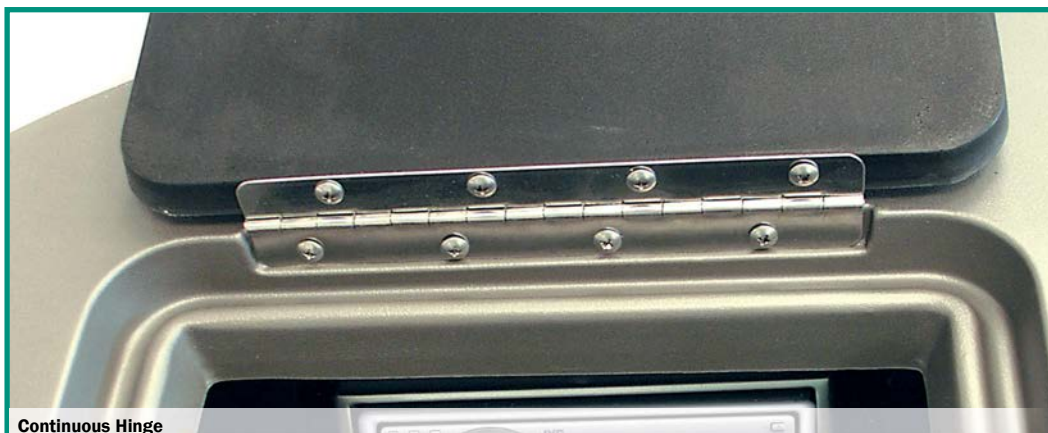

Continuous Hinge

Continuous Hinge

Stainless Steel Type 304

Bright Annealed Finish

> 1/2" knuckle length

Polished Finish

> 1/2" knuckle length

> Drilled on 2" centers

Aluminum

Mill Finish

> 1/2" knuckle length

> Drilled on 4" centers

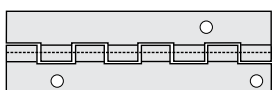

Style A:

Holes are drilled on 4" centers with 1/2" stagger

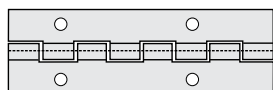

Style E:

Holes are drilled on 2" centers with no stagger

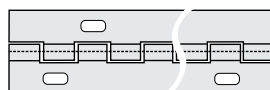

Style G:

Slots are drilled and countersunk on 6" centers with 1" stagger

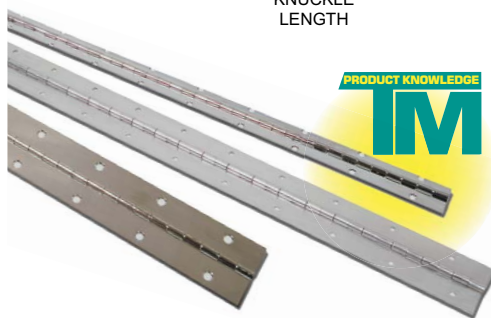
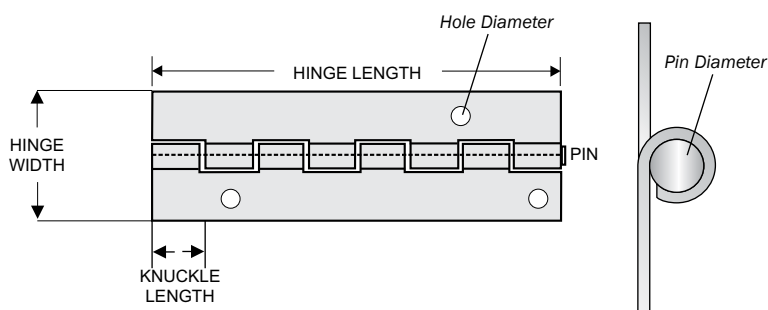

Continuous Hinges "Piano Hinges" are...

- Strong throughout entire length because each knuckle is a load bearing point
- Increase product rigidity by supporting full length of the application
- Easier and more precise to align than two or more butt hinges
- Attractive and uniform in appearance
- Smooth in pivotal action, providing optional axial rotation
- Low-cost and economical
- Available in many variations and are customizable

Part #	Retail #	Length	Width	Gauge	Pin Dia.	Hole Dia.	Screw	Style
Stainless Steel Bright Annealed Finish								
H14-0112A72	H14-0112A72-1	72"	1-1/2"	.040"	.091"	.235"	#6	E
H14-0114A72	H14-0114A72-1	72"	1-1/4"	.040"	.091"	.215"	#5	E
H14-0116A72	H14-0116A72-1	72"	1-1/16"	.040"	.091"	.215"	#5	E
H14-0200A72	H14-0200A72-1	72"	2"	.040"	.091"	.211"	#6	E
H14-0300D96A	-	96"	3"	.070"	.25"	.281"x.562"	#6	G
Stainless Steel Polished Finish								
H14-0112P72	-	72"	1-1/2"	.040"	.091"	.235"	#6	E
H14-0114P72	-	72"	1-1/4"	.040"	.091"	.215"	#5	E
H14-0116P72	-	72"	1-1/16"	.040"	.091"	.215"	#5	E
H14-0200P72	-	72"	2"	.040"	.091"	.211"	#6	E
Aluminum Mill Finish								
-	H11-1126D72-1	72"	1-1/2"	.060"	.118"	.188"	#5	A
-	H11-1144D72-1	72"	1-1/4"	.040"	.091"	.188"	#5	A
-	H11-2006D72-1	72"	2"	.060"	.118"	.188"	#5	A



DECK HINGES

Standard

Butt Hinge

Stamped Stainless Steel Type 304
Electro Polished Finish

> Available in both Standard and Deluxe hinge design

Strap Hinge

Stamped Stainless Steel Type 304
Electro Polished Finish

> Available in both Standard and Classic hinge design

Hatch Hinge

Stamped Stainless Steel Type 304
Electro Polished Finish

> Available in Standard, Deluxe and Classic hinge design



Deck Hinge



H20-0112 • H20-0200

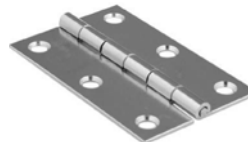

H20-0230

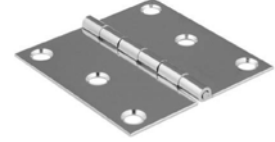

H20-0300



H21-0132



H21-0133



H21-0434



H21-0600



H21-0632



H21-0232



H21-0234

Part #	Pin Length	Open Width	Offset	Gauge	Screw
Butt Hinge					
H20-0112	2"	1-1/2"	-	.060"	#8
H20-0200	2"	2"	-	.060"	#8
H20-0230	3"	2"	-	.060"	#8
H20-0300	3"	3"	-	.060"	#10
H21-0132	1-1/2"	1-5/16"	-	.060"	#8
H21-0133	1-1/2"	15/16"	3/8"	.060"	#8
Strap Hinge					
H21-0434	1-1/16"	3-15/16"	-	.060"	#8
H21-0600	1-1/2"	6"	-	.060"	#8
H21-0632	1-1/2"	4-5/16"	-	.060"	#8
Hatch Hinge					
H21-0232	1-1/2"	2"	-	.060"	#8
H21-0234	1-1/2"	2-3/4"	-	.060"	#8





Deck Hinge

Deluxe/Classic

Butt Hinge

Stamped Stainless Steel Type 304

Electro Polished Finish

- > Available in both Standard and Deluxe hinge design

Strap Hinge

Cast Stainless Steel Type 316

Deluxe Polished Finish

- > Available in both Standard and Classic hinge design
- > Sold in Pairs

Hatch Hinge

Cast Stainless Steel Type 316

Deluxe Polished Finish

- > Available in Standard, Deluxe and Classic hinge design
- > Sold in Pairs



H22-1550



H30-1010



H23-0092



H23-0157



H23-1490



H23-1499 (Reverse Pin)



H23-4000



H30-1050



H30-1070

Part #	Pin Length	Open Width	Gauge	Screw
Butt Hinge Deluxe				
H22-1550	1-1/2"	2-1/4"	.078"	#8
Strap Hinge Classic				
H30-1010	1"	4"	.125"	#10
Hatch Hinge Deluxe				
H23-0092	3"	3"	.078"	#12
H23-0157	1-9/16"	2-3/4"	.078"	#10
H23-1490	1-1/2"	3"	.078"	#10
H23-1499	1-1/2"	3"	.078"	#10
H23-4000	1-1/2"	3-3/4"	.098"	#10
Hatch Hinge Classic				
H30-1050	1-1/2"	3"	.125"	#10
H30-1070	1-1/2"	2-1/4"	.125"	#10



HINGES & LATCHES

SPECIALTY HINGES

Command Ratchet Hinge

**Cast Stainless Steel
Type 316**

High Polished Finish

- > Meets ABYC H-31 Standards Class B* application, 250lb ft of torque load for pair
- > Designed for up to 4" cushion thickness
- > Seatback up to 28" W and 14" H
- > 15° locking inclination and ratchet up 4 positions
- > Returns to horizontal position at 100°
- > All Brass bearings for durability
- > Countersunk for 1/4" bolt and #10 fasteners
- > Sold in Pairs



Command Ratchet Hinge



Patent #9,249,827



PRODUCT KNOWLEDGE
TM

The Command Hinge is ideal for sunpads, bolsters and lounge backrests.

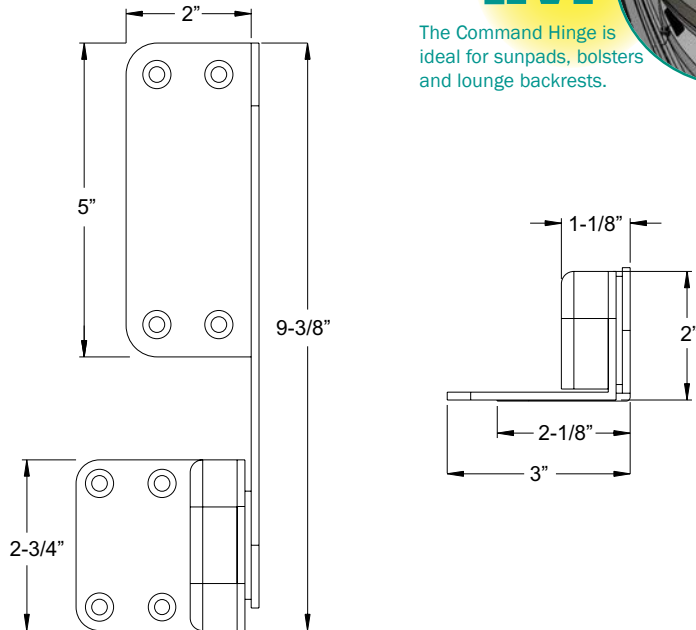
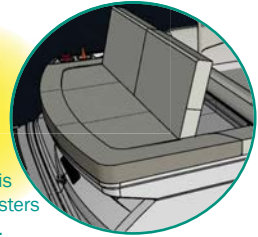

* ABYC H-31 Standards Class B is a seat designed for occupancy only at boat speeds not exceeding five miles per hour



Part #	Description	Length	Width	Gauge	Screw
H25-0016	Command Ratchet Hinge	9-3/8"	3"	.10"	#10 or 1/4" bolt



Intelli-Hinge

Intelli-Hinge

**Cast Stainless Steel
Type 316**

- > Integrated ball and socket pivot point allows pivoting on concave, convex and multiple-plane surfaces
- > Offers 20° range of motion
- > Hinges from any two sides, unlike conventional fixed-axis hinges
- > Low-profile Euro styling enhances the look of any boat
- > Polished Stainless Steel Type 316 and Delrin insert prevent corrosion, galling and eliminates rattling



Patent #7,921,513



H90-0400



The Intelli-Hinge permits hinging concave surfaces where conventional hinges are unable to perform.

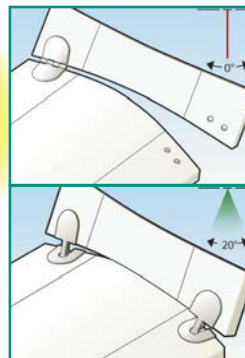

Hasp Hinge

**Stainless Steel Type 316
Deluxe Polished Finish**

- > Traditional style swivel lock secures latch
- > Concealed fastener for security
- > Allows for addition of lock
- > Over-sized hinge pins for added security



H30-1015



H30-1044 / H30-1045

Hidden Fastener

**Stainless Steel Type 316
Deluxe Polished Finish**

- > Fasten from underside for clean, contemporary design

Part #	Description	Length	Width	Gauge	Screw
H90-0400	Intelli-Hinge	2"	4" (Open)	.10"	#8
H30-1015	Hasp Hinge	1" Pin Length	3"	.125"	#6
H30-1044∞	Hidden Fastener	1-1/2"	3"	.125"	#8
H30-1045∞	Hidden Fastener	2"	4"	.125"	#10

∞Special Order



SPECIALTY LATCHES

Sundeck Latch

Plastic & Stainless Steel Type 316

- > Low profile
- > Concealed latches
- > Non-slip grip
- > Positive locking
- > Ideal for engine hatches, access panels, dock boxes, folding seats, leaning posts, large seats



Sundeck Latch



Windshield Latch

Walk-Thru Windshield Latch

Stamped Stainless Steel Type 316

Electro Polished Finish

- > Attaches to front deck and to windshield door frame
- > Positive spring locking feature

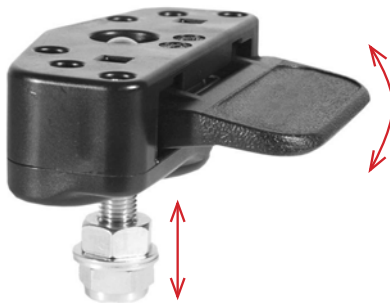

F45-0339

REPLACEMENT PART

F45-0336/F45-0339B



Part #	Description	Locking Pin Length	Color
F45-0339B	Sundeck Latch, Black	2-3/4"	Black
F45-0339W	Sundeck Latch, White	2-3/4"	White
F45-0336/0339B-3	Replacement Locking Pin, Stainless Steel	2-3/4"	-
F45-0336/0339B-4	Replacement Long Locking Pin, Stainless Steel	3-3/4"	-



F16-2900



Windshield Latch has easy opening and locking mechanism.

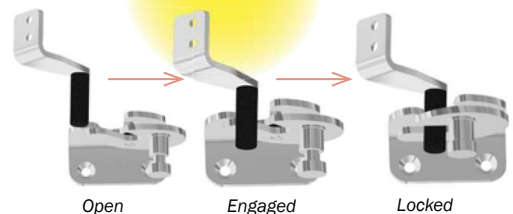

Part #	Description	Mount Area	Screw
F16-2900	Walk-Thru Windshield Latch	1" x 2" Deck Mount Area 5/8" x 1" Door Mount Area	#8





Latch-Tite Lifting Handle

Latch-tite™ Lifting Handle

Nylon & Glass Reinforced Resin

- > Fits into 2" hole
- > Variety of diameter dimensions available
- > Concealed fasteners
- > Edge thickness 1/8"

Cast Stainless Steel Type 316

Deluxe Polished Finish

- > Concealed fasteners

Lifting Ring

Stamped Stainless Steel Type 304

- > Retaining clip
- > Dampening plate

Grab Handle

Cast Stainless Steel Type 316

Deluxe Polished Finish

- > 1-5/8" clearance from deck
- > Ideal for both interiors and exteriors



F16-2500



F42-2500 (Stainless Steel handle)



F42-2500 (Nylon handle)

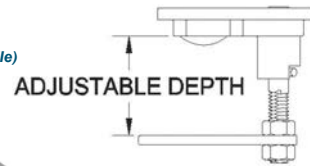

F16-3000



F16-3500



F16-2525

Part #	Dimension	Edge Thickness	Adj. Depth	Hole	Overall Depth	Screw	Color
Nylon & Glass							
F42-2500WHA	2-1/2"	1/8"	1-3/4"	2-1/16"	2-5/16"	#8	White
F42-2500BKSS	2-1/2"	1/8"	1-3/4"	2-1/16"	2-5/16"	#8	Black
Stainless Steel Type 316							
F16-2500	2-1/2"	5/32"	1-3/4"	2-1/16"	2-5/8"	#8	-
F16-3000	3"	3/32"	2-7/8"	2-9/16"	3-13/16"	#8	-
F16-3500	3-1/2"	5/32"	2-1/2"	3"	3"	#10	-
F16-2525	2-7/16" x 2-7/16"	5/32"	1-3/4"	2-1/16"	2-5/16"	#8	-



F16-0021



F16-1090

Part #	Description	Length	Height	Hole	Diameter
F16-0021	Lifting Ring	2-1/8"	-	-	1-1/4"
F16-1090	Grab Handle	6"	1-5/8"	1/4"	-





MARINE ACCESSORIES





Come On Board Handle - Rod Holder Mount



Come On Board Handle - Fixed Base Mount

Come On Board Handle

Stainless Steel Type 304

- > Finger molded handles for secure grip
- > Two-piece design for easy storage
- > Ideal for boarding platform
- > Ideal height for convenient boarding in low tide
- > Packaged in mesh bag used for drying and avoiding scratches on deck
- > Fits standard 1-5/8" Rod Holder ID

Rod Holder Mount

- Solid gimbal mount design assures proper locking placement

Fixed Base Mount

- Includes receiver with backing plate
- Attaches permanently to gunnel mount
- Come On Board Cast Stainless Steel Fixed Mount Handle Receiver only also sold separately as F16-0800C-1



F16-0800

F16-0810

Part #	Description	Height	Width	Tube OD
F16-0800-1	Come On Board Handle, Fixed Base Mount w/Receiver	56-1/4"	11-5/8"	1-1/2"
F16-0800C-1	Come On Board Fixed Base Mount Handle Receiver Only	3-1/2"	3"	1-3/4"
F16-0810-1	Come On Board Handle, Rod Holder Mount	57-1/2"	11-5/8"	1-1/2"



DOCKSIDE

Quick Release Fender Lock

Stainless Steel Type 316 Polished Finish

- > Designed for single hand operation
- > Will allow easy installation and removal of float style fenders
- > Large push-button for comfortable operation
- > Large .88 hole diameter for rope
- > Overall height above deck: 1-19/32"
- > Drain plug: 1/4" NPT
- > Quick Release Fender Lock Receiver only also sold separately as F16-0151R-1

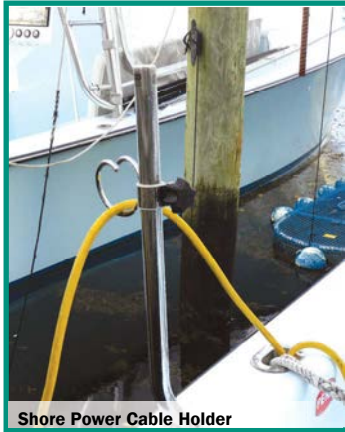

Shore Power Cable Holder



Quick Release Fender Lock

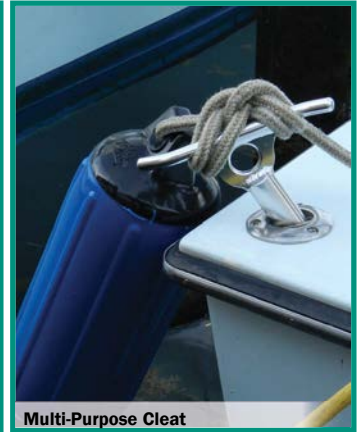

Multi-Purpose Cleet

Shore Power Cable Holder

Stainless Steel Type 304

- > Fits into standard Rod Holders at 1-5/8" diameter
- > Quick, adjustable height ring to compensate for low or high tide settings
- > Clamp-on ring can be adapted to 1-1/4" or 1-1/2" tube diameter by removing Delrin Washer
- > Accommodates 30, 50 and 100 AMP shore power cables
- > Shore Power Cable Holder Adjustable Ring only also sold separately as F16-0804-1



ALSO SOLD SEPARATELY

Adjustable Ring only, F16-0804-1



Mounts to 1-1/4" & 1-1/2" Pipe

Gimbal design for secure locking placement

F16-0802

ALSO SOLD SEPARATELY

Quick Release Fender Lock Receiver only, F16-0151R-1



7/8" Hole ID

F16-0151

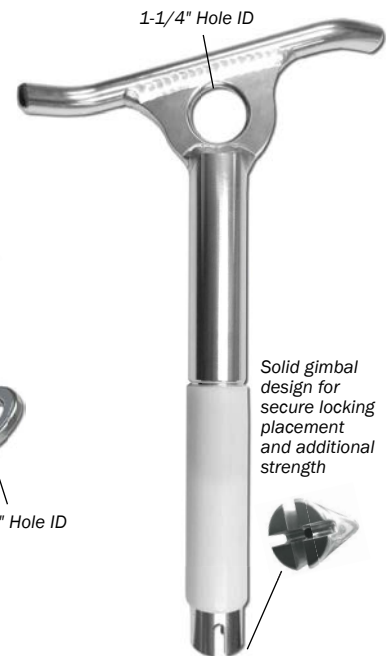

1-1/4" Hole ID

Solid gimbal design for secure locking placement and additional strength

F30-0861

Multi-Purpose 15° Portable Cleet

Aluminum Brushed Finish

- > Large S-shape 9" cleat
- > Ideal for 5/8" and 3/4" dock line for large boat applications
- > Pipe diameter 1-1/2" fits into standard Rod Holders 1-5/8" diameter
- > Loop hole design to hang fenders over the side or hanging hose while washing boat



Part #	Description	Height	Width	Tube OD
F16-0151-1	Quick Release Fender Lock	1-19/32" (above deck) 2" (below deck)	1-1/2" (knob) -	
F16-0151R-1	Quick Release Fender Lock Receiver Only	2-1/4"	2"	-
F16-0802-1	Shore Power Cable Holder w/Ring	29"	4"	1-1/2"
F16-0804-1	Shore Power Cable Holder Adjustable Ring Only	4-1/2"	8"	1-1/2"
F30-0861BSA-1	Multi-Purpose 15° Portable Cleet	14-1/2"	9"	1-1/2"



Dockside Filet Table

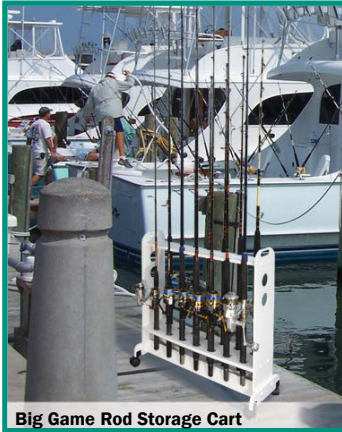

Big Game Rod Storage Cart



Trailer Glyde Slicks

Dockside Filet Table

High-Density Polyethylene

- > Brushed Aluminum legs
- > Permanently mounts to dock using continuous flat bar mounting pads
- > Water nozzle holder for convenient use and clean-up
- > Attached drink holder included
- > Filet plier and knife holder slots
- > Mounting hardware included
- > Holds up to 250lbs.

Big Game Poly Rod Storage Cart

High-Density Polyethylene

- > UV-stabilized White Polymer
- > Wash rods while in rack
- > Use indoor or outdoor
- > Locking casters offer easy mobility
- > Ideal for large spinning and conventional reels

Trailer Glyde Slicks

High-Density Polyethylene

- > Eliminates friction between the bottom of the boat and the runners
- > Easily installed on carpeted or bare bunks
- > Evenly distribute the weight of the boat
- > Includes Stainless Steel screws and instructions

Light Duty Glyde Slicks

- Ideal for boats under 600lbs.

Premium Glyde Slicks

- Ideal for boats up to 2000lbs.



P01-4821



R10-0514103

PRODUCT KNOWLEDGE



Big Game Rod Storage Cart accommodates light and medium tackle spinning, casting and conventional rods and reels.

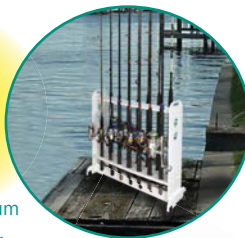

P05-06W / P05-08W

P06-06W

Part #	Description	Length	Height	Width
P01-4821W	Dockside Filet Table	48"	37"	21"
R10-0514103	14-Rod Big Game Cart	33-3/4"	33-1/4"	12"
P05-06W	6, 2' Light Duty Trailer Glyde Slicks	2'	7/16" Thick	1-5/8"
P05-08W	8, 2' Light Duty Trailer Glyde Slicks	2'	7/16" Thick	1-5/8"
P06-06W	6, 2' Premium Trailer Glyde Slicks	2'	7/16" Thick	1-1/2"



LED LIGHTS

LED Deck Light Flat Mount

Polycarbonate Housing

- > 12-24V DC
- > USCG, ISO and SAE certified for Ignition Protection*
- > Compact design bolts directly to any flat surface 5" long and 1-3/8" width
- > 8' hidden power cable
- > Wire chase guards included for running wires through tube or pipe
- > Includes Stainless Steel Type 304 swivel bracket and 3M adhesive tape for mounting options
- > High impact, UV-resistant, lightweight White or Black Polycarbonate housing
- > Durable and self-extinguishing clear plastic lens
- > Anodized Aluminum heatsink
- > LED chips are silicone potted for IP67 Waterproof (non-submersion)

4-LED Deck Light

- 10.0 Watt equivalent to a 55 Watt halogen flood light
- Powerful 700 lumen output with 100° spread beam angle
- Low power consumption (0.9 amps @ 12V, 0.5 amps @ 24V)

3-LED Deck Light

- 8.0 Watt equivalent to a 55 Watt halogen flood light
- Powerful 540 lumen output with 100° spread beam angle
- Low power consumption (0.6 amps @ 12V)
- Available in Blue or Red LED lights

*Completely sealed lights tested in explosive environment and exposed to explosive atmosphere in high temperature that includes powering on-off 50 times without igniting the atmosphere at a temperature not exceeding 200° C. Meets statutory and regulatory requirements that assure customer satisfaction and safety. Ideal for use in engine rooms, battery compartments and anywhere fire safety is of most importance.



4-LED Flat Mount Deck Light

LED Deck Light Flat Mount has Stainless Steel Type 304 swivel bracket with 60° vertical pivoting rotation.



NEW!
4-LED



F38-8800



F38-8805

NEW!
Black Housing

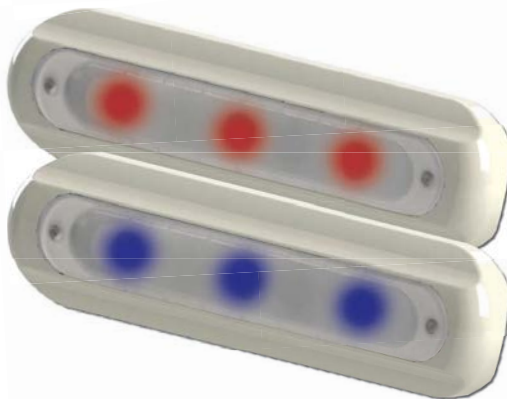

F38-8500



F38-8505

Dimensions are the same for both 3- and 4-LED lights

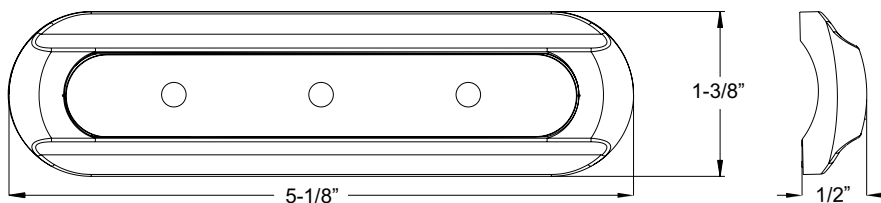

Part #	Description	Height	Width	Depth	LED Color	Lumens	Amperes Draw
F38-8805W-1	4-LED Deck Light, Black Housing	1-3/8"	5-1/8"	1/2"	White	700	.9 @ 12V
F38-8800W-1	4-LED Deck Light, White Housing	1-3/8"	5-1/8"	1/2"	White	700	.9 @ 12V
F38-8505B-1	3-LED Deck Light, Black Housing	1-3/8"	5-1/8"	1/2"	Blue	540	.6 @ 12V
F38-8505R-1	3-LED Deck Light, Black Housing	1-3/8"	5-1/8"	1/2"	Red	540	.6 @ 12V
F38-8500B-1	3-LED Deck Light, White Housing	1-3/8"	5-1/8"	1/2"	Blue	540	.6 @ 12V
F38-8500R-1	3-LED Deck Light, White Housing	1-3/8"	5-1/8"	1/2"	Red	540	.6 @ 12V



3-LED Pipe Mount Deck Light

LED Deck Light Pipe Mount

Aluminum Housing Anodized Finish

- > 12-24V DC
- > USCG, ISO and SAE certified for Ignition Protection*
- > Compact design bolts directly to 1" schedule 40 pipe
- > 8' hidden power cable
- > Wire chase guards included for running wires through tube or pipe
- > Bright dip anodized Aluminum housing can also be powder coated
- > Durable and self-extinguishing clear plastic lense
- > Anodized Aluminum heatsink
- > LED chips are silicone potted for IP67 Waterproof (non-submersion)



PRODUCT KNOWLEDGE



LED Deck Light Pipe Mount's low profile at 1/2" depth is ideal for t-tops, towers, railings, polings platforms and leaning posts.



F38-8800

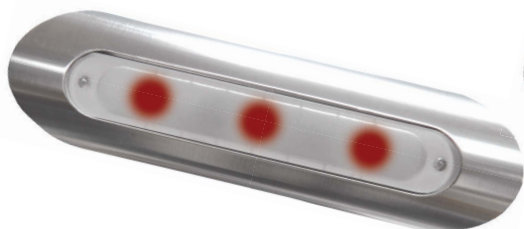

F38-8600 Series

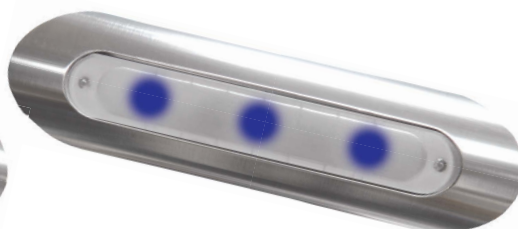

4-LED Deck Light

- 10.0 Watt equivalent to a 55 Watt halogen flood light
- Powerful 700 lumen output with 100° spread beam angle
- Low power consumption (0.9 amps @ 12V, 0.5 amps @ 24V)

3-LED Deck Light

- 8.0 Watt equivalent to a 55 Watt halogen flood light
- Powerful 540 lumen output with 100° spread beam angle
- Low power consumption (0.6 amps @ 12V)
- Available in Blue or Red LED lights

Dimensions are the same for both 3- and 4-LED lights

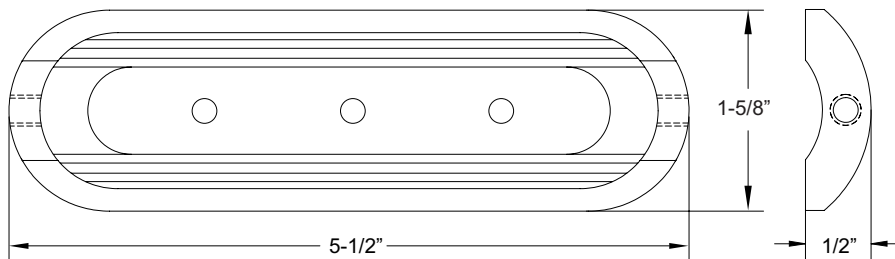

Part #	Description	Height	Width	Depth	LED Color	Lumens	Amperes Draw
F38-8800BXZ-W-1	4-LED Deck Light, White Light	1-5/8"	5-1/2"	1/2"	White	700	.9 @ 12V
F38-8600BXZ-B-1	3-LED Deck Light, Blue Light	1-5/8"	5-1/2"	1/2"	Blue	540	.6 @ 12V
F38-8600BXZ-R-1	3-LED Deck Light, Red Light	1-5/8"	5-1/2"	1/2"	Red	540	.6 @ 12V

*Completely sealed lights tested in explosive environment and exposed to explosive atmosphere in high temperature that includes powering on-off 50 times without igniting the atmosphere at a temperature not exceeding 200° C. Meets statutory and regulatory requirements that assure customer satisfaction and safety. Ideal for use in engine rooms, battery compartments and anywhere fire safety is of most importance.



LED LIGHTS

LED T-Top Light Pipe Mount

Aluminum Housing
Anodized Finish

- > 8.0 Watt per section, 24 Watt total
- > 12-24V DC
- > Compact design bolts directly to 1" IPS pipe
- > White light has powerful 1080 lumen output with 100° spread beam angle
- > Red or Blue light 540 lumen output
- > Requires On-Off-On switch for proper operation
- > Very low power consumption (1.8 amps @ 12V)
- > 14' hidden power cable
- > Able to switch from White light to Blue or to Red light
- > Bright dip anodized Aluminum housing
- > Durable and self-extinguishing clear plastic lens
- > LED chips are silicone potted for IP67 waterproof



LED T-Top Pipe Mount Light

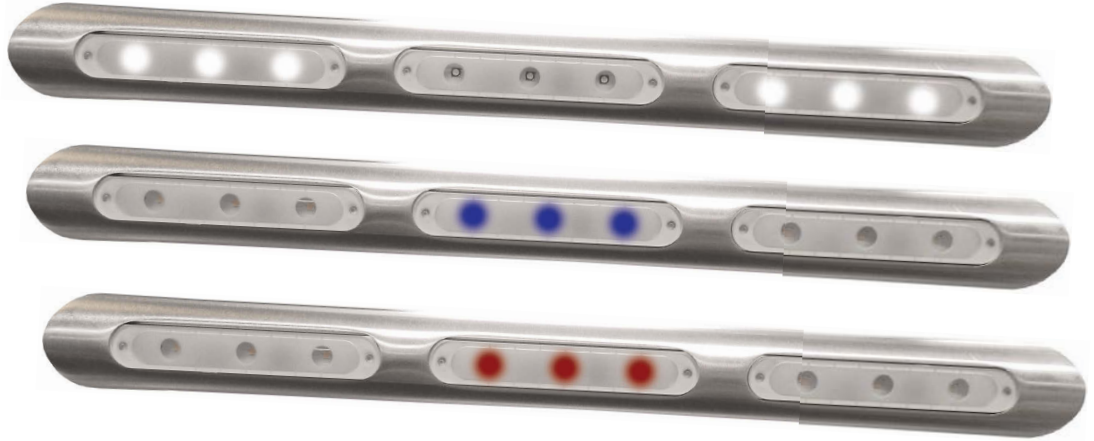

PRODUCT KNOWLEDGE
TM

LED T-top Light Pipe Mount's middle lights are off when White lights are on, when Blue or Red lights are on, side lights are off.

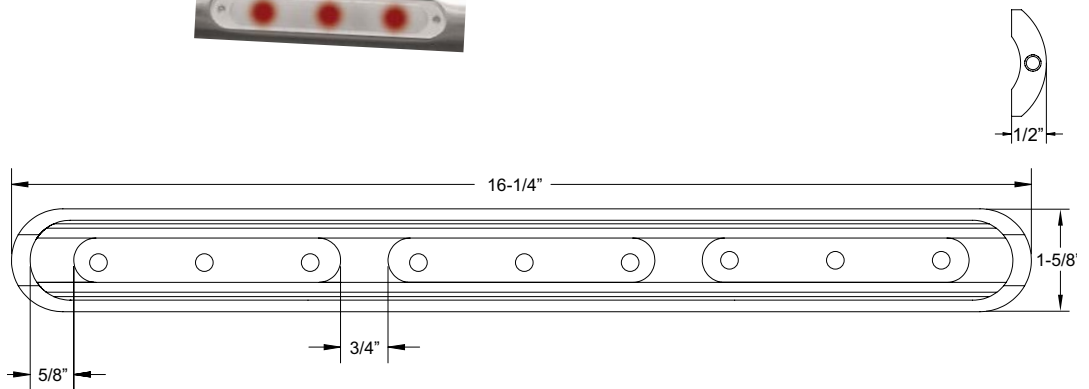
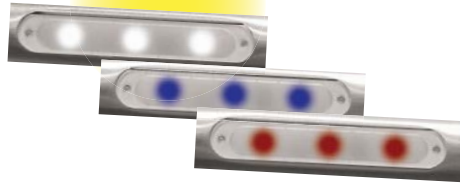

Part #	Description	Height	Width	Depth	Lumens	Amperes Draw
F38-9600BXZ-B-1	LED T-top Light, White to Blue Light	1-5/8"	16-1/4"	1/2"	540 (1080 White Light)	1.8 @ 12V
F38-9600BXZ-R-1	LED T-top Light, White to Red Light	1-5/8"	16-1/4"	1/2"	540 (1080 White Light)	1.8 @ 12V





LED T-Top Tube Light

LED T-Top Tube Light

Aluminum Housing Anodized Finish

- > 12-24V DC
- > 108 LEDs
- > 14' wiring cable
- > IP67 Waterproof (non-submersible)

T-Top Replacement Tube Light

- 12-24V DC
- 108 LEDs
- 14' wiring cable
- Includes mounting clips
- Fits most existing t-top light housing
- Switch from White to Red light or to Blue light



F38-2050

F38-2060

LED Spreader Light

- > 12-28Volt AC/DC
- > High 675 lumen output
- > Six (6) high-powered 1-Watt LEDs
- > IP67 Waterproof (non-submersible)
- > Wide 150° spread beam angle
- > Adjustable Stainless Steel mounting bracket with adjustable tilt
- > UV- and impact-resistant White housing and polycarbonate lens

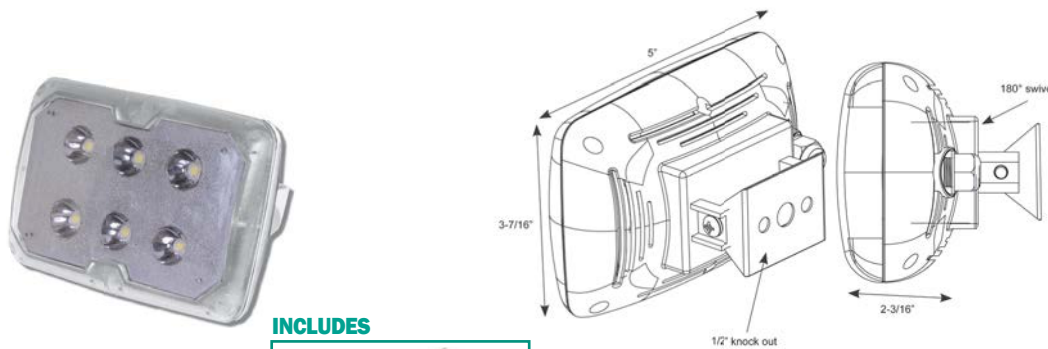
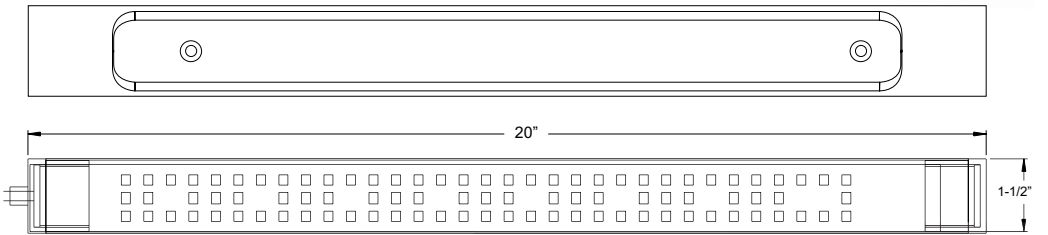

F38-4600WHA-1

INCLUDES

Clamps for Standard 3/4" - 1" IPS T-top Ring (1-1/16" & 1-5/16" OD Pipe)



Part #	Description	Height	Width	Depth	Lumens	Amperes Draw
F38-2050B-1	LED T-top Light w/Aluminum Housing, Wht/Blue	1-1/2"	20"	1-1/2"	300	.5 @ 12V
F38-2050R-1	LED T-top Light w/Aluminum Housing, Wht/Red	1-1/2"	20"	1-1/2"	300	.5 @ 12V
F38-2060B-1	LED Replacement Tube Light, Wht/Blue	1-1/2"	20"	1-1/2"	300	.5 @ 12V
F38-2060R-1	LED Replacement Tube Light, Wht/Red	1-1/2"	20"	1-1/2"	300	.5 @ 12V
F38-4600WHA-1	LED Spreader Light	3-7/16"	5"	2-3/16"	675	.5 @ 12V



LED LIGHTS

Rub Rail Mounted LED Navigation Lights

Stainless Steel Type 304 High Polished Finish

- > Meets ABYC/USCG requirements for both sail and power boat designation
- > Anodized Aluminum heat sink for maximum heat dissipation
- > Set includes 3-Watt Port (Red) and Starboard (Green) LEDs
- > IP68 rating for "wet locations"
- > Easy installation with instructions included
- > Reliable long-life LEDs will provide years of maintenance-free service
- > 120° unobstructed view

Navigation Light Set, 4-1/2"

- Designed to fit Taco Marine's popular Rub Rail V21-9659 and Rub Rail V21-9959
- Ideal for up to 30' boats

Navigation Light Set, 2-5/8"

- Designed to fit Taco Marine's larger Flex Core Rub Rail V21-9906
- Ideal for up to 40' boats



LED Navigation Light Set

Patent #2014/0056013



F38-6600

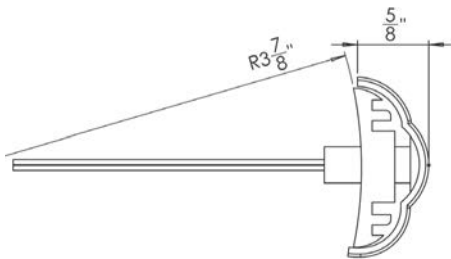

PRODUCT KNOWLEDGE

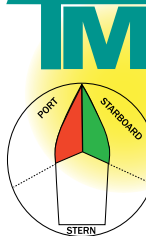

Each set of Rub Rail Mounted Navigation Lights include 2 lights: Red for port and Green for starboard.

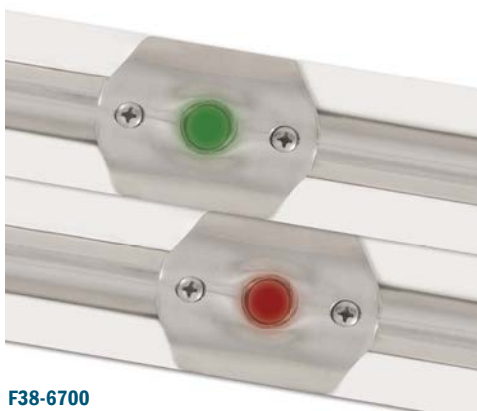
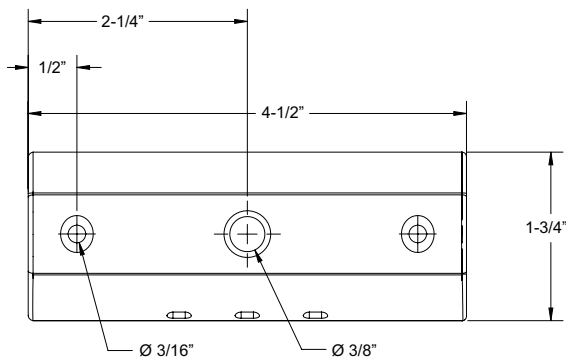

F38-6700

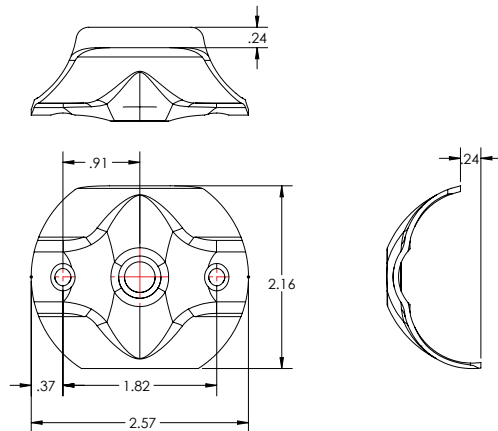

Part #	Description	Height	Width	Depth	Amperes Draw
F38-6600-1	Rub Rail Mounted Navigation Light Set, 4-1/2"	1-3/4"	4-1/2"	5/8"	.6 @ 12V
F38-6700-1	Rub Rail Mounted Navigation Light Set, 2-5/8"	2-3/16"	2-5/8"	5/8"	.6 @ 12V





LED Navigation Light Set

Rub Rail Mounted LED Navigation Lights

Stainless Steel Type 316 High Polished Finish

Navigation Light Set, Insert

- Easy installation with both Vinyl and Stainless Steel inserts
- Designed to fit Taco Marine's popular Rub Rails that take 3/4" insert
- Ideal for up to 30' boats

Surface Mount Side Light Set

- Easy installation with marine adhesive sealants
- Low profile round navigation light set (Red and Green) designed to mount on both sides of cabin or hard top for clear, elevated visibility
- Available with or without plug
- Ideal for up to 40' boats

Surface Mount Stern Light Single

- Easy installation with marine adhesive sealants
- Low profile round navigation White light designed to mount on transom area of boat
- Available with or without plug
- Ideal for up to 40' boats



F38-6800

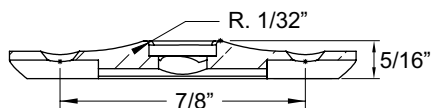
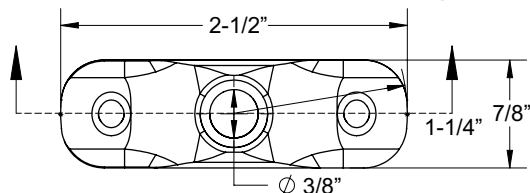

NEW!



F38-6800C-1 (w/o Plug)



F38-6800C-2 (w/Plug)



F38-6100 / F38-6610

NEW!

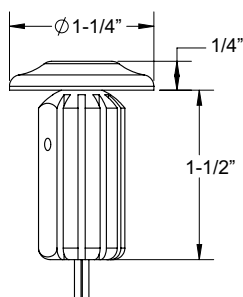

Surface Mount w/o Plug



Surface Mount w/Plug

Part #	Description	Height	Width	Depth	Amperes Draw
F38-6800C-1	∞ Rub Rail Mounted Navigation Light Set, w/o Plug	3/4"	2-1/2"	5/16"	.6 @ 12V
F38-6800C-2	∞ Rub Rail Mounted Navigation Light Set, w/Plug	3/4"	2-1/2"	5/16"	.6 @ 12V
F38-6610C-1	∞ Surface Mount Side Light Set, w/o Plug	1-1/4"	1-1/4"	1/4"	.6 @ 12V
F38-6610C-2	∞ Surface Mount Side Light Set, w/Plug	1-1/4"	1-1/4"	1/4"	.6 @ 12V
F38-6100C-1	∞ Surface Mount Stern Light Single, w/o Plug	1-1/4"	1-1/4"	1/4"	.6 @ 12V
F38-6100C-2	∞ Surface Mount Stern Light Single, w/Plug	1-1/4"	1-1/4"	1/4"	.6 @ 12V

∞Special Order



MARINE LUMBER

King Starboard® Marine-Grade Polymer Sheet

- > UV-stabilized marine-grade high-density polyethylene specifically designed to withstand harsh marine environments
- > Available in full and half sheets and cut sizes shrink-wrapped for retail merchandising
- > Excellent resistance to sun and salt water
- > Ideal wood replacement for cabinets, dock and step boxes
- > Easily drilled, cut and routed
- > Textured surface



King Starboard Polymer Sheet



Part #	Length	Width	Thick	Color
Full Sheets				
P10-5096BLK54	96"	54"	1/2"	Black
P10-5096SFM54	96"	54"	1/2"	Seafoam
P10-5096WHA54	96"	54"	1/2"	White
P10-7596BLK54	96"	54"	3/4"	Black
P10-7596SFM54	96"	54"	3/4"	Seafoam
P10-7596WHA54	96"	54"	3/4"	White
Half Sheets				
P10-5048BLK54	48"	54"	1/2"	Black
P10-5048SFM54	48"	54"	1/2"	Seafoam
P10-5048WHA54	48"	54"	1/2"	White
P10-7548WHA54	48"	54"	3/4"	White
Cut Sizes*				
P10-2506WHA12-1	12"	6"	1/4"	White
P10-2512WHA12-1	12"	12"	1/4"	White
P10-2512WHA27-1	12"	27"	1/4"	White
P10-2524BLK54-1	24"	54"	1/4"	Black
P10-2524WHA27-1	24"	27"	1/4"	White
P10-2524WHA54-1	24"	54"	1/4"	White
P10-5012BLK27-1	12"	27"	1/2"	Black
P10-5012SFM27-1	12"	27"	1/2"	Seafoam
P10-5012WHA27-1	12"	27"	1/2"	White
P10-5024BLK27-1	24"	27"	1/2"	Black
P10-5024BLK54-1	24"	54"	1/2"	Black
P10-5024SFM27-1	24"	27"	1/2"	Seafoam
P10-5024SFM54-1	24"	54"	1/2"	Seafoam
P10-5024WHA27-1	24"	27"	1/2"	White
P10-5024WHA54-1	24"	54"	1/2"	White
P10-7512BLK27-1	12"	27"	3/4"	Black
P10-7512WHA27-1	12"	27"	3/4"	White
P10-7524WHA27-1	24"	27"	3/4"	White
P10-7524WHA54-1	24"	54"	3/4"	White

*Shrink wrapped for retail merchandising





King Starboard Anti-Skid Polymer Sheet

King Starboard® Anti-Skid Marine-Grade Polymer Sheet

- > UV-stabilized high-density polyethylene
- > Special high friction surface in a diamond pattern finish prevents slipping and promotes drainage when wet
- > Resistant to harshest marine environment
- > Passes ASTM D2047 Slip Resistant testing
- > Resists most stains and does not change color
- > Does not rot or delaminate
- > Does not need refinishing
- > Chemical resistant
- > Cleans easily with marine-grade soaps or cleaners using fresh water

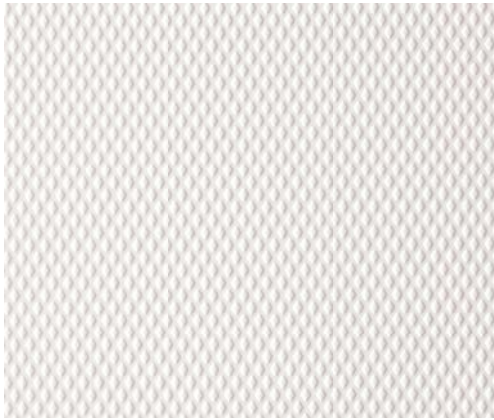

Anti-Skid



King ColorCore® Engravable Marine-Grade Polymer Sheet

- > UV-stabilized high-density polyethylene
- > Easy to engrave or machine with router
- > Cap thickness on both sides is .050"
- > Does not warp, rot or delaminate
- > Recommended for signage, plaques, ID plates

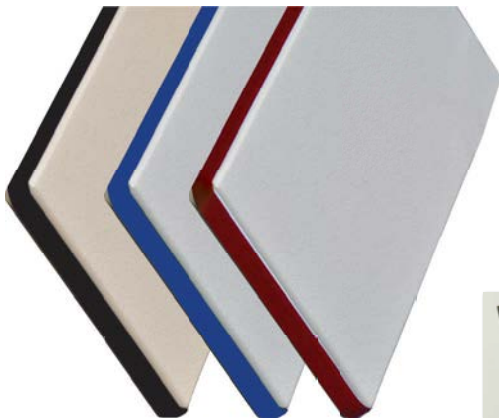

ColorCore

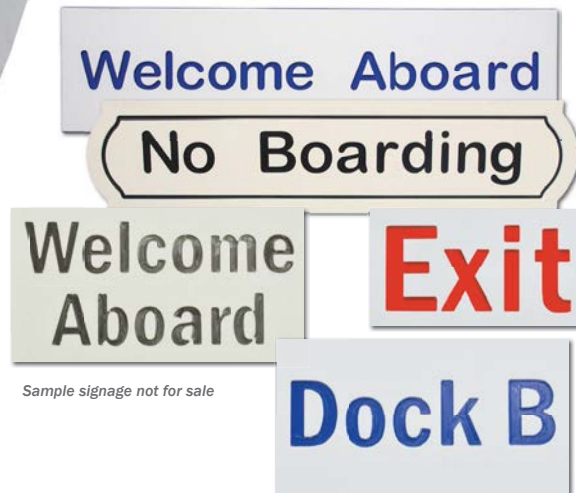

Part #	Length	Width	Thick	Color
Anti-Skid Sheet				
P14-5012WHA27-1	27"	12"	1/2"	White
P14-7512WHA27-1	27"	12"	3/4"	White
ColorCore Sheet				
P16-2512WBKW27-1*	27"	12"	1/4"	Off White-Black-Off White
P16-2512WBLW27-1	27"	12"	1/4"	White-Blue-White
P16-2512WRDW27-1	27"	12"	1/4"	White-Red-White

*Off-White



CONVERSION CHART

Fraction	Decimal	Millimeter	Fraction	Decimal	Millimeter
1/64	0.0156	0.3969	33/64	0.5156	13.0969
1/32	0.0313	0.7938	17/32	0.5313	13.4938
3/64	0.0469	1.1906	35/64	0.5469	13.8906
1/16	0.0625	1.5875	9/16	0.5625	14.2875
5/64	0.0781	1.9844	37/64	0.5781	14.6844
3/32	0.0938	2.3813	19/32	0.5938	15.0813
7/64	0.1094	2.7781	39/64	0.6094	15.4781
1/8	0.1250	3.1750	5/8	0.6250	15.8750
9/64	0.1406	3.5719	41/64	0.6406	16.2719
5/32	0.1563	3.968	21/32	0.6563	16.6688
11/64	0.1719	4.3656	43/64	0.6719	17.0656
3/16	0.1875	4.7625	11/16	0.6875	17.4625
13/64	0.2031	5.1594	45/64	0.7031	17.8594
7/32	0.2188	5.5563	23/32	0.7188	18.2563
15/64	0.2344	5.9531	47/64	0.7344	18.6531
1/4	0.2500	6.3500	3/4	0.7500	19.0500
17/64	0.2656	6.7469	49/64	0.7656	19.4469
9/32	0.2813	7.1438	25/32	0.7813	19.8438
19/64	0.2969	7.5406	51/64	0.7969	20.2406
5/16	0.3125	7.9375	13/16	0.8125	20.6375
21/64	0.3281	8.3344	53/64	0.8281	21.0344
11/32	0.3438	8.7313	27/32	0.8438	21.4313
23/64	0.3594	9.1281	55/64	0.8594	21.8281
3/8	0.3750	9.5250	7/8	0.8750	22.2250
25/64	0.3906	9.9219	57/64	0.8906	22.6219
13/32	0.4063	10.3188	29/32	0.9063	23.0188
27/64	0.4219	10.7156	59/64	0.9219	23.4156
7/16	0.4375	11.1125	15/16	0.9375	23.8125
29/64	0.4531	11.5094	61/64	0.9531	24.2094
15/32	0.4688	11.9063	31/32	0.9688	24.6063
31/64	0.4844	12.3031	64/64	0.9844	25.0031
1/2	0.5000	12.7000	1	1.0000	25.4000

IPS ("Iron Pipe Size") Conversion Chart Schedule 40 & 80 Pipe

IPS	OD		Circumference	
3/4"	1-1/16"	1.050"	3-5/16"	3.299"
1"	1-5/16"	1.315"	4-1/8"	4.131"
1-1/4"	1-11/16"	1.660"	5-7/32"	5.215"
1-1/2"	1-15/16"	1.900"	5-31/32"	5.969"
2"	2-3/8"	2.375"	7-5/32"	7.461"

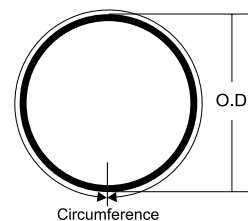

Finish Specifications

Finishes specified in this catalog reflect Taco Marine's stock finishes. Other finishes are available provided minimum quantity requirements are met and sufficient lead-time is given.

ANODIZED ALUMINUM FINISH

Anodizing is an electrolytic process that redeposits a protective coating on an Aluminum surface. This coating becomes an integral part of the Aluminum and will not peel or flake.

The following is a complete list of anodized finishes available either from stock and/or special order. Please refer to our finish codes when specifying a particular finish.

Brite Dip Finish

BLY: Silver Brite Dip and Anodized Anodized finish for chrome like appearance. Withstands corrosive environments. Extrusion flow lines may appear through the anodized finish.

Premium Brite Dip Finish

BLS: Brite Dip, Mechanically Linear Sanded and Anodized Fine wire brush and anodized finish. The mechanical brushing masks unsightly scratches that occur from contact and handling during fabrication or everyday use.

BSA: Silver Brite Dip, 320 Grit Mechanically spiral sanded and anodized, for round tube and pipe. Mechanically sanded and anodized finish for products with corrosive, high traffic exposure. The mechanical brushing masks unsightly scratches that occur from contact and handling during fabrication or everyday use.

BSS: Silver Brite Dip, 320 Grit Mechanically spiral sanded and anodized, for round pads. Mechanically sanded and anodized finish for products with corrosive, high traffic exposure. The mechanical brushing masks unsightly scratches that occur from contact and handling during fabrication or everyday use.

BSY: Silver Brite Dip, 180 or 320 Grit Mechanically lineal sanded and anodized, for extrusions. Mechanically sanded and anodized finish for products with corrosive, high traffic exposure. The mechanical brushing masks unsightly scratches that occur from contact and handling during fabrication or everyday use.

BXY: Polished, Brite Dip Anodized Simulated Stainless Steel finish for corrosive and highly aesthetically critical environments requiring the most blemish-free Aluminum extrusion available. Most extrusion flow lines are removed during the polishing process.

BXZ: Brite Dipped 800 Grit Mechanically Sanded and Anodized Finish for products with corrosive high traffic exposure. The mechanically brushed finish mask scratches that occur from everyday use and the anodic coating protects against the marine environment harsh elements. This finish matches up well next to either BSA or BXY finished products.

Standard Anodized Finish

TAL: Polished, Clear Anodized Mechanically buffed, semi-brite. A traditional anodized finish with a subtle polish. Most extrusion flow lines are removed during the polishing process.

VEL: Etch, Clear Anodized (satin) A cost effective, matte finish. Provides the greatest corrosion protection for minimal aesthetically important exposure.

No Finish

AES: Mill finish - as extruded No secondary finishing. Primarily used for industrial applications or for third party finishing or powder coating.

AEY: Mill finish - as extruded No secondary finishing. Primarily used for industrial applications or for third party finishing.

RUB RAIL / TRIM & MOULDING COLOR GUIDE*

Colors specified in this catalog reflect Taco Marine's standard Rub Rail and Trim & Moulding colors. Custom colors are available provided minimum quantity requirements are met and sufficient lead-time is given.

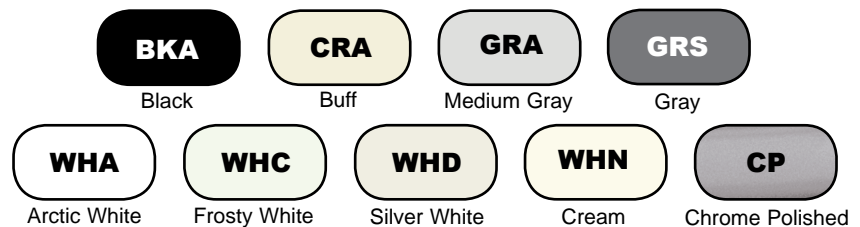

*DUE TO VARIATIONS IN THE PRINTING PROCESS, COLOR MAY VARY SLIGHTLY FROM THE ORIGINAL PRODUCT. COLOR SAMPLES AVAILABLE UPON REQUEST.

Taco Marine products are all carefully tested and inspected to ensure optimal levels of performance.

Taco Marine warrants to the original purchaser of its products that should any product be proven defective in material or workmanship within one, three or five year of original purchase, they will be repaired or replaced without charge, subject to the performance guarantees stated in this warranty.

The Taco Marine limited warranty applies to all products unless otherwise noted.

Five Year Limited Warranty:

Rub Rail Products

Trim and Moulding Products

General Hardware including Pipe and Tubing

Hinges and Latches

Taco Marine warrants to the original purchaser of its Rub Rail products that should any product be proven defective in material or workmanship within five years of original purchase, they will be repaired or replaced without charge, subject to the performance guarantees stated in this warranty. These products are intended for pleasure crafts, used for recreation. Exposure to harsh marine environments requires all products to be rinsed with fresh water after use and be regularly maintained.

Taco Marine guarantees the performance of these products as follows:

Aluminum Extrusions and Hardware are guaranteed against fading of anodized finish, corrosion, except for non-anodized surfaces resulting from cutting, machining, tight radius bending, scratching, metal to metal contact or other exposure of the base Aluminum. This guarantee does not extend to corrosion resulting from galvanic reaction (improper electrical grounding). Slight fading or dullness of finish over time is a normal occurrence of weathering and does not constitute a defect.

Vinyl Extrusions and Nylon Hardware are guaranteed against significant fading, cracking or swelling and significant reduction of plasticity, modulus, tensile strength and dimensional integrity. Slight color variation is a normal occurrence of weathering and does not constitute a defect.

Stainless Steel Lineals and Cast or Stamped Hardware are guaranteed against loss of luster, corrosion and rust, except that resulting from cutting, machining, scratching or metal to metal contact. This guarantee does not extend to corrosion or rust from galvanic reaction (improper electrical grounding). Slight luster variation over time is a normal occurrence of weathering and does not constitute a defect.

Taco Marine's liability and purchaser's exclusive remedy for damages shall not be greater than the purchase price of the actual supplied product claimed to be defective and Taco Marine shall not be liable for any indirect, incidental or consequential damages, including, but not limited to, present or prospective profits, reliance expenditures or commitments, reputation, goodwill or claims of third parties.

During this warranty period, your Taco Marine product will either be repaired or replaced without charge to the original purchaser, when returned prepaid and insured with proof of purchase date. This warranty covers repair or replacement costs and freight back to the original purchaser-consumer.

This warranty does not apply to any product that has been damaged through alteration, mishandling, misuse, neglect or accident, unless otherwise stipulated. This warranty is in lieu of all other warranties, expressed or implied and no persons or representative is authorized to assume for the company any other liability in connection with the sale of this product. Some states do not allow limitations on how long an implied warranty lasts or the exclusion or limitations of incidental or consequential damage, so the above limitations or exclusions may not apply to you.

This warranty gives you specific legal rights and you may also have other rights that vary from state to state.

Three Year Limited Warranty:

Sport Fishing Products

Taco Marine warrants to the original purchaser of Taco Marine Sport Fishing products to be free from factory defects in materials and workmanship for a period of three years from the date of purchase. Should they be proven defective in material or workmanship within three years of original purchase, they will be repaired or replaced without charge, subject to the performance guarantees stated in this warranty.

These products are intended for pleasure crafts, used for recreation. Exposure to harsh marine environments requires all products to be rinsed with fresh water after use and be regularly maintained.

This warranty excludes the following:

Damage by collision, faulty or incorrect release clips, damage of components due to corrosive cleaners or lubricants, damage as a result of a combination of rough seas and high speeds, and failure to wash off salt water. This warranty is void if product has been damaged by neglect, unreasonable use, improper service or failure to follow maintenance guidelines.

Taco Marine's liability and purchaser's exclusive remedy for damages shall not be greater than the purchase price of the actual product claimed to be defective and Taco Marine shall not be liable for any indirect, incidental or consequential damages, including, but not limited to, present or prospective profits, reliance expenditures or commitments, reputation, goodwill or claims of third parties.

During this warranty period, your Taco Marine product will either be repaired or replaced without charge to the original purchaser, when returned prepaid and insured with proof of purchase date. This warranty covers repair or replacement costs and freight back to the original purchaser-consumer.

Three Year Limited Warranty:

Seating and Table Pedestal Products

Taco Marine warrants to the original purchaser of Taco Marine's Seating and Table Pedestal products to be free from factory defects in materials and workmanship for a period of three years from the date of purchase. Should they be proven defective in material or workmanship within three years of original purchase, they will be repaired or replaced without charge, subject to the performance guarantees stated in this warranty.

Metal components are guaranteed against loss of luster, corrosion and rust, except that resulting from cutting, machining, scratching or metal to metal contact. This guarantee does not extend to corrosion or rust from galvanic reaction (improper electrical grounding). Slight diminishing of luster may occur over time as a normal occurrence of weathering and does not constitute a defect.

Fabrics are guaranteed against significant fading and shape distortion. Minor discoloration or stretch may occur over time as a normal occurrence of weathering and use and does not constitute a defect.

These products are intended for pleasure crafts, used for recreation. Exposure to harsh marine environments requires all products to be rinsed with fresh water after use and be regularly maintained.

This warranty excludes the following:

Damage by misuse, overloading, faulty or incorrect installation, damage of components or fabrics due to corrosive cleaners or lubricants, and failure to wash off salt water and otherwise provide proper care and maintenance. This warranty is void if product has been damaged by neglect, unreasonable use, improper service or failure to follow general maintenance guidelines.

Taco Marine's liability and purchaser's exclusive remedy for damages shall not be greater than the purchase price of the actual product claimed to be defective and Taco shall not be liable for any indirect, incidental or consequential damages, including, but not limited to, present or prospective profits, reliance expenditures or commitments, reputation, goodwill or claims of third parties.

During this warranty period, your Taco Marine product will either be repaired or replaced without charge to the original purchaser, when returned prepaid and insured with proof of purchase date. This warranty covers repair or replacement costs and freight back to the original purchaser-consumer.

ALPHABETICAL INDEX

A

Accessories - Seats & Pedestals SP16

- Carpet Ring SP17
- Flush Mount Base Plug SP17
- Helm Chair Slide SP16
- Leaning Post Cooler Strap SP17
- Neptune Tackle Storage Bag SP17
- Universal Leaning Post Backrest SP16

Accessories - Sport Fishing SF38

- Base Reducer SF37
- Drink Holder SF38
- Filet Table Adjustable Gunnel Mount SF39
- Fishing Knife & Plier Holder SF39
- Mounting Plate SF37
- Outrigger Line Caddy SF37
- Rigging Strip SF39
- Rod Holder Liner SF37
- Trident Tool Caddy SF39
- Tumbler Holder SF38

C

Canvas Top Fittings MF41

- Ball & Socket Top Cap MF41
- Boat Cover Pole MF47
- Canvas & Upholstery Welt & Track MF46
- Curtain Track & Components MF45
- Deck Hinge MF42
- Eye Strap MF45
- Pin & Lanyard MF45
- Top Hardware "Standard" MF43
 - Base MF44
 - Eye End MF43
 - Jaw Slide MF43
 - Nylon MF44

D

Dockside Accessories MA97

- Big Game Poly Rod Storage Cart MA99
- Come On Board Handle MA97
- Dockside Filet Table MA99
- Multi-Purpose 15° Portable Cleat MA98
- Quick Release Fender Lock MA98
- Shore Power Cable Holder MA98
- Trailer Glyde Slicks MA99

H

Helm Chairs SP6

- Capri Helm Chair SP6
- Captiva Helm Chair SP8
- Coastal Helm Chair SP9

Hinges HL89

- Butt Hinge HL90
- Command Ratchet Hinge HL92
- Continuous Hinge HL89
- Hasp Hinge HL93
- Hatch Hinge HL90
- Hidden Fastener HL93
- Intelli-Hinge HL93
- Strap Hinge HL90

Hull Accessories TM87

L

Latches HL94

- Grab Handle HL95
- Latch-tite Lifting Handle HL95
- Lifting Ring HL95
- Sundeck Latch HL94
- Walk-Thru Windshield Latch HL94

Leaning Posts SP3

- Leaning Post Footrest Hinge MF57
- Leaning Post Pins & Pads MF57
- Neptune III Leaning Post SP4
- Neptune II Leaning Post SP3
- Neptune Premium Leaning Post SP5

LED Lights MA100

- LED Deck Light Flat Mount MA100
- LED Deck Light Pipe Mount MA101
- LED Spreader Light MA103
- LED T-Top Light Pipe Mount MA102
- LED T-Top Tube Light MA103
- Rub Rail Mounted
 - LED Navigation Lights MA104

M

Marine Lumber MA106

- ColorCore Engravable Marine-Grade Polymer Sheet MA107
- Starboard Anti-Skid Marine-Grade Polymer Sheet MA107
- Starboard Marine-Grade Polymer Sheet MA106

Moulding TM82

- Angle Moulding TM82
- Channel TM86
- Drip Moulding TM84
- Edge Moulding TM82 TM86
- Flexible Vinyl TM83
- Flex Trim TM83
- Half Oval TM84
- Hatch Trim TM86
- Hull Stiffener TM87
- Slide Track TM85
- Sliding Door Track TM85
- T-Hatch Trim TM85
- U-Channel TM83
- Wire Chase TM87

O

Outrigger Kits SF26

- Center Rigger Kit SF26
- Grand Slam 170 Kit SF26
- Grand Slam 280 Kit SF26

Outrigger Mounts SF19

- Center Rigger Mount SF22
- Grand Slam 170 Top Mount SF21
- Grand Slam 280 Mount SF20
- Grand Slam 380 Mount SF19
- Striker Base Gunnel Mount SF22

P

Pipe - Aluminum MF51

- Oval Pipe MF51
- Round Pipe MF51

R

Rail Fittings MF48

- Hand Rail Fitting MF48
- Rail Fitting Base MF48

Rigging Components SF27

- Carry Bag SF27
- Eye Strap SF27
- Glass Eye SF27
- Glass Ring SF27
- Line Caddy SF27
- Line - Dacron SF27
- Line Stop SF27
- Release Clip SF27
- Shock Cord SF27

Rigging Kits SF28

- Braid Triple Rigging Kit SF29
- Center Rigging Kit SF28
- Double Rigging Kit SF28
- Mono Double Rigging Kit SF29
- Mono Triple Rigging Kit SF29
- Single Rigging Kit SF28
 - Premium Single Rigging Kit SF28
 - Standard Single Rigging Kit SF28

Rod Holders - Marine Fabrication MF58

- Deck Mount Rod Holder MF59
- Traditional Rod Holder MF59
- Weld-On Rod Holder, Flared MF58

Rod Holders - Sport Fishing SF30

- Clamp-On Adjustable Rod Holder SF30
- Kite Fishing Rod Cluster SF32
- Olympic 5-Rod Cluster SF32
- Surface Mount Rod Holder SF30
- Trident 3-Rod Cluster SF31

Rod Storage SF34

- "Bungee" Rod Holder SF33
- Pontoon Boat Tackle Rack SF33
- Reel Hanger SF36
- Rod Hanger SF36
- Rod Hanger Rack SF36
- Rod Rack - Aluminum SF35
- Rod Rack - Aluminum w/Poly SF34
- Rod Rack - Poly SF34
- Rod Rack - Transom Mount SF35
- Rod & Reel Tote'm Rack SF33

Rub Rail RR61

- Accessories RR79
 - End Cap RR79
 - Rail End RR79
 - Rigid Vinyl Insert RR79
 - Rub Strake RR79
 - Stiffener RR79
- Aluminum Rub Rail RR72
- Flexible Vinyl Dock Bumper RR69
- Flexible Vinyl Moulding U-Shape RR69
- Flexible Vinyl Rub Rail RR68
- Flexible Vinyl Sandwich-Style RR69
- Insert RR75
 - Stainless Steel RR75
 - Hollow Back RR75
 - Solid Back RR75
- Vinyl RR76
- Pre-Formed Rub Rail RR74
- Rigid Vinyl Canoe Rail RR63
- Rigid Vinyl Flex Core RR63
- Rigid Vinyl Rub Rail RR61
- Rigid Vinyl Spray Rail RR63
- Rub Rail Kits RR70
 - Flexible Vinyl Rub Rail Kit RR71
 - Semi-Rigid Vinyl Rub Rail Kit RR70
- Semi-Rigid Vinyl Rub Rail RR67

S

Seals TM81

- Hatch Tape TM81
- Weather Seal TM81

Seat Pedestal SP10

- Seat Pedestal with Slide SP10

Shapes - Aluminum MF52

- Straight Edge Angle MF52
- Structural Full Radius Edge Flat Bar MF52
- Structural Radius Angle MF52
- Structural Square Edge Flat Bar MF52

Side Mount Table Pedestal SP15

- Removable Side Mount Table Pedestal -
Stainless Steel SP15

T

Table Pedestals SP11

- Fixed Height 3" -
Stainless Steel SP14
- Fixed Height Deluxe 3" -
Aluminum SP13
- Fixed Height Standard 2-3/8" -
Aluminum SP13
- Triton 2-Stage SP12
- Triton 3-Stage SP11

Tele-Outrigger Poles SF24

- Center Rigger Pole - Aluminum SF24
- Center Rigger Pole - Carbon Fiber SF25
- Tele-Outrigger Pole - Aluminum SF24
- Tele-Outrigger Pole - Carbon Fiber SF25

Top & Tower Hardware MF53

- Pad MF54
- Pad Assembly MF56
- Pin MF53
- Radiused Specialty Pad MF55
- Specialty Hardware for Wake Tower MF56

Tube MF49

- Aluminum MF50
 - Round Tube MF50
 - Square Tube MF50
- Stainless Steel MF49
 - Elliptical Tube MF49
 - Round Tube MF49

U

Universal Mount SF23

- Grand Slam 890 Universal Mount SF23

W

Weld-On Plates MF57

- Extrusion Plate MF57

PART NUMBER INDEX

A11-0151.....	73,84	A51-0104.....	84	F13-0302.....	42	F30-2150.....	56	F36-3040.....	55
A11-0152.....	73,84	A51-0106.....	84	F13-1085.....	42	F30-2300.....	53	F36-4340.....	54
A11-0317.....	72,76	A51-0149.....	84	F13-1095.....	42	F30-2400.....	54	F36-4440.....	54
A11-0342.....	72,79	A52-0034.....	46	F14-0039.....	48	F30-2500.....	53	F36-7001.....	56
A11-0347.....	72,77	A52-0037.....	46,85	F14-0040.....	48	F30-2555.....	53	F38-2050.....	103
A11-0511.....	73	A52-0051.....	45	F14-0041.....	48	F31-0700.....	37,59	F38-2060.....	103
A11-0514.....	73	A52-0084.....	85	F14-0042.....	48	F31-0751.....	59	F38-4600.....	103
A11-0638.....	72,76	A52-0309.....	85	F14-0043.....	48	F31-0770.....	32	F38-6100.....	105
A12-0303.....	67,77,79	A62-0009.....	73	F14-0076.....	48	F31-0780.....	31	F38-6600.....	104
A12-0305.....	72,77,79	BP-150.....	37	F14-0079.....	48	F31-0781.....	31	F38-6610.....	105
A20-1464.....	50	COK-0001.....	27	F14-0081.....	48	F31-0790.....	32	F38-6700.....	104
A23-1458.....	50	COK-0004.....	27	F14-0093.....	48	F31-1600.....	59	F38-6800.....	105
A23-3458.....	50	COK-0008.....	27	F16-0005.....	15	F31-1610.....	59	F38-8500.....	100
A23-7858.....	50	COK-0017.....	27	F16-0006.....	15	F31-2200.....	37,58	F38-8505.....	100
A23-7895.....	50	COK-0018.....	27	F16-0021.....	95	F31-2201.....	37	F38-8600.....	101
A40-0812.....	68,79	COK-0020.....	27	F16-0039.....	79	F31-2230.....	58	F38-8800.....	100,101
A40-0822.....	52	COK-0022.....	27	F16-0080.....	15	F31-2240.....	58	F38-8805.....	100
A40-1043.....	52	COK-0024.....	27	F16-0094.....	46	F31-2300.....	37,58	F38-9600.....	102
A40-1139.....	52	COK-0043.....	27	F16-0150.....	22	F31-2301.....	37	F40-0018.....	15
A40-1165.....	52	F11-0100.....	43	F16-0151.....	98	F31-2320.....	58	F40-0024.....	56
A40-1187.....	52	F11-0107.....	43	F16-0212.....	22	F31-3003.....	35	F40-0030.....	27,37
A40-1202.....	52	F11-0160.....	43	F16-0311.....	22,26	F31-3004.....	35	F40-0112.....	45
A40-1217.....	52	F11-0171.....	41	F16-1090.....	95	F31-3103.....	34	F40-0119.....	45
A40-2040.....	52	F11-0172.....	43	F16-1200.....	27,45	F31-3104.....	34	F40-0278.....	44
A42-0055.....	51	F11-0174.....	43	F16-2500.....	95	F31-3503.....	35	F40-0300.....	44
A42-0136.....	51	F11-0177.....	41	F16-2525.....	95	F31-3504.....	35	F40-0302.....	44
A42-0195.....	51	F11-0180.....	41	F16-2600.....	30	F32-0600.....	55	F40-0504.....	44
A42-0360.....	50	F11-0182.....	41	F16-2623.....	30	F32-0650.....	55	F40-0704.....	45
A42-0363.....	52	F11-1000.....	43	F16-2630.....	30	F32-2040.....	54	F40-0718.....	44
A42-0364.....	52	F11-1001.....	41	F16-2700.....	36	F32-3040.....	54	F40-0878.....	44
A42-0365.....	52	F12-0101.....	43	F16-2751.....	36	F32-3043.....	55	F41-2700.....	30
A42-0382.....	51	F12-0161.....	43	F16-2752.....	36	F32-3355.....	55	F42-2500.....	95
A45-0352.....	51	F12-0181.....	41	F16-2753.....	36	F32-4025.....	54	F45-0336.....	94
A45-0353.....	51	F12-0190.....	41	F16-2810.....	36	F32-4125.....	54	F45-0339.....	94
A45-0354.....	51	F12-0191.....	41	F16-2900.....	94	F32-4160.....	55	F90-0001.....	79
A45-0355.....	51	F12-0300.....	41	F16-3000.....	95	F32-4330.....	54	F90-0002.....	79
A45-0356.....	51	F12-1001.....	43	F16-3500.....	95	F32-4335.....	54	F90-0750.....	79
A45-8353.....	51	F13-0102.....	45	F17-0106.....	43	F32-4340.....	54	F90-1870.....	79
A45-8354.....	51	F13-0107.....	45	F17-0166.....	43	F32-4345.....	54	GS-170 ..	21,24,26,28
A45-8355.....	51	F13-0115.....	45	F19-0006.....	36	F32-4350.....	54	GS-170-2.....	21
A45-8356.....	51	F13-0200.....	44	F30-0021.....	57	F32-4435.....	54	GS-280 ..	20,24,26,28
A50-0195.....	73,84	F13-0210.....	44	F30-0861.....	98	F32-4440.....	54	GS-2801.....	20
A50-0197.....	73,84	F13-0220.....	44	F30-1751.....	56	F32-4445.....	54	GS-2841.....	26
A50-0199.....	73,84	F13-0230.....	44	F30-1821.....	53	F32-4450.....	54	GS-2842.....	26
A50-0235.....	86	F13-0235.....	44	F30-1823.....	53	F34-0002.....	57	GS-380.....	19
A50-0272.....	86	F13-0240.....	44	F30-1831.....	53,56	F34-0022.....	57	GS-380XL.....	19
A50-0275.....	86	F13-0241.....	42	F30-1833.....	53	F34-0075.....	46	GS-890.....	23
A50-0304.....	85	F13-0242.....	42	F30-1841.....	53,56	F34-0100.....	46	GSC-0025.....	37
A50-0305.....	85	F13-0244.....	42	F30-1843.....	53,56	F35-FRB.....	57	GSE-1939.....	57
A50-0326.....	86	F13-0246.....	44	F30-1851.....	53	F35-SDW125.....	56	H11-1126.....	89
A50-0375.....	85	F13-0250.....	44	F30-1852.....	56	F35-W404.....	56	H11-1144.....	89
A51-0102.....	84	F13-0301.....	42	F30-1853.....	53,56	F36-1836.....	56	H11-2006.....	89

H14-011289	M20-0227.....16	P10-7548 106	V12-0342.....77	V25-9753.....87
H14-011489	M20-0228.....16	P10-7596 106	V12-0810..... 76	V30-0109.....81
H14-011689	OC-0421.....24	P14-5012..... 107	V12-1069..... 78	V30-0113.....81
H14-020089	OC-0422.....24	P14-7512..... 107	V12-4144..... 77	V30-0135.....81
H14-030089	OC-0432.....24	P16-2512..... 107	V12-4155..... 77	V30-0202.....81
H20-011290	OT-044124	RK-0001.....28	V12-9787..... 77	V30-074481
H20-020090	OT-044224	RK-0002.....28,29	V12-9809..... 78	V30-074881
H20-023090	OT-054124	RK-0003.....29	V12-9814..... 77	V30-1005.....83
H20-030090	OT-054224	R10-051410399	V15-0034.....46	V30-1008.....83
H21-013290	OT-055124	S11-1700.....79	V15-5587.....83	V30-1312.....83
H21-013390	OT-055224	S11-1800.....79	V15-9779.....83	V30-1316.....83
H21-023290	OT-212025	S11-2000.....79	V15-9855.....69	V30-1333.....81
H21-023490	OT-216025	S11-2001.....79	V21-0188.....66	V30-1350.....83
H21-043490	OT-316025	S11-45075	V21-0205.....66	V30-1375.....83
H21-060090	OT-420025	S11-45175	V21-0456.....66	WP-15037
H21-063290	Preform RR..... 74	S11-46575	V21-0457.....66	Z10-4016.....17
H22-155091	P01-1000.....39	S11-46775	V21-0458.....66	Z10-4026.....17
H23-009291	P01-1001.....39	S11-46975	V21-0460.....66	Z10-4067.....13
H23-015791	P01-120039	S11-4500.....75	V21-087463	Z10-4070.....12,13,14
H23-149091	P01-2000.....38	S11-4511.....75	V21-1025.....62	Z10-4080.....12,13
H23-149991	P01-2001.....38	S11-4650.....75	V21-1039.....64	Z10-4085.....13
H23-400091	P01-2003.....38	S11-4670.....75	V21-3670.....66	Z10-4086.....13
H25-001692	P01-2010.....38	S11-4680.....86	V21-3671.....66	Z10-4097.....14
H30-101091	P01-2020.....38	S11-4690.....75	V21-914063	Z10-9998.....17
H30-101593	P01-2120.....39	S14-1049.....49	V21-9501.....61,65	Z20-3160.....12
H30-104493	P01-2132.....39	S14-1065.....49	V21-9502.....64	Z60-7239.....13
H30-104593	P01-3000.....39	S14-1265.....49	V21-9517.....61,65	Z60-7254.....13
H30-105091	P01-4821.....99	S14-1465.....49	V21-9602.....65	Z60-7273.....13
H30-107091	P03-062.....34	S14-7849.....49	V21-9647.....64	Z60-7279.....13
H90-040093	P03-063.....34	S14-7865.....49	V21-9648.....62	Z60-7283.....13
HA1-25..... 6	P03-064.....34	S17-1305.....49	V21-9659.....62	Z60-7288.....13
HA1-28..... 6	P03-073.....33	S17-2078.....49	V21-9662.....61	Z60-8066.....18
HA1-36..... 6	P03-07433	T10-757947	V21-9667.....64	Z60-8266.....13
HA1-40..... 6	P03-132.....33	V11-0809.....68,71	V21-9678.....65	Z76-1080.....10
HA2-23..... 6	P03-133.....33	V11-0899.....68	V21-9679.....62	Z76-1120.....10
HA3-23..... 8	P03-134.....33	V11-0948.....69	V21-9790.....62,64	Z76-1180.....10
HA11-23..... 8	P03-144.....33	V11-0961.....69	V21-9811.....67	Z76-7392.....13
HA11-25..... 7	P04-091.....30	V11-2423.....68,71	V21-9866.....62	Z76-8000.....14
HA11-28..... 7	P04-011.....30	V11-3161.....69	V21-9904.....65	Z76-9066.....13
HA21-23..... 7	P04-0111.....30	V11-3426.....68,71	V21-9906.....63	Z76-907113
HB10-20..... 9	P05-0699	V11-3447.....68,71	V21-9909.....61	Z80-2190.....12
HB11-19..... 9	P05-0899	V11-4014.....68	V21-9923.....63	Z80-2600.....12
HB21-19..... 9	P06-0699	V11-4135.....70	V21-9959.....63	Z80-2603.....12
L10-1001..... 5	P10-2506 106	V11-9669.....67	V22-3162..... 79	Z80-4001.....11
L10-1002.....16	P10-2512..... 106	V11-9795.....70	V25-0240.....82	
L10-1003..... 3,17	P10-2524..... 106	V11-9811.....70	V25-047482	
L10-1004.....17	P10-5012..... 106	V12-0003.....76	V25-0786.....82	
L10-2005..... 4	P10-5024..... 106	V12-0005.....76	V25-912482	
L10-2010..... 4	P10-5048 106	V12-0303.....77	V25-9207.....46	
M17-1465.....22	P10-5096 106	V12-0307.....78	V25-9519.....82	
M17-1565.....22	P10-7512..... 106	V12-0317.....76	V25-9543.....87	
M20-0226.....16	P10-7524..... 106	V12-0338.....76	V25-9720.....46	



**Taco Marine is a leading global manufacturer of
Marine and Sport Fishing equipment**

Our product lines consist of the following:

Seats & Pedestals

Outrigger Systems

Rod Holders, Rod Racks & Rod Storage Solutions

Canvas & Metal Fabrication

Tube, Pipe & Fittings

Rub Rail, Trim & Marine Extrusions

Hinges & Latches

LED Lighting

Marine Polymer & Poly Accessories

Discover other marine electronics and navigation on our website.