



2018



GetOffGrid









Few brands in the off-road industry can match the legacy of Smittybilt. For over 60 years, Smittybilt has been the brand customers trust to outfit their Jeeps and trucks with reliable, functional accessories. All Smittybilt products are created by off-road enthusiasts who recognize a need for something better than what has been previously available. This deep heritage of innovation continues today with over two thousand unique products for not only Jeeps, but trucks and SUVs as well.

Smittybilt is best known for their distinctive bumpers and armor. However, their expansive line extends well beyond Jeep accessories and includes trail equipment, winches, soft goods and much more. Smittybilt's winch products offer the best value in the industry and are packed with features typically reserved for products costing much more, with sizes tailored to fit everything from ATVs to full-size trucks.

Backed by the superior customer service and the best warranty in the industry, Smittybilt service doesn't end with your purchase. Smittybilt, Get the Original.





M-1A2 // Bumpers.....	10
M-1 // Bumpers.....	13
M-1 // Fender Flares.....	14
M-1 // Grilles.....	15
Steps // Nerf Steps.....	16
Steps // Sure Steps.....	17
Smittybilt Defender Rack.....	18
Smittybilt Defender Rack // Accessories.....	22
Cargo Management // Contractors Rack.....	23
Cargo Management // Rugged Rack.....	23
Cargo Management // Adventure Box.....	24
Cargo Management // Accessories.....	24
Tonneau Covers // SmartCover.....	25

# TRUCK ACCESSORIES



*"Smittybilt M-1 bumper on my FJ Trail Team... bumper was so easy to install and the fit was perfect.. You have me as a customer for life!"*

*– Bob M.*







GET THE ORIGINAL

Bumpers // Atlas.....JK..... 29

Bumpers // XRC Gen2.....JK..... 30

Bumpers // SRC Gen2.....JK..... 34

Bumpers // 10x Modular.....JK..... 38

Bumpers // M.O.D. (Multi-Optional Design).....JK..... 39

Bumpers // XRC Gen1 Classic.....JK..... 40

Bumpers // XRC.....TJ LJ YJ CJ XJ..... 41

Bumpers // SRC Carbine Bumper.....JK..... 44

Bumpers // SRC Stinger.....JK TJ YJ..... 45

Bumpers // SRC Gen1.....TJ YJ CJ..... 46

Bumpers // SRC Ultra Classic.....JK..... 47

Bumpers // SRC Classic.....TJ YJ LJ..... 48

Bumpers // Tubular.....Wranglers..... 49

Tire Carriers & Tailgate..... 50

Steps..... 52

Sides..... 54

Hoods..... 58

Doors..... 60

Armor, Skins, Flares & Skid Plates..... 61, 62

Racks..... 66

Cage Kits..... 70

Hard Tops..... 74

Soft Tops..... 77

Soft Goods & Briefs..... 82

Mesh Tops..... 84

Cargo Restraint..... 85

Cab Covers..... 87

Seats..... 89

Seat Covers..... 92

Roll Bar Accessories..... 96

Storage & Security..... 98

Accessories & Trim..... 100



# JEEP® ACCESSORIES





*"Thank you, Smittybilt, for your awesome customer service! Had a small issue installing the bikini top myself and your guys helped me resolve the issue on the spot. I can't tell you enough how awesome it is to do business with a company who truly cares about its customers!"*

*– C. Miller, Killeen, TX*





GET THE ORIGINAL

Overlander // SCOUT Trailer Kit.....	108
Overlander // Tent & Annex .....	110
Overlander // Awning & Trail Shade .....	112
Overlander // EPS Generator & Arctic Fridge-Freezer.....	113
Soft Gear and Storage .....	114
Tools & Knives.....	115
Winches // X20 Gen2 .....	118
Winches // XRC Gen2 .....	122
Winches // ATV .....	126
Winches // Accessories.....	128
Recovery // Accessories.....	128
Repair // On-Trail Repairs.....	131
Repair // Air Compressors .....	133
Lighting & Electronics .....	134
Towing .....	135

# RECOVERY & WINCHES UNIVERSAL TRAIL EQUIPMENT



*"My Smittybilt Overlander Tent is so awesome...  
I've had nothing short of a great experience with mine!"  
– Kyle M., Denver, CO*



Shown: Overlander Tent and Roof Rack





GET THE ORIGINAL

For over 60 years, Smittybilt has been the brand customers trust to outfit their Jeeps with reliable, functional accessories. And because our products are created by off-road enthusiasts, they are made to withstand the roughest, toughest treatment that can be dished out.

That is why Smittybilt's M-1 truck line, the SRC/XRC lines of rock crawling accessories and the XRC/X20 winch families are backed by the Smittybilt Advantage Warranty – one of the strongest warranties available in the off-road market.

This warranty features limited lifetime coverage for all steel-based products, such as bumpers, sides, steps and armor, from manufacturer defects. It also offers a five-year warranty on our signature two-stage powdercoat finish, which is available in textured, satin or gloss black. For Smittybilt's line of waterproof winches, enjoy peace of mind with a lifetime mechanical warranty, as well as an extended electrical warranty (five years for X20 and three years for XRC models).

Smittybilt offers these extended warranties because they stand behind their products and want their customers to enjoy the freedom of off-roading without the worry and limits of fragile equipment. Welcome to the new Smittybilt – where history and experience lead to innovation and quality.

**LIFETIME**  
STRUCTURAL  
**5-YEAR** FINISH  
WARRANTY

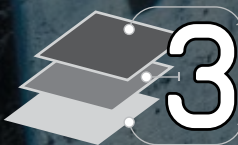

**3 STAGE TREATMENT**

Dual textured powdercoating  
Special "E-Coat" inside & out  
Acid bath dipped to remove impurities

# THE SMITTYBILT ADVANTAGE WARRANTY





Shown: New M1A2 Truck bumper. See following page



**SMITTYBILT**

GET THE ORIGINAL

**SMITTYBILT**  
NEW PRODUCT

- A** Bumper
- B** Winch Shroud
- C** Winchless Shroud
- D** Winch Cradle
- E** Removable Mesh Panels
- F** Light Brackets

**MODULAR**



1/8" steel with a 3/4" radius construction provides performance and protection



Winch cradle accommodates up to 17k winch. Can be removed with bumper installed



Removable mesh panels include provisions for 3"x3" LED cube lights



Front bumper includes 21" and (2) 6" LED light bars. Rear includes (2) 6" LED light bars



THE ALL NEW

# M1A2 HEAVY DUTY MODULAR TRUCK BUMPER

The all new M1A2 Heavy Duty Modular Truck Bumper gives you full control to transform your truck – depending on whether you want to conquer the toughest trails or simply make heads turn. The powerful, 1/8" steel bumper is smart-engineered for both strength and weight savings and the lower panels can be removed for better approach angles and tire clearance. The blazing 21" LED center light bar can be installed above your bumper to light up the darkest roads. Once off the trails, the modular design allows you to take out the winch and plate (without removal of the bumper) and install the main light bar inside the winch cavity, giving it a sleek, stylish display that will be the envy of any urbanite.

### M1A2 Front Bumper

- Modern, modular design allows front bumper to go from winch to winchless with ease
- 1/8" steel frame makes it stronger and lighter, with less flex than traditional bumpers
- 1/4" steel winch cradle offers increased durability and load capacity
- 21" LED light bar and two 6" LED side lights included
- Winch cradle can be removed or installed without bumper removal
- Mesh panels improve airflow while protecting engine components
- Optional OE 3x3 lights can be installed behind mesh panels
- Fully compatible with OE sensor packages
- Radius to match OE styling

### M1A2 Rear Bumper

- Sleek design follows truck body and matches M1A2 front bumper
- Integrated D-ring mounts for added strength
- Two bright, 6" LED light bars included
- Removable mesh panels for customization
- Mounting points provided for OE license plate lighting/trailer plug
- Fully compatible with OE sensor packages
- Radius to match OE styling



**3 STAGE TREATMENT**  
 • Dual stage powdercoating  
 • Special "E-Coat" inside & out  
 • Acid dipped to remove impurities

**LIFETIME STRUCTURAL 5-YEAR FINISH WARRANTY**

**LT LIGHT TEXTURE**

M1A2 HEAVY DUTY MODULAR BUMPER				
YEAR	MAKE	MODEL	FRONT	REAR
14-18	Chevy	Silverado 1500	612922	614922
09-18	RAM	1500	612908	614902
09-18	RAM	2500	612902	614902
15-18	Ford	F-150	612933	614933 †
17-18	Ford	F-250/F-350	612931	614931
16-18	Toyota	Tacoma	612948	614948 †
14-18	Toyota	Tundra	612941	614941
16-18	Nissan	Titan XD	612960	614960

\*Winch and cube lights sold separately  
 †Selected applications (†) include hitch assembly



Winchless shroud with 21" LED light bar installed

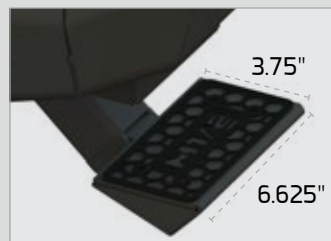

Two retractable rear steps included with each rear bumper



Adjustable rear steps have 4.7" of travel providing easy bed loading for any lift height



Integrated D-ring mounts for added strength





**BUMPER // FENDER FLARES // GRILLES**





RAM 2500

## M-1 BUMPERS

### M-1 Front Bumper

- Innovative two-piece design
- Engineered to fit and follow truck body
- Solid 1/4" plate center section that wraps the frame horns and lower crossmember
- Manufactured from 3/16" and 1/4" cold rolled steel
- Ultra bright driving lights and fog lights included
- Solid mount D-rings - welds on the inside and out
- Built-in winch plate with one-piece welded design
- Accommodates up to 17.5k winch (winch sold separately)
- Front stainless steel bezel accents
- Comes with four (4) S4 lights - (2) Flood - (2) Fog

### M-1 Rear Bumper

- Manufactured from 3/16" and 1/4" cold rolled steel
- Engineered to fit and follow truck body
- Ultra bright fog lights (rear) included
- Solid mount D-rings - welds on the inside and out
- Backup sensor mount locations on rear bumper
- Comes with (2) S4 flood lights

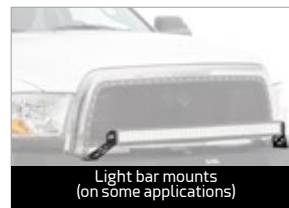

Toyota FJ

Chevy

Ford Super Duty

Ford F-150

Toyota Tundra

M-1 BUMPERS / FRONT				
YEAR	MAKE	MODEL	MAX. WINCH	PART#
09-17	Dodge	Ram 1500	12k	612808
06-09	Dodge	Ram 2500/3500 HD	17.5k	612800†
10-17	Dodge	Ram 2500/3500 HD	17.5k	612802†
14-15	Chevy	Silverado 1500	12k	612822*
07.5-10	Chevy	2500/3500 Heavy Duty	17.5k	612820†
11-14	Chevy	2500/3500 Heavy Duty	17.5k	612821†
15-17	Ford	F150	12k	612833†
08-10	Ford	F250/F350 Super Duty	17.5k	612830*†
11-16	Ford	F250/F350 Super Duty	17.5k	612831†
07-15	Toyota	FJ	12k	612850*†
07-13	Toyota	Tundra	12k	612840*†
14-17	Toyota	Tundra	12k	612841*€

M-1 BUMPERS / REAR			
YEAR	MAKE	MODEL	PART#
03-09	Dodge	Ram 2500/3500 HD	614800*
10-16	Dodge	Ram 2500/3500 HD	614802*
10-16	Dodge	Ram 1500	614802*
07.5-14	Chevy	2500/3500 Heavy Duty	614820
14-16	Chevy	Silverado 1500	614822
15-17	Ford	F150	614833
99-16	Ford	F250/F350 Super Duty	614830
07-15	Toyota	FJ	614850
07-13	Toyota	Tundra	614840*
14-17	Toyota	Tundra	614841*€

\*Must have OE hitch  
 € Will not work on vehicles with object sensor box on OE bumper





GET THE ORIGINAL

# M-1 FENDER FLARES



## M-1 FENDER FLARES

These M-1 truck fenders will not only provide additional tire coverage, they'll give your truck an instant rugged off-road look. They are constructed from an OEM-quality ABS material that is heat resistant and UV stable. As a benefit of superior material quality, these fenders are paintable. No drilling is required and all hardware, rubber gaskets and rivets are included to make fitment hassle free.

- Rugged, off-road look
- Up to 2 inches extra tire coverage to prevent road debris from hitting side of truck
- Lightly textured and paintable
- Stainless steel rivets and rubber gasket is included for tight fit

NOTE: Vehicle badging may need to be relocated



Paintable



Up To 2" Protection

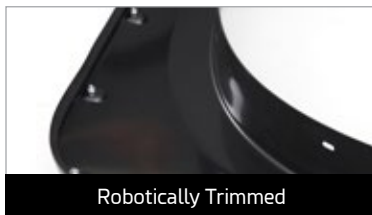

Robotically Trimmed

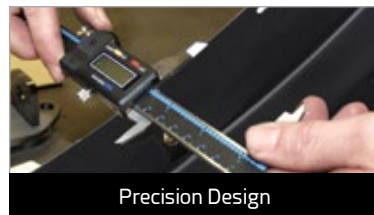

Precision Design



Before & After

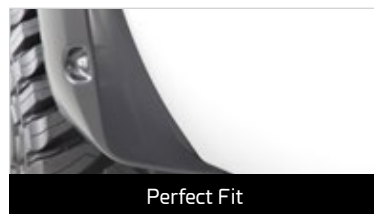

Perfect Fit



UP TO 2" OF PROTECTION



### M-1 BOLT-ON FENDER FLARES

YEAR	MAKE	MODEL	PART#
02-08	Dodge	Ram 1500	17490
03-08	Dodge	Ram 2500/3500	17490
09-18	Dodge	Ram 1500	17491
10-18	Dodge	Ram 2500/3500	17492
07-13	Chevy	1500 W/ 6.5' Or 8' Bed	17290*
07-14	Chevy	2500/3500 W/ 6.5' Or 8' Bed	17290*
07-13	Chevy	1500 W/ 5.8' Bed	17293*
14-18	Chevy	1500 W/ 5.8' Bed	17291*
14-18	Chevy	1500 W/ 6.6' Bed	17292*
15-17	Chevy	2500/3500 W/ 6.5' Or 8' Bed	17292*
99-07	Ford	F250/350 Super Duty	17390
08-10	Ford	F250/350 Super Duty	17391
11-16	Ford	F250/350 Super Duty	17392
17-18	Ford	F250/350 Super Duty	17396
04-08	Ford	F150	17393
09-14	Ford	F150	17394
15-17	Ford	F150	17395
2018	Ford	F150	17397
07-13	Toyota	Tundra	17590
14-18	Toyota	Tundra	17591
05-15	Toyota	Tacoma	17580
16-17	Toyota	Tacoma	17581
16-18	Nissan	Nissan Titan XD	17690

\* Will not work on GMC trucks





## M-1 GRILLES

- Complements the looks of today's vehicles
- Manufactured out of marine grade 304 stainless steel
- Stainless steel plated lugs
- Finished in a textured black powdercoat
- No exposed welds – robotically welded
- Modifications to the OE grille shell required
- Special heavy duty packaging to ensure grille will arrive undamaged



Toyota Tacoma



Chevy Silverado



Ford Super Duty

M-1 GRILLES				
YEAR	MAKE	MODEL	PCS	PART#
06-09	Dodge	Ram 1500/2500/3500	1	615800
09-12	Dodge	Ram 1500	1	615801
13-18	Dodge	Ram 1500	1	615803
10-12	Dodge	Ram 2500/3500 HD	1	615802
13-18	Dodge	Ram 2500/3500 HD	1	615804
07.5-10	Chevy	Ram 2500/3500 HD	2	615820
07.5-13	Chevy	Silverado 1500	2	615821
14-15	Chevy	Silverado 1500	2	615823 †
16-18	Chevy	Silverado 1500	2	615826
11-14	Chevy	Silverado HD 2500	4	615822
15-18	Chevy	Silverado HD 2500	4	615824
2017-18	Ford	F250/F350 Super Duty	1	615835
08-10	Ford	F250/F350 Super Duty	3	615830
11-16	Ford	F250/F350 Super Duty	1	615831*
09-14	Ford	F150	1	615832**
15-17	Ford	F150	1	615834**
04-08	Ford	F150	1	615833
07-18	Jeep	JK Wrangler 2/4 Door	1	615850
14-17	Toyota	Tundra	1	615843
10-13	Toyota	Tundra	1	615840***
07-09	Toyota	Tundra	1	615844
13-15	Toyota	Tacoma	3	615842
05-11	Toyota	Tacoma	3	615841
16-18	Toyota	Tacoma	1	615845

\*\*\*Does Not Fit Limited or Platinum Editions

\*\*Does Not Fit FX4 Model

\*Does Not Fit 6 Hole Grille Model

† Does Not Fit Z71 Models





**SMITTYBILT**

GET THE ORIGINAL

# NERF STEPS

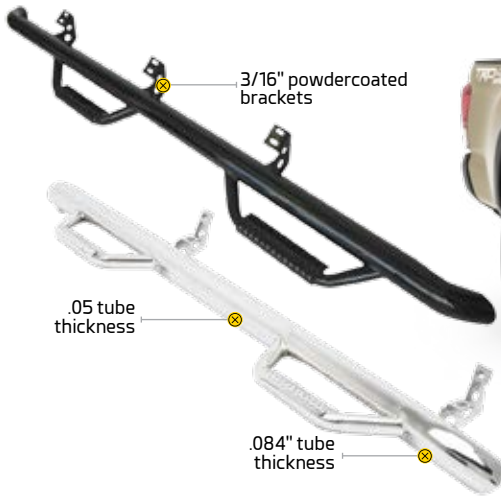

## NERF STEPS

YEAR	MAKE	MODEL	GLOSS BLACK	STAINLESS STEEL
01-06	Chevy/GMC	Silverado/Sierra Crew Cab - 6'.6" Bed	C01100CC	C01100CC-SS
07-13	Chevy/GMC	Silverado/Sierra Crew Cab 1500 - 6'.6" Bed	C0789CC	C0789CC-SS
07-14	Chevy/GMC	Silverado/Sierra HD Crew Cab - 6'.6" Bed	C07100CC	C07100CC-SS
11-14	Chevy/GMC	Silverado/Sierra HD Ext Cab - 6'.6" Bed	C1189QC	C1189QC-SS
11-14	Chevy/GMC	Silverado/Sierra HD Crew Cab - 6'.6" Bed	C11100CC	C11100CC-SS
07-13	Chevy/GMC	Silverado/Sierra Ext Cab - 6'.6" Bed	C0789QC	C0789QC-SS
99-06	Chevy/GMC	Silverado/Sierra Ext Cab - 6'.6" Bed	C9989QC	C9989QC-SS
07-13	Chevy/GMC	Silverado/Sierra Ext Cab - 6'.6" Bed	C0789QC	C0789QC-SS
14-18	Chevy/GMC	Silverado/Sierra 1500 Crew Cab - 5'.8" Bed	C1489CC	C1489CC-SS
14-18	Chevy/GMC	Silverado/Sierra 1500 Crew Cab - 6'.5" Bed	C1498CC	C1498CC-SS
14-18	Chevy/GMC	Silverado/Sierra 1500 Double Cab - 6'.5" Bed	C1489QC	C1489QC-SS
15-18	Chevy/GMC	Silverado/Sierra HD Crew Cab - 6'.5" Bed	C1598CC	C1598CC-SS
15-18	Chevy/GMC	Silverado/Sierra HD Ext Cab - 6'.5" Bed	C1589QC	C1589QC-SS
09-15.5	Dodge	Ram 1500 Crew Cab 5'.7" Bed	D0989CC	D0989CC-SS
09-15.5	Dodge	Ram 1500 Quad Cab 6'.4" Bed	D0989QC	D0989QC-SS
15.5-18	Dodge	Ram 1500 Crew Cab 6'.4" Bed	D1598CC	D1598CC-SS
15.5-18	Dodge	Ram 1500 Quad Cab 6'.4" Bed	D1589QC	D1589QC-SS
10-18	Dodge	Ram 2500/3500 Mega Cab 6'.4" Bed	D10110MC	D10110MC-SS
10-18	Dodge	Ram 2500/3500 Crew Cab 6'.4" Bed	D1098CC	D1098CC-SS
02-08	Dodge	Ram 1500/2500/3500 Quad Cab 4Dr - 6'.6" Bed	D0289QC	D0289QC-SS
09-14	Ford	F150 Super Cab - 6'.5" bed	F0989QC	F0989QC-SS
15-18	Ford	F150 Super Cab - 6'.5" bed	F1597QC	F1597QC-SS
09-14	Ford	F150 Super Crew - 5'.5" Bed	F0996CC	F0996CC-SS
15-18	Ford	F150 Super Crew - 6'.5" bed	F15107CC	F15107CC-SS
04-08	Ford	F150 Super Crew 4 Door - Short Bed	F04865C	F04865C-SS
99-16	Ford	F250/F350 Super Duty Crew Cab - 6'.6" Bed	F99100CC	F99100CC-SS
17-18	Ford	F250/F350 Super Duty Crew Cab - 6'.6" Bed	F17100CC	F17100CC-SS
04-15	Nissan	Titan Cab - 5'.0" Bed Crew Cab	N0482CC	N0482CC-SS
16-18	Nissan	Titan XD Crew Cab	N16100CC	N16100CC-SS
06-16	Toyota	FJ Cruiser - 2" main tube (textures black)	T0654FJ	T0654FJ-SS
14-17	Toyota	4Runner	T1464R*	T1464-SS*
05-15	Toyota	Tacoma Double Cab 5' or 6' bed 2" Main Tube	T0678CC	T0678CC-SS
16-18	Toyota	Tacoma Double Cab 5' or 6' bed 2" Main Tube	T1678CC	T1678CC-SS
07-18	Toyota	Tundra Dbl Cab - 6'.6" Bed	T0786QC	T0786QC-SS
07-18	Toyota	Tundra Crew Max - 5'.0" Bed	T0786CC	T0786CC-SS

\*Does not fit Limited Models

## NERF STEPS

Smittybilt Nerf Steps are truly the next generation in side step technology. They feature a 3" main tube with an innovative four-step drop down design with a cleated step plate. Each bar is custom-made for each application and provides one of the sturdiest attachments in the industry. The new stainless steel bars are constructed completely of 304 marine grade stainless steel and comes with a limited lifetime warranty. The drop steps are welded on and then ground down and smoothed out to provide a truly finished look. Nerf Steps are also available for Jeep applications.

- Designed to go wheel-to-wheel on all models
- Most Nerf Steps have a 445 lb. weight rating – the highest in the industry
- The drop-down step features a welded, cleated step plate that won't crack or break
- Welded one-piece units for faster, easier installation – no assembly needed or brackets to bolt on
- No drilling required on most applications
- No modification necessary on trucks with body lift
- High-gloss black powdercoat or polished stainless steel finish

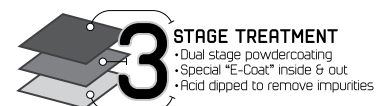



## SURE STEPS

All Smittybilt Sure Steps™ are custom fit to the specific vehicle application. Unlike other brands, we do not use generic length tubes with cheap brackets. Smittybilt incorporates a third center bracket for greater strength. The 300 lb. weight rating makes the Sure Step™ the firmest, easiest to install tube step ever created. Every Sure Step™ uses powdercoat painted 3/8"-1/4" steel. No drilling of brackets is required. All step pads are secured with five pins into a compressed step area. No exposed metal to rust or flimsy pad attachments! Each bracket has been custom designed to ensure a "No Bounce" fit and ease of installation. Powdercoated Sure Steps™ are pretreated with an "E-Coat" creating a rust barrier found only on OEM manufacturing levels and very few other side bar steps. Each Sure Step™ has been tested to a minimum 500-hour salt spray test. On a side-by-side comparison, our competition failed at 250 hours! Sure Steps are also available for Jeep applications.

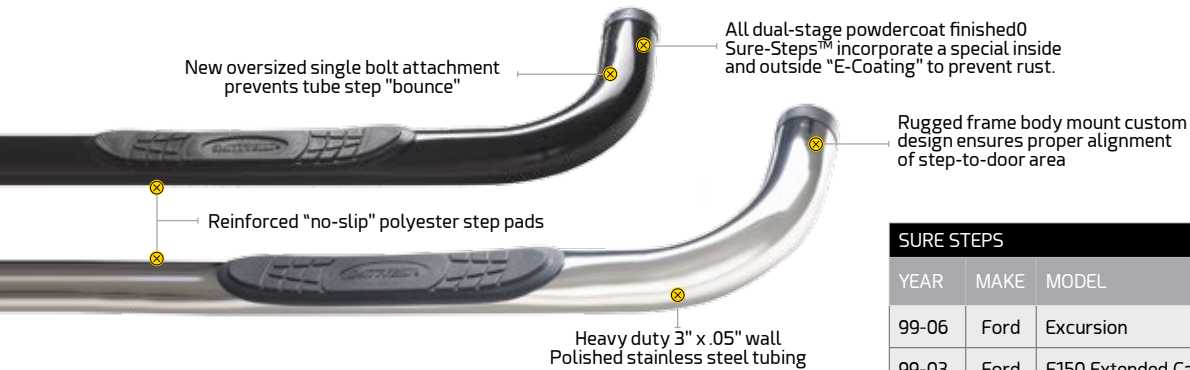

DESCRIPTION	PART#
Replacement Step Pad	PST-01

SURE STEPS				
YEAR	MAKE	MODEL	GLOSS BLACK	STAINLESS STEEL
00-14	Chevy/GMC	Avalanche 1500	CN1190-S4B	CN1190-S4S
88-98	Chevy/GMC	CK 1500/2500/3500 Extended Cab	CN180-S4B	CN180-S4S
14-18	Chevy/GMC	Silverado/Sierra 1500 Crew Cab/2500/3500	CN1930-S4B	CN1930-S4S
99-13	Chevy/GMC	Silverado/Sierra 1500/2500 Crew Cab	CN1920-S4B	CN1920-S4S
14-18	Chevy/GMC	Silverado/Sierra 1500 Extended Cab/2500/3500	CN1940-S4B	CN1940-S4S
99-13	Chevy/GMC	Silverado/Sierra 1500/2500 Extended Cab	CN1910-S4B	CN1910-S4S
92-99	Chevy/GMC	Suburban 1500	CN012-S4B	CN012-S4S
00-18	Chevy/GMC	Suburban/Yukon XL 1500	CN1190-S4B	CN1190-S4S
95-99	Chevy/GMC	Tahoe 1500 - 2 Door	CN110-S2B	CN110-S2S
09-18	Dodge	Ram 2500/3500 Mega Cab	DN280-S4B	DN280-S4S
09-18	Dodge	Ram 1500/2500/3500 Crew Cab	DN270-S4B	DN270-S4S
06-08	Dodge	Ram 1500/2500/3500 Mega Cab	DN250-S4B	DN250-S4S
09-18	Dodge	Ram 1500/2500 Quad Cab	DN260-S4B	DN260-S4S
02-08	Dodge	Ram 1500 Quad Cab	DN240-S4B	DN240-S4S
03-08	Dodge	Ram 2500/3500 Quad Cab	DN240-S4B	DN240-S4S
94-01	Dodge	Ram 1500/2500/3500 Quad Cab	DN230-S4B	DN230-S4S

SURE STEPS				
YEAR	MAKE	MODEL	GLOSS BLACK	STAINLESS STEEL
99-06	Ford	Excursion	FN1700-S4B	FN1700-S4S
99-03	Ford	F150 Extended Cab	FN1730-S4B	FN1730-S4S
04-08	Ford	F150 Super Cab	FN1960-S4B	FN1960-S4S
09-14	Ford	F150 Super Cab	FN1980-S4B	FN1980-S4S
15-18	Ford	z	FN1985-S4B	FN1985-S4S
01-03	Ford	F150 Super Crew	FN1750-S4B	FN1750-S4S
04-08	Ford	F150 Super Crew	FN1970-S4B	FN1970-S4S
09-14	Ford	F150 Super Crew	FN1990-S4B	FN1990-S4S
15-18	Ford	F150 Super Crew	FN1995-S4B	FN1995-S4S
99-16	Ford	F250/F350 SD Crew Cab	FN1700-S4B	FN1700-S4S
99-16	Ford	F250/F350 SD Super Cab	FN1680-S4B	FN1680-S4S
17-18	Ford	F250/F350 SD Crew Cab	FN1995-S4B	FN1995-S4S
17-18	Ford	F250/F350 SD Super Cab	FN1985-S4B	FN1985-S4S
06-15	Toyota	FJ Cruiser	TN1240-S4B	TN1240-S4S
04-06	Toyota	Tundra Crew Cab	TN1140-S4B	TN1140-S4S
07-17	Toyota	Tundra Crew Max	TN1220-S4B	TN1220-S4S
07-17	Toyota	Tundra Double Cab	TN1210-S4B	TN1210-S4S
00-06	Toyota	Tundra Extended Cab	TN1080-S4B	TN1080-S4S
02-04	Toyota	Tacoma Double Cab	TN1130-S4B	TN1130-S4S
05-18	Toyota	Tacoma Double Cab	TN1160-S4B	TN1160-S4S
95.5-04	Toyota	Tacoma Extended Cab	TN1120-S2B	TN1120-S2S
05-18	Toyota	Tacoma Extended Cab	TN1170-S4B	TN1170-S4S
05-14	Toyota	Hilux Extended Cab	TN1260-S4B	TN1260-S4S
05-14	Toyota	Hilux Crew Cab	TN1270-S4B	TN1270-S4S
04-18	Nissan	Titan Crew Cab	NN1450-S4B	NN1450-S4S
04-18	Nissan	Titan Extended Cab	NN1440-S4B	NN1440-S4S

**3 STAGE TREATMENT**

- Dual stage powdercoating
- Special "E-Coat" inside & out
- Acid dipped to remove impurities

**LIFETIME STRUCTURAL 5 YEAR FINISH WARRANTY**

**GB GLOSS BLACK** **SS STAINLESS STEEL**





**SMITTYBILT**

GET THE ORIGINAL

## **SMITTYBILT** *Defender Rack*

Smittybilt has the answers to all your storage and cargo needs. Made with heavy duty 16-gauge steel, the Smittybilt Defender Rack series maximizes your cargo carrying capabilities while boasting aerodynamic styling that complements today's vehicles.

Racks feature fully welded joints and light tabs; one-inch tubing that acts as a base for a variety of attachments; integrated flooring to maximize functionality; and multiple mounting options for a wide variety of applications.

Choose from three versions: the one-piece rack offers additional structural stability with fewer moving pieces; the two-piece bolt-together version is shippable via UPS for added convenience; and the platform rack is perfect for mounting large items, such as a tent. Speciality packages are also available for customers with vans. These packages are available in either a 9.5 ft. or 12 ft. lengths, can be modified by installing additional center sections and come complete with the rack and mounting kits.

Optional mounts for axes, shovels, trail jacks and spare tires can also be bolted directly on to your Smittybilt Defender Rack. All Smittybilt Defender Rack products are finished in Smittybilt's signature two-stage matte black textured powdercoat and backed by some of the industry's best warranties.



# SMITTYBILT DEFENDER RACK

## SMITTYBILT Defender Rack

Toyota 4-Runner  
PLATFORM #45555

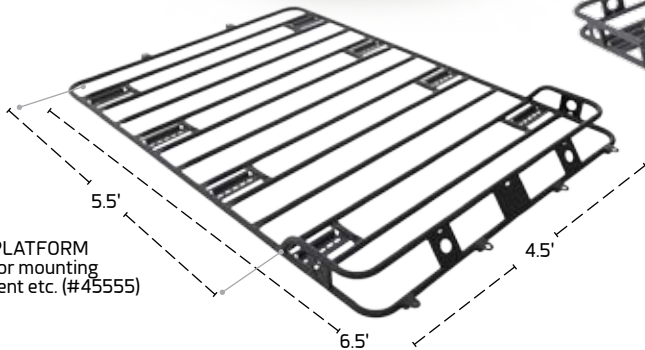

PLATFORM  
for mounting  
tent etc. (#45555)

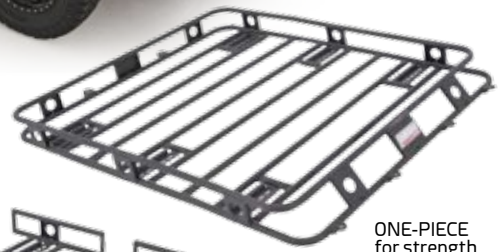

ONE-PIECE  
for strength

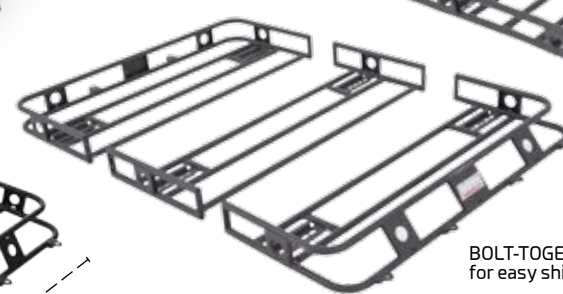

BOLT-TOGETHER  
for easy shipping

### NEW DEFENDER PLATFORM FLAT RACK:

- Constructed with heavy duty 16-gauge steel
- Works with Smittybilt SRC Roof Rack (#76717)
- Works with Smittybilt XRC Exoskeleton (#76840)
- See application guide for more fitment options
- Confirm roof measurements before ordering

\*Flat rack suitable to mount large objects like Overlander Tent (2783).  
See next page for application information, accessories and more.

**LIFETIME**  
STRUCTURAL  
**5-YEAR** FINISH  
WARRANTY

TEXTURED  
**TB**  
BLACK

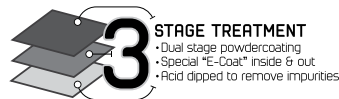

#### 3 STAGE TREATMENT

- Dual stage powdercoating
- Special "E-Coat" inside to out
- Acid dipped to remove impurities

#### DEFENDER PLATFORM RACK

SIZE	
4.5'x6.5'	45555

#### DEFENDER RACKS BY SIZE

SIZE	ONE-PIECE	BOLT-TOGETHER
3.5'x5'	35504	35505
3.5'x6'	35604	35605
4'x2'	40204	—
4'x4'	40404	40405
4'x5'	40504	40505
4.5'x5'	45504	45505
4.5'x5.5'	45555*	—
5.5'x5'	55504	55505
5'x7'	50704	50705



Perfect for mounting large objects like  
Smittybilt Overlander Tent (#2783)



Fits Trucks/Jeeps/SUV



Will work with factory roof rails



Compatible with accessory mounts  
for trail jack, axe, gas can and shovel



Fully welded joints and light mount tabs



Compatible with LED light bar  
mounting kit





GET THE ORIGINAL

# SMITTYBILT DEFENDER RACK

## SMITTYBILT DEFENDER RACKS (BY APPLICATION)

CHEVROLET/GMC						
YEAR	SIZE	MODEL	SIZE	1 PIECE	BOLT TOGETHER	MOUNT
06-13	Fullsize	Tahoe LT/LS/LTZ w/factory roof rack	4'x5'	40504	40505	DS2-6
00-05	Fullsize	Yukon/Tahoe/Suburbanw/factory rack	4.5'X5'	45504	45505	DS2-6
96-05	Fullsize	Yukon/Tahoe/Suburban-z models w/rack	4.5'X5'	45504	45505	DS4-6
94-95	Fullsize	Blazer/Yukon/Tahoe/Suburbanw/factory rack	4.5'X5'	45504	45505	DS1-6
1993	Fullsize	Blazer/Yukon/Tahoe/Suburban w/factory rack	4.5'X5'	45504	45505	DS3-6
00-05	Fullsize	Blazer/Yukon/Tahoe/Suburbanw/factory rack	4.5'X5'	45504	45505	DS2-6
2006	Fullsize	Trail Blazer w/factory roof rack	4'x4'	40404	40405	DS25-4
73-91	Fullsize	Blazer	4.5'X5'	45504	45505	AM-6
69-72	Fullsize	Blazer	5'x7'	50704	50705	AM-8
99-04	Fullsize	Cadillac Escalade w/factory roof rack	4.5'X5'	45504	45505	DS4-6
06-13	Fullsize	Avalanche LTZ w/factory roof rack	4'x4'	40404	40405	DS2-4
02-05	Fullsize	Avalanche w/factory roof rack	4'x4'	40404	40405	DS2-4
02-13	Fullsize	Avalanche w/out fac roof rack	4'x4'	40404	40405	AM-4
07-13	Fullsize	Suburban	4'x4'	40404	40405	DS4-6
2006	Fullsize	Suburban Z-71 w/factory roof rack	4'x5'	40504	40505	DS4-6
00-13	Fullsize	Suburban w/factory roof rack	4.5'x6.5'	45654	45655	DS2-8
96-99	Fullsize	Suburban w/factory roof rack	4.5'x6.5'	45654	45655	DS4-8
69-95	Fullsize	Suburban	5'x7'	50704	50705	AM-8
00-16	Fullsize	Pick up crew cab	4'x5'	40504	40505	AM-6
73-99	Fullsize	Crew cab 4 door	4'x4'	40404	40405	AM-4
00-16	Fullsize	G1500-G3500 Van	5'x7'	50704	50705	AM-8
72-94	Fullsize	G10-G30/G1500-G3500 Van	5'x7'	50704	50705	HD-8
DODGE / RAM						
03-17	Fullsize	Ram Crew Cab	4X5	40504	40505	AM-6
03-17	Fullsize	Ram Ext Cab	4X4	40404	40405	AM-4
74-93	Fullsize	Ramcharger/ Trailduster	4'x5'	40504	40505	AM-6
94-05	Fullsize	Van	5'x7'	50704	50705	HD-8
04-05	Midsize	Durango-w/factory roof rack	3.5'x5'	35504	35505	DS16-6
97-03	Midsize	Durango-w/factory roof rack	3.5'x5'	35504	35505	DS6-6
FORD						
07-13	Fullsize	Expedition w/factory roof rack	4'x5'	40504	40505	DS28-4
05-06	Fullsize	Expedition w/factory roof rack	3.5'x6'	35604	35605	DS1-8
97-04	Fullsize	Expedition w/factory roof rack	3.5'x6'	35604	35605	DS2-8
99-05	Fullsize	Excursion w/factory roof rack	4.5'x6.5'	45654	45655	DS2-8
78-96	Fullsize	Bronco	4.5'x5'	45504	45505	AM-6
99-17	Fullsize	Super Duty - Crew cab pick up	4.5'x5'	45504	45505	AM-6
75-17	Fullsize	E100-E350 Van	5'x7'	50704	50705	HD-8
78-17	Fullsize	Crew cab 4 doorW	4'x5'	40504	40505	AM-6
88-17	Midsize	Ranger reg cab and x-cab	4'X2'	40204	—	AM-4
07-17	Midsize	Sport-track XLT / Limited	4'x4'	40404	40405	AM-4
07-08	Midsize	Explorer w/factory roof rack	3.5'x5'	35504	35505	DS10-6
91-02	Midsize	Explorer w/factory roof rack	3.5'x5'	35504	35505	DS2-6
07-08	Midsize	Escape w/factory roof rack	4'x4'	40404	40405	DS1-4
01-06	Midsize	Escape w/factory roof rack	4'x4'	40404	40405	DS2-4
08-11	Midsize	Sport-track Adrenalin	4'x4'	40404	40405	AM-8



AM

### AM - DRILL-IN MOUNTS (ADJUST-A-MOUNT)

Designed for the vehicle's roof without rain gutters or mounting on any other flat surface. Rubber expansion nuts attach the pivoting base plate bracket to the roof. The upper bracket then attaches to the base plate and rack. This system requires drilling the vehicles roof and should be considered permanent.



DS

### DS - O.E. MOUNTS

The hardware kits are vehicle specific. They are designed to attach a Defender Roof Rack to the factory roof rack rails without drilling or modifications.



# SMITTYBILT DEFENDER RACK



## HD/HDS-RAIN GUTTER MOUNTS

The heavy duty rain gutter clamps are designed to mount to vehicles with factory roof to rain gutters. Rain gutter clamps are available in two heights. HD Part # (6" from bottom of clamp to the top of the extension bracket) HDS Part # (3" from bottom of clamp to the top of the extension bracket)

## SMITTYBILT DEFENDER RACKS (BY APPLICATION)

NISSAN							
YEAR	SIZE	MODEL	SIZE	1 PIECE	BOLT TOGETHER	MOUNT	
04-08	Midsize	Titan 2-door	4'X2'	40204	—	AM-4	
04-17	Midsize	Titan 4-door	4'x5'	40504	40505	AM-6	
86.5-13	Midsize	Pathfinder w/factory roof rack	3.5'x5'	35504	35505	DS2-6	
86.5-99	Midsize	Pathfinder w/o factory roof rack	4'x5'	40504	40505	AM-6	
00-13	Midsize	Xterra w/factory roof rack	3.5'x5'	35504	35505	DS17-6	
00-17	Midsize	Frontier 4-door w/o roof rack	4'x4'	40404	40405	AM-4	
TOYOTA							
95-17	Midsize	Tacoma 2-door	4'X2'	40204	—	AM-4	
95-17	Midsize	Tacoma 4-door	4'X4'	40404	40405	AM-4	
06-17	Midsize	Tacoma crew cab	4'X4'	40404	40404	AM-4	
04-17	Midsize	Hilux 2-door	4'X2'	40204	—	AM-4	
04-17	Midsize	Hilux 4-door	4'X4'	40404	40405	AM-4	
00-05	Midsize	Tundra-XT	4'X4'	40404	40405	AM-4	
06-17	Midsize	Tundra-Crew Cab	4'X5'	40504	40505	AM-6	
04-17	Midsize	4Runner w/factory roof rack	4'X5'	40504	40505	DS23-6	
86-02	Midsize	4Runner w/factory roof rack	3.5'x5'	35504	35505	DS2-6	
00-05	Fullsize	80 Series Landcruiser w/factory roof rack	4'X5'	40504	40505	DS4-6	
90-98	Fullsize	80 Series Landcruiser w/factory roof rack	3.5'X5'	35504	35505	DS10-6	
81-90	Fullsize	60 Series Landcruiser	5'X7'	50704	50705	HD-8	
HUMMER / ISUZU / LINCOLN / MITSUBISHI							
05-09	Fullsize	H2 SUT w/factory roof rack	5.5'x5'	55504	55505	DS24-6	
03-09	Fullsize	H2 w/ or w/o light bar w/factory roof rack	5.5x5'	55504	55705	DS2-6	
05-09	Midsize	H5 with factory roof rack H3	4'x5'	40504	40505	DS2-6	
98-01	Fullsize	Trooper 4-door w/o factory rack	3.5'x5'	35504	40505	AM-6	
84-93	Fullsize	Trooper	4.5'x5'	45504	45505	HDS-6	
84-93	Fullsize	Trooper	4.5'x6.5'	45654	45505	HDS-6	
03-05	Fullsize	Aviator w/factory roof rack	4.5'x5'	45504	45505	DS4-6	
UTV - YAMAHA							
04-07	Rhino	Rhino w/factory roof rack	4'x2'	40204	—	DS29-4	

## SMITTYBILT DEFENDER RACKS FOR VANS AND MOTORHOMES

Model	Size	Part#	Clamp Kit	Clamp Style
4" Tall Bolt-Together Rack for Vans, Motorhomes	5'x9.5'	50955HD	Included	HD-8 Included
4" Tall Bolt-Together Rack for Vans, Motorhomes	5'x12'	50125HD	Included	HD-12 Included
4" Tall Bolt-Together Rack for Vans, Motorhomes	5'x9.5'	50955AM	Included	AM-8 Included
4" Tall Bolt-Together Rack for Vans, Motorhomes	5'x12'	50125AM	Included	AM-12 Included

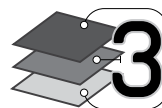
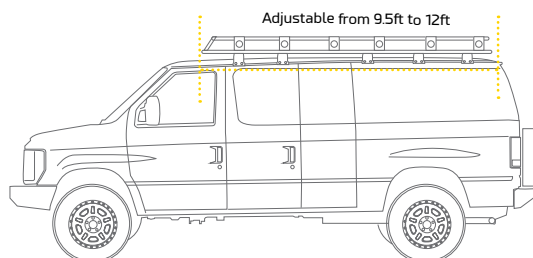

**3 STAGE TREATMENT**  
 • Dual stage powdercoating  
 • Special "E-Coat" inside & out  
 • Acid dipped to remove impurities

**LIFETIME**  
 STRUCTURAL  
**5-YEAR**  
 WARRANTY

**TEXTURED**  
**TB**  
 BLACK



# SMITTYBILT DEFENDER RACK

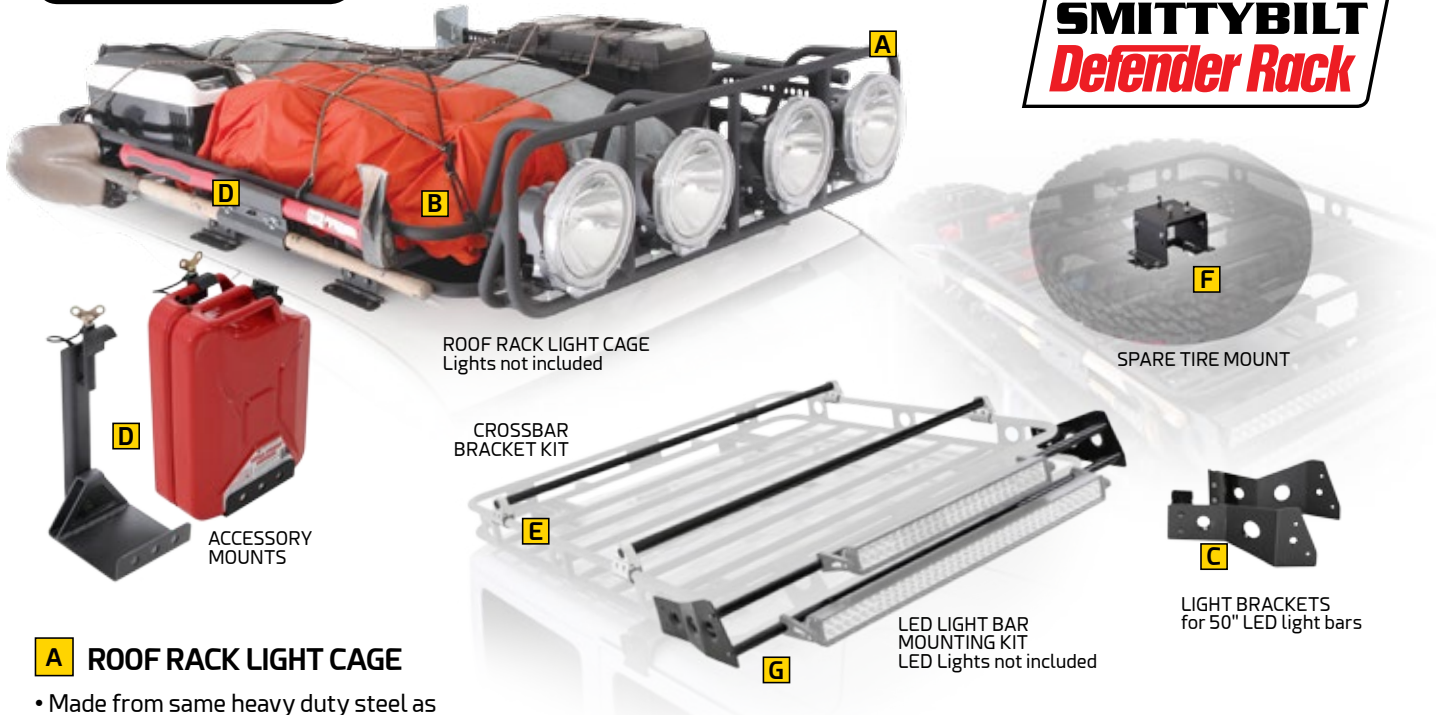

**A** ROOF RACK LIGHT CAGE  
Lights not included

**F** SPARE TIRE MOUNT

**E** CROSSBAR BRACKET KIT

**G** LED LIGHT BAR MOUNTING KIT  
LED Lights not included

**D** ACCESSORY MOUNTS

ACCESSORY MOUNTS



**C** LIGHT BRACKETS for 50" LED light bars

## A ROOF RACK LIGHT CAGE

- Made from same heavy duty steel as Smittybilt Defender Racks
- Provides protection for four of your lights that have a diameter of up to nine inches (lights not included)

[A] ROOF RACK LIGHT CAGE

DESCRIPTION	PART #
Fits 4' wide Smittybilt Defender Rack	40002
Fits 4.5' wide Smittybilt Defender Rack	45002
Fits 5' wide Smittybilt Defender Rack	50002

## B CARGO NET

- Keep your gear safe and in place
- Nets will attach to almost any roof rack, truck bed and most trailers
- Stretchy style cord that will always conform to your load
- Available in two sizes

[B] CARGO NET

DESCRIPTION	PART #
Large - 48" x 94" un-stretched 80" x 157" stretched	DN11101
Small - 48" x 48" un-stretched 80" x 80" stretched	DN11201

## C BRACKETS FOR 50" LED LIGHT BARS

- No drilling required, all hardware included

\* Works with 4' racks only

[C] LIGHT BRACKETS

DESCRIPTION	PART #
Brackets only for 4' rack (pair)	D8083

## D ACCESSORY MOUNTS

- Heavy duty steel mounting brackets provide secure fastening of axe, shovel or trail jack to your Smittybilt Defender Rack
- Mounts and hardware included
- Brackets can accept a standard padlock for security (padlock and trail jack not included)
- Mount only - accessories sold separately

[D] ACCESSORY MOUNTS

DESCRIPTION	PART #
Axe & Shovel Mount w/ Adapter Brackets	D8138
Trail Jack Mount w/ Adapter Brackets	D8076
Axe & Shovel Brackets	D8005
Trail Jack Mounts	D7031
Gas Can Mount	D8007

## E CROSSBAR BRACKET KIT

- CNC steel
- Fits all Defender by Smittybilt racks - easy install
- Can be used to attach Yakima or Thule-type accessories
- Black textured finish
- Includes four brackets

[E] CROSSBARS

DESCRIPTION	PART #
Crossbar Bracket Kit	D8081

## F SPARE TIRE MOUNT

- Attaches securely to Smittybilt Defender Rack
- Allows storage of spare tire up to 33" in diameter
- Adapter is adjustable for varying wheel widths

[F] SPARE TIRE MOUNT	
BOLT PATTERN	PART #
5 x 4-1/2"	D8545
5 x 5-1/2"	D8555
6 x 5-1/2"	D8655
8 x 6-1/2"	D8865
8 on 170mm	D8875

## G LED LIGHT BAR MOUNTING KIT

- Dual level mounting system for Smittybilt Defender Racks allows you to mount LED light bars up to width of your rack
- Adjustable for all sizes of light bars
- Kit includes 1" crossbars, side brackets and four CNC-machined light bar tabs
- No drilling required. Lights not included
- Light Tabs also available (sold separately, per pair)

[G] LED LIGHT BAR MOUNTS

DESCRIPTION	PART #
4' LED Light Bar Mount Kit	D8084
4.5' LED Light Bar Mount Kit	D8045
5' LED Light Bar Mount Kit	D8085
Light Bar Tabs only (pair)	D8082

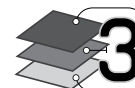

**3 STAGE TREATMENT**  
• Dual stage powdercoating  
• Special "E-Coat" inside & out  
• Acid dipped to remove impurities

**LIFETIME**  
STRUCTURAL  
**5 YEAR**  
FINISH  
WARRANTY







## CONTRACTORS RACK

This featured lumber rack can fit any full-size truck of any bed length or cab configuration. Smittybilt's innovative modular design and no drill bracketry gives you a removable installation option for complete bed access in minutes. Hardware is also included if you prefer a permanent installation for your full-time work truck.

- Removable center and rear cross bars to handle extra tall loads
- Fully adjustable for complete customization
- 800lbs weight capacity evenly distributed
- Manufactured from .120 wall 2" tubing
- Built-in air deflector to eliminate cab noise
- Built-in tie down anchor points
- Gusseted corners for extra strength
- Classic design with enhanced features
- Grade 8 hardware gold zinc plated included
- Textured matte black finish
- Shippable via UPS in two boxes

**LIFETIME**  
STRUCTURAL  
**5-YEAR** FINISH  
WARRANTY

TEXTURED  
**TB**  
BLACK

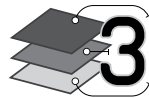

**3** STAGE TREATMENT  
• Dual stage powdercoating  
• Special "E-Coat" inside & out  
• Acid dipped to remove impurities

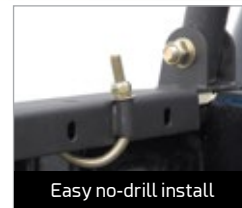

Easy no-drill install



Gusseted corners



Wind deflector eliminates cab noise



Removable rear cross bar

CONTRACTORS RACK	
DESCRIPTION	PART#
All Full-Size Truck Short /Long Bed	18604

## RUGGED RACK

When you're looking for extra space to haul your gear, look to Smittybilt to provide you with one of the largest SUV baskets available. Each rack attaches to the OE crossbars and can accommodate most of your Thule and Yakima accessories. The Rugged Rack is finished in a textured matte black and has the style needed to complement today's SUVs.

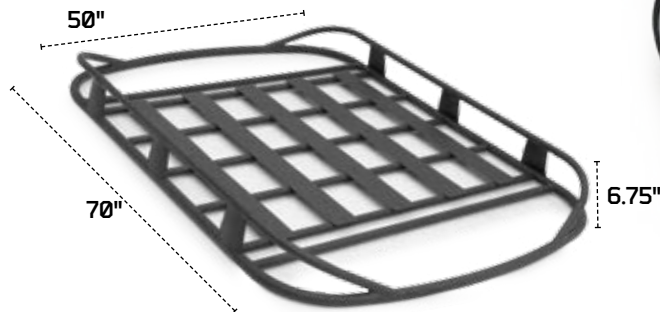

UNIVERSAL RUGGED RACK	
DESCRIPTION	PART#
Rugged Rack Basket (Universal)	17185

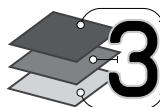

**3** STAGE TREATMENT  
• Dual stage powdercoating  
• Special "E-Coat" inside & out  
• Acid dipped to remove impurities

**LIFETIME**  
STRUCTURAL  
**5-YEAR** FINISH  
WARRANTY

TEXTURED  
**TB**  
BLACK





GET THE ORIGINAL

# CARGO MANAGEMENT

## ADVENTURE BOX

- Gas-charged struts for assisted opening
  - Precision manufactured of 16-gauge steel
  - Spring-loaded D-ring anchor points on top and side of tactical box
  - Ergonomic side carrying handles provided
  - EPDM rubber gaskets to keep items inside dry
  - Hardware included for securing tactical box to flat surfaces
  - Lockable storage system
  - Convenient large opening top lid for quick access
  - Front drawer system to quickly access and organize smaller items
  - Durable semi-gloss black powdercoat
  - Dimensions: 46" x 16" x 16"
  - Fits under Tonneau cover
- NOTE: Small drawer is not waterproof



D-Ring anchor points



Gas charged struts



Ergonomic side handles



DESCRIPTION	PART#
Adventure Box	18605

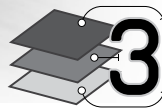

3 STAGE TREATMENT

- Dual stage powdercoating
- Special "E-Coat" inside & out
- Acid dipped to remove impurities

LIFETIME STRUCTURAL 5-YEAR FINISH WARRANTY

TEXTURED TB BLACK

## G.E.A.R. UNIVERSAL TRUCK SEAT COVER

- 600D polyester with PVC liner
- Completely adjustable
- Includes six MOLLE/PALS pouches of various sizes which will stay secured under the harshest off road conditions
- Sold in pairs



DESCRIPTION	COLOR	PART#
G.E.A.R. Universal Seat Cover	Black (01)	5661301
G.E.A.R. Universal Seat Cover	Tan (24)	5661324
G.E.A.R. Universal Seat Cover	Green (31)	5661331



## TRUCK TIE DOWN

- 3/16" cold rolled steel
- Seven anchor points per rail
- Secure multiple items in bed
- Multiple leveraging anchor points secures bulky items
- Low profile design
- High strength Grade 8 hardware
- All hardware included, some drilling required
- Kit contains two tie downs and two straps
- Can be used on front or rear of bed



DESCRIPTION	PART#
Truck Tie Down Anchor Kit	18603

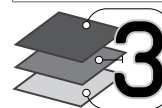

3 STAGE TREATMENT

- Dual stage powdercoating
- Special "E-Coat" inside & out
- Acid dipped to remove impurities

LIFETIME STRUCTURAL 5-YEAR FINISH WARRANTY

TEXTURED TB BLACK



## JERRY GAS CAN HOLDER

- Holds 5-gallon steel Jerry can
- Full metal construction for rugged use and abuse
- Store extra gas for emergency or increase your range
- Lockable top strap to prevent theft
- Universal mounting options
- Powdercoated for long lasting corrosion resistance



NOTE: Fits National-style Jerry Can. Does not fit cans with lip

DESCRIPTION	PART#
Jerry Gas Can Holder	2798

## RATCHET STRAP

- Padded grip ratchet tie downs
- 1-1/4" wide x 15' long
- PES webbing material
- WLL 500lbs
- Plastic coated double J-hooks



DESCRIPTION	PART#
Ratchet Tie Down Set (Pair)	18602

## 2" RECEIVER RACK

- 20" x 60" platform
- Mounts to any 2" receiver hitch
- All steel construction for durability
- Carries up to 500 lbs.- evenly distributed
- Powdercoat finish for long life



DESCRIPTION	PART#
Universal 2" Receiver Rack	7700





- Custom designed to fit your vehicle
- Aerodynamic design and reinforced corners
- Exclusive marine grade pressed textured diamond vinyl
- All weather sealing system – worry about the road not your valuables
- Truss (bow design) to prevent water/snow accumulation
- 6061 aircraft aluminum frame
- Durable ballistic nylon straps
- Nylon reinforced plastic buckles won't break or shatter
- Cargo net keeps your load secure
- Sleek, low profile look, improves gas mileage
- Ability to drop tailgate with tonneau on, improves security
- Fulcrum hinge system allows cover to roll back effortlessly
- Cam D speed lock-system makes installation or removal fast and easy
- Comes completely assembled - attach/detach in less than 3 minutes
- No drilling required



YEAR	PART#	DESCRIPTION	PART#
07-13	Chevy/GMC	Silverado/Sierra 6.5' Bed	2610031
14-18	Chevy/GMC	Silverado/Sierra 6.6' bed	2610032
07-13	Chevy/GMC	Silverado/Sierra 5.8' Bed	2620011
99-07	Chevy/GMC	Silverado/Sierra 6.5' Short Bed	2610011
04-07	Chevy/GMC	Silverado/Sierra Crew Cab 5.7'	2610021
14-18	Chevy/GMC	Silverado/Sierra 5.8' bed	2620012
09-18	Dodge	Short Bed - No built-in box 5.7' Bed	2620021
09-18	Dodge	Short Bed 1500 6.4' Bed	2620031
09-18	Dodge	Short Bed 2500	2620041
02-08	Dodge	Short Bed include Mega Cab	2630011
04-08	Ford	Super Crew 5.5 Bed	2630021
09-18	Ford	Super Crew 5.5 Bed	2630031
99-18	Ford	Super Duty 6.5 Short Bed	2630041
05-15	Toyota	Tacoma 5' Bed	2640011
16-18	Toyota	Tacoma 5' Bed	2640071
05-15	Toyota	Tacoma 6' Bed	2640021
16-18	Toyota	Tacoma 6' Bed	2640081
07-13	Toyota	Tundra 5.5' Bed	2640032
14-18	Toyota	Tundra 5.5' Bed	2640031
07-13	Toyota	Tundra 6.5' Bed	2640041
14-18	Toyota	Tundra 6.5' Bed	2640042
16-18	Nissan	Titan 5.5' Crew Cab	2650021
16-18	Nissan	Titan 6.5' Crew Cab	2650031

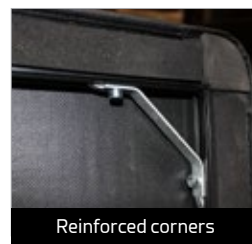





**SMITTYBILT**

GET THE ORIGINAL



*"My husband was hit head-on by a car at 70mph. Had it not been for your well-built XRC bumper and winch, my husband would be dead. Thank you, Smittybilt!"*

*– Charlotte B., Veneta, Oregon*

## JEEP ACCESSORIES

PICTURED: ATLAS BUMPER (SEE FOLLOWING PAGE)



## JK BUMPERS



**XRC GEN2**  
Aggressive stubby bumpers for extreme rock crawling. [Page 30](#)



**SRC GEN2**  
Maximum protection under extreme conditions. [Page 34](#)



**ATLAS**  
Worldwide favorite with stylish looks [Page 28](#)



**TOX MODULAR BUMPER**  
Sleek modular bumper lets you go winch or winchless. [Page 39](#)



**M.O.D.**  
Multi-Optional Design lets you custom build a bumper [Page 39](#)



**XRC GEN 1**  
Provides increased clearance for rock crawling. [Page 40](#)



**SRC CARBINE**  
A limited budget doesn't mean limited capability. [Page 44](#)



**SRC ULTRA CLASSIC**  
Smittybilt's first rock crawler bumper is still a favorite. [Page 47](#)



**TUBULAR**  
The highest quality tubulars on the market. [Page 49](#)



**SRC STINGER**  
Maximum clearance for approach and departure angles. [Page 45](#)

## TJ, LJ, YJ, CJ BUMPERS



**XRC**  
Increased clearance for extreme terrain. [Page 41](#)



**SRC**  
Fender-to-fender protection for on or off-road. [Page 46](#)



**SRC STINGER**  
Maximum clearance for approach and departure angles. [Page 45](#)



**SRC CLASSIC**  
Classic rock crawler design for old school aficionados. [Page 48](#)



**TUBULAR**  
The highest quality tubulars on the market. [Page 49](#)

## XJ BUMPERS



**XRC**  
Fender-to-fender protection for on or off-road. [Page 42](#)





**SMITTYBILT**

GET THE ORIGINAL



**ATLAS**

#### ATLAS BUMPERS

The Smittybilt Atlas bumpers have gone through extensive design and testing to meet stringent international pedestrian safety standards. As a result, these bumpers are extremely strong and functional as well as being stylishly chiseled. The rear bumper utilizes a new cam-style pin adjustment for ensuring perfect gate stowing every time. Re-opening the gate requires minimal effort and the double latch will eliminate accidental opening.





**INNOVATIVE  
4-PIECE  
DESIGN**

- A** Bull Bar
- B** Winch Plate
- C** Skid Plate
- D** Atlas Bumper

## ATLAS – FRONT BUMPER

- Innovative 4-piece design
- 3/16" cold rolled steel
- Lower design winch plate allows greater airflow
- 6x4.5 and 10x4.5 winch bolt patterns
- Bolt-on skid plate and bull bar
- Fits up to 12k winch
- Light holes allow use of OE fog lights
- Solid mount D-rings - welding on the inside and out
- Light mounting tabs on bull bar
- Stylish bumperette with Atlas badging
- Marine grade stainless steel hardware
- Two stage textured matte black powdercoat finish

NOTE: Optional winch and lights sold separately

## ATLAS – REAR BUMPER

- 3/16" cold rolled steel
- Rear swing away design
- Cam-style pin adjustment, billet cover
- MOLLE/PAL compatible
- Antenna and jack mount (trail jack sold separately)
- Easy opening double latch
- Accomodates up to 40" tire
- Solid mount D-rings - welding on the inside and out
- Class III hitch
- Gas can holder accepts Model 5800 or similarly sized gas cans (can optional)

### MATCHING ACCESSORIES:

Atlas Rock Sliders on page 50

Atlas Body Steps on page 100



ATLAS BUMPER		
YEAR	MODEL	PART#
07-18	Wrangler JK 2/4-Dr -Front	76892
07-18	Wrangler JK 2/4-Dr - Rear	76896





**SMITTYBILT**

GET THE ORIGINAL



*"I love my XRC bumpers, SRC rocker guards and 8k Winch from Smittybilt - Great products!"  
- O. Carattini, San Marco, CA*





# XRC GEN2

## XRC GEN2 BUMPERS

The new XRC Gen2 bumpers have been completely redesigned with more aggressive styling and heavy duty features, giving you the ultimate performance for rock crawling. These stubby bumpers provide increased clearance and have angled corners for more aggressive approach angles in extreme conditions – perfect for vehicles running oversized tires.

The redesigned solid D-ring and jack point mounts are welded on the inside and out, and feature an integrated recovery point for easy access. This new bumper also allows the use of the OE fog lights. The winch plate has been placed lower for greater airflow to the radiator, while the new overrider is 1.75" diameter and has integrated mounts for additional lighting. The modular nature of the rear bumper allows you to add a bolt-on tire carrier to the bumper (#76857). The XRC Gen2 is also available in the new Light Texture finish. See the following pages for details on the entire line.





# XRC GEN2 JK FRONT



Max solid D-ring and jack point mount welded on the inside and out!



**AGGRESSIVE, STUBBY DESIGN.**  
 Raised corners for better entry and exit angles in extreme conditions



Light mount tabs for lights up to 9 inches in diameter

OE fog light ports (Lights not included)

1.75" .120 wall kickers offer fender-to-fender coverage

Ability to accommodate up to 12k winch. Comes with both 6x4.5 and 10x4.5 bolt patterns

Two-stage textured matte black finish (also available in new Light Texture)



PP+TPO slip strips – the ultimate for rock crawling, provides 5/16" additional damage protection

Manufactured from 3/16" cold rolled steel

XRC GEN2 BUMPER		
MODEL	DESCRIPTION	PART#
07-18 JK 2/4 Dr	XRC Gen2 Front Bumper	76807
07-18 JK 2/4 Dr	XRC Gen2 Front Bumper Light Texture	76807LT
Replacement slip strips - Front Bumper		76807-01



## NEW LIGHTTEXTURE

Smittybilt has added a modern new look to their line. Look for the "LT" logo for products that are available in the sleek new Light Textured finish.

- XRC Gen2 Front/Rear Bumpers (p. 32-33)
- XRC Gen2 Tire Carrier (p. 33, 37)
- SRC Side Armor with Step - JK (p. 56)
- SRC Rocker Guard with Plate - JK (p. 56)
- Atlas Rock Sliders w/Step – JK (p. 55)

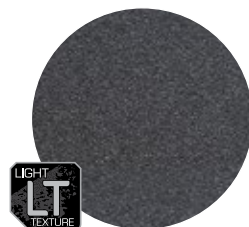

New Light Textured Finish

Original Matte Textured Black Finish





**AGGRESSIVE,  
STUBBY DESIGN.**  
Raised corners for better entry and exit angles in extreme conditions



- Auxiliary back up light cutouts – LED lights included
- Class III hitch with anti-rattle provision 500lb tongue, 5,000 GTW
- Manufactured from 3/16- inch cold rolled steel
- Optional bolt-on tire carrier mounting location
- Max solid D-ring and jack point mount welded on the inside and out!
- PP+TPO slip strips – The ultimate protection for rock crawling
- Two-stage textured matte black finish (also available in new Light Texture)



XRC GEN2 BUMPER		
MODEL	DESCRIPTION	PART#
07-18 JK 2/4 Dr	XRC Gen2 Rear Bumper	76858
07-18 JK 2/4 Dr	XRC Gen2 Rear Bumper Light Texture	76858LT
	Replacement slip strips - Rear Bumper	76858-01
	Replacement rear LED lights	612800-04



## XRC GEN2 BOLT-ON TIRE CARRIER

- Bolt-on design tire carrier
- 40" Max, Up to 37" tire recommended
- Fits SRC, XRC and factory Tenth Anniversary Jeep® bumpers

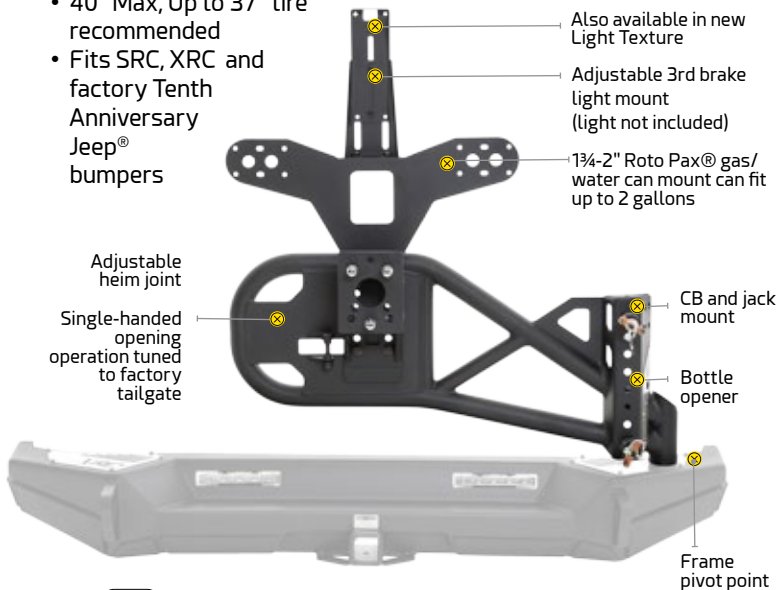

- Also available in new Light Texture
- Adjustable 3rd brake light mount (light not included)
- 1¾-2" Roto Pax® gas/ water can mount can fit up to 2 gallons
- CB and jack mount
- Bottle opener
- Frame pivot point



GEN2 BOLT-ON TIRE CARRIER		
DESCRIPTION	PART#	
07-18 JK 2/4 Door	76857	
07-18 JK 2/4 Door Light Texture	76857LT	
Jeep Tenth Anniversary Bumper Mounting Kit	76857-01	





**SMITTYBILT**

GET THE ORIGINAL



**SRC**  
GEN2

### **SRC GEN2 BUMPERS**

The SRC Gen2 bumpers have been completely redesigned for greater fender-to-fender protection. Manufactured from 3/16" cold rolled steel, the bumpers feature corners that extend to match the factory fender lines. The raised corners allow for better entry and exit angles in extreme conditions.

The bottom and sides have been reinforced with replaceable PP+TPO slip strips, which provides an extra 5/16" of damage protection. The redesigned solid D-ring mounts are welded in the inside and out and feature an integrated recovery point for easy access. Each rear bumper features two bright 6" LED lights and a class III, 2" receiver hitch that is incorporated into the bumper and bolts directly up to your factory mounting points. The modular nature of the bumper allows you to add a bolt-on carrier that fits up to a 40" tire and can be easily opened and closed with one hand. See the following pages for details on the entire line.









GET THE ORIGINAL

# SRC GEN2 JK FRONT



Ultimate fender-to-fender protection with override that matches your factory fender line



**FENDER-TO-FENDER PROTECTION.**  
Integrated override extends to match factory fender line

XRC GEN2 BUMPER		
MODEL	DESCRIPTION	PART#
07-18 JK 2/4 Dr	SRC Gen2 Front Bumper	76724
	Replacement slip strips - Front Bumper	76724-01

**3 STAGE TREATMENT**  
 • Dual stage powdercoating  
 • Special "E-Coat" inside & out  
 • Road dipped to remove impurities

**LIFETIME WARRANTY**  
 5 YEAR FINISH WARRANTY

**TB**  
 TUBULAR

Light mount tabs for lights up to 9 inches in diameter

Manufactured from 3/16" cold rolled steel

OE fog light ports (Lights not included)

Ability to accommodate up to 12k winch. – comes with both 6x4.5 and 10x4.5 bolt patterns

Two-stage textured matte black finish (also available in new Light Texture)

Max solid D-ring and jack point mount welded on the inside and out!

1.75" .120 wall kickers offer fender-to-fender coverage

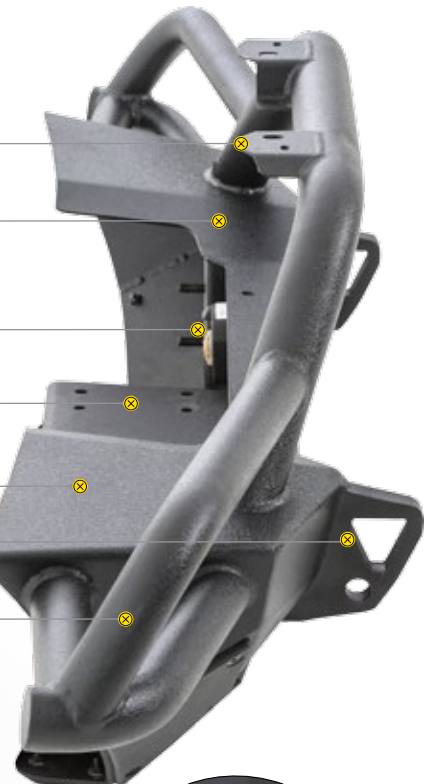

PP+TPO slip strips – the ultimate for rock crawling, provides 5/16" additional damage protection







**SRC GEN2**  
**FENDER-TO-FENDER PROTECTION.**  
 Integrated override extends to match factory fender line

- Manufactured from 3/16-inch cold rolled steel
- Class III hitch with anti-rattle provision 500lb tongue, 5,000 GTW
- Two-stage textured matte black finish
- Optional bolt-on tire carrier mounting location
- Max solid D-ring and jack point mount welded on the inside and out!
- Auxiliary back up light cutouts - LED lights included
- Ultimate fender-to-fender protection with override that matches your factory fender line
- PP+TPO slip strips - the ultimate for rock crawling, provides 5/16" additional damage protection

OPTIONAL

INCLUDED

612800-04

Optional Accessories: SRC Gen2 Rear Bumper with XRC Tire Carrier (below), Slant Hard Top (page 75) and Slant Tire Carrier Adapter Kit (page 51)

XSRC GEN2 BUMPER		
MODEL	DESCRIPTION	PART#
07-18 JK 2/4 Dr	SRC Gen2 Rear Bumper	76614
	Replacement slip strips - Rear Bumper	76614-01
	Replacement rear LED lights	612800-04

3

**STAGE TREATMENT**

- Dual stage powdercoating
- Special "E-Coat" inside & out
- Rid dipped to remove impurities

**LIFETIME**  
STRUCTURAL  
**5-YEAR** FINISH  
WARRANTY

**TEXTURED**  
**TB**  
BLACK

### XRC GEN2 BOLT-ON TIRE CARRIER

- Bolt-on design tire carrier
- 40" Max, Up to 37" tire recommended
- Fits SRC, XRC and factory Tenth Anniversary Jeep® bumpers

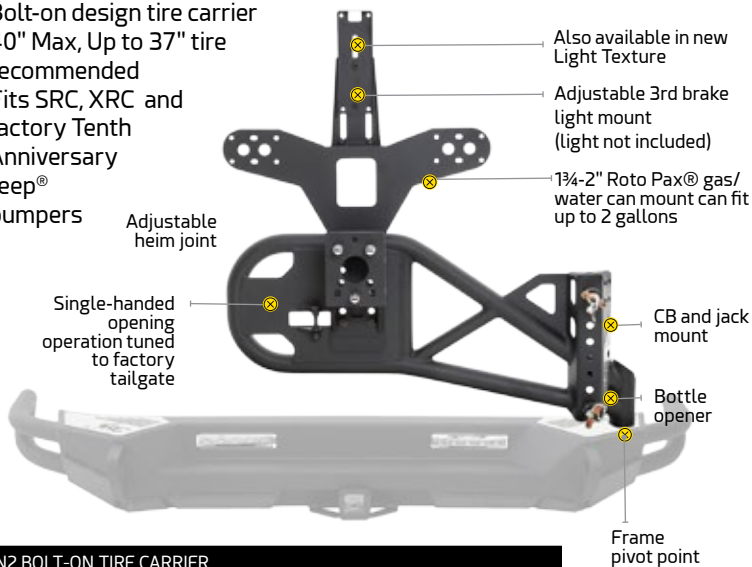

GEN2 BOLT-ON TIRE CARRIER	
DESCRIPTION	PART#
07-18 JK 2/4 Door	76857
07-18 JK 2/4 Door Light Texture	76857LT
Jeep Tenth Anniversary Bumper Mounting Kit	76857-01

3

**STAGE TREATMENT**

- Dual stage powdercoating
- Special "E-Coat" inside & out
- Rid dipped to remove impurities

**LIFETIME**  
STRUCTURAL  
**5-YEAR** FINISH  
WARRANTY

**TEXTURED**  
**TB**  
BLACK







# 10X MODULAR BUMPER JK



Shown with wings removed



## 10X MODULAR BUMPER

The NEW Smittybilt 10x Modular Bumper was inspired by the 10th Anniversary Wrangler Rubicon but can fit on any JK. The modular features allows you to install a winch (up to 12k) or go winchless when needed. Wings can be added for a sleek, streamlined look or can be removed to become an aggressive stubby bumper.

### FRONT BUMPER

- Includes center base bumper, wings, winch plate, winch plate cover, fairlead cover and hooks
- Heavy gauge, 3mm stamped steel and internal gussets for superior strength
- Heavy duty winch plate included – compatible with most winches up to 12k
- Recessed winch mounting location does not restrict engine cooling
- Modular design – center base is aggressive, stubby bumper. Wings, winch cover plate and fairlead cover can be affixed for a sleek, winchless look
- Red factory-style tow hooks included
- Removeable shackle mounts included (Note: not compatible with mid-2012 and earlier JKs)
- Provision included for OEM anniversary fog lights
- Airbag compatible

### REAR BUMPER

- Low profile design for addition clearance
- Works with Smittybilt XRC Gen2 Tire Carrier (#76857/76857LT)
- Surface cap (not shown) gives rear bumper a sleek appearance when tire carrier is not in use
- Compatible with the factory receiver hitch and OEM tow hooks

### 10X ANNIVERSARY BUMPER

YEAR	MODEL	DESCRIPTION	PART#
07-18	Wrangler JK	Front Bumper	76747
07-18	Wrangler JK	Rear Bumper	74748



10x Modular Bumper base only



winch sold separately

10x Modular Bumper with winch



10x Modular Bumper with Wings



winch sold separately

10x Modular Bumper complete set-up



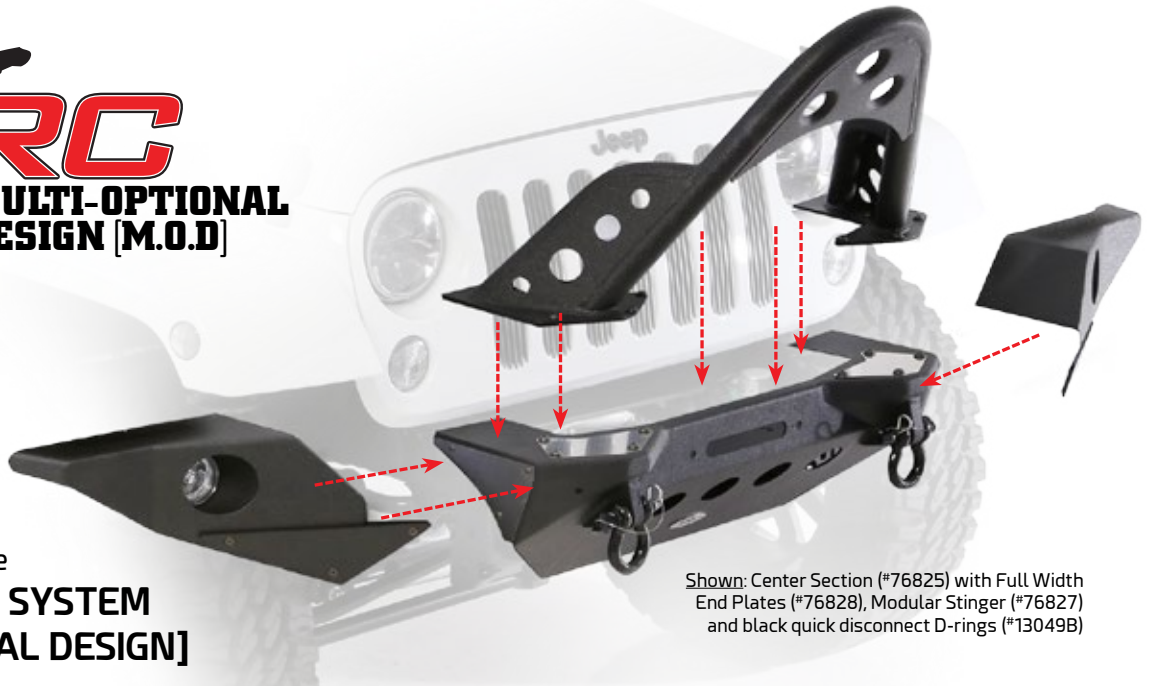

Custom-build your own bumper with the **M.O.D. BUMPER SYSTEM [MULTI OPTIONAL DESIGN]**

Shown: Center Section (#76825) with Full Width End Plates (#76828), Modular Stinger (#76827) and black quick disconnect D-rings (#13049B)

Smittybilt appreciates that Jeep owners want to customize their vehicles to fit their specific needs. This was the inspiration behind the Smittybilt XRC M.O.D. bumpers for 07+ Jeep Wrangler JKs. The base unit was developed around our XRC platform and comes standard with a high-capacity winch cradle and D-ring mounts that provide a towable anchor point. What you do from there is up to you. The ends can be left bare to optimize approach angle, or you can add stylish end plates to protect your fenders. They can be easily bolted and unbolted to create a whole new look in minutes.

- Manufactured from 3/16" cold rolled steel
- Solid mount D-rings - welds on the inside and out
- Multi-piece options allow you to build your bumper in any configuration for any situation
- Built-in plate to accommodate up to 15k winch
- 6x4.5 and 10x4.5 winch bolt patterns
- Marine grade stainless steel hardware



*"I love my XRC MOD Bumper system! It's quality made and it just looks amazing!"*  
 – R. Castle, Houston, TX

XRC M.O.D. SYSTEM			
YEAR	MODEL	DESCRIPTION	PART#
07-18	Wrangler JK	Modular Center Section	76825
07-18	Wrangler JK	Mid-Width End Plates	76826
07-18	Wrangler JK	Modular Stinger	76827
07-18	Wrangler JK	Full-Width End Plates (lights included*)	76828
07-18	Wrangler JK	Modular Bull Bar	76829
07-18	Wrangler JK	Crawler End Plate	76830
07-18	Wrangler JK	Brush Guard	76821
Replacement bulb for Full-Width End Plate lights			612800-05

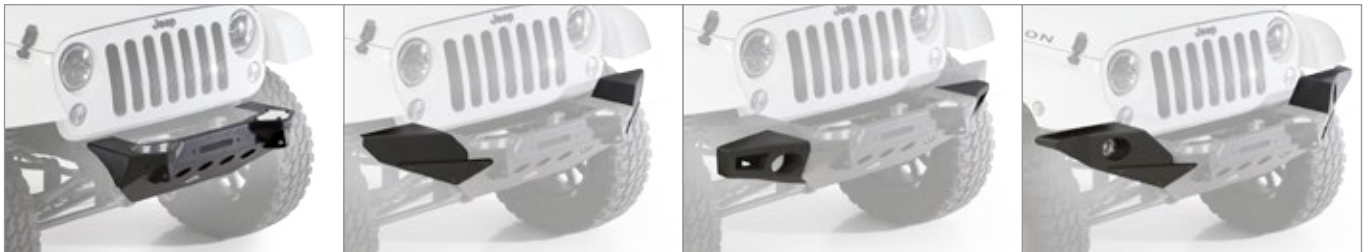

XRC Base

Mid-Width End Plates

Crawler End Plates

Full-Width End Plates w/Lights

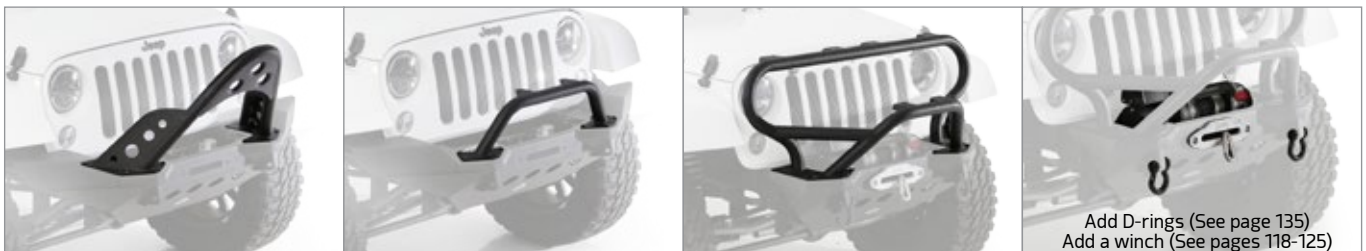

Modular Stinger

Modular Bull Bar

Brush Guard

Add D-rings (See page 135)  
 Add a winch (See pages 118-125)  
 Additional Accessories





GET THE ORIGINAL

# XRC GEN 1 CLASSIC JK



## GEN 1 CLASSIC



76806 Front Bumper



Raised corners for better entry/exit angles

Up to 12k winch

Solid D-ring mounts welded inside and out

76856 Rear Bumper w/Swing Away

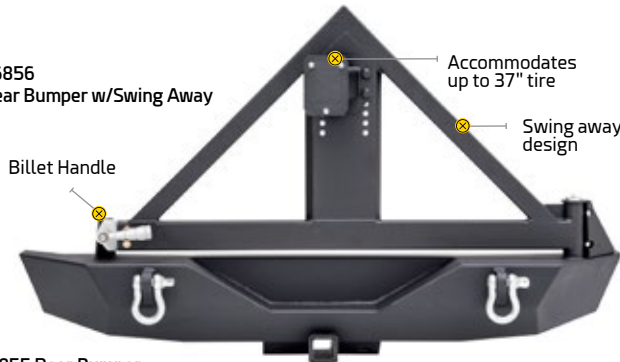

Billet Handle

Accommodates up to 37" tire

Swing away design

76855 Rear Bumper



Class III 2" receiver hitch

Solid D-ring mounts welded inside and out

### XRC GEN1 CLASSIC FOR JK

#### FRONT BUMPER

- Manufactured from 3/16" cold rolled steel
- Includes winch plate for up to 12k winch and D-rings
- New solid D-ring mount - welded on the inside and out
- One-piece welded design
- 2.0" 120 wall overrider and kickers
- Raised corners for better entry/exit under most extreme conditions
- Solid plate center section wraps frame horns and lower crossmember
- Built-in winch plate to accommodate up to a 15k winch

#### REAR BUMPER

- Manufactured from 3/16" cold rolled steel
- New solid D-ring mount - welded on the inside and out
- One-piece welded design
- Class III 2" receiver hitch
- Solid billet aluminum handle with built-in cam lock
- Adjustable tire mount that accommodates up to a 37" tire
- Swing Away includes third brake light bracket



3 STAGE TREATMENT

- Dual stage powdercoating
- Special "E-Coat" inside & out
- Acid dipped to remove impurities



XRC GEN1 CLASSIC			
YEAR	MODEL	DESCRIPTION	PART#
07-18	Wrangler JK 2/4-Dr	XRC Bumper - Front	76806
07-18	Wrangler JK 2/4-Dr	XRC Bumper - Rear	76855
07-18	Wrangler JK 2/4-Dr	XRC Bumper - Rear w/ Swing Away	76856





76801 Front Bumper



Raised corners for better entry/exit angles

Up to 12k winch

76654 Bolt-on Rear Swing Away

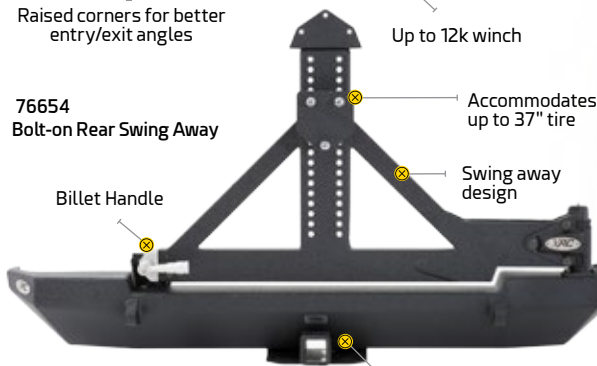

Accommodates up to 37" tire

Swing away design

Billet Handle

76653 Rear Bumper



Class III 2" receiver hitch

Class III 2" receiver hitch

Solid D-ring mounts welded inside and out



**XRC FOR TJ, LJ, YJ, CJ**

**FRONT BUMPER**

- Heavy-duty bumpers designed for off-road use and abuse
- Sloping ends for greater tire travel and enhanced entry and exit points
- Manufactured from 3/16" cold rolled steel
- 3/16" solid plate center section
- Durable powdercoat painted 2" x .120" wall overrider
- One-piece welded design
- Solid D-ring mounts are welded on the inside and out
- Overrider has two light mount tabs can hold up to 7" round lights
- Wide front opening accommodates up to 12,000 lb winch

**REAR BUMPER**

- Manufactured from 3/16" cold rolled steel
- Rear bumper has Class III 2" receiver hitch, rated 5,000 lbs
- One-piece welded design
- Solid D-ring mounts are welded on the inside and out
- Optional bolt-on rear Swing Away tire carrier available
- Tire carrier has adjustable spare tire mount (up to 37") and 1/4" steel plate design

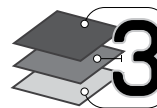

**3 STAGE TREATMENT**

- Dual stage powdercoating
- Special "E-Coat" inside & out
- Acid dipped to remove impurities

**LIFETIME STRUCTURAL 5-YEAR FINISH WARRANTY**

**TEXTURED TB BLACK**

\* For use with 76800 only

>> \*D-Rings sold separately.



Heavy-duty latch mechanism keeps your tire secure



The Swing Away Rack w/ a built-in safety catch

**XRC GEN1 BUMPERS FOR TJ, LJ, YJ, CJ**

YEAR	MODEL	DESCRIPTION	PART#
87-95	Wrangler (YJ)	Front Bumper	76801
97-06	Wrangler (TJ,LJ)	Front Bumper	76800
76-86	Wrangler (CJ)	Front Bumper Adapter	2812*
87-06	Wrangler (YJ,TJ,LJ) Unltd.	Rear Bumper	76653
87-06	Wrangler (YJ,TJ,LJ) Unltd	Bolt-on Rear Swing Away	76654





**SMITTYBILT**

GET THE ORIGINAL



**XRC**

### **XRC** BUMPERS FOR XJ

Smittybilt offers a complete lineup of accessories for your XJ. Front and rear bumpers are designed for maximum clearance for off-roading without major modifications to your vehicle. We also offer a complete line of side protection that enhances and protects your vehicle.





## XRC BUMPERS FOR XJ

- Heavy-duty bumpers designed for off-road abuse
- Sloping ends for greater tire travel and enhanced entry and exit points
- Manufactured from 3/16" cold rolled steel
- One-piece welded design with two jack mount points on both front and rear
- Solid D-ring mounts are welded on the inside and out
- Accommodates up to 12,000 lb winch with 6x4.5 or 10x4.5 winch bolt patterns
- Optional bolt-on 2" x .120" wall Bull Bar (#76811) and Stinger available (#76812)
- Rear bumper available with Swing-Away tire carrier (#76851) or without (#76850)
- Class III 2" receiver hitch, rated 5,000 lbs
- Stylish and practical rear fender cladding included
- Carrier has cam-style pin adjustment and can fit up to 37" tire
- Rear gas can holder accepts Model 5800 or similarly sized gas cans (can not included)
- Matching XRC Body Cladding (pg. 54) and Rock Sliders (pg 54) also available

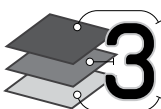

**3 STAGE TREATMENT**  
 • Dual stage powdercoating  
 • Special "E-Coat" inside & out  
 • Acid dipped to remove impurities

**LIFETIME STRUCTURAL 5-YEAR FINISH WARRANTY**

**TEXTURED TB BLACK**

XRC - XJ BUMPERS		
YEAR	DESCRIPTION	PART #
84-01	XJ XRC Front Bumper	76810
84-01	XJ XRC Bull Bar only	76811
84-01	XJ XRC Stinger only	76812
84-01	XJ XRC Rear Bumper w/ Rear Fender Cladding*	76850
84-01	XJ XRC Rear Bumper w/ Tire Carrier*	76851

\* Will not work with shackle drop brackets





**SMITTYBILT**

GET THE ORIGINAL

# SRC CARBINE JK



## SRC CARBINE BUMPER

A limited budget doesn't have to mean limited capability. The all new Carbine bumper offers Smittybilt's renowned rugged construction while at the same time letting the cost-conscious or entry level jeeper play with the big boys. Manufactured from 3/16" cold-rolled steel and finished with the signature two-stage, textured black finish, the Carbine is fully backed by the Smittybilt Advantage Warranty.

Open top and side design fits virtually all winch sizes



**3 STAGE TREATMENT**

- Dual stage powdercoating
- Special "E-Coat" inside & out
- Acid dipped to remove impurities

**LIFETIME STRUCTURAL WARRANTY**

**5-YEAR FINISH WARRANTY**

**TEXTURED TB BLACK**

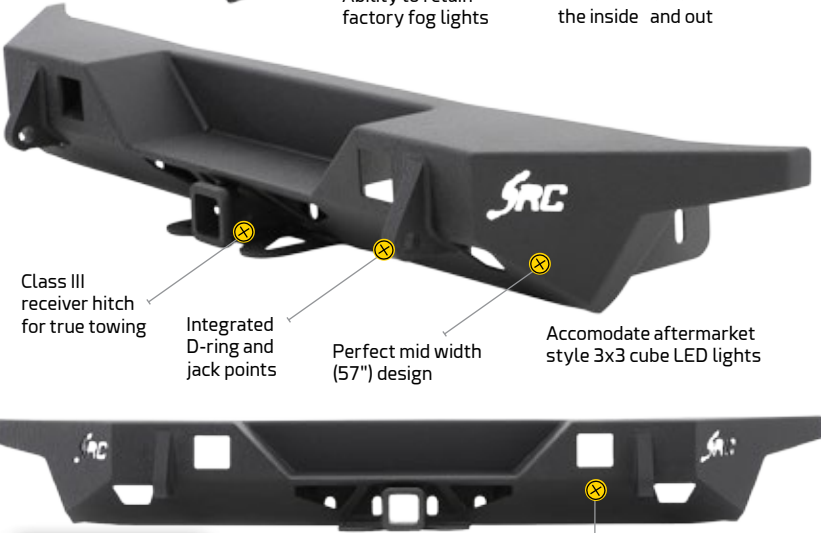

SRC CARBINE BUMPER			
YEAR	MODEL	DESCRIPTION	PART#
07-18	Wrangler JK	Front Bumper	76744
07-18	Wrangler JK	Rear Bumper	76745

**SMITTYBILT**  
NEW PRODUCT





**SRC FRONT STINGER**

- The Stinger is manufactured from 2" DOM 120, wall Tubing - One of the strongest materials
- The base plate is manufactured 3/16" cold rolled steel and integrated D-Ring mounts
- D-Rings are welded inside and out to make it the strongest mount out there
- Reinforced corners and sides for added strength
- Can be used with various winch plates, for TJ model
- Provides the maximum clearance for approach and departure angles
- Deflective angles are designed to protect the hood in a roll-over
- Smittybilt Advantage Warranty



SRC - STINGER FRONT/REAR BUMPERS			
YEAR	MODEL	DESCRIPTION	PART#
87-06	Wrangler (TJ,YJ)	Front Stinger	76521
07-18	Wrangler (JK) 2/4-DR	Front Stinger	76524

 Will not work with front bumper adapter for Jeep CJ # 2812



**3** STAGE TREATMENT

- Dual stage powdercoating
- Special "E-Coat" inside & out
- Acid dipped to remove impurities

**LIFETIME**  
STRUCTURAL  
**5-YEAR** FINISH  
WARRANTY

TEXTURED  
**TB**  
BLACK





# SRC GEN1 TJ YJ CJ



76621

Wide opening allows for winch installation

4 light mounting tabs

**NOTE: Front bumper requires Winch Plate (#2803)**

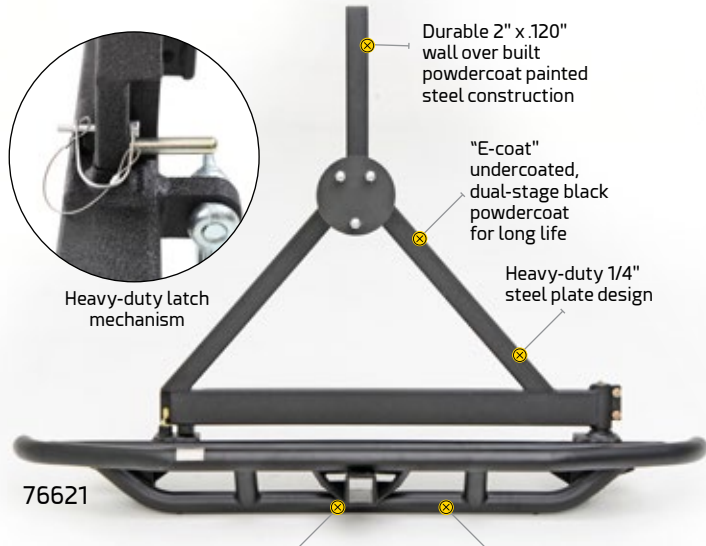

76621

Class III 5,000 lbs rated hitch capacity

More ground clearance



76611

Class III 5,000 lbs rated hitch capacity

More ground clearance



## SRC GEN1 FOR TJ / YJ / CJ

These heavy-duty bumpers are designed for off-road use and abuse. Durable powdercoat painted 2" x .120" wall tube protects your front end from those large rocks or boulders. Each bumper has sloping ends for greater tire travel and enhanced entry and exit points. Just like the front, each rear bumper has a 3/16" solid plate center section which is designed to contour around an oversized tire to give you the maximum tire clearance when opening and closing your tailgate. Each rear bumper features a class III, 2" receiver hitch that is incorporated into the bumper and bolts directly up to your OE points. Includes two D-ring mounts for those sticky situations (D-rings sold separately)

- Manufactured from 2" x .120 wall tube
- Solid mount D-rings – welded on the inside and out!
- One-piece welded design
- Class III 2" receiver hitch
- Two Stage Matte Black Texture Finish Powdercoat
- Smittybilt Advantage Warranty

**3** STAGE TREATMENT

- Dual stage powdercoating
- Special "E-Coat" inside & out
- Acid dipped to remove impurities

**LIFETIME**  
STRUCTURAL  
**5-YEAR**  
FINISH  
WARRANTY

**TEXTURED**  
**TB**  
BLACK

SRC - BUMPER (Front)			
YEAR	MODEL	DESCRIPTION	PART#
87-06	Wrangler	SRC Bumper - Front	76721
76-86	CJ	SRC CJ Bumper Adapter - Front	2812
87-06	Wrangler TJ/YJ	SRC Bumper - Rear	76611
87-06	Wrangler TJ/YJ	SRC Bumper w/ Tire Carrier - Rear	76621



# SRC ULTRA CLASSIC

## ULTRA CLASSIC BUMPERS FOR JK

The SRC Ultra Classic line provides style and strong characteristics to the front of your Jeep®. All of our classic bumpers have the proper approach angles which are needed in the rock crawling world. Each bumper is manufactured from 3/16" plate and will provide you the maximum protection for any situation that you can get yourself into.

All Ultra Classic front bumpers are available with D-rings and the 2007-2018 Wrangler bumper is offered with or without a winch mount.

- One-piece welded design
- Direct bolt-on with minimal modifications required
- Front bumper features two light tabs to hold up to a pair of 9" lights
- Comes with or without winch plate (6x4.5 and 10x4.5 winch bolt patterns)
- Integrated winch mount holds up to a 15,000 lb rated line pull winch



76743



SRC Classic Sides available for JKs – See page 54

SRC - ULTRA CLASSIC BUMPER (FRONT ONLY)			
YEAR	MODEL	DESCRIPTION	PART#
07-18	Wrangler JK	Ultra Classic Bumper w/Winch Plate	76743

**3 STAGE TREATMENT**

- Dual stage powdercoating
- Special "E-Coat" inside & out
- Acid dipped to remove impurities

**LIFETIME STRUCTURAL 5-YEAR FINISH WARRANTY**

**TEXTURED TB BLACK**





GET THE ORIGINAL

# SRC CLASSIC TJ LJ YJ



**CLASSIC BUMPER**  
Classic Rock Crawler design provides front end protection



76740-D  
Front Bumper  
shown with D-ring  
mounts and D-rings

76740  
Front Bumper  
shown without  
D-ring mounts

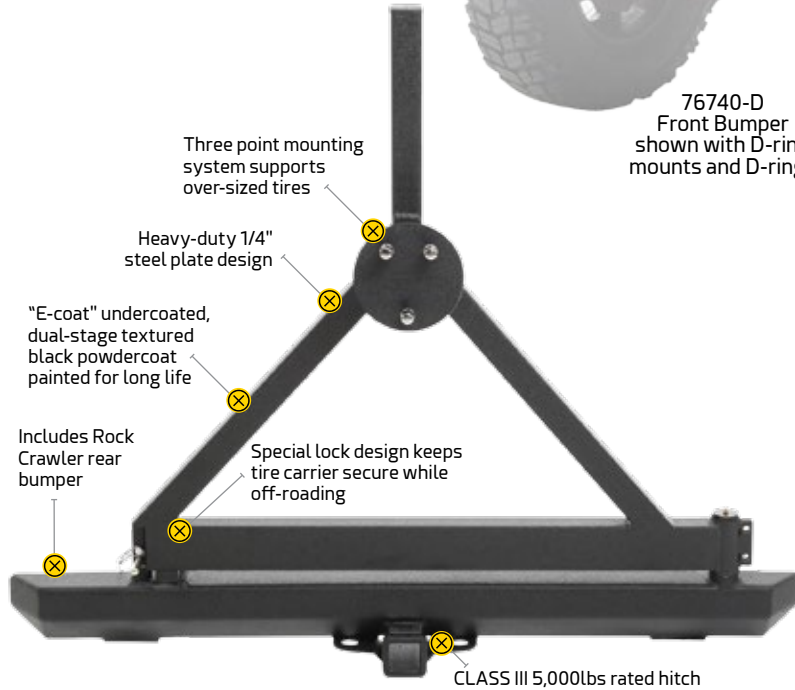

76751-D Shown with Tire Carrier, D-Ring mounts & D-rings



76750-D Shown with D-Ring mounts & D-rings



76750 Shown without D-Ring mounts & D-rings



Swing away allowing the use of your tailgate



Three point mounting system for oversized spare tire



Comes with or without D-ring mounts

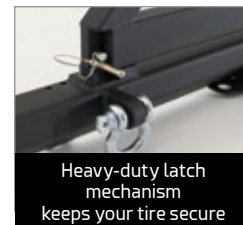

Heavy-duty latch mechanism keeps your tire secure



Custom grease fitting keeps hinge clean and smooth

SRC - CLASSIC BUMPERS			NO D-RING	D-RING
YEAR	MODEL	DESCRIPTION	PART#	PART#
76-06	Wrangler (TJ, YJ, LJ)	Classic Bumper - Front	76740	76740D**
76-06	Wrangler (TJ, YJ, LJ)	Classic Bumper - Rear w/o Tire Carrier	76750	76750D**
76-06	Wrangler	Classic Bumper - Rear w/ Tire Carrier	76651	76651D*

\* Includes D-Rings, requires adapter 3721 for CJ application • \*\* Includes D-Rings



3 STAGE TREATMENT  
• Dual stage powdercoating  
• Special "E-Coat" inside & out  
• Acid dipped to remove impurities







## TUBULAR BUMPERS

With three different finishes and multiple applications, Smittybilt offers the highest-quality tubular program on the market. Each front and rear bumper is robotically welded to exacting specifications to ensure long life and continued good looks. It is then specially treated with a dense zinc undercoating before being put through a dual powdercoat painted finish or triple chrome plating. The stainless version begins with the highest-quality virgin 304L stainless steel that is polished to a mirror finish. All Smittybilt tubular front bumpers have the signature look with pre-cut vertical uprights and come with or without hoop. Rear bumpers are available with a 2" square receiver hitch that has a 3500 lb. towing weight, 350 lb. tongue weight.

§ Not compatible with winch plates.  
Not compatible w/ most winch plates. TJ must lower fuel tank.



TUBULAR BUMPERS					
YEAR	MODEL	DESCRIPTION	GLOSS BLACK	STAINLESS STEEL	TEXTURED BLACK
76-06	Wrangler CJ, YJ, TJ	Front Bumper	JB44-FN	JB44-FNS	JB44-FNT
76-06	Wrangler CJ, YJ, TJ	Front Bumper w/Hoop	JB44-F	JB44-FS	JB44-FT
07-18	Wrangler JK 2/4-DR	Front Bumper w/Hoop	JB48-F	JB48-FS	JB48-FT
07-18	Wrangler JK 2/4-DR	Front Frame Cover	-	-	JB48CFT
87-06	Wrangler YJ, TJ	Rear Bumper	JB44-R	JB44-RS	JB44-RT
07-18	Wrangler JK 2/4-DR	Rear Bumper	JB48-R	JB48-RS	JB48-RT
87-06	Wrangler YJ, TJ	Rear Bumper w/hitch	JB44-RH	JB44-RHS	JB44-RHT
07-18	Wrangler JK 2/4-DR	Rear Bumper w/hitch	JB48-RH	JB48-RHS	JB48-RHT
07-18	Wrangler JK 2/4-DR	Rear frame cover	-	-	JB48CRT

ACCESSORIES	
DESCRIPTION	PART#
<b>A</b> 2" Factory Style Class IV Receiver Hitch Gloss black powdercoat, 07-18 JK 2/4 Door	JH45
<b>B</b> License Plate Bracket for all 3" Dual Tube Bumpers	4430
Replacement End Caps - Black (pair)	TA25
Replacement End Caps - Chrome (pair)	TA25C

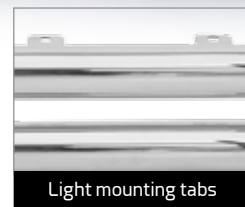
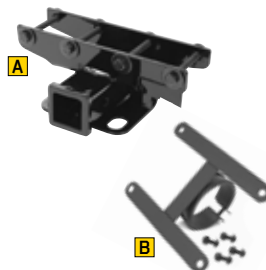





GET THE ORIGINAL

## TAILGATE / TIRE CARRIERS



**SMITTYBILT**  
NEW PRODUCT

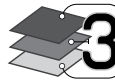

**3** STAGE TREATMENT  
• Dual stage powdercoating  
• Special "E-Coat" inside & out  
• Acid dipped to remove impurities

**LIFETIME**  
STRUCTURAL  
**5 YEAR**  
FINISH  
WARRANTY

**TEXTURED**  
**TB**  
BLACK



### XRC TAILGATE w/TIRE CARRIER

- Built-in, adjustable tire carrier eliminates need for factory or bumper tire carrier
- Tire carrier fits up to 37" tire and uses OE bolt configuration
- Cast steel hinge points and rigid, durable steel construction reduces sag
- 14 gauge steel outer skin with textured black finish
- Direct bolt-on - no drilling or cutting required
- Mounting holes for factory handle and latch
- Steps allow easy access to top, with integrated tie down points and bottle opener
- Stylish stainless steel badging on steps and hinge
- Integrated seal replaces factory vent location. Weather seals included
- Weighs only 100 lbs
- Can be installed with any Smittybilt bumper or accessory, as well as factory bumper
- Pre-drilled holes for Smittybilt G.E.A.R. Tailgate Cover (#56623XX) and Tailgate Table (#2793)



XRC - TAILGATE		
YEAR	MODEL	PART#
07-18	Wrangler JK	76410



Integrated, adjustable tire carrier fits up to 37" spare tire



Heavy duty steel tube internal framework



Cast steel hinge points and durable steel construction reduces sag



Steps allow easy access to top of your Jeep®



### OVERSIZE TIRE CARRIER

- Economical way to mount oversized tire to factory JK tailgate
- Uses tailgate's existing holes – no drilling required
- Completely adjustable - can mount up to 35" tire or 195 lbs.
- Carrier and tailgate open and close as a single unit
- Adjustable arm eliminates tailgate sag

Not compatible with OE wheels

#### OVERSIZE TIRE CARRIER

YEAR	MODEL	PART#
07-18	JK 2/4-DR	2743



### TIRE RELOCATION BRACKET

Tire Relocation Bracket available if needed to move tire 2" up and 1" out

#### TIRE RELOCATION BRACKET

YEAR	MODEL	PART#
07-18	CJ, YJ, TJ, JK, XJ	3721



## SLANT TIRE CARRIER ADAPTER KIT

Spare tire carriers in their conventional, upright positions are a necessity for every Jeeper, whether on the road or off, but when the terrain gets extreme and your standard hard top comes off, Smittybilt's new Slant Back Tire Carrier Kit allows you to move your spare tire into an aggressive, 45° pre-runner position.

- Designed for use with Smittybilt's XRC Gen2 Bolt-On Tire Carrier (#76857), Cargo Restraint System (C.RES) or JK Bowless Tops
- Manufactured from 3/16" cold rolled steel, weighs 8 lbs.
- 1" diameter hardened pin
- Easy, bolt-on installation. All hardware included
- Compatible with Rotopax® gas/water can and off-road jack mounts, if used with XRC Gen2 Bolt-on Tire Carrier (#76857)

*PLEASE NOTE: Combination of Pivot Tire Carrier (#2843) and Slant Adapter (#76857-05) is not compatible with Smittybilt Slant Hard Top (#518702/517702)*



**45° ANGLE**



XRC SLANT TIRE CARRIER		
YEAR	MODEL	PART#
07-18	Wrangler JK 2/4-DR	76857-05



Shown with XRC Gen2 Tire Carrier (#76857) and Slant Hard Top (#517702/518702)

## SRC PIVOT HD OVERSIZE TIRE CARRIER

If you are running oversized tires on your 07+ Jeep® Wrangler JK you need a full-size spare tire, but perhaps you don't want to run an aftermarket rear bumper with an integrated tire carrier. Smittybilt has the solution with their Pivot Heavy Duty Oversize Tire Carrier.

- Maintains easy single action of opening and closing of the tailgate
- Strong monoblock aluminum construction eliminates tailgate sag
- Adjustable tire mount with 37" maximum tire size, up to 135 lbs
- Forged chrome mounting brackets – 30% stronger than steel
- Protective EPDM gaskets included to protect factory finish
- 1" diameter hardened pin and hardened hinge points
- Third brake light mount included
- No drilling required - you can maintain OE bumpers, if preferred
- Mounting points for brackets to mount trail jack. Mount (#2844) and Trail Jack (#2722) sold separately

*PLEASE NOTE: Combination of Pivot Tire Carrier (#2843) and Slant Adapter (#76857-05) is not compatible with Smittybilt Slant Hard Top (#518702/517702)*



PIVOT HD OVERSIZE TIRE CARRIER		
YEAR	MODEL	PART#
07-18	Wrangler JK 2/4-DR	2843
07-18	Trail Jack Mount	2844







GET THE ORIGINAL

# NERF STEPS / SURE STEPS



Nerf Step



Sure Step



## A NERF STEPS

- Welded, one-piece units with .084" tube thickness
- 3" main tube with innovative four-step drop-down design
- Cleated step plates welded on and smoothed out for finished look
- Black version is lightly textured, gloss black not available for JKs
- No drilling required on most applications

## B SURE STEP

- Third center bracket and "No bounce" fit with secured compressed step area
- No exposed metal, generic length tubing or flimsy pad attachments
- No drilling of brackets making this the easiest-to-install tube step on the market

NERF STEPS				
YEAR	MODEL	GLOSS BLACK	STAINLESS STEEL	TEXTURED BLACK
12-18	Wrangler JK - 2-Door*	-	J1246-SS	J1246
07-11	Wrangler JK - 2-Door*	-	J0746-SS	J0746
07-18	Wrangler JK 4-Door*	-	J0764-SS	J0764

SURE STEPS				
YEAR	MODEL	GLOSS BLACK	STAINLESS STEEL	TEXTURED BLACK
84-01	Cherokee XJ - 4-Door	JN420-S4B	JN420-S4S	-
76-86	CJ7	JN40-S2B	JN40-S2S	JN40-S2T
07-18	Wrangler JK - 2-Door	JN48-S2B	JN48-S2S	JN48-S2T
07-18	Wrangler JK - 4-Door	JN49-S4B	JN49-S4S	JN49-S4T
97-06	Wrangler TJ	JN460-S2B	JN460-S2S	JN460-S2T
87-95	Wrangler YJ	JN44-S2B	JN44-S2S	JN44-S2T
04-06	Wrangler Unltd LJ	JN47-S2B	JN47-S2S	JN47-S2T

DESCRIPTION	PART#
Replacement Step Pad	PST-01

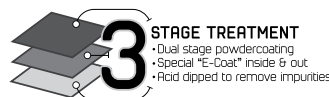





# SIDES, HOODS & ARMOR

PICTURED: XRC ARMOR SKINS AND XRC FLUX FLARES





GET THE ORIGINAL

# XRC SIDES TJ LJ YJ CJ7 XJ



## XRC ROCK SLIDERS

The XRC rock sliders are designed for the most extreme wheeling. All XRC sliders are manufactured out of 3/16" solid plate and are engineered to conform to the vehicle and protect your ride from the elements.

- 3/16" cold rolled steel and stainless steel hardware
- Wheel-to-wheel coverage for maximum protection
- Can be used with rear corner guards and factory flares
- Signature Series matte black textured powdercoat
- 5-Year Limited Warranty/Smittybilt Advantage Warranty

### A XRC ROCK SLIDERS TJ, YJ

XRC - ROCK SLIDERS (NO STEP)			
YEAR	MODEL	PART#	INSTALL
97-06	Wrangler TJ	76870	Drill
87-95	Wrangler YJ	76860	Drill

### B-C XRC ROCK SLIDERS W/STEP TJ, LJ, YJ, CJ

XRC - ROCK SLIDERS WITH STEP			
YEAR	MODEL	PART#	INSTALL
97-06	Wrangler TJ	76871	Drill
04-06	Wrangler LJ	76868	Drill
87-95	Wrangler YJ	76861	Drill
76-86	CJ7	76865	Drill

### D XRC ROCK SLIDERS XJ

XRC - ROCK SLIDERS			
YEAR	MODEL	PART#	INSTALL
84-01	Wrangler XJ 2/4-door	76853	Drill

### E XRC BODY CLADDING XJ

- 1/8" inch cold-rolled steel
- Protects the rocker panel area
- Compatible with stock and aftermarket flares
- 8 cladding pieces – kits include the rear cladding between the rear wheel well and bumper for full protection.

XRC - BODY CLADDING			
YEAR	MODEL	PART#	INSTALL
84-01	Wrangler XJ 2-door	76852	Drill
84-01	Wrangler XJ 4-door	76854	Drill





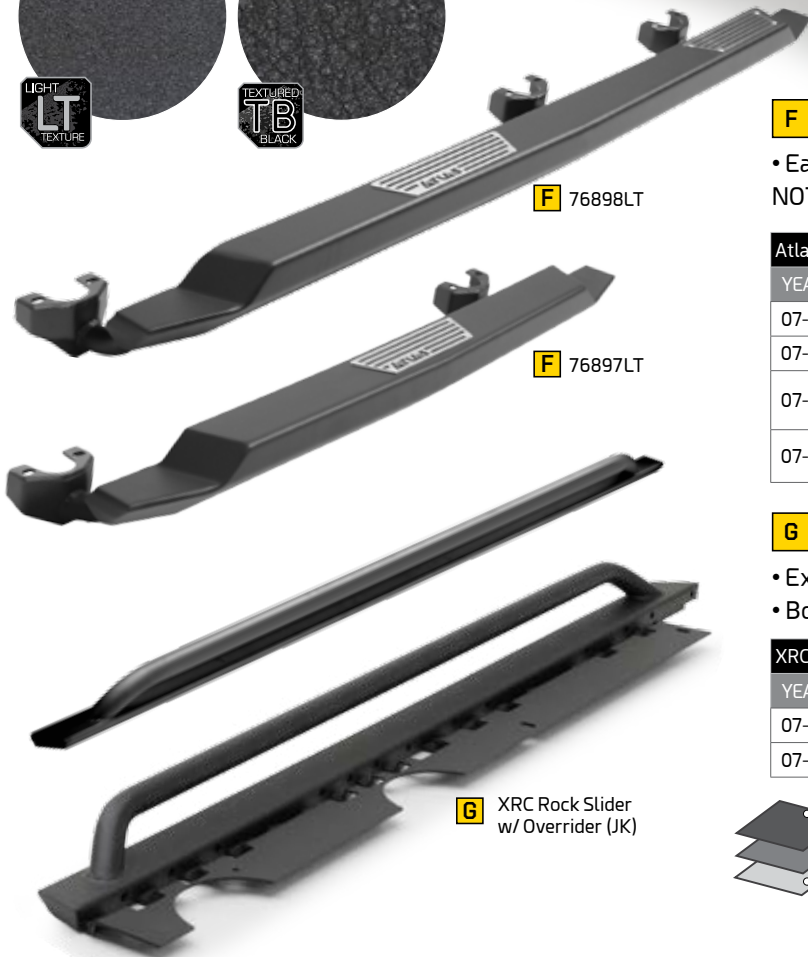
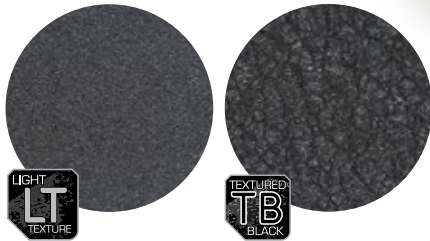

**F ATLAS ROCK SLIDERS w/STEP FOR JK**

- Each side features anti-slip step pads for easier access
- NOTE: Not compatible with XRC exterior armor.

Atlas ROCK SLIDERS w/ STEP, Bolt On				
YEAR	MODEL	DESCRIPTION	PART#	INSTALL
07-18	JK 2-Dr	Atlas Rock Sliders w/ Step	76897	No Drill
07-18	JK 4-Dr	Atlas Rock Sliders w/ Step	76898	No Drill
07-18	JK 2-Dr	Atlas Rock Sliders w/ Step - Light Texture	76897LT	No Drill
07-18	JK 4-Dr	Atlas Rock Sliders w/ Step - Light Texture	76898LT	No Drill

**G XRC ROCK SLIDERS w/OVERRIDER FOR JK**

- Extra protection with 2.0" overrider
- Bolts to factory holes - No drilling or modification

XRC - ROCK SLIDERS				
YEAR	MODEL	DESCRIPTION	PART#	INSTALL
07-18	JK 2-Dr	XRC - Rock Sliders	76890	No Drill
07-18	JK 4-Dr	XRC - Rock Sliders	76895	No Drill

**3 STAGE TREATMENT**

- Dual stage powdercoating
- Special "E-Coat" inside & out
- Acid dipped to remove impurities

**LIFETIME STRUCTURAL 5-YEAR FINISH WARRANTY**

**TEXTURED TB BLACK** **LIGHT TEXTURE**





# SRC SIDES JK TJ



## SRC ROCK SLIDERS

These heavy duty, steel tube side bars are built to take on the toughest terrain.

- One piece design with 2" .120" steel wall tubing
- Wheel-to-wheel coverage for maximum protection
- Signature Series matte black textured powdercoat
- 5-Year Limited Warranty/ Smittybilt Advantage Warranty

### A SRC SIDE ARMOR w/STEP

- Dual girder system provides the ultimate protection for the sides and under section of your Wrangler

SRC - SIDE ARMOR		
YEAR	MODEL	PART#
07-18	Wrangler JK 2-DR	76633
07-18	Wrangler JK 4-DR	76634
07-18	Wrangler JK 2-DR Light Texture	76633LT
07-18	Wrangler JK 4-DR Light Texture	76634LT
87-06	Wrangler YJ, TJ	76631*
04-06	Wrangler LJ Unlimited	76632

\*LT: Light Textured, not shown.

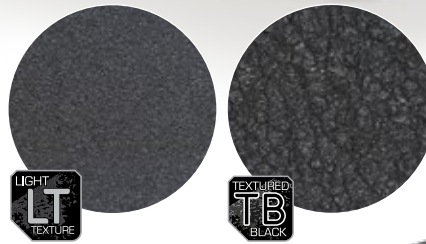

### B SRC ROCKER GUARD w/PLATE JK

- Features an upper tube for side protection
- 3/16" protective plating for extra protection

SRC - ROCKER GUARD w/ PLATE		
YEAR	MODEL	PART#
07-18	Wrangler JK 2-DR	76645
07-18	Wrangler JK 4-DR	76646
07-18	Wrangler JK 2-DR	76645LT
07-18	Wrangler JK 4-DR	76646LT

### C SRC ROCKER GUARD TJ, YJ, LJ

- Features an upper tube for side protection
- 3/16" protective plating for extra protection

SRC - ROCKER GUARDS		
YEAR	MODEL	PART#
87-06	Wrangler YJ, TJ	76641*
04-06	Wrangler LJ Unlimited	76642

\*LT: Light Textured, not shown.

NOTE: \*May not work with some shackle reversion suspensions



A SRC Side Armor w/Step for JK



B SRC Rocker Guard w/Plate for JK



C SRC Side Armor w/Step for TJ, LJ, YJ



D SRC Rocker Guard for TJ, LY, YJ

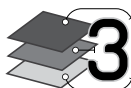

**3 STAGE TREATMENT**

- Dual stage powdercoating
- Special "E-Coat" inside & out
- Acid dipped to remove impurities

**LIFETIME**  
5 YEAR WARRANTY







### CLASSIC SIDE PROTECTION FOR JK

The SRC Classic line provides style and strong characteristics to the front of your Jeep®.

- Each side is designed for maximum protection
- Bolts directly up to factory holes—Body mount installation,
- Welded end caps
- Complements the front and rear bumpers
- Solid 1-Piece Design
- Sold in pairs
- Smittybilt Advantage Warranty

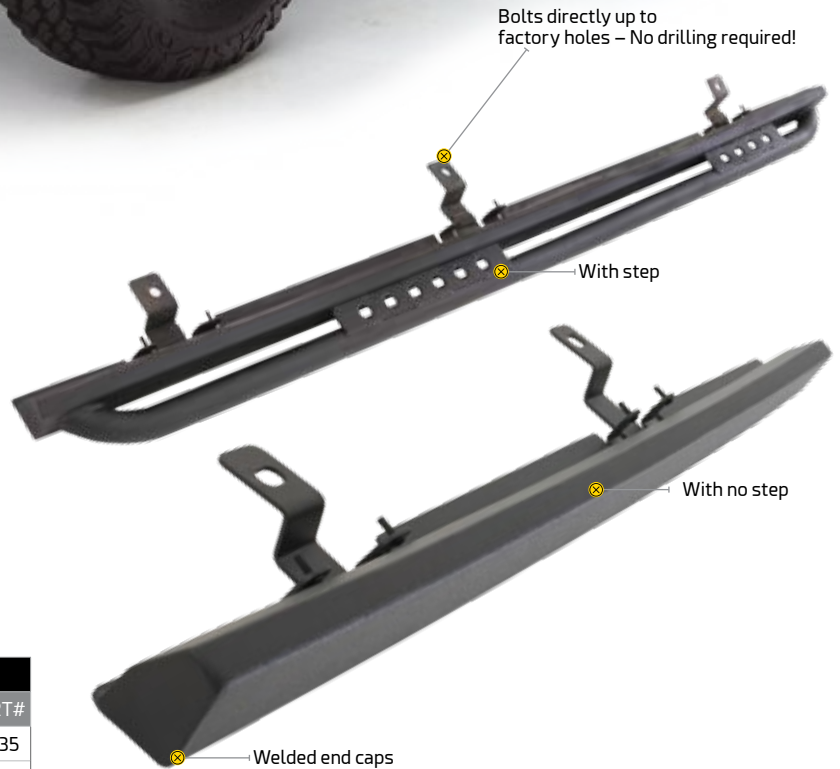

#### SRC - CLASSIC PROTECTION (Side)

YEAR	MODEL	DESCRIPTION	PART#
07-18	JK 2-DR	SRC Classic Side Protection	76635
07-18	JK 4-DR	SRC Classic Side Protection	76636
07-18	JK 2-DR	SRC Classic Side Protection w/Step	76638
07-18	JK 4-DR	SRC Classic Side Protection w/Step	76639

**3**

**STAGE TREATMENT**

- Dual stage powdercoating
- Special "E-Coat" inside & out
- Acid dipped to remove impurities

**LIFETIME**  
STRUCTURAL  
**5-YEAR** FINISH  
WARRANTY

**TEXTURED**  
**TB**  
BLACK





GET THE ORIGINAL

# HOODS JK



## STINGRAY VENTED HOOD

Smittybilt's state-of-the-art SRC Stingray Vented Hood will not only will give your JK a more aggressive look, it functions to keep your engine cooler than that of its OE counterpart. Manufactured from 0.8mm steel, combined with a thick underbody insulation mat and ability to accept factory hardware, this hood is precision made and here for the long run.

The hood is supplied with a premier black finish e-coat, so it's ready for paint without any further preparations. Even though it's built tough, Smittybilt has ensured your safety by retaining the factory crumple zones, and has it covered with their Advantage Warranty.

- A** Vents hot gasses out of engine bay - keeps your engine cooler than its OE counterpart
- B** Precision construction from 0.8mm steel
- C** Thick underbody insulation mat
- D** Accepts factory hardware. Hood nozzles included
- E** 0.2mm black finish e-coat that's ready for paint
- F** Retains the factory crumple zones
- G** OE hood latch/hood mount fitment

SRC Stingray Vented Hood			
YEAR	MODEL	DESCRIPTION	PART#
07-18	JK Wrangler 2/4-DR	SRC Stingray Vented Hood	76400



Vent hot gasses out of engine bay



OE hood latch/hood mount fitment



Factory crumple zones retained



8.7mm thick underbody insulation mat





**H.E.M.I. VENTED HOOD  
(HEAT EXTRACTING MODIFIED INLET)**

Smittybilt's newest edition to its Heat Management Series of vented hoods provides 4" additional inches of engine clearance for many types of engine swaps. The hood is supplied with a premier black finish e-coat, so it's ready for paint without any further preparations. Even though it's built tough, Smittybilt has ensured your safety by retaining the factory crumple zones, and has it covered with their Advantage Warranty.

- A** Extra engine clearance for V8 swaps with up to 4" of clearance
- B** Significantly improves cooling and heat dissipation
- C** Side vents pop out for personal customization
- D** Gives your JK an aggressive look
- E** Thick underbody insulation mat
- F** Accepts factory hardware. Hood nozzles included
- G** 0.2mm black finish e-coat that's ready for paint
- H** OE hood latch/hood mount fitment

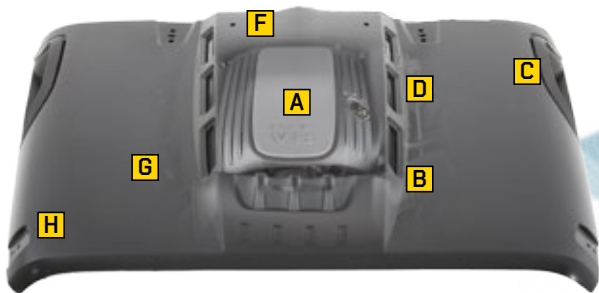

H.E.M.I. Vented Hood			
YEAR	MODEL	DESCRIPTION	PART#
07-18	JK Wrangler 2/4-DR	H.E.M.I. Vented Hood	76500



Improves cooling and head dissipation



OE hood latch/hood mount fitment



Side vents pop out for customization

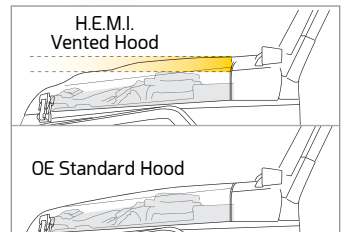

Up to 4" of additional clearance over OE





GET THE ORIGINAL

# DOORS JK TJ



## SRC GEN2 TUBE DOORS FOR JK

The new tube doors from Smittybilt are easy to install and are available for 2007-18 Jeep® JK Wranglers. Each door's unique design complements the looks of your JK without sacrificing strength and integrity.

- Robust 1.5" 0.090 wall tubular design
- Uses factory striker with our latch
- New upgraded hinges/billet alloy handle and integrated mirror mount
- Added visibility both on and off-road, opens from in or outside the vehicle
- Bolt-on mirror relocation brackets and door straps included
- MOLLE door panels included



MOLLE panels (included) can be mounted inside or outside

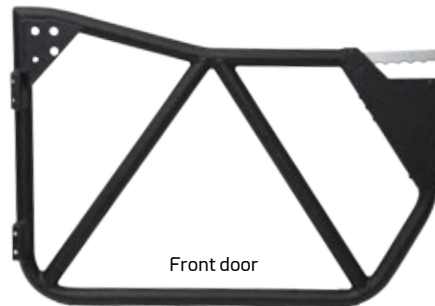

Front door



Rear door



Easy-grip billet handle



Door straps included



Durable door bumper



Mirror relocation bracket



Mounts to factory hinges

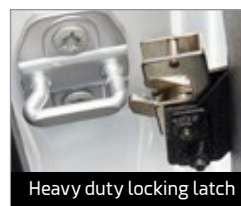

Heavy duty locking latch



## SRC GEN1 TUBE DOORS FOR TJ

Smittybilt's popular SRC Tube Doors for Jeep® TJs are still available.

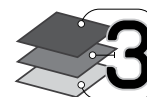

**3 STAGE TREATMENT**  
 • Dual stage powdercoating  
 • Special "E-Coat" inside & out  
 • Acid dipped to remove impurities

**LIFETIME**  
**STEEL**  
**5 YEAR**  
**WARRANTY**

**TEXTURED**  
**TB**  
**BLACK**

SRC TUBE DOORS			
YEAR	MODEL	DESCRIPTION	PART#
07-18	JK 2/4 Door	SRC Gen2 Tube Doors - Front	76794
07-18	JK 4 Door	SRC Gen2 Tube Doors - Rear	76795
97-06	TJ	SRC Gen1 Tube Doors	76793



# ARMOR JK



## XRC FLUX FLARES FOR JK

- Sturdy flares made of CNC bent 1.5" diameter tube covered with 1/8" laser cut cold rolled sheet metal
- Allows increased articulation: provides extra outer tire clearance for larger tires under full suspension articulation
- 6" wide and providing extra 3" of suspension travel
- Double articulated tube fenders
- Preserves the factory inner liner
- 3/4" L.E.D. turn signal lights included
- Keeps your center of gravity lower
- Spacers and brackets provided to tie fenders to sub frame for extra strength
- Minimal modification for installation, bolts to same OE mounting points

Dual angled for better articulation



**3** STAGE TREATMENT

- Dual stage powdercoating
- Special "E-Coat" inside & out
- Acid dipped to remove impurities

**LIFETIME** ESTABLISHED DURABLE  
**5 YEAR** FINISH WARRANTY

**TEXTURED TB** BLACK

XRC FLUX FLARES / REPLACEMENT LED			
YEAR	MODEL	DESCRIPTION	PART#
07-18	JK 2/4 DR	XRC Flux Flares - Front (pair)	76838
07-18	JK 2/4 DR	XRC Flux Flares - Rear (pair)	76839
Replacement Lights - 3/4" LED Turn Signal (pair)			L-1420



## REPLACEMENT LIGHT FOR FLUX FLARES

DESCRIPTION	PART#
3/4" L.E.D. Turn Signal	L-1420

- 12" lead wires and grommet style mounts
- Super bright L.E.D. lights
- Waterproof casing

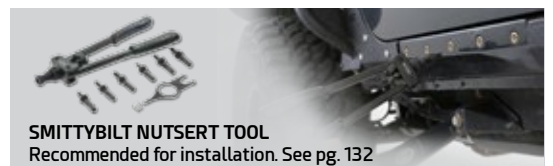

**SMITTYBILT NUTSERT TOOL**  
Recommended for installation. See pg. 132





GET THE ORIGINAL

# ARMOR JK



## XRC JK BODY ARMOR SKINS

Smittybilt has everything you need to protect your Jeep® JK Wrangler and Wrangler Unlimited from bumper to bumper. Smittybilt's XRC front tube fenders, rear tube fenders and rear quarter panels are made from 1/8-inch cold rolled steel that is perfectly contoured to the factory body lines and includes the necessary mounting hardware. All XRC armor is powdercoated in a two-stage textured matte black finish and feature Smittybilt's limited lifetime warranty.

### Front Skins

- Made of 1/8" cold rolled steel to provide maximum protection
- Have the ability to bolt the stock fenders back on
- Two-stage textured matte black powdercoat finish
- Drilling required, all hardware included

### Rear Skins/Quarter Panel

- Made of 1/8" cold rolled steel to provide maximum protection
- Maximum rear quarter panel protection from door jam to tailgate jam
- Contours perfectly to the OE panels
- Integrated protection for rear tail lights
- Have the ability to bolt the stock fenders back on
- Two-stage textured matte black powdercoat finish
- Drilling required, all hardware included

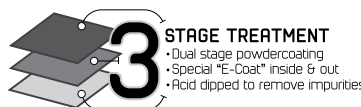

Rear skins on JK 4-Door



Rear skins on JK 2-Door

XRC BODY ARMOR SKINS			
YEAR	MODEL	DESCRIPTION	PART#
07-18	JK Wrangler 2/4-DR	XRC Body Armor - Front Skins (pair)	76980
07-18	JK Wrangler 2-DR	XRC Body Armor - Rear Skins (pair)	76981
07-18	JK Wrangler 4-DR	XRC Body Armor - Rear Skins (pair)	76982

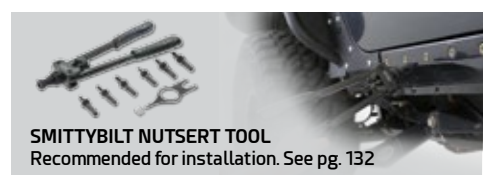





- A** XRC Rear Corner Guard w/Fender
- B** XRC Body Cladding
- C** XRC Front Fenders
- D** M-1 Mesh Grille

**3** STAGE TREATMENT

- Dual stage powdercoating
- Special "E-Coat" inside & out
- Acid dipped to remove impurities

**LIFETIME**  
STRUCTURAL  
**5-YEAR** FINISH  
WARRANTY

**TEXTURED**  
**TB**  
BLACK

### XRC FENDERS/ CORNER GUARDS FOR JK

- Maximum wheel well clearance with complete inner liners to keep mud, dirt and snow away from engine compartment
- Cutting edge design for complete system: front, rear and sides
- Rustproof stainless steel fasteners
- Replaceable slide plates
- Removable side ducts to accommodate a snorkel

XRC FENDERS / CORNER GUARDS			
YEAR	MODEL	DESCRIPTION	PART#
07-18	Wrangler JK 2/4-Dr	Front Fenders	76880
07-18	Wrangler JK 2-Dr	Rear Corner Guards w/Fenders	76881
07-18	Wrangler JK 4-Dr	Rear Corner Guards w/Fenders	76882

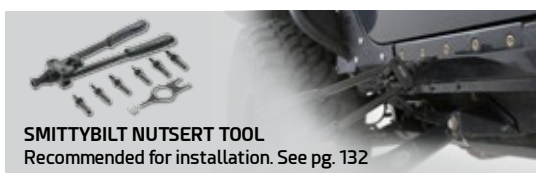

### XRC BODY CLADDING FOR JK

- Follows body contour to exacting specifications
- Complete lower quarter protection when used with XRC Rock Sliders
- Works with OE and aftermarket flares as well as XRC Body Armor Skins and XRC Flux Flares
- 304 marine grade stainless steel button head hardware

XRC BODY CLADDING			
YEAR	MODEL	DESCRIPTION	PART#
07-18	Wrangler JK 2-Dr	Body Cladding	76886
07-18	Wrangler JK 4-Dr	Body Cladding	76887

### M-1 GRILLES

- Complements the looks of today's vehicles
- No exposed welds – robotically welded
- Manufactured out of marine grade 304 stainless steel with stainless steel plated lugs
- Textured black powdercoat, 5-year finish warranty
- Modifications to the OE grille shell required
- Special heavy duty packaging to ensure grille will arrive undamaged



M-1 MESH GRILLES			
YEAR	MODEL	DESCRIPTION	PART#
07-18	JK Wrangler 2/4 Dr	M-1 Mesh Grille	615850



## XRC 4" STEEL FENDER FLARE KIT FOR JK

- Streamlined design for increased suspension articulation while maintaining street look
- 100% steel construction for extra durability
- Powdercoated for immediate use or paintable to match vehicle color
- Includes front and rear fenders

**A 4" STEEL FENDER FLARE KIT**

YEAR	MODEL	PART#
07-18	Wrangler JK 2/4-Dr	76837



**3 STAGE TREATMENT**

- Dual stage powdercoating
- Special "E-Coat" inside & out
- Acid dipped to remove impurities

**LIFETIME STRUCTURAL 5-YEAR FINISH WARRANTY**

**TEXTURED TB BLACK**



### XRC FRONT FENDERS

- Tubular design to provide strength and durability
- Available with a 3" flare incorporated into the fender
- Modifications to the front O.E. fender is required
- Relocates factory latch to provide a finished look
- Stainless Steel hardware

### XRC ROCK SLIDERS

- Available with or without a step
- Can be used with rear corner guards
- Fits with or without factory flares
- Stainless Steel hardware

### XRC BOLT-ON FLARES

- Available with or without a 3" flare
- Can be used with Rock Sliders®
- Factory Tail Lamps can be used
- Stainless Steel hardware



**B XRC FENDERS W/ BUILT IN FLARE**

YEAR	MODEL	PART#
97-06	Wrangler TJ	76873
87-95	Wrangler CJ	76863
76-86	Wrangler YJ	76867



**D XRC ROCK SLIDERS W/ STEP**

YEAR	MODEL	PART#
97-06	Wrangler TJ	76871
04-06	Wrangler CJ	76868
87-95	Wrangler YJ	76861
76-86	CJ7	76865



**F XRC REAR BOLT-ON FLARE**

YEAR	MODEL	PART#
97-06	Wrangler TJ	76875
87-95	Wrangler YJ	76877
76-86	CJ7	76879

**C XRC FENDERS**

YEAR	MODEL	PART#
97-06	Wrangler TJ	76872
87-95	Wrangler CJ	76862
76-86	CJ7 YJ	76866

**E XRC ROCK SLIDERS (Not pictured)**

YEAR	MODEL	PART#
97-06	Wrangler TJ	76870
87-95	Wrangler CJ	76860

**G XRC REAR CORNER GUARDS**

YEAR	MODEL	PART#
97-06	Wrangler TJ	76874
87-95	Wrangler YJ	76876
76-86	CJ7	76878



### 6" FENDER FLARES FOR TJ, YJ

- 6" extra-wide fender flares
- Textured UV-stable ABS
- Paintable
- Minimal drilling for installation

**6" EXTRA-WIDE FENDER FLARES**

YEAR	MODEL	PART#
97-06	Wrangler TJ	17190
87-95	Wrangler YJ	17191





**MAG  
ARMOR**  
MAGNETIC SIDE PROTECTION

**9**  
MAGNETIC  
PIECES



07-18 Wrangler JK, 2DR

**15**  
MAGNETIC  
PIECES

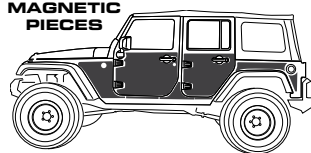

07-18 Wrangler JK, 4DR

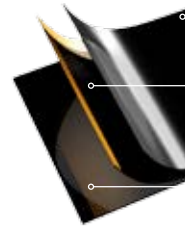

**OUTER LAYER:**  
Durable, rust resistant, German-manufactured PVC

**MIDDLE LAYER:**  
Powerful rare earth Stratum Ferrite magnet for unparalleled holding strength

**INNER LAYER:**  
UV-hardened coating protects paint of the vehicle average thickness is 10 microns.

## MAG-ARMOR

- Protects sides and doors from trail hazards
- Magnetic and pliable backing for easy install
- Triple-layered protection 0.062" (1.6mm) thick
- Custom CNC-cut to fit your JK perfectly
- Highway rated up to 80MPH
- Working temperature of 0–130°F
- Matte black finish
- Printable surface for ultimate customization
- Reusable tube for convenient and safe storage
- Micro cleaning cloth included



**MAGNETIC:**  
Ferrite magnet for unparalleled holding strength



**LIGHTWEIGHT:**  
Durable, lightweight, easy storage & rust resistant PVC



**SCRATCH RESISTANT:**  
UV-hardened coating protects paint

MAG-ARMOR		
YEAR	MODEL	PART#
07-18	Wrangler JK, 2 Door	76992†
07-18	Wrangler JK, 4 Door	76994†

† Trail Rated badge may need to be relocated

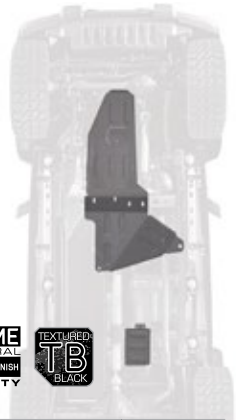

## XRC SKID PLATES FOR JK

When wheeling off-road you can never have too much protection. The new Smittybilt skid plates are designed to provide the ultimate protection for essential components.

- Ultimate protection for essential components
- Thick, 3/16" steel shields your JK from hard hits on the trail
- Precision laser cut for a perfect fit
- Easy, no-drill, 100% bolt-on installation
- All hardware included

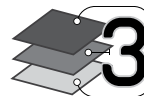

**3 STAGE TREATMENT**  
• Dual stage powdercoating  
• Special "E-Coat" inside & out  
• Acid dipped to remove impurities

**LIFETIME STRUCTURAL 5-YEAR FINISH WARRANTY**

**TEXTURED TB BLACK**

XRC SKID PLATES				
	YEAR	MODEL	DESCRIPTION	PART#
A	07-18	JK 2/4-DR	XRC Transfer Case	76920
B	07-18	JK 2/4-DR	XRC Evaporator Canister Guard	76921
C	07-18	JK 2/4-DR	XRC Engine/Transmission Skid Plate	76922*
A-C	07-18	JK 2/4-DR	XRC Skid Plate Kit	76923

\*2" Lift required



GET THE ORIGINAL

# SMITTYBILT DEFENDER RACKS



Shown with  
45454

Works with JK  
Mount DS31-4

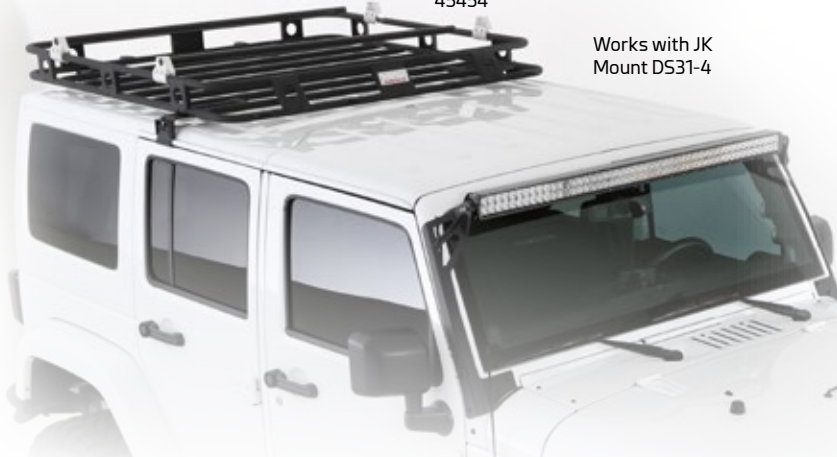

*"It was so easy installing your SRC Roof Rack Base with the 4.5x5 Defender Roof Rack on my 1998 Wrangler. It not only looks great but it holds a lot of my stuff!"*

– T. Wong, Cypress, TX

## SMITTYBILT DEFENDER RACK

Made with heavy duty 16-gauge steel, the Smittybilt Defender Rack series maximizes your cargo carrying capabilities with aerodynamic styling that complements today's vehicles. Racks feature fully welded joints and light tabs; one-inch of attachments, integrated flooring to maximize functionality; and multiple mounting options for a variety of applications. Choose from three versions: the one-piece offers additional structural stability with fewer moving pieces, while the two-piece bolt-together version is shippable via UPS for added convenience. Optional mounts for axes, shovels, trail jacks and spare tires can also be bolted directly on to your Smittybilt Defender Rack.

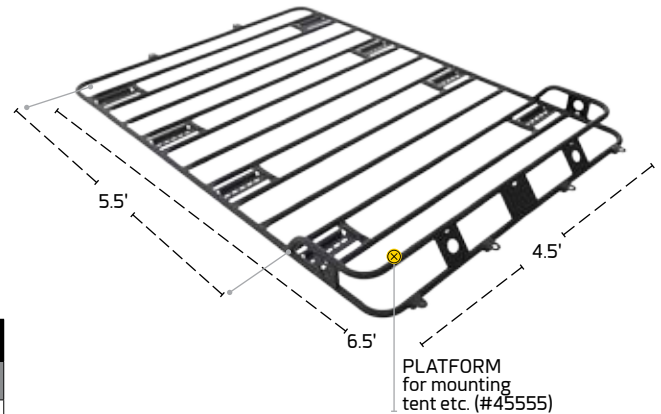
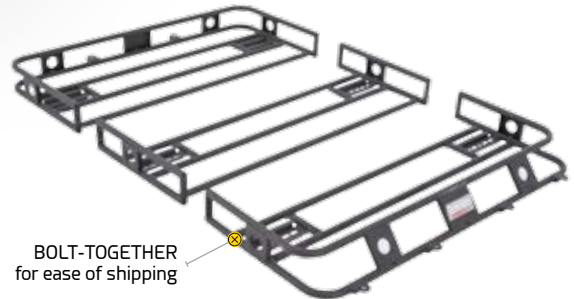
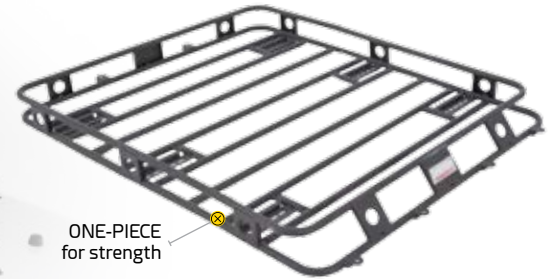

### DEFENDER RACKS FOR JEEPS

YEAR	MODEL	SIZE	1 PIECE	BOLT-TOGETHER	MOUNT
03-06	Liberty w/fac roof rack	4'x4'	40404	40405	DS-20
2008	Liberty Sport/Ltd w/fac roof rack	4'x4'	40404	40405	DS16-4
2008	Apen limited	4'x4'	40404	40405	DS2-4
04-06	Jeep TJ Unltd with hard top	4.5'x6.5'	45654	45655	AM-8
76-06	CJ-YJ-TJ w/hard top	4'x5'	40504	40505	AM-6
76-86	Scrambler w/ hard top	4'x5'	40504	40505	AM-6
06-10	Grand Cherokee w/fac roof rack	4'x4'	40404	40405	DS16-4
2005	Grand Cherokee w/fac roof rack	4'x4'	40404	40405	DS25-4
02-04	Grand Cherokee w/fac roof rack	3.5'x5'	35504	35505	DS2-6
93-01	Grand Cherokee w/fac roof rack	3.5'x5'	35504	35505	DS5-6
90-01	Cherokee/Wagoneer XJ w/fac rack	4'x5'	40504	40505	DS5-6
84-89	Cherokee/Wagoneer XJ w/fac rack	4'x5'	40504	40505	DS2-6
84-01	Cherokee/Wagoneer XJ w/out rack	4.5'x5'	45504	45505	HDS-6
06-09	Commander w/ fac roof rack	4.5'x5'	45504	45505	DS24-6
07-18	Jeep JK 4 Door Hardtop Only	4.5'x4.5'	45454	—	DS31-4
All	Flat Rack (platform only)	4.5'x5.5"	45555	—	Any



### JK BASKET

- 32" wide x 18" deep x 4" tall
- Holds up to 35 lbs of gear
- Accepts Smittybilt Defender Rack accessories
- Bolts to Wrangler 07-18 tailgates
- No drilling required – 100% bolt-on installation

JK BASKET		
YEAR	MODEL	PART#
07-18	Wrangler JK 4/2-DR	76718

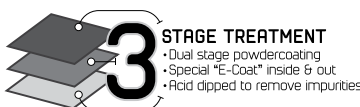





## A ROOF RACK LIGHT CAGE

- Made from same heavy duty steel as Smittybilt Defender Racks
- Provides protection for four of your lights that have a diameter of up to nine inches (lights not included)

ROOF RACK LIGHT CAGE	
DESCRIPTION	PART #
Fits 4' wide Smittybilt Defender Rack	40002
Fits 4.5' wide Smittybilt Defender Rack	45002
Fits 5' wide Smittybilt Defender Rack	50002

## B CARGO NET

- Keep your gear safe and in place
- Nets will attach to almost any roof rack, truck bed and most trailers
- Stretchy style cord so it will always conform to your load
- Available in two sizes

CARGO NET	
DESCRIPTION	PART #
Large - 48" x 48" un-stretched 80" x 80" stretched	DN11101
Small - 48" x 94" un-stretched 80" x 157" stretched	DN11201

## C ACCESSORY MOUNTS

- Heavy duty steel mounting brackets provide secure fastening of axe, shovel or trail jack to your Smittybilt Defender Rack
- Mounts and hardware included
- Brackets can accept a standard padlock for security (padlock and trail jack not included)
- Mount only - accessories sold separately

ACCESSORY MOUNTS	
DESCRIPTION	PART #
Axe & Shovel Mount w/Adapter Brackets	D8138
Trail Jack Mount w/ Adapter Brackets	D8076
Axe & Shovel Brackets	D8005
Trail Jack Mounts	D7031
Gas Can Mount	D8007

## D SPARE TIRE MOUNT

- Attaches securely to Smittybilt Defender Rack
- Allows storage of spare tire up to 33" in diameter
- Adapter is adjustable for varying wheel widths

SPACE TIRE MOUNT	
BOLT PATTERN	PART #
5 x 4-1/2"	D8545
5 x 5-1/2"	D8555
6 x 5-1/2"	D8655
8 x 6-1/2"	D8865
8 on 170mm	D8875

## E LED LIGHT BAR MOUNTING KIT

- Dual level mounting system for Smittybilt Defender Racks allows you to mount LED light bars up to width of your rack
- Adjustable for all sizes of light bars
- Kit includes 1" crossbars, side brackets and four CNC-machined light bar tabs
- No drilling required. Lights not included
- Light Tabs sold separately D8082

LED LIGHT BAR MOUNTS	
DESCRIPTION	PART #
4' Defender Rack LED Light Bar Mount Kit	D8084
4.5' Defender Rack LED Light Bar Mount Kit	D8045
5' Defender Rack LED Light Bar Mount Kit	D8085
Light Bar Tabs only (pair) fits 1" tubes	D8082

## F BRACKETS FOR 50" LED LIGHT BARS

- No drilling required, all hardware included
- Works with 4.5' racks only

LIGHT BRACKETS	
DESCRIPTION	PART #
Brackets only for 4' rack (pair)	D8083

## G CROSSBAR BRACKET KIT

- CNC-machined steel
- Fits all Defender by Smittybilt racks - easy install
- Can be used to attach Yakima or Thule-type accessories
- Textured black finish
- Includes four brackets

CROSSBAR BRACKET KIT	
DESCRIPTION	PART #
Crossbar Bracket Kit	D8081

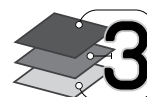

**3 STAGE TREATMENT**  
 • Dual stage powdercoating  
 • Special "E-Coat" inside & out  
 • Acid dipped to remove impurities

**LIFETIME STRUCTURAL 5-YEAR FINISH WARRANTY**

**TEXTURED TB BLACK**



GET THE ORIGINAL

# ROOF RACKS



## SRC ROOF RACK

Finally, a complete roof rack system that is tough enough for off-road! Constructed of powdercoated 2" x .120" steel tubing, backed by heavy-duty 3/16-1/4" brackets, this Roof Rack system is as tough as it is durable.

- Removable crossbars for easy top removal
- Designed for use with most aftermarket accessories (Thule, Yakima, etc.)
- The perfect add on rack for all SRC front, rear and side tubular products
- Four-point mounting system holds up to 700 lbs
- Contoured design eliminates "boxy" look
- Custom designed for your Jeep
- Add on the lightweight Smittybilt™ Rugged Rack for the ultimate off-road rack/basket combination (see below)
- Modular design is easy to install – Can be shipped UPS
- Smittybilt Advantage Warranty



**A** SRC Roof Rack JK 2-DR

**B** SRC Roof Rack JK 4-DR

**C** Rugged Rack

SRC ROOF RACK		
YEAR	MODEL	PART#
07-18	Wrangler JK 2-DR	76716
07-18	Wrangler JK 4-DR	76717
87-95	Wrangler YJ	76711
97-06	Wrangler TJ	76713
04-06	LJ Unlimited	76715



Removable Cross Bars

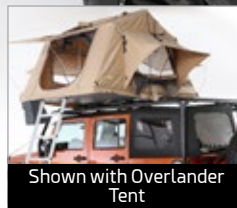

Shown with Overlander Tent

NOTE: No-drill installation with XRC bumpers or stock bumpers. Drilling required when using SRC bumpers. Installation requirements with other OE bumpers will vary.

## RUGGED RACK (BASKET)

- Aluminum rack for all SRC front, rear and side tubular products – attaches to SRC Roof Rack for ultimate off-road rack/basket combination
- 6.75" Height x 70" Length x 50" Width
- Easy to install and is shippable through UPS



UNIVERSAL RUGGED RACK		
YEAR	MODEL	PART#
All	Rugged Rack Basket (Universal)	17185
All	Smittybilt Defender Rack mount brackets	DRS-6

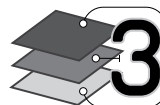

### 3 STAGE TREATMENT

- Dual stage powdercoating
- Special "E-Coat" inside & out
- Acid dipped to remove impurities







**iRACK**

iRack is one of the smartest products introduced to the trail. This system gives you a solid platform to mount just about anything you can think of to the back of your Jeep. The iRack comes with custom mounts for a Jerry can or jack. The multiple attachment points allow you the opportunity to run military bags, axes, picks and shovels. This is truly one of the smartest racks on the trail today.

- Attaches to any factory or aftermarket Jeep tire carrier
- Comes standard with Jerry Can attachments
- Manufactured out of 3/16" cold rolled steel
- Comes with all necessary hardware to mount trail or high lift jack
- Multiple attaching points

**iRACK2**

The all new Intelligent Rack 2 takes the functionality of the original iRack to a completely new level. You still get all the benefits of the original rack, except now it is a completely universal design allowing it to be mounted to any vehicle with a spare tire on the back! This is absolutely one of the smartest products introduced to the trail. Having this system provides you with a solid platform to mount just about anything you can think of to the back of your vehicle.

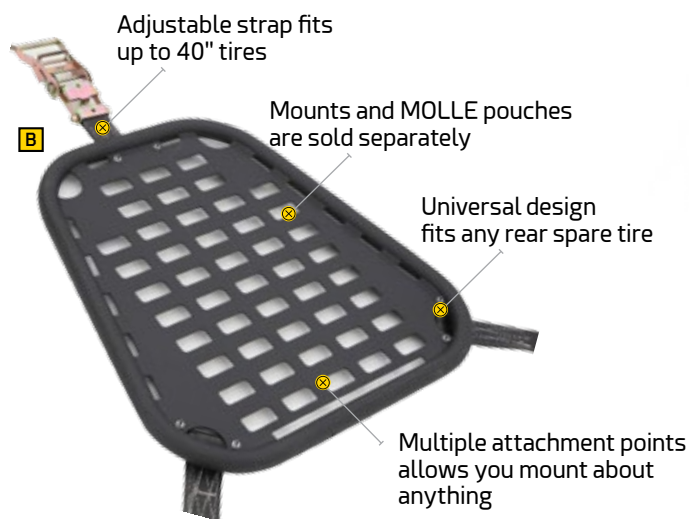

iRACK (INTELLIGENT RACK)	
DESCRIPTION	PART#
<b>A</b> iRack - Complete kit for Wranglers	2740
<b>B</b> iRack 2 - Universal application, base platform only	2739
<b>C</b> Blitz-style Gas Can Mount	2740-02
<b>D</b> Jack Mount	2740-03
<b>E</b> Universal Gas Can Mount	2740-04





GET THE ORIGINAL

# CAGE KITS JK



## EXOSKELETON FOR JK

Smittybilt's new Exoskeleton for two and four-door 07+ Jeep Wrangler JKs fends off rocks and obstacles. The 1.75-inch diameter, 0.120-wall tubing is thick enough to prevent damage, yet the entire exoskeleton only weighs 257 pounds, minimizing the effects on your Jeep's handling and performance. Integrated mounting tabs allow you to add LED light bars, jacks, or anything else you can think of. The modular design of Smittybilt's Exoskeleton allows for a huge boost in safety while allowing easy installation and removal of both hard and soft tops.

- Made of sturdy 1.75" .120 wall tube
- Mounts directly onto vehicle body
- Maintains existing bumper and armor fitment of all Smittybilt bumpers and armor
- 14 touch points to improve mounting integrity
- B-pillar fixing point to reduce 'swaying' effect
- Four crossbars for rack/tent mounting
- Windshield crossbar for roof access
- Crossbars are removable for soft top or hard top removal
- Rear-facing light mounting tabs
- Front light bar mounting brackets can accommodate two 50" LED light bars
- Powdercoat finish - 5-year limited warranty
- Smittybilt limited lifetime warranty
- Entire system comes in at a light 257 lbs

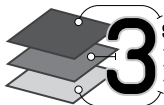

### 3 STAGE TREATMENT

- Dual stage powdercoating
- Special "E-Coat" inside & out
- Acid dipped to remove impurities

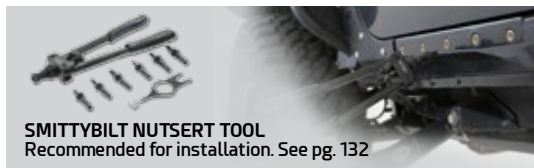

**SMITTYBILT NUTSERT TOOL**  
Recommended for installation. See pg. 132

EXOSKELETON		
YEAR	MODEL	PART#
07-18	Wrangler JK, 2 Door	76841
07-18	Wrangler JK, 4 Door	76840



**SRC CAGE KITS FOR JK, TJ**

Smittybilt's reinforced cage kits are everything you'll need to strengthen your factory roll bar into a solid foundation. We start off with 1020 .120 Wall DOM tubing which is one of the strongest materials available. Each kit includes the new Knuckle System that attaches to the factory roll bar, using a unique pivot and fastening point which creates the strongest and the most durable mounting system available for your Jeep. All cages are engineered to bolt on directly and require no modifications to the vehicle. This ensures a rock solid install while creating one of the strongest cage kits available.

- Manufactured from 1020 .120" Wall DOM and made with 1.75" strong tubing material
- Built-in tubular grab handles provide easy entry and exit points when getting in and out of your vehicle
- Knuckle attaches using a unique pivot on one end and Grade 10 fasteners on the other, making it one of the strongest mounts available
- CNC-machined to exact specifications to ensure a rock solid mount
- Satin black powdercoat finish with 5 year limited finish warranty
- Requires modification to factory roll bar covers
- Smittybilt Advantage 5-Year Warranty
- Padding kit included



SRC CAGE KIT			
YEAR	MODEL	PCS	PART#
07-10	Wrangler JK 2-DR	7 Piece	76901**
07-10	Wrangler JK 4-DR	6 Piece	76902
11-18	Wrangler JK 2-DR	7 Piece	76903**
11-18	Wrangler JK 4-DR	6 Piece	76904
97-06	Wrangler TJ, LJ	7 Piece	76900*

\* Rear bar needs to be removed with Bowless Top  
 \* Works with 03-06 Sound pods  
 \*\*Will not work w/ Bowless Top

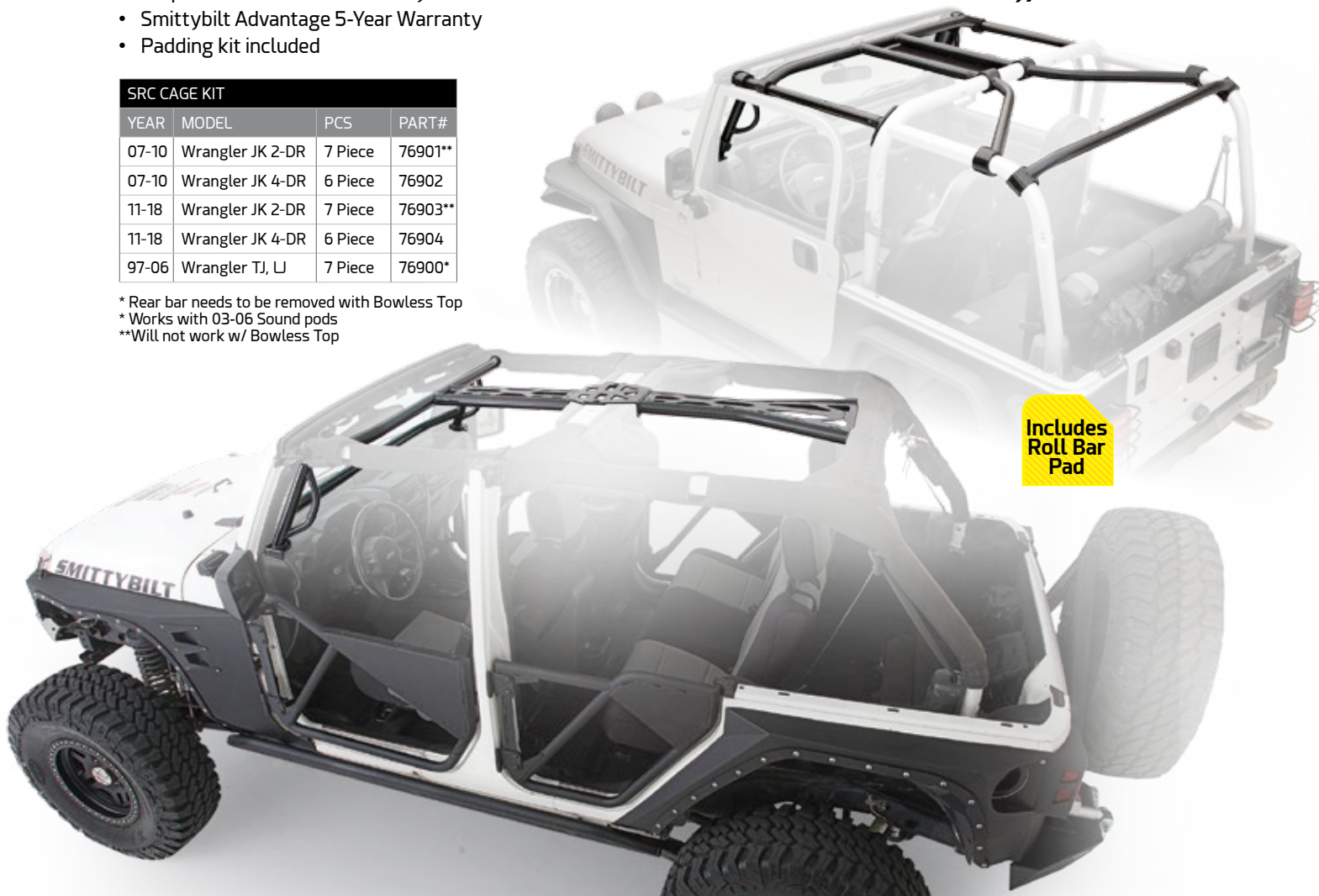

**3** STAGE TREATMENT  
 • Dual stage powdercoating  
 • Special "E-Coat" inside & out  
 • Acid dipped to remove impurities

**LIFETIME** STRUCTURAL **5 YEAR** FINISH WARRANTY

**TEXTURED TB** BLACK







**JEEP TOPS**  
PICTURED: BOWLESS COMBO TOP







### HARD TOPS JK/ TJ

Quiet, highest quality hard tops with DOT glass and easy installation.

Page 74



### BOWLESS COMBO TOP JK/ TJ

Ultimate versatility – open in the summer and closed up during foul weather.

Page 78

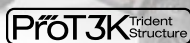

### PROT3K REPLACEMENT JK/ TJ

Soft top with exceptional cold weather performance and European styling.

Page 77



### REPLACEMENT TOPS JK/ TJ/ YJ/ SUZUKI

Complete replacement soft tops and EO-style soft top accessories.

Page 80



### BRIEFS JK/ TJ/ LJ/ YJ/ CJ

Choose from standard or extended briefs to protect passengers from the sun.

Page 82



### COVERS JK/ XJ/ TJ/ LJ/ YJ/ CJ

Tonneau, windbreakers, spare wheel and full cab cover.

Page 82



### MESH TOPS AND SIDES JK/ TJ

Reduces the glare and heat of the sun while letting cool air flow throughout.

Page 84



### CARGO RESTRAINT JK/ TJ/ YJ

Military-grade webbing contains your gear as you're charging the Hammers.

Page 85





GET THE ORIGINAL

# HARD TOPS

**1** PIECE DESIGN  
FOR WRANGLER JK



Wide opening for easy cargo access with dual hydraulic struts

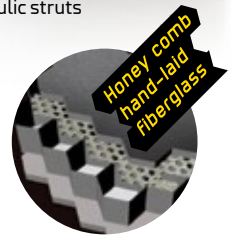

## SAFARI HARD TOP

Smittybilt's new Safari Hardtop puts the "fun" in functional with unique overland look.

- One-piece design
- Manufactured from honeycomb hand-laid fiberglass for extra strength and rigidity
- DOT-approved safety glass - 31% Tint
- 14.25 cubic ft. of extra interior space (4 Door)
- Dual rear window hydraulic lift struts
- Military spec mildew resistant carpeted headliner
- Textured black grain finish with thick, UV-stable gel coat
- Overhead portal windows increase ambient lighting and add interior space

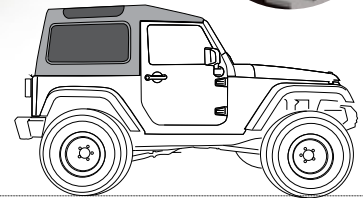

Weight: 2 Door: 275 lbs



Made in the USA

**LIFETIME**  
STRUCTURAL  
**5-YEAR**  
FINISH  
WARRANTY

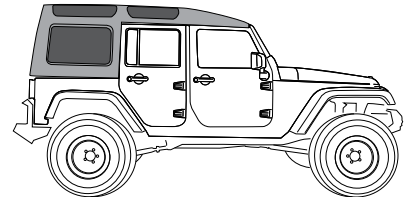

Weight: 4 Door: 320 lbs

### 5.5" ADDITIONAL HEADROOM

Exclusive raised roof design provides additional headroom



### Optional:

Smittybilt Defender Roof Rack

- 4 door: Rack# 40504, Mount # AM-6
- 2 door: Rack# 40404, Mount # AM-4

### SAFARI HARD TOP

YEAR	MODEL	PART#
07-18	Wrangler JK 2-DR	517702
07-18	Wrangler JK 4-DR	518702



Overhead portal windows



Increased interior space



Optional Smittybilt Defender Roof Rack available.



JK 2 Door Safari Hardtop



Hydraulic Lift Struts



**2** PIECE DESIGN  
FOR WRANGLER JK

Jeep® JK shown features Slant Hard Top installed with a XRC Gen2 Tire Carrier (76857) and Slant Tire Carrier Adapter (76857-05).



## SLANT HARD TOP

- Aggressive, stylish appearance for both on- and off-road
- Two-piece design with removable targa top front section for moonroof
- Rigid, hand-laid, honeycomb fiberglass construction for extra strength and rigidity
- Better performance through Increased departure angles when used with slanted tire carriers
- Better sound protection than stock hard top
- Jeep® JK 2-Door version has 65° slant; JK 4-Door version has 45° slant
- DOT-approved safety glass with 31% tint
- Rear window defroster included
- Dual rear hydraulic lift struts
- Hand fitted, military-spec, mildew-resistant carpeted interior
- Textured black grain finish with thick, UV-stable gel coat
- Provisions for rear wiper included



*PLEASE NOTE: The Slant Tire Carrier Adapter (76857-05) installed on a Pivot HD Tire Carrier (2843) is not compatible with the Slant Hard Top.*



**LIFETIME**  
STRUCTURAL  
**5-YEAR** FINISH  
WARRANTY

SLANT HARD TOP		
YEAR	MODEL	PART#
07-18	Wrangler JK 2-DR	517703
07-18	Wrangler JK 4-DR	518703

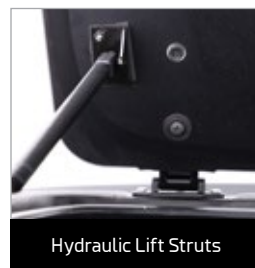
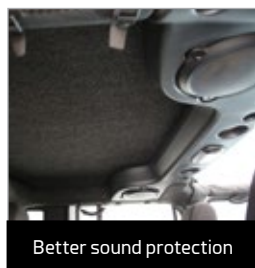



GET THE ORIGINAL

# HARD TOPS



Made in the USA



Removable canopy (JKs)

**2** PIECE DESIGN  
FOR WRANGLER JK

**LIFETIME**  
STRUCTURAL  
**5-YEAR** FINISH  
WARRANTY

## HARD TOP FOR JK, TJ

When you're looking for the quietest and highest quality top ever produced, look to Smittybilt to have you covered up!

- Honeycomb, hand-laid fiberglass for extra strength and rigidity
- Contoured DOT-approved safety glass – 31% Tint
- Military spec mildew-free carpeted headliner
- Thickest UV stable gel coat available
- Textured grain finish complementing the looks of today's Wranglers
- OE-style front latching mechanism
- New and improved aerodynamic shape
- De-tuned air vent
- Available with or without upper doors
- Fits factory Jeep JK and TJ



**1** PIECE DESIGN  
FOR WRANGLER TJ

HARD TOPS			
YEAR	MODEL		PART#
07-18	Wrangler JK 2-DR	Hard Top 2-Piece	517701
07-18	Wrangler JK 4-DR	Hard Top 2-Piece	518701
97-06	Wrangler TJ	Hard Top 1-Piece	519701
97-06	Wrangler TJ	Hard Top 1-Piece w/Doors	519801

## HARD TOP HOIST

- Includes 200 AMP 1/3 HP AC winch that lifts up to 440 lbs
- Exclusive Easy-Glide wheels
- Built-in limit stops and internal brake
- Exclusive rear window bracket allows hooking rear of top without window distortion
- Compatible with 2 and 4-door JKs, YJ and TJ
- Integrated storage included for JK Freedom Top panels
- Frame, electric winch and all hardware included
- Cable length: 39ft.

PLEASE NOTE: Not compatible with w/ LJ model and Safari Top



Easy-Glide Wheels



HARD TOP HOIST	
YEAR	PART#
ALL	510001





Smittybilt is proud to offer the most advanced Soft Top material in the industry...



Smittybilt's all new ProT3k fabric offers exceptional cold-weather performance with ability to handle frigid temperatures. The 37 oz. multi-layered, wrinkle-free material is 24% thicker than OE specs and has three layers of features:

**Top Layer:** Exterior striped outer canvas with sleek European styling

**Center layer:** Core of rubber/PVC provides waterproof protection

**Interior layer:** Luxurious cotton canvas lowers ambient road noise

Our traditional Black Diamond canvas has been (and still is) the stalwart workhorse of soft tops, but if you want to take your Jeep® into the extremes, look no further than ProT3K:



Shown: ProT3k Replacement Soft Top on Wrangler JK

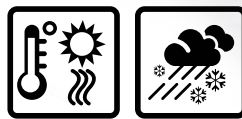

Heavy duty zipper



Shown with factory Sunrider feature



Heat-sealed stitches and seams



Fade and stretch resistant



Front internal storage compartments

**PROT3K REPLACEMENT SOFT TOP**

Smittybilt's all new ProT3K Replacement Soft Top offers exceptional cold-weather performance with the new ProT3K triple-layered material. These tops feature high definition, 40ml DOT vinyl windows for reduced noise and extended soft top life.

- Premium ProT3K material
- Tinted clear, high definition 40ml DOT vinyl windows
- Uses factory mounting points
- Seams and stitch holes are heat-sealed to prevent leaking
- Self-correcting zippers run smoother and last longer

<p><b>37oz.</b> Multi layered wrinkle free fabric</p> <p><b>40-mil.</b> D.O.T.- Approved tinted vinyl window</p> <p>TRIPLE LAYERED FOR ULTIMATE INSULATION AND NOISE REDUCTION</p> <p><b>FIRST LAYER</b> Exterior stripe canvas with European styling</p> <p><b>CENTER LAYER</b> Rubber / PVC for maximum waterproof protection</p> <p><b>BOTTOM LAYER</b> Smooth cotton canvas for maximum noise reduction</p> <p><b>-22°F Exceeds SAE J323B standards</b></p> <p><b>10db</b> Quieter than standard top</p>	<p><b>28oz.</b> Marine grade, OEM diamond style material</p> <p><b>30-mil.</b> D.O.T.- Approved tinted vinyl window</p> <p>DUAL LAYERED FOR PROTECTION</p> <p><b>FIRST LAYER</b> Durable black diamond PVC vinyl</p> <p><b>BOTTOM LAYER</b> Heavy-duty polyester material</p> <p><b>EQUAL TO O.E. SPECS</b></p>
--	---

PROT3K REPLACEMENT SOFT TOPS			OPTIONAL ACCESSORIES			
YEAR	MODEL	PART#	O.E. STYLE BOW ASSEMBLY	DOOR SURROUNDS	TAILGATE BAR	WINDSHIELD HEADER
97-06	Wrangler TJ	9974235	-	91404	-	90104
07-09	Wrangler JK 2-DR	9074235	91305	91405	91205	90105
07-09	Wrangler JK 4-DR	9084235	91306	91406	91205	90105
10-18	Wrangler JK 2-DR	9076235	91305	91405	91205	90105
10-18	Wrangler JK 4-DR	9086235	91306	91406	91205	90105

Please turn to page 80 for our traditional Black Diamond Tops for JKs, TJs and other applications

**SMITTYBILT**

GET THE ORIGINAL

# BOWLESS COMBO TOP KIT

The most adaptable Jeep® top on the market – now available as a complete kit

**SMITTYBILT**  
NEW PRODUCT



The Bowless Combo Top Kit from Smittybilt is the most adaptable Jeep® top on the market. If you're hitting the trail and clouds roll in unexpectedly you can quickly transform your Jeep so it is protected with a weatherproof full top. When the sun returns, simply zip out the side and rear windows and you're back to crawling in the open air again.

To make it even easier to enjoy this remarkable top, Smittybilt is now offering the complete Bowless Combo Top kit, which includes everything you need to install it on your TJ or JK.

- Functions as primary full top – Convertible to extended top with removable side/rear windows
- DOT-approved tinted vinyl windows
- Easy storage and packing of side curtains
- Heavy duty buckle system prevents flapping
- Front internal storage compartments for easy access
- Self-correcting zippers run smoother and last longer
- Seams and stitch holes are heat-sealed to prevent leaking
- Top and accessories can be purchased separately if needed

**Available in two choices:**

- 1) Black Diamond: Marine grade, OEM diamond style material
- 2) Premium PROT3K multi-layered, wrinkle-free fabric (for 4-door JKs)

FULL TOP • TWO-IN-ONE • EXTENDED TOP

**1**  
**2**

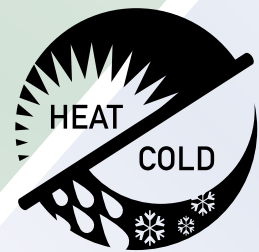

Fully open for hot, summer days



Partly opened for warm days



Closed tight for cold weather







Shown: Black Diamond  
Bowless Combo - Wrangler TJ

## 2 DURABLE CHOICES

ProT3K Trident Structure	BLACK DIAMOND
<b>37oz.</b> Multi layered wrinkle free fabric	<b>28oz.</b> Marine grade, OEM diamond style material
<b>40-mil.</b> D.O.T.- Approved tinted vinyl window	<b>30-mil.</b> D.O.T.- Approved tinted vinyl window
<b>TRIPLE LAYERED FOR ULTIMATE INSULATION AND NOISE REDUCTION</b> 	<b>DUAL LAYERED FOR PROTECTION</b> 
<b>FIRST LAYER</b> Exterior stripe canvas with European styling  <b>CENTER LAYER</b> Rubber / PVC for maximum waterproof protection <b>BOTTOM LAYER</b> Smooth cotton canvas for maximum noise reduction	<b>FIRST LAYER</b> Durable black diamond PVC vinyl  <b>BOTTOM LAYER</b> Heavy-duty polyester material
<b>-22°F Exceeds SAE J323B standards</b> <b>-30°C</b>	<b>EQUAL TO O.E. SPECS</b>
<b>10db</b> Quieter than standard top	

### Bowless Combo Top Kit includes:

Top, hardware, plus...

- A** Windshield Channel
- B** Driver side surround
- C** Passenger side surround
- D** Tailgate channel

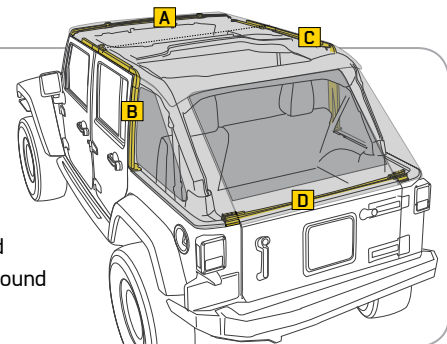

YEAR	MODEL	BOWLESS COMBO TOP KIT		TOP ONLY		OPTIONAL ACCESSORIES		
		Black Diamond	ProT3K Top	Black Diamond	ProT3K Top	Door Surrounds	Tailgate Bar	Windshield Header
97-06	Wrangler TJ			9973235	-	91404	-	90104
07-18	Wrangler JK 2-DR	9073235K		9073235	-	91405	91205	90105
07-18	Wrangler JK 4-DR	9083235K	9087235K	9083235	9087235	91406	91205	90105

Note: This top requires the use of the factory door surrounds and tailgate bar, as well as a header windshield channel. The Bowless Combo Top Kit contains all of these parts. If you need some – but not all – of the parts, they can be purchased separately under "optional accessories".



Internal storage compartments



DOT approved tinted vinyl windows



Fade and stretch resistant



Easy storage of side curtains



GET THE ORIGINAL

# REPLACEMENT SOFT TOPS

## REPLACEMENT SOFT TOPS

- 30mil DOT-approved tinted vinyl windows
- Fits over original factory OE/Smittybilt hardware/framework
- Seams are heat sealed to prevent leaking
- Self correcting zippers run smoother and last longer



30mil DOT-approved tinted vinyl windows



Heavy duty zipper



Self correcting zippers

REPLACEMENT TOPS					
YEAR	MODEL	DENIM BLACK	DENIM GRAY	DENIM SPICE	BLACK DIAMOND
97-06	Wrangler TJ w/Door Skins	-	-	9970217	9970235
88-95	Wrangler YJ w/Door Skins	9870215	9870211	9870217	-
07-09	Wrangler JK 2-DR	-	-	-	9070235
07-09	Wrangler JK 4-DR	-	-	-	9080235
10-18	Wrangler JK 2-DR	-	-	-	9075235
10-18	Wrangler JK 4-DR	-	-	-	9085235

REPLACEMENT TOPS				
YEAR	MAKE	MODEL	WHITE	BLACK
86-94	Suzuki/Geo	Sidekick / Tracker	98752*	98715*
86-94	Suzuki	Samurai	98652*	98615*

REPLACEMENT TOPS WITH ZIPOUT SIDE/REAR WINDOWS				
YEAR	MAKE	MODEL	WHITE	BLACK
86-94	Suzuki/Geo	Sidekick / Tracker	98952**	98915**
86-94	Suzuki	Samurai	98552**	98515**

\*Clear windows \*\* Tinted windows



## DOOR SKINS

- Fits over original factory framework
- OE hardware/bow assembly required

DOOR SKINS				
YEAR	MODEL	SKINS ONLY	LEFT SKINS w/FRAME	RIGHT SKINS w/FRAME
97-06	Wrangler TJ	897XX	794XX	795XX
87-95	Wrangler YJ	896XX	894XX	895XX





## OE-STYLE DOOR SURROUNDS

- Works with all Smittybilt tops
- Works with cable and clip in-style tops
- JK4D comes with six knobs, JK 2-door comes with four knobs
- Uses existing factory locations
- OE-style foam gaskets

*NOTE: Converting an OE hard top to soft top will require door surrounds, bow assembly (below) and tailgate bar.*

O.E. STYLE DOOR SURROUNDS		
YEAR	MODEL	PART#
97-06	Wrangler (TJ)	91404
07-18	Wrangler (JK) 2-DR	91405
07-18	Wrangler (JK) 4-DR	91406



Threaded brass inserts for easy use and corrosion prevention



Shown with Smittybilt OE-Style Bow Assembly (see below for details)



JK 4-door comes with six knobs, JK 2-door comes with four knobs



Works with cable and clip-in-style tops

## OE-STYLE BOW ASSEMBLY

Smittybilt offers a variety of OE-style replacement soft top parts for the 07-18 Jeep Wrangler and Unlimited for a fraction of the cost from the OE Dealer.

If you've damaged your bow assembly or just need a door surround for either the driver or passenger side of your Wrangler, you can count on Smittybilt to get your soft top back to its OE-quality.

- CNC bent to exacting specifications
- Powdercoated to match OE finish
- Uses existing factory locations
- Some drilling or modifications required

*NOTE: Converting an OE hard top to soft top will require door surrounds, (above) bow assembly and tailgate bar.*



O.E-STYLE BOW ASSEMBLY		
YEAR	MODEL	PART#
07-18	Wrangler (JK) 2-DR	91305
07-18	Wrangler (JK) 4-DR	91306



O.E. STYLE TAILGATE BAR (NOT SHOWN)		
YEAR	MODEL	PART#
97-06	Wrangler (TJ)	91204
07-18	Wrangler (JK) 2/4-DR	91205



GET THE ORIGINAL

## SOFT GOODS BRIEFS, COVERS, WIND BREAKERS



### SOFT GOODS

Smittybilt's now offering a complete line of OE quality soft goods accessories for the 2007-16 Jeep Wrangler & Unlimited. All of our soft goods start out digitized and are then cut from a CNC plotter which guarantees you'll receive a perfect fit every time. All of our Smittybilt materials are pressed out to our specifications so you can be assured you get the highest quality with the best finish possible.

#### A EXTENDED TOP (LONG BRIEF)

- Protection from the elements for front and rear passengers
- Constructed of same durable materials as our Standard Top
- Windshield channel required for installation
- Attach to rear with J-Clips and buckles



EXTENDED TOP			
YEAR	MODEL	DESCRIPTION	PART#
10-18	Wrangler JK 2-DR	Extended Top - Black Diamond	94235 £
10-18	Wrangler JK 4-DR	Extended Top - Black Diamond	94635 £
07-09	Wrangler JK 2-DR	Extended Top - Black Diamond	94135 £
07-09	Wrangler JK 4-DR	Extended Top - Black Diamond	94135 £
92-95	Wrangler YJ	Extended Top (11), (15), (17)	929XX §
97-06	Wrangler TJ	Extended Top (15), (17) (35) (36)	936XX *
04-06	Wrangler LJ	Extended Top - Black Diamond	93735

#### B STANDARD TOP (BRIEF)

- New design eliminates rear straps, so they won't flap in the breeze or interfere with back seat passengers
- Provides cover from sun, but keeps cab open to fresh air
- Available in colors to match interior and exterior accessories

STANDARD TOP			
YEAR	MODEL	DESCRIPTION	PART#
55-75	M38A1, CJ5	Strap Style - Black	90501 §
76-86	Wrangler CJ	Standard Top - Black	90701 §
87-91	Wrangler YJ	Standard Top (01), (11), (15)	908XX §
92-95	Wrangler YJ	Standard Top (11), (15), (17)	928XX §
97-06	Wrangler TJ, LJ Unltd	Standard Top (15), (17), (35), (36)	933XX *

#### C-D TONNEAU COVER & JK EXTENSION

- Tight fit eliminates flapping in the breeze
- Protect gear from the elements and prying eyes
- Boots seal around roll bar with Hook and loop fastener

TONNEAU COVER			
YEAR	MODEL	DESCRIPTION	PART#
07-18	Wrangler JK 2-DR	Tonneau Cover - Black Diamond	761235
07-18	Wrangler JK 4-DR	Tonneau Cover - Black Diamond	761335
97-06	Wrangler TJ	Tonneau Cover (15),(17),(35),(36)	7610XX
04-06	Wrangler LJ Unltd	Tonneau Cover - Black Diamond	761135
87-91	Wrangler YJ	Tonneau Cover (11), (15) w/ factory soft top channel mount	7010XX
92-95	Wrangler YJ	Tonneau Cover (11), (15),(17) w/ factory soft top channel mount	7210XX

TONNEAU COVER JK EXTENSION			
YEAR	MODEL	DESCRIPTION	PART#
07-18	Wrangler JK 4-DR	Tonneau Extension - Black Diamond	761435

#### E WINDSHIELD CHANNELS

WINDSHIELD CHANNELS			
YEAR	MODEL	MODIFICATIONS	PART#
07-18	Wrangler JK 2/4-DR	No drilling required	90105
97-06	Wrangler TJ	No drilling required	90104
76-95	Wrangler CJ,YJ	Drilling required	90101



# SOFT GOODS BRIEFS, COVERS, WIND BREAKERS

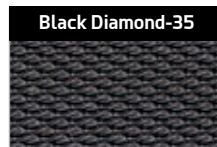

## F JK TAILGATE BAR

- Keeps soft top rear window or tonneau cover securely locked into place
- Works with soft tops and soft good accessories from all manufacturers
- Nylon reinforced retainer clips included. Easy installation, no drilling

JK TAILGATE BAR			
YEAR	MODEL		PART#
07-18	Wrangler JK	JK Tailgate Bar - OE-style replacement	91205

## G OUTBACK WIND BREAKER

- Deflects air up and over passenger area, reduces draft, noise and moisture
- Clear plastic windows for great rear visibility
- Attaches to roll bar, lower cutout is secured with zipper

OUTBACK WIND BREAKER			
YEAR	MODEL		PART#
07-18	Wrangler JK 2-DR	Outback - Black Diamond	90235
07-18	Wrangler JK 2-DR	Outback - Khaki Diamond	90236
07-18	Wrangler JK 4-DR	Outback - Black Diamond	90335
07-18	Wrangler JK 4-DR	Outback - Khaki Diamond	90336
76-06	Wrangler CJ, LJ Unltd	Outback (11)(15)(17)(35)(36)	900XX

## H SPARE TIRE COVER

JEEP SPARE TIRE COVERS (ALL MODELS)		
YEAR	DESCRIPTION	PART#
76-18	27-29" Tire Cover, Medium, (01), (11), (15), (17), (35), (36)	7729XX
76-18	30-32" Tire Cover, Large, (01), (11), (15), (17), (35), (36)	7732XX
76-18	33-35" Tire Cover, Large, (11), (15), (35), (36)	7735XX
76-18	36-37/12.5" Tire Cover, X-Large, (11), (15), (35), (36)	7736XX

## I SOFT TOP STORAGE BOOT

- Protects soft top from sun when it's folded down
- Snaps down over soft top and bows

SOFT TOP STORAGE BOOT			
YEAR	MODEL	DESCRIPTION	PART#
97-06	Wrangler	Soft Top Storage Boot (15)	600015
07-18	Wrangler	2 DR Soft Top Storage Boot (35)	600135
07-18	Wrangler	4 DR Soft Top Storage Boot (35)	600235

## J OE-STYLE DOOR SURROUNDS

- Works with all Smittybilt tops
- Works with cable and clip in-style tops
- JK4D comes with six knobs, JK 2-door comes with four knobs
- Uses existing factory locations
- OE-style foam gaskets

O.E. STYLE DOOR SURROUNDS		
YEAR	MODEL	PART#
97-06	Wrangler TJ	91404
07-18	Wrangler JK, 2-DR	91405
07-18	Wrangler JK, 4-DR	91406



GET THE ORIGINAL

# MESH TOPS

## CLOAK MESH

THE COMPLETE LINE  
TOP | SIDES | REAR



Jeep TJ (shown)  
No Header Required



Jeep JK 4DR (shown)  
No Header Required

### CLOAK EXTENDED MESH TOP (LONG BRIEF)

Cloak Extended Mesh Top, which allows you to enjoy the open air in the shade of your Jeep's passenger compartment. Available for 97-06 Jeep Wrangler TJs and both two-and four-door 07+ Jeep Wrangler JKs.



Jeep JK 2DR (shown). No header required



Installs easily with heavy duty T-handle bungee cords



Reduces the heat and glare of the sun while allowing cool air to flow through



Provides privacy while reducing wind noise



Durable PVC-coated mesh that is both UV and mildew resistant

CLOAK EXTENDED MESH TOP		
YEAR	MODEL	TOP ONLY
07-18	Wrangler JK 2-DR	95100
07-18	Wrangler JK 4-DR	95500
97-06	Wrangler TJ	95600

CLOAK EXTENDED MESH SIDES / REAR		
YEAR	MODEL	SIDES/REAR
07-18	Wrangler JK 2-DR	95101
07-18	Wrangler JK 4-DR	95501
97-06	Wrangler TJ	95601



No need to remove you top – the Cloak will fit under hard tops and soft tops



Versatile combinations of top, side and rear



## EXTENDED MESH TOP (LONG BRIEF)

When it's time to play and you want a quick and simple way to stay out of the sun look to Smittybilt to have you covered up with the Extended Mesh Top. It gives you the best of both worlds – it reduces the heat and glare of the sun while allowing the cool air to flow through the unique mesh design.

The durable UV-treated material, oversized heavy duty nylon webbing and buckles will provide a lifetime of service.

- Manufactured out of durable UV-treated material
- Heavy duty nylon webbing with reinforced cross stitching
- Heavy duty buckles made out of reinforced nylon – designed to last forever
- Extended top versions will cover front and rear seats
- New design eliminates the need for a rear strap so they won't flap in the breeze
- 3 Year Limited Warranty

NOTE: Windshield channel required (sold separately)

MESH EXTENDED TOP			
YEAR	MODEL	DESCRIPTION	PART#
07-09	Wrangler JK 2-DR	Mesh Extended Top	94100*
10-18	Wrangler JK 2-DR	Mesh Extended Top	94200*
07-09	Wrangler JK 4-DR	Mesh Extended Top	94500*
10-18	Wrangler JK 4-DR	Mesh Extended Top	94600*
97-06	Wrangler TJ	Mesh Extended Top	93600**
07-18	Wrangler JK 2/4-DR	Windshield Channel*	90105
97-06	Wrangler TJ	Windshield Channel**	90104



## C.RES CARGO RESTRAINT SYTEM

When you're charging through the hammers, the last thing you want is your gear flying out. To avoid this, look to Smittybilt to provide you with a cargo restraint system. The C.RES top is manufactured out of OE soft top material, which is durable and will last you a lifetime. With a rear zippered curtain you're not limited to the size cargo you can carry.

- Mounts into the factory belt rail channel and straps around the factory roll bar for perfect fit
- OE diamond black finish
- Industrial grade zippers

Please note: TJ/YJ applications require factory tailgate channel\*. JK applications require Smittybilt tailgate bar (or factory tailgate channel)\* and factory door surround†.



C.RES CARGO RESTRAINT SYSTEM			
YEAR	MODEL	DESCRIPTION	PART#
92-95	Wrangler YJ	C.RES Cargo Restraint System	521035*
97-06	Wrangler TJ	C.RES Cargo Restraint System	561035*
07-18	Wrangler JK 2-DR	C.RES Cargo Restraint System	571035*†
07-18	Wrangler JK 4-DR	C.RES Cargo Restraint System	581035*†
07-18	Wrangler JK 2/4-DR	JK Tailgate Bar*	91205



GET THE ORIGINAL

# CARGO RESTRAINT



## C-RES<sup>2</sup> HD CARGO RESTRAINT SYSTEM HEAVY-DUTY

### C-RES<sup>2</sup> HD CARGO RESTRAINT SYSTEM

The newly designed C-RES<sup>2</sup> Heavy Duty top features 2-inch military grade polyester webbing with an amazing 1,200 lbs of tensile strength.

- Works with most hardtops or soft tops
- Easy to install with no tools required - does not interfere with factory mounting points
- Rugged, triple stitched 2-inch polyester webbing
- Provides coverage from the sound bar to the tailgate

#### C-RES<sup>2</sup> HD CARGO RESTRAINT SYSTEM

YEAR	MODEL		PART#
97-06	Wrangler TJ	C-RES <sup>2</sup> Cargo Restraint System	561135
07-18	Wrangler JK 2-DR	C-RES <sup>2</sup> Cargo Restraint System	571135
07-18	Wrangler JK 4-DR	C-RES <sup>2</sup> Cargo Restraint System	581135



Quick release access to cargo area



Steel grommets for extra hook points



Side & rear curtains included



Nylon reinforced buckles



## CAB COVERS

Constructed with new space age fabric, Climate Cover protects your vehicle from the elements while allowing the paint to breathe. Soft and durable fabric pampers paint finish and protects from sun, dirt, dust, moisture and pollution with a unique diamond bond pattern allowing damaging trapped air & moisture to escape, preventing paint deterioration. UV protection against sun and heat buildup, spun bond polypropylene is naturally water repellent and double-stitched elastic hems for a custom fit.

Heavy-duty grommet, bag, lock and cable included.

- Constructed of durable, water-resistant material
- Protects your vehicle's interior from the elements
- Our water-resistant Cab Cover installs in just seconds and fits snugly over the windshield frame and roll bar for a custom fit
- For proper fit, soft top must be lowered



Part# 835

### FULL COVER ONLY:

Includes:

- Storage Bag
- Heavy-Duty Grommet
- Lock & Cable
- Mirror Pockets



Part# 1069



Part# 1068

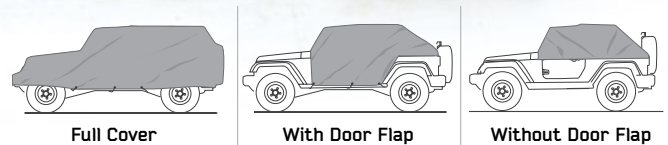

Full Cover

With Door Flap

Without Door Flap

### JEEP COVERS

YEAR	MODEL	COLOR	FULL COVER	W/DOOR FLAP	W/O DOOR FLAP
76-86	Wrangler CJ	Gray	803	1059	1159
87-95	Wrangler YJ	Gray	803	1060	1160
97-06	Wrangler TJ	Gray	803	1061	1161
97-06	Wrangler TJ	Spice	803	1067	1167
04-06	Wrangler LJ Unltd	Gray	825	----	----
07-18	Wrangler JK 2-DR	Gray	830	1068	----
07-18	Wrangler JK 4-DR	Gray	835	1069	----



# STORAGE BAGS



JK Hard Door Storage Bag

JK Soft Top Storage Bag

## STORAGE BAGS

The heat's here and it's time to take your soft top and doors off for the summer. Smittybilt now offers a new storage bag that fits the Jeep Wrangler & Unlimited. Each bag is manufactured out of 600 denier ballistic nylon and designed to be the perfect storage system for your soft top or hard doors.

SOFT TOP STORAGE BAG



WINDOWS TOP STORAGE BAG



HARDTOP STORAGE BAG



### SOFT TOP STORAGE BAG

- Use this handy bag to carry or protect your soft top when it's not in use
- Separate pockets for rear window, side curtains
- Bow protectors covers
- Made out of 600 denier ballistic nylon

SOFT TOP STORAGE BAG		
YEAR	MODEL	PART#
07-18	Wrangler JK 2/4-DR	596001
76-06	Wrangler CJ, YJ, TJ	595001

### WINDOW STORAGE BAG

- Protect your windows while they are zipped out of your top
- Stores and protects side windows and framed soft upper doors
- Includes foam padding to prevent scratching

WINDOWS STORAGE BAG		
YEAR	MODEL	PART#
76-18	Wrangler CJ, YJ, TJ, JK	595101

### HARD DOOR STORAGE BAG

- The easiest and most convenient way to carry and protect full hard doors when not in use
- Soft inner foam padding keeps paint from scratching
- Sold in pairs (one bag per door)

HARD DOOR STORAGE BAG		
YEAR	MODEL	PART#
07-18	Wrangler JK 4-DR	596301
76-06	Wrangler CJ, TJ, YJ	595201





**XRC PERFORMANCE SEATS**

This lineup of race seats was developed for the true off-road enthusiast who demands the very best in suspension seat technology. Each XRC seat starts off with a Kodiak frame which is one of the strongest tubular frames in the industry. A high performance foam pack with a contoured single suspension liner provides the ultimate in comfort and quality. Each seat is covered with mil spec fabric and vinyl material. With its fixed headrest design and fully adjustable reclining system, the XRC Seat gives the look and performance needed for every situation. Matching rear seat covers for Jeep Wranglers applications also available.

- Dimensions: Height 34.50", Width 20.50", Depth 24.50"
- Mounts up to CJ / YJ applications directly to the factory sliders
- TJ / JK applications require additional brackets. Sold separately - see page 81.

<b>K</b> FRAME KODIAK FRAME	<b>S</b> POINT 5 POINT HARNESS	<b>M</b> MIL SPEC MIL SPEC FABRIC	<b>EZ</b> INSTALL EASY INSTALL	<b>HP</b> FOAM PACK HIGH PERF FOAM PACK
-----------------------------------	--------------------------------------	---	--------------------------------------	---

XRC FRONT SEATS					
YEAR	MODEL	DESCRIPTION	BLACK/BLACK	GRAY/BLACK	RED/BLACK
76-18	Wrangler	XRC Suspension Seat - Right Side	750115	750111	750130
76-18	Wrangler	XRC Suspension Seat - Left Side	750215	750211	750230

XRC REAR SEAT COVERS					
YEAR	MODEL	DESCRIPTION	BLACK/BLACK	GRAY/BLACK	RED/BLACK
2007	Wrangler JK 4-Door	XRC Rear Seat Cover	758115	758111	758130
08-12	Wrangler JK 4 Door	XRC Rear Seat Cover	758215	758211	758230
13-18	Wrangler JK 4-Door	XRC Rear Seat Cover	758115	758111	758130
07-18	Wrangler JK 2-Door	XRC Rear Seat Cover	759115	759111	759130
03-06	Wrangler TJ	XRC Rear Seat Cover	757115	757111	757130
97-02	Wrangler TJ	XRC Rear Seat Cover	756115	756111	756130
80-95	Wrangler YJ	XRC Rear Seat Cover	755115	755111	755130

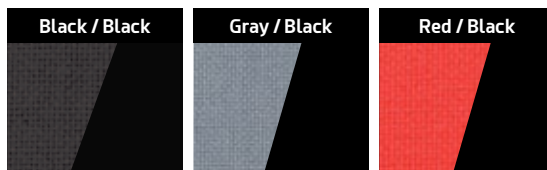



GET THE ORIGINAL

# REPLACEMENT SEATS

When you're looking for a quality replacement seat, go with one from Smittybilt. Each seat is manufactured to the exact specifications OE's require and features poured foam which provides the proper density needed in key areas of the seat. Seats are manufactured from a tubular frame and then powdercoated for long life. The trim cover is the toughest in the industry and is available in a variety of colors to complement your Jeep®. Each front seat is available in either a classic fixed back style or recliner to provide the optimum in comfort.



A

## A LOW BACK BUCKET SEATS

- Rugged, contoured seats with firm spring suspension for early-model CJs
- Installation is quick and easy – these bucket seats use the same mounting hardware and bolts from the original seat.
- Dimensions: Height 22", Width 19.75", Seat Depth 20"

NOTE: Some modification may be required

LOW BACK BUCKET SEAT		
YEAR	MODEL	PART#
55-76	CJ	44801*



B

## B STANDARD BUCKET SEAT

- Economical solutions to replacing worn factory seats
- Available in the same colors
- Rugged, deeply contoured seats with firm comfortable spring suspension
- Dimensions: Total Height 29.5", Width 19", Seat Depth (front to back) 19"

NOTE: 1997-2006 requires specific brackets. See adapter brackets on next page.

STANDARD BUCKET SEAT		VINYL		DENIM	
YEAR	MODEL	BLACK	GRAY	BLACK	SPICE
76-06	Wrangler CJ, TJ, YJ	44901	44911	44915	44917



C

## C FACTORY REPLACEMENT SEAT W/ RECLINER

- Available with or without comfortable fabric facing to keep you cool in the summer and warm in the winter
- Dual recliner mechanism to allow seat to function on either side
- Comfortable spring suspension and custom molded foam
- Bolts directly to factory mounts without drilling
- Dimensions: Height 32.75", Width 20", Seat Depth 20.25"

NOTE: 1997-2006 requires specific brackets. See adapter brackets on next page.

FACTORY REP. SEAT w/ RECLINER		VINYL		DENIM	
YEAR	MODEL	BLACK	GRAY	BLACK	SPICE
76-06	Wrangler CJ, L J, TJ, YJ	45001	45011	45015	45017



D

## D CONTOUR SPORT SEAT

- Incorporates adjustable headrest for added comfort
- Extra-thick foam sides and bolsters cradle you in the seat
- Welded powdercoated seat frame will not rust or break
- Extra heavy-duty suspension spring dampens bumps
- Infinite reclining system with knobs on both sides of seat
- Highest quality, dense foam for long life and extra comfort
- Height 33" w/ headrest 36", Width 21", Seat Depth 21.25"

NOTE: 1997-2006 requires specific brackets. See brackets on next page.



[ C.-D.] Reclining knobs on both sides of seat allows seat to function on either side

CONTOUR SPORT SEAT		VINYL		DENIM	
YEAR	MODEL	BLACK	GRAY	BLACK	SPICE
76-06	Wrangler CJ,TJ,YJ	49501	49511	49515	49517





# REPLACEMENT SEATS



**F** 41301

## **F** REAR FOLD & TUMBLE SEAT

- When cargo space is needed, just fold-and-tumble it forward and store it out of the way behind your front seat
- Easy Install with minimal drilling
- Durable vinyl or full fabric front that matches Smittybilt's front seat fabrics
- CJ/YJ Seat Dimensions:  
Height 22.5", Width 33.5",  
Seat Depth (front to back) 21"
- TJ Seat Dimensions:  
Height 22.5", Width 40.5",  
Seat Depth (front to back) 21"

Note: Fits CJ, YJ and TJ only.  
\*Does not work with LJs



FOLD & TUMBLE SEAT		VINYL		DENIM	
YEAR	MODEL	BLACK	GRAY	BLACK	SPICE
86-95	Wrangler CJ, YJ	41301	41311	41315	41317
97-06	Wrangler TJ only*	N/A	41511	41515	41517



**F** 41511

**F** 41517

## **G** STANDARD REAR SEAT

- Steel tubular frame covered with tailored pleating for attractive appearance
- Thick, padded cushions look great and feel comfortable
- Mounts easily, minimal drilling
- Brackets included
- Dims: Height 20", Width 33.5", Seat Depth (front to back) 19"

FOLD & TUMBLE SEAT		VINYL		DENIM	
YEAR	MODEL	BLACK	GRAY	BLACK	SPICE
55-95	CJ & Wrangler	8001N	8011N	8015N	8017N



**G** 8015N

**G** 8017N



## SEAT ADAPTER BRACKETS



SEAT ADAPTER BRACKETS			FRONT		REAR
YEAR	MODEL	DESCRIPTION	DRIVER	PASSENGER	
55-71	CJ5	Front Seat Adapter Brackets	49910	-	-
55-71	CJ5	Front Seat Adapter Brackets	-	49911	-
72-75	CJ5	Front Seat Adapter Brackets	49912	-	-
72-75	CJ5	Front Seat Adapter Brackets	-	49913	-
07-18	Wrangler JK 2/4-DR	Front Seat Adapter Brackets (Pair)	49906 (Pair)		-
07-18	Wrangler JK 4-DR	Rear Seat Adapter Brackets	-	-	49905
03-06	Wrangler TJ, LJ Unltd	Front Seat Adapter Brackets -XRC Seat only	49902*	49903*	-
97-02	Wrangler TJ	Front Seat Adapter Brackets	49900	49901	-

\*XRC seats only



GET THE ORIGINAL

## SEAT COVERS



Black/Black - 471601    Red/Black - 471630    Charcoal/Black - 471622    Tan/Black - 471625



**NOW AVAILABLE AS A COMPLETE SET FOR FRONT AND REAR!**

### NEOPRENE SEAT COVER SETS

Custom fit Smittybilt Neoprene Seat Covers provide an extra layer of protection and style for those looking to either refurbish old, worn seats or help keep new ones in pristine condition – all at an affordable price.

NEOPRENE SEAT COVER SETS (INCLUDES FRONT AND REAR)					
YEAR	MODEL	BLACK	CHARCOAL	TAN	RED
13-18	JK 2 Door	471501	471522	471525	471530
07-12	JK 2 Door	471401	471422	471425	471430
2007	JK 4 Door	471801	471822	471825	471830
08-12	JK 4 Door	471701	471722	471725	471730
13-18	JK 4 Door	471601	471622	471625	471630
03-06	TJ	471301	471322	471325	471330
97-02	TJ	471201	471222	471225	471230
91-95	YJ	471101	471122	471125	471130
76-90	YJ, CJ7	471001	471022	471025	471030



Sewn in map pocket



Recliner lever cutouts



Provisions for side airbags



60/40 split

### KATCH-ALL COVER

Smittybilt's complete offering of soft goods designed to fit your CJ, YJ, TJ and JK. The Katch-All cover protects factory seats from spills and wear-and-tear. Installation is easy with adjustable elastic bands. We use the highest quality material and back it with the strongest warranty. Sold in pairs.

KATCH-ALL SEAT COVERS		
YEAR	DESCRIPTION	PART#
76-06	Katch-All Seat Covers	56601*

\* Pairs of covers





## G.E.A.R. CUSTOM FIT SEAT COVERS

Smittybilt has released a new and improved range of Jeep seat covers featuring multi-layered 600 denier ballistic nylon for improved comfort, as well as waterproof functionality. These seat covers are custom made to fit snug to your Jeep seats for a clean and stylish look. To assist with storage solutions, these covers come with MOLLE/PALS webbing and various pouches and pockets. Five pouches of various sizes are included with front seat covers. Two large pouches (one with multi-compartments) are included with rear seats covers.



Front and Rear Pockets



Map/Flats Compartments



Five Storage Pouches (Front)



JK front



JK 2-Door rear



TJ rear

G.E.A.R. CUSTOM FIT (FRONT PAIR)			
YEAR	MODEL	POUCHES	PART #
13-18	Wrangler JK	5	56647701
07-12	Wrangler JK	5	56647801
03-06	Wrangler TJ, LJ	5	56647501
97-02	Wrangler TJ	5	56647001

G.E.A.R. CUSTOM FIT (REAR)			
YEAR	MODEL	POUCHES	PART #
07-18	Wrangler JK 2 DR	2	56656901
07 or 13-18	Wrangler JK 4 DR	2	56647901
08-12	Wrangler JK 4 DR	2	56646501
03-06	Wrangler TJ, LJ	2	56647601
97-02	Wrangler TJ	2	56647101



Two Large Storage Pouches (Rear)



# SEAT COVERS

## G.E.A.R. SEAT COVERS

The ultimate storage solution for your off-road vehicle! The G.E.A.R. seat cover is a completely new way of looking at storage for your off-road needs and fits factory and most aftermarket seats from 1976 to 2018. Each cover is completely adjustable and manufactured from 600 denier polyester with a PVC liner. Each seat includes pouches that fasten securely using a MOLLE/PALS Restraint System, which will not come loose under the harshest off-road conditions. Pouches can be moved around for ease of use or transferred to any backpack or bag with the MOLLE/PALS attachments. Seven pouches of various sizes are included with front seat covers. Five large multi-compartment pouches are included with rear seats covers. A removable American or Canadian flag is also included with each front seat cover as an added bonus! See part numbers on following page.



\*Please note: pouch contents (compass, tool, etc) are shown for illustration purposes only and are not included with pouches





# SEAT COVERS



Five multi-compartment pouches included with each rear seat cover

G.E.A.R. SEAT COVERS				
YEAR/MODEL	POUCHES	BLACK (01)	TAN (24)	GREEN (31)
76-18 Wrangler - Front*	7	5661001	5661024	5661031
76-06 Wrangler - Rear	5	5660201	5660224	5660231
Universal for Trucks - Front only*	6	5661301	5661324	5661331



\*Individual covers

\*Please note: pouch contents (compass, tool, etc) are shown for illustration purposes only and are not included with pouches



G.E.A.R. TAILGATE COVER				
YEAR/MODEL	POUCHES	BLACK (01)	TAN (24)	GREEN (31)
97-06 Wrangler	2	5662201	5662224	5662231
07-18 Wrangler	2	5662301	5662324	5662331



\*Please note: pouch contents (compass, tool, etc) are shown for illustration purposes only and are not included with pouches

## G.E.A.R. ACCESSORIES

G.E.A.R. accessories are manufactured from 600 denier polyester and are completely UV stable. Overhead consoles and tailgate covers feature individual MOLLE/PALS storage pouches with additional compartments inside. All pouches are interchangeable within the entire Smittybilt G.E.A.R. product family.



G.E.A.R. OVERHEAD CONSOLE				
YEAR/MODEL	POUCHES	BLACK (01)	TAN (24)	GREEN (31)
97-06 Wrangler	6	5665001	5665024	5665031
07-18 Wrangler	6	5666001	5666024	5666031



Hydration Pack works with G.E.A.R. Seat Covers or can be used as a backpack

G.E.A.R. HYDRATION PACK	
YEAR/MODEL	BLACK (01)
Hydration Pack (2 liter)	5661101



GET THE ORIGINAL

## ROLL BAR ACCESSORIES

### MOLLE SPORT BAR COVER KIT

Replace your worn and faded roll bar covers with Smittybilt's MOLLE roll bar covers.

- Three-piece kit
- 600 D striped canvas
- Foam-lined fabric
- Heavy duty zippers, and hook and loop fasteners
- Zipper and Hook and loop fastener closures for the ultimate fit
- MOLLE attachment points front and rear for extra storage space

Note: MOLLE bags & Padding not included



MOLLE SPORT BAR COVER KIT		
YEAR	MODEL	PART#
97-02	Wrangler TJ	5665101
03-06	Wrangler TJ	5665201
07-18	Wrangler JK 2-Door	5666101
07-18	Wrangler JK 4-Door	5666201



Cutouts for OE hardware

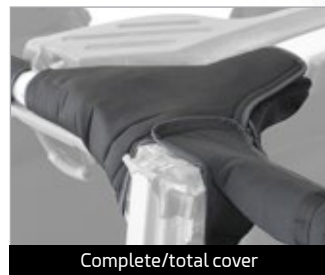

Complete/total cover



MOLLE/Pals webbing included



Durable high grade zippers

### FIRST AID KIT BAG

- Multiple pouches to store your first aid essentials
- Stored for easy access during emergencies or carried on the trail

NOTE: Bag only - contents not included



FIRST AID BAG	
DESCRIPTION	PART#
First Aid Kit Bag	769541

### COMP AIR ROLL BAR

(See page 131 for Comp-Air tank )



COMP-AIR ROLL BAR MOUNT	
DESCRIPTION	PART#
Comp-Air Tank - Roll Bar mount	2749





## ROLL BAR ACCESSORIES

From grab handles to drink holders, smartphone bags and more, Smittybilt offers every roll bar accessory you will need to make your driving experience as enjoyable and convenient as possible.

### JK GRAB HANDLE

- Extreme molded handle with ballistic nylon webbing for strength
- High strength steel grommets use factory mounting points and factory hardware
- Versatile multi-point applications: front pillars, headrest post and rear sides

JK GRAB HANDLE (Pair)	
YEAR/MODEL	PART#
07-18 Wrangler JK 2/4 DR	769311



### PREMIUM GRAB HANDLE

- Two MOLLE bags included

PREMIUM GRAB HANDLES (Pair)	
DESCRIPTION	PART#
Premium Grab Handles	769315



DESCRIPTION	PART#
Fire Ext. Holder 2.5lbs	769540



DESCRIPTION	PART#
Fire Ext. Holder 1lb	769530



(pair)

DESCRIPTION	PART#
Drink Holder	769901



DESCRIPTION	PART#
Mag Flash Light Holder	769520



DESCRIPTION	PART#
Mini Mag Light Holder	769550



(pair)

DESCRIPTION	PART#
Sport Handle	769201



(pair)

DESCRIPTION	PART#
Deluxe Sport Handle	769301



(pair)

DESCRIPTION	PART#
Extreme Sport Handle	769310



DESCRIPTION	PART#
Cell Phone Holder	769510



DESCRIPTION	PART#
Personal Device Holder	769560



GET THE ORIGINAL

# SECURITY

## INTERIOR STORAGE VAULT

Storage and security are always big-concerns for Jeepers. Smittybilt's new lockable storage vault features a solidly built drawer that has high-grade steel slides that offer smooth, quiet operation.

- 16-gauge cold rolled steel with Signature Series two stage black powdercoat finish
- Drawer supports up to 220 lbs.
- High grade steel sliders for smooth operation
- Ergonomically designed aluminum handle
- JK vault includes FREE Jack Bag for storing OE jack and accessories, made out of 600D ballistic nylon, heavy duty zipper and side pockets (jack and wrench not included)

NOTE: Vault does not work w/ subwoofer in floor



Smittybilt Jack Bag included



### INTERIOR STORAGE VAULT

YEAR/MODEL	PART #
76-06 Wrangler CJ7, YJ, TJ	2761
07-18 Wrangler JK	2763

Dimensions:  
2761 (W 34.4" x L 30" x 13"H.)  
2763 (W 34.4" x L 28" x 13"H.)



## OFF-ROAD ORGANIZER

- Special quad fold design holds maps, maintenance manuals, small flashlights, tools, tire gauges and other vehicle paperwork
- Clear card pocket keeps vehicle registration and insurance information handy

OFF-ROAD ORGANIZER	
DESCRIPTION	PART#
Fits all Wrangler glove boxes	769501



Mounts into O.E. holes



Heavy-Duty lock

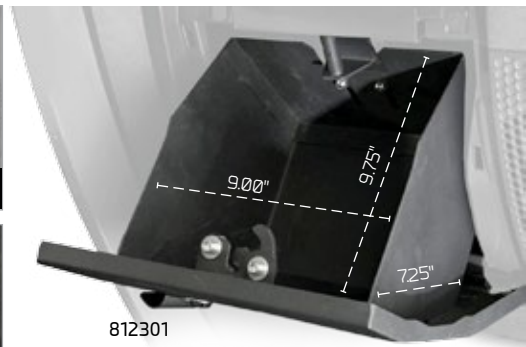

812301

## VAULTED GLOVE BOX

- Mounts into O.E. glove box hole and turns ordinary box into security vault
- Heavy duty, 16-gauge steel
- Locking compartment will secure your valuables and give you peace of mind during off-road adventures

VAULTED GLOVE BOX		
YEAR	MODEL	PART #
87-95	Wrangler YJ	812101
97-06	Wrangler TJ	812201
07-18	Wrangler JK	812301



"One night I left [my Jeep] parked at the Portland Airport for a few hours. Unfortunately, that was enough time for someone to think he could break in and rob me. Obviously armed with a crowbar the robber pried and pried unsuccessfully to gain access to the Smittybilt console. My tool kit and controller remain in my possession due to the Smittybilt floor console that was so well designed. Thank you for making such a great product."

— Marc and Michelle C.

**SECURITY FLOOR CONSOLE**

- 16-gauge steel for heavy-duty security
- Lockable security compartment protects your stereo, CD player, CB or scanner while you're away from your vehicle
- Black powdercoat base and color matched arm rests
- Includes dual adjustable front cup holders to fit all sizes of cups and bottles
- Bolts directly on to the floor, hardware included
- Fits between the seats of all '76-95 Jeep Wranglers



Stereo/CD compartment



Large Lockable Storage

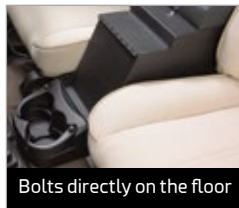

Bolts directly on the floor

SECURITY FLOOR CONSOLE (LOCKING)					
YEAR	MODEL	DESCRIPTION	BLACK	GRAY	SPICE
76-95	Wrangler CJ, YJ	Security floor console	31715	31711	31717
76-95	Wrangler CJ, YJ	Security stereo floor console	31815	31811	31817



**SECURE LOCK BOX**

- 14-gauge heavy-duty steel
- Universal mounting sleeve bolts directly on to the floor
- Dual-Lock system allows box to be removed from sleeve while locked
- Protect valuables while traveling
- Egg shell foam interior
- Dimensions: 8.25" x 9.25" x 3"

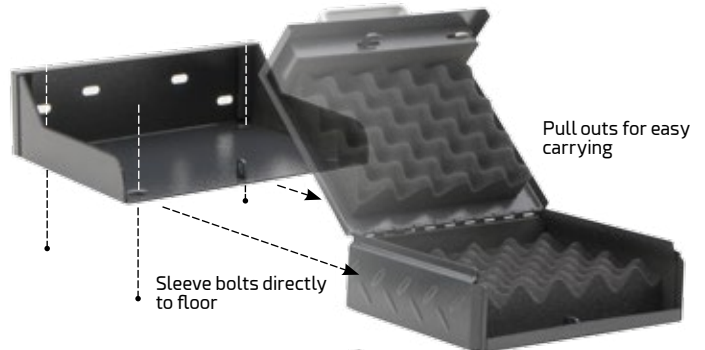

SECURE LOCK BOX	
YEAR/MODEL	PART #
Secure Lock Box	2746
Secure Lock Box Sleeve	2746-01





GET THE ORIGINAL

# ACCESSORIES



## LIMB RISER

Wheel worry-free from scratches or cracks on the windshield caused by branches



- Easy to adjust – keep cables tight with marine grade stainless steel turnbuckle
- 1/4-inch nylon-coated carbon steel cable
- Durable double powdercoated brackets (two for hood and two for windshield) to protect your paint
- All hardware included
- Minor drilling required
- Works with factory and aftermarket hood latches
- Smittybilt Advantage Warranty: 5-year finish and lifetime structural

YEAR	MODEL	PART#
07-18	Wrangler JK 2/4 Door	7611
97-06	Wrangler TJ	
84-01	Wrangler XJ	7613

## XRC FOOT PEGS

- Includes spring to lock in the dome light switch
- Exclusive bolt engagement to eliminate rattling
- Rubber trim gasket to reduce paint chips
- Aggressive styling winglets to help foot placement
- Made from 1/8" CNC steel
- JK models fit front and rear hinges; TJ models include dome light lock out spring
- Sold in pairs

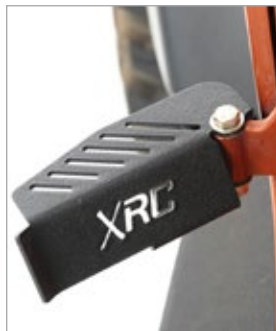

ALWAYS wear a seat belt when driving, but especially when you have removed the doors. Check your local rules of the road to be sure that driving without the doors is legal.

FOOTPEGS	PART#
Wrangler JK (front or rear)	7619
Wrangler 76-06	7620

## ATLAS DOOR STEPS

The new Smittybilt Atlas door steps combine safety, functionality and durability as surefooted solutions to offer easy access to Jeep roof racks and more. The non-slip, serrated steps install conveniently. Smittybilt Atlas body steps support a 350 lb. limit, making it a breeze to set up a rooftop tent on your Jeep. Additionally, these exterior accessories double as handles to help when removing doors and function as integrated tie down points.

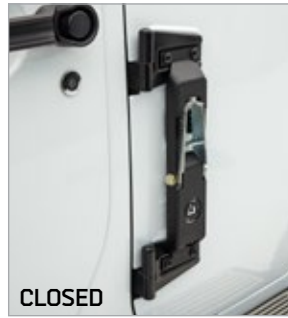

CLOSED



OPEN



Surefooted Solution to access your Jeep® rooftop

**SMITTYBILT**  
NEW PRODUCT

Easy Install No drilling required direct bolt on

Non-slip, serrated step design



- Safety
- Functionality
- Durability
- Sold in Pairs

YEAR	MODEL	PART#
07-18	Wrangler JK 2/4 Door	7630

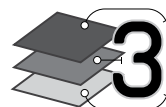

**3 STAGE TREATMENT**  
• Dual stage powdercoating  
• Special "E-Coat" inside & out  
• Acid dipped to remove impurities

**LIFETIME STRUCTURAL 5 YEAR FINISH WARRANTY**

**TEXTURED TB BLACK**



### WINDSHIELD HINGE LIGHT BRACKET

- Easy solution when extra light's needed
- Easy Install! Requires no drilling or modifications
- Finished in black powdercoat
- Sold in pairs – comes complete with all necessary hardware



YEAR	MODEL	PART#
07-18	Wrangler JK	7690
97-06	Wrangler TJ	7608

### LICENSE PLATE RELOCATION BRACKET

- Relocate your license plate to the center of your spare tire carrier
- Includes mounts for 2 auxillary lights
- Easy install



YEAR	MODEL	PART#
76-18	Wrangler CJ,YJ, TJ, JK, XJ	4434



### XRC LIGHT BAR ASSEMBLY

- Fully adjustable position
- 1.5" main crossbar can accommodate up to five 9" lights or 50" light bar
- Race-designed supports each made out of solid piece of cold rolled steel
- Easy install - requires no drilling or modifications to the vehicle
- Signature matte black powdercoat finish
- Ships three pieces UPS-able

**3 STAGE TREATMENT**  
 • Dual stage powdercoating  
 • Special "E-Coat" inside & out  
 • Acid dipped to remove impurities

**LIFETIME STRUCTURAL 5 YEAR FINISH WARRANTY**

**GLOSS GB BLACK**

YEAR	MODEL	PART#
97-06	Wrangler TJ	76910
07-18	Wrangler JK	76911

### TAILGATE TABLE

Make camping a breeze with the integrated tailgate table. Built-in cup holders and large surface area keep your food out of the dirt. Excellent place for your BBQ or small repair projects.

- Fits 2007-18 Jeep® JK
- Made of 1/8" steel, holds up to 40 lbs
- Low profile when closed
- Compatible with all Smittybilt swingaway tire carriers
- Drilling required for installation
- Mount with table top up or down, inside or outside of tailgate
- Includes mounting screws

YEAR	MODEL	PART#
97-06	Wrangler TJ	2793
07-18	Wrangler JK	2793



Stove and accessories not included

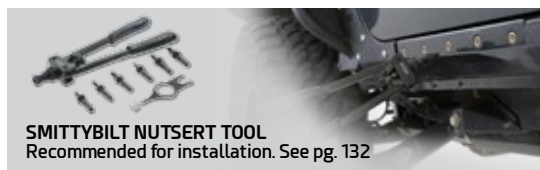
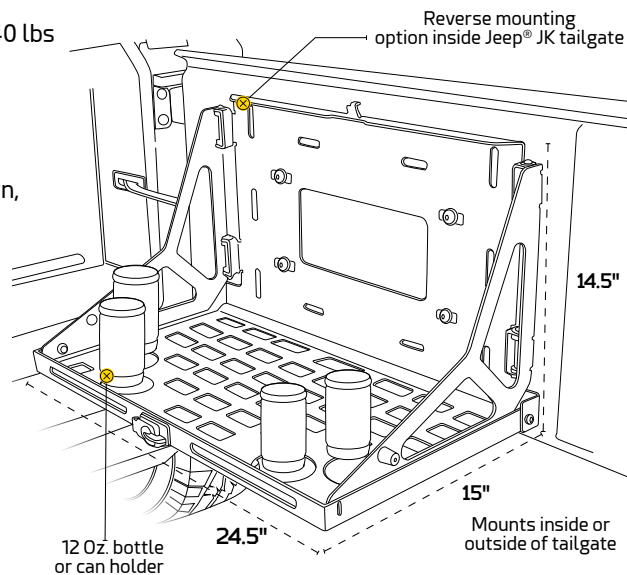

**3 STAGE TREATMENT**  
 • Dual stage powdercoating  
 • Special "E-Coat" inside & out  
 • Acid dipped to remove impurities

**LIFETIME STRUCTURAL 5 YEAR FINISH WARRANTY**

**TEXTURED TB BLACK**



# ACCESSORIES / TRIM JK

## TRAIL MIRRORS

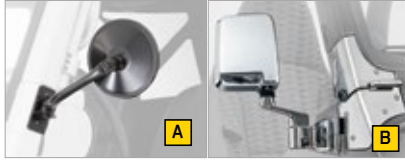

### [ A ] HINGE TRAIL MIRROR

YEAR	MODEL	PART#
07-18	Wrangler JK 2/4-DR	7618
97-06	Wrangler TJ	

### [ B ] HALF DOOR SIDE MIRRORS

YEAR	MODEL	PART#
87-06	Wrangler YJ, TJ Chrome	7504
87-06	Wrangler YJ, TJ Black	7694

- Replaces factory soft top retaining channel on half doors, fits all factory steel half doors



### [ C ] CJ SIDE MIRRORS

YEAR	MODEL	PART#
55-86	CJ St Steel (Pair)	7417
55-86	CJ Black (Pair)	7617

- Replacement for Wrangler side mirrors
- Direct bolt-on replacement  
(Drilling is required for 1987 vehicles, or vehicles that don't have passenger side mirrors)



## BILLET GRILLE

- Upgrade your vehicle with style and go with a Smittybilt billet grille!
- All our billet grilles are manufactured out of aircraft grade aluminum and then powder coated to satin black
- Easy Install! No drilling or modification required
- Kit includes separate billet inserts and all the necessary hardware

### BILLET GRILLE

YEAR	MODEL	PART#
07-18	Wrangler JK 2/4-DR	878132

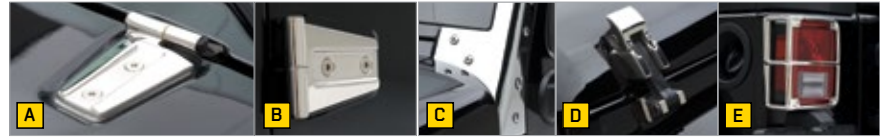

The new line of stainless steel accessories for the 2007-16 Wrangler has been completely redesigned to offer you the highest quality parts available. Each part starts off as chunk of solid 304 marine grade stainless steel. It's then cast in a pretreated mold which provides a part guaranteed to meet OEM Specifications every time. Once the casting is complete each part goes through an electrostatic polishing process that creates a high quality mirror finish. When you want a quality part that will fit and is built to last look to Smittybilt!

### [ A ] HOOD LATCH

YEAR	MODEL	PART#
07-18	Wrangler JK 2/4-DR SS	74335

- Sold in pairs

### [ B ] DOOR HINGE

YEAR	MODEL	PART#
07-18	Wrangler JK 2/4-DR SS	7487
07-18	Wrangler JK 2/4-DR BLK	7687

- Available for the front and rear doors
- Kit includes hinges, brackets and stainless steel fasteners  
(\*Front /rear uses same part#)

### [ C ] WINDSHIELD BRACKET

YEAR	MODEL	PART#
07-18	Wrangler JK 2/4-DR SS	7481
07-18	Wrangler JK 2/4-DR BLK	7681

## ADJUSTABLE DOOR STRAPS



- Helps keep any door manageable
- Easy install and adjustment lets you open door to desired position
- Sold in pairs

DESCRIPTION	PART#
Adjustable Door Strap	769401

- Formed to exact specification
- Kit includes stainless steel hardware
- Sold in pairs

### [ D ] HOOD HINGE

YEAR	MODEL	PART#
07-18	Wrangler JK 2/4-DR SS	7480
07-18	Wrangler JK 2/4-DR BLK	7680

- Kit includes a pair of hood hinges, footman loop and collars for the rubber windshield stop

### [ E ] TAIL LIGHT GUARD

YEAR	MODEL	PART#
07-18	Wrangler JK 2/4-DR SS	8465
07-18	Wrangler JK 2/4-DR BLK	8665



## DUAL BATTERY TRAY

- Increase battery capacity x 2
- Full metal construction for rugged use
- Powdercoated, corrosion resistant
- All hardware included to install batteries
- Easy install, no drilling
- Can be used with Optima batteries only

YEAR	MODEL	PART#
97-06	Wrangler TJ	2800
07-11	Wrangler JK	2799

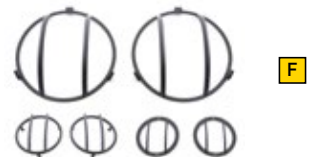

### [ F ] EURO HEADLIGHT COVERS

YEAR	MODEL			PART#
07-18	Wrangler JK 2/4-DR	2-Piece Headlight Covers	Black	5680
07-18	Wrangler JK 2/4-DR	2-Piece Front Signal Covers	Black	5690
07-18	Wrangler JK 2/4-DR	2-Piece Side Marker Guards	Black	5691
07-18	Wrangler JK 2/4-DR	6-Piece Light Guard Set (Side markers included)	Black	5692



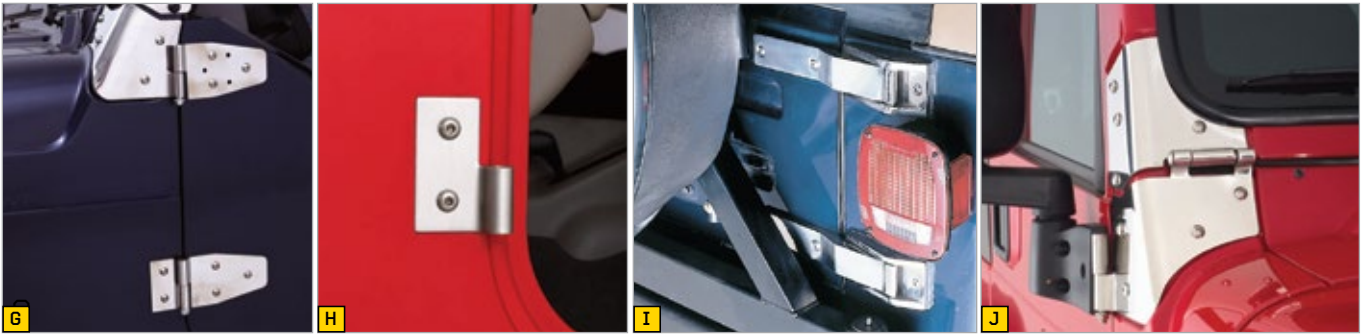

[ G ] DOOR HINGES			
YEAR	MODEL		PART#
76-93	Wrangler CJ, YJ w/ full Steel Doors	Full Steel Doors (Stainless)	7420
87-06	Wrangler TJ, LJ, YJ w/ half Steel Doors	Half Steel Doors (Stainless)	7441
00-06	Wrangler TJ, LJ w/ full Doors	Full Steel Doors (Stainless)	7441
87-06	Wrangler TJ, LJ, YJ Half Doors	Half Steel Doors (Stainless)	7641

- Complete set of 4 • No drilling required • Sold in pairs
- Also fits 87-95 Wrangler when the original windshield hinges are replaced with stainless or with black hinges, #7603 or stainless hinges, #7403

[ H ] LOWER DOOR HINGE BRACKETS			
YEAR	MODEL		PART#
76-06	Wrangler TJ, YJ, CJ	Lower Door Hinges (Stainless)	7407
76-06	Wrangler TJ, YJ, CJ	Lower Door Hinges (Black)	7607

[ I ] REAR TAIL GATE HINGES			
YEAR	MODEL		PART#
76-85	Wrangler CJ7	Rear Tail Gate Hinges (Stainless)	7419
87-95	Wrangler YJ	Rear Tail Gate Hinges (Stainless)	7442

- Mounts to existing holes • Stainless steel
- Sold in pairs • All hardware included



[ K ] HOOD CATCH KITS			
YEAR	MODEL		PART#
42-95	Wrangler CJ5, CJ7, YJ	Stainless Steel	7401
42-95	Wrangler CJ5, CJ7, YJ	Black Hood Catch	7601
97-06	Wrangler TJ, LJ	Cast Stainless Hood Catch	74334

[ L ] LOCKING HOOD CATCH			
YEAR	MODEL		PART#
97-06	Wrangler TJ	Chrome	7591
97-06	Wrangler TJ	Black	7691

- Mounts to existing holes
- Stainless Steel
- Sold in pairs
- All hardware included
- Installs easily without drilling

[ J ] WINDSHIELD HINGES			
YEAR	MODEL		PART#
76-95	Wrangler YJ, CJ	Stainless	7403
97-06	Wrangler TJ	Stainless	7493
76-95	Wrangler YJ, CJ	Black	7603

- Sold in pairs
- Pre-drilled for easy mirror installation
- Oversized design covers paint
- Complete w/ upper door hinge mount

Mirror Relocation Bracket (TJ) PART# 8691



**COMPLETE HOOD KIT**

- Complete set for the ultimate look
- Includes set of hood hinges
- Windshield tie down kit, hood vent, footman loop, and hood catches (except 7465)

[ M ] COMPLETE HOOD KIT			
YEAR	MODEL		PART#
78-95	Wrangler CJ7, YJ	Stainless	7499
98-06	Wrangler TJ	Stainless	7465
78-95	Wrangler CJ7, YJ	Black	7699



GET THE ORIGINAL

# TRIM



### [ N ] ENTRY GUARDS

YEAR	MODEL		PART#
76-95	Wrangler CJ, YJ	Stainless	7416
97-06	Wrangler TJ, LJ	Black	7486
76-95	Wrangler CJ, YJ	Black	7616
97-06	Wrangler TJ, LJ	Stainless	7686
07-18	Wrangler JK 2/4 DR	Stainless	7488*

\* 4 piece set

- Protect your door frame from scuff marks
- No drilling required
- Stainless steel or black powdercoat
- Sold in pairs

### [ O ] HALF DOOR RETAINING CHANNEL

YEAR	MODEL		PART#
87-06	Wrangler TJ, YJ	Stainless	7497

### [ P ] INSIDE WINDSHIELD BRACKET & GRAB BAR

YEAR	MODEL		PART#
76-95	Wrangler CJ, YJ	Bracket (Pair)	7408
55-86	Wrangler CJ	Grab Bar	7409



### [ S ] WINDSHIELD TIE DOWNS

YEAR	MODEL		PART#
55-95	Wrangler CJ, YJ (Stainless)		7411



Filler housing included with Part #75007



### [ T ] BILLET STYLE GAS COVER

YEAR	MODEL		PART#
07-18	Wrangler JK 2/4-DR	Billet Style Gas Cover (Black)	75007*

- Installs on existing mounting holes over factory gas cap opening
- Includes filler housing
- Fits 2007-18 JK Wrangler, Rubicon and Unlimited, 2- and 4-door
- Light textured black
- No drilling required
- Aluminum door and trim ring



### [ Q ] BILLET STYLE GAS COVER

YEAR	MODEL		PART#
97-06	Wrangler TJ, LJ	Billet Style Gas Cover (Polished)	75000
97-06	Wrangler TJ, LJ	Billet Style Gas Cover (Black)	75006

- Manufactured of polished aluminum, then specially treated for durability and shine - Resistant to gasoline and other hazardous chemicals
- Installs over the top of your factory gas cap/opening to existing mounting holes – no drilling required (uses your existing gas cap)
- Available in polished aluminum with a clear coat or powdercoat painted black billet aluminum finishes

\* Note: Light textured finish



### [ R ] GAS FILTER HOUSING

YEAR	MODEL		PART#
97-06	Wrangler TJ, LJ	Gas Filter Housing (Chrome)	7508

- Add a dash of class to your new Jeep
- Direct replacement, no drilling required





**[ T ] GRILLE INSERTS**

YEAR	MODEL		PART#
97-06	Wrangler TJ	Billet Aluminum, w/ trim	75511
97-06	Wrangler TJ	Billet Aluminum, no trim	869000
97-06	Wrangler TJ	Chrome Insert w/ trim	7511
87-95	Wrangler YJ	Chrome Insert w/ trim	7509
07-18	Wrangler JK	Bolt over	878132

- Billet inserts are machined from billet aluminum and polished to a high luster
- Chrome inserts add great styling and appearance
- Durable and corrosion resistant
- Easy to install - no drilling

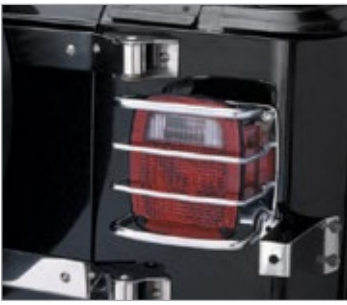

**[ U ] EURO HEADLIGHT COVERS**

YEAR	MODEL		PART#
97-06	Wrangler TJ	2-Piece Headlight Covers S/S	5460
97-06	Wrangler TJ	4-Piece Turn Signal Covers** S/S	5470
87-95	Wrangler YJ	4-Piece Headlight Covers BLK	5659
97-06	Wrangler TJ	2-Piece Headlight Covers BLK	5660
97-06	Wrangler TJ	4-Piece Turn Signal Covers**BLK	5670

- \*\* Side markers included
- Durable design protects your headlights and turn signal lights from impact damage
  - Prime 304 stainless steel polished to a mirror finish – Guaranteed not to rust
  - Dramatic powdercoat black Euro-styling for a clean look
  - Easy to install — No drilling required
  - Protect those expensive rear tail light with these new stainless steel or black powdercoated steel tail light Euroguards
  - Bolt on between the tail light and body with no drilling required



**[ V ] REAR TAIL LIGHT EURO GUARDS**

YEAR	MODEL		PART#
76-06	Wrangler TJ, YJ, CJ7	Black	8660
76-06	Wrangler TJ, YJ, CJ7	SS	8460





**SMITTYBILT**

GET THE ORIGINAL

# RECOVERY & WINCHES UNIVERSAL TRAIL EQUIPMENT

PICTURED: OVERLANDER TENT AND AWNING MOUNTED ON SCOUT TRAILER KIT (SEE NEXT PAGE)





### WINCHES

More pulling power and increased speed are hallmarks of Smittybilt winches.

Page 118



### RECOVERY

Straps, hooks, winch mounts, fairleads, bags, shackles, and much more.

Page 130



### REPAIR

Quick and easy repairs on the trail are essential to any on or off-roader.

Page 132



### AIR COMPRESSORS

Don't let a flat deflate your weekend - be prepared to for anything.

Page 133



### OVERLANDER

Nothing is better than a backcountry camping trip with the family.

Page 108



### SOFT GEAR

Smittybilt offers ingenious ways to cover, pack and store everything for the Jeep.

Page 114



### TOOLS

Smittybilt has you covered with all your tools for the trail.

Page 115



### TOWING

Haul your toys to any destination with Smittybilt's towing accessories.

Page 136





# SCOUT TRAILER KIT



## Get Off-Grid with the new Smittybilt SCOUT Trailer Kit

Spend less time packing and more time overlanding.



Complete base camp that sets up in minutes



Sliding drawers for generator and fridge/freezer (accessories sold separately)



2" front receiver accepts multi-axis articulation couplers



Full suspension and brake system with the ability to handle the toughest terrain



Sliding drawers for generator and fridge/freezer (accessories sold separately)



Compatible with Smittybilt Tents and Awnings (accessories sold separately)



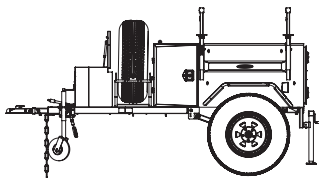
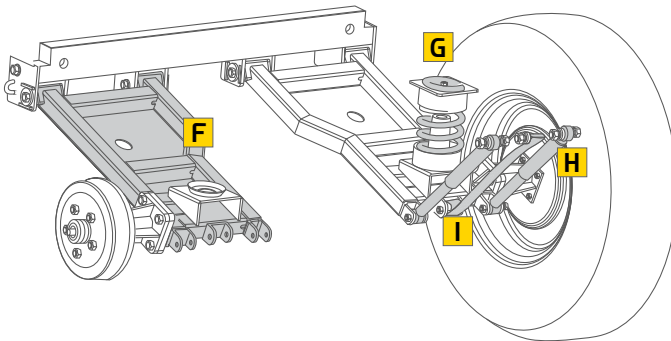
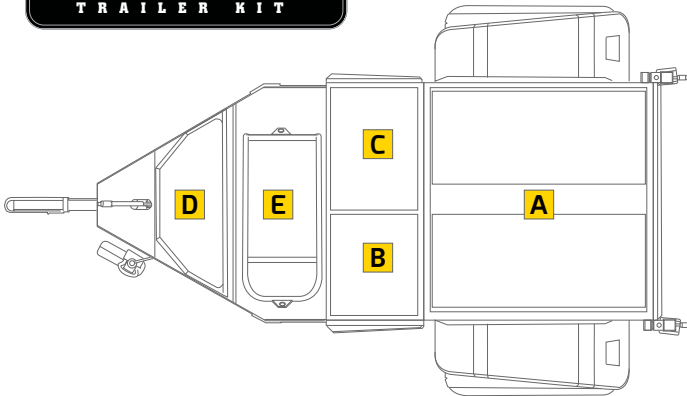

87400 Scout Trailer Kit

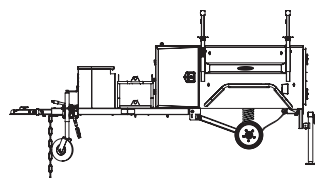

87400-01 Scout Trailer Kit – trailer only

TRAILER SPECS			
Overall size	75"(w) x 54"(h) x 120"(l)		
Box size	48"(w) x 27.5"(h) x 67"(l)		
Main compartment	48"(w) x 47"(h)		
Bed interior	59.5" x 89"	Payload cap.	1763 lbs
Deck height	33"	Dry curb wt.	1543 lbs
Axle clearance	15.5"	GVWR	3306 lbs
Track width	63.4"	Turning radius	11'
Distance bet. wheel wells - 48"			
WHEEL AND TIRES (87400 ONLY)			
Tires	265/70R17 A/T Sport Tires (pair)		
Wheels	17" x 9" Pro Comp Steel (pair)		
Bolt Pattern	5 x 5		

DESCRIPTION	PART#
SCOUT Trailer Kit, Complete w/ Wheels and Tires	87400
SCOUT Trailer Kit, trailer only	87400-01

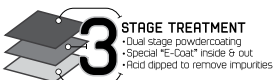

## A MAIN COMPARTMENT

- Dual locking T-handle door and water resistant seals
- Dual locking sliding drawers with secondary spring-loaded locking mechanism
- Hardened steel sliders with 200 lb. capacity
- Footman loops for drawer cargo securement
- Eight eyebolt hooks on interior side panels for extra cargo securement
- Drawer 1:  
Flat surface drawer ideal for large, rigid objects
- Drawer 2:  
Recessed drawer ideal for sleeping bags and/or tools

## B KITCHENETTE COMPARTMENT

- Locking T-handle door and drawer with water resistant seals
- Top Compartment Bin: 4.4 Cubic feet of storage
- Bottom Compartment Drawer: Hardened steel sliders with 100 lb. capacity; Adjustable height stainless steel stabilizer legs

## C GENERATOR COMPARTMENT

- Locking T-handle door with water resistant seals
- Locking bucket drawer with height-adjustable stainless steel stabilizer legs
- Vented drawer with maximized air flow ideal for a generator
- Hardened steel sliders with 100 lb. capacity

## D TONGUE BOX

- Lockable T-handle and water resistant door seals
- Ideal for towing accessory storage

## E SPARE TIRE MOUNT

- Universal spare tire mount fits up 37" x 12.50" tire
- Dual ratcheting tire straps
- Multiple tie-down configurations
- Removable

## F INDEPENDENT TRAILING A-ARMS

- Strong construction to withstand random hits from rocks, roots, and plain old dirt. Articulates for maximum ground clearance

## G COMFORT RIDE COIL SPRINGS

- Helical Axis design for a smooth ride

## H DUAL SHOCK ABSORBERS

- Reduces the effect of traveling over rough terrain with spring-loaded check valves that control the flow of oil through an internal piston

## I LIMIT STRAPS

- Heavy duty dual-layered nylon-sewn webbing designed to prevent trailing a-arm over extension and avoiding suspension damage



GET THE ORIGINAL

## OVERLANDER TENT AND ANNEX



Shown: Standard size Overlander tent with protective rain fly

### OVERLANDER ROOF TOP TENT AND ANNEX

Few things are more rewarding than camping in the backcountry and roof top tents are a great way to set up camp in a hurry. Smittybilt's Overlander Tent is packed full of features and sets up in just minutes, keeping you safe and secure as you sleep. An optional Annex can be added to the bottom of the deployed tent with rugged zippers. Both the tent and annex are constructed from 600D heavy duty ripstop polyester that has been impregnated with polyurethane to ensure they are completely waterproof. Available in Standard (sleeps 2-3) or XL (sleeps 3-4) sizes.

#### OVERLANDER TENT

- Comes in two sizes: Standard (sleeps 2-3, 661 lb. max load) and XL (sleeps 3-4, 770 lb. max load)
- 60 mm high-density foam mattress with removable cover
- Easy to set up and take down, packable in heavy duty PVC cover keeps the tent completely dry and free from UV rays
- Includes sunroof, side windows with mosquito netting, heavy duty rain fly, Interior LED strips, shoe storage bag, anodized aluminum tent frame poles with stainless steel hinges

#### OVERLANDER ANNEX

- Provides extra privacy room for cooking, changing clothes, sleeping or more
- Attaches to tent with rugged, heavy duty zippers
- Comes in two sizes: Standard (70" x 80" floor, 10 ground stakes) and XL (82" x 93" floor, 12 ground stakes)
- Heavy duty, zippered removable floor keeps out mud and bugs
- Inner door flap allows easy access to your vehicle
- Side door and windows roll up for full access with underlying mosquito netting which can be opened or closed

*PLEASE NOTE: \*XL tent is for trailer use only and not compatible with SRC cage kits. Illustration on this spread shown only to show relative size between Standard and XL Tent. See full specs in chart on the right.*



# OVERLANDER TENT AND ANNEX



Standard Tent: 95"(W) x 56"(L)

XL Tent: 122"(W) x 76"(L), Sleeps 3-4



OVERLANDER TENT & ANNEX		
DESCRIPTION	PART#	
<b>A</b> Overlander Tent	2783	
<b>B</b> Overlander Tent - XL*	2883	
<b>C</b> Tent Ladder Extension	2785	
<b>D</b> Tent Annex	2788	
<b>E</b> Tent Annex - XL (Not Shown)	2888	

SPECS	REG. TENT (2783)	XL TENT (2883)
<b>Sleeps</b>	<b>2-3 (Double/Full Bed)</b>	<b>3-4 (King Bed)</b>
Open size	95"W x 56"L x 51"H	122"W x 76"L x 51"H
Closed size	47"W x 55"L x 11.5"H	47"W x 76"L x 11"H
Packing size	58" x 49" x 13"	78" x 49" x 12"
Gross Weight	132 lbs / 59.8 kgs	148 lbs / 67 kgs
New Weight	116.5 lbs / 52.8 kgs	139 lbs / 63 kgs
Load capacity	661 lbs / 300 kgs	770 lbs / 350 kgs
Ladder	Anodized aluminum ladder extends up to 6.5' / 2m (opt. ladder extension available)	Anodized aluminum ladder extends up to 6.5' / 2m (opt. ladder extension available)
Ladder cap.	265 lbs / 120 kgs.	
Mattress size	92" x 55" (Full)	92.5" x 74.8" (King)
Water column	1500mm	2000mm
Travel bag	Heavy-duty 600gsm, 500d PVC cover. Zips for complete waterproofing. UV-res. straps	Heavy-duty 650gsm, 1000d PVC cover. Hook and loop fastener lining for complete water-proofing. UV-res. straps
Top material	600D heavy-duty rip stop polyester, water-proof, polyurethane impregnated	600D heavy-duty rip stop polyester, water-proof, polyurethane impregnated
Base	1" aluminum/ polyurethane	1-3/16" aluminum/ polyurethane
Mattress	60mm high-density foam with removable cover	
Water column	1500mm	
Tent poles	Anodized aluminum tent frame poles and stainless steel hinges	
Rain Fly	Lightweight, waterproof 420D oxford flysheet 4mm spring steel durable flysheet poles	
Also includes	Interior LED strip, mosquito net, CE approved cigarette lighter adapter, Shoe storage bag	
Warranty	One Year	
ANNEX	REG. ANNEX (2788)	XL ANNEX (2888)
Warranty	One Year	One Year
Floor size	70" x 80"	82" x 93"
Material	600D heavy-duty rip stop polyester, waterproof, polyurethane impregnated	600D heavy-duty rip stop polyester, waterproof, polyurethane impregnated
Also includes	10 adjustable tension tie down points with 10 ground stakes.	12 adjustable tension tie down points with 12 ground stakes

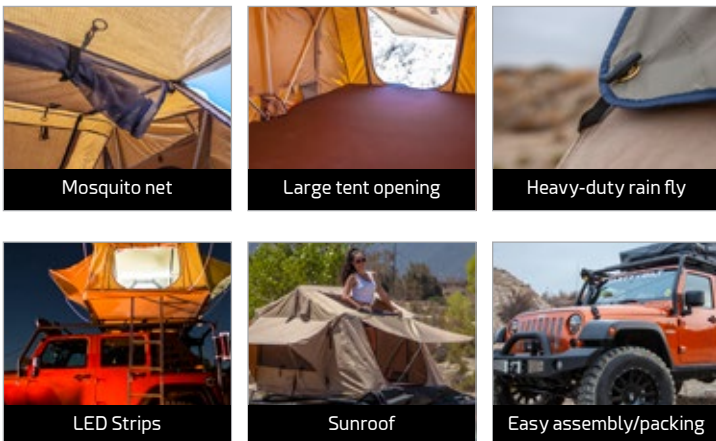



GET THE ORIGINAL

## OVERLANDER AWNING / SHADE



Tent Awning closed



DESCRIPTION	PART#
Awning - 6.5'	2787
Awning - 8.2'	2784

AWNING SPECS	
Warranty	One Year
Open size	6.5' x 6.5' or 8.2' x 6.5'
Material	280g polyester cotton (T/C), PU 2000mm waterproof and water resistant. Heavy duty UV-stabilized cover, 650gsm, 1000 PVC with Hook and loop fastener
Travel bag	Heavy duty 1000D PVC for waterproofing. Features UV-resistant straps and strong, long lasting Hook and loop fastener attachment points.
Legs and rails	Lightweight extruded aluminum, self-contained telescopic legs/arms and twist-lock poles
Also includes	Includes stakes and ropes for securing legs in harsh conditions
Color	Coyote Tan

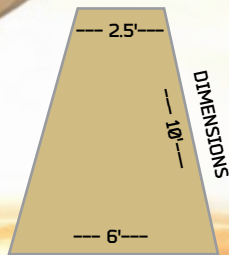

### TRAIL SHADE

- Lightweight tent material
- Fully extended, canopy is 2.5' at base, 10' long and 6' at its widest point
- Durable, lightweight backpack style bag included
- Can be mounted on a tire up to 37"
- Includes 10-foot canopy, stakes, poles and cords
- Easily collapsible pole sleeves
- Sets up in seconds, attaches to just about anything

DESCRIPTION	PART#
Trail Shade	5662424







**2600W EPS**  
ESSENTIAL POWER SOURCE  
**DIGITAL INVERTER / GENERATOR**

Remote Start!

**EPS INVERTER GENERATOR**

Embrace the clean power of Smittybilt's new E.P.S. Inverter Generator. The latest technology has allowed Smittybilt to pack huge power into a small and quiet package. The "Smart Throttle" allows the motor to run at varying speeds for maximum fuel efficiency – something conventional generators cannot match. The Inverter's "3-phase inversion process" produces clean power allowing direct plug-in of sensitive electronics without worry. Count on Smittybilt to keep the power flowing.

- 2600w max output, 2300w continuous
- Years of service – Inverter has no moving parts
- C.A.R.B.-approved 4-stroke, OHV gas engine
- Low noise, 56~63 dB, 58 dB at 7M
- Dual 120 VAC outlets, Single 12VDC outlet
- 6-hour duty cycle at 50% load, with overload protection
- 1.5-gallon fuel tank
- One Year Warranty



Link Cable Included



DESCRIPTION	PART#
EPS Inverter Generator	2786



Ideal for overland adventures, camping, motorhomes, trailers, and marine use

**52**  
QUART

Perfect for tropical or desert climates – the Arctic can freeze products even in blistering hot temperatures!

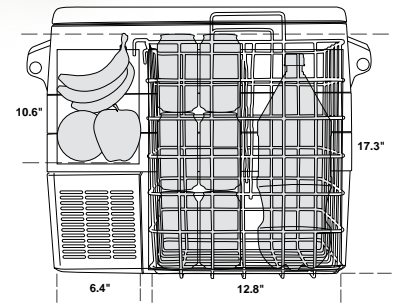

**ARCTIC FRIDGE/FREEZER**

- Fast cool capability
- Anti-vibration design for harsh conditions
- No heat radiation and low power consumption
- Recessed digital control panel for streamlined design
- Adjustable temperature from an ice cold -22°F and up to 50°F
- Automatic on/off internal LED lighting
- 3-stage automatic power cut off to protect the battery
- Fruit and dairy compartment with automatic interior LED light
- Removable storage basket and separate dairy section
- Large storage capacity with aluminum-lined interior
- Lightweight design for multiple mounting options
- Latest ultra-efficient German technology Danfoss compressor
- AC/DC multi-voltage power supply
- Overall Dimensions: 22" L x 13.5" W x 21" H
- One Year Warranty

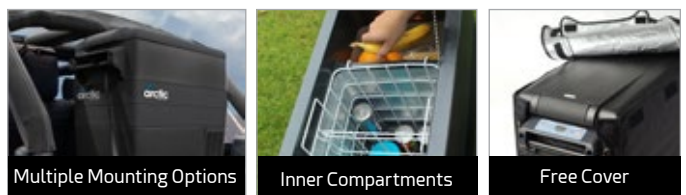
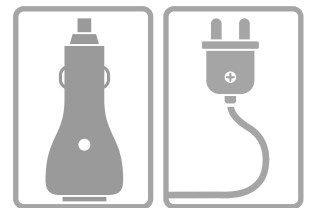

DESCRIPTION	PART#
Arctic Fridge/Freezer	2789



GET THE ORIGINAL

## SOFT GEAR / STORAGE

### TRAIL BAG

Smittybilt has just developed the only Trail Bag you'll ever need. When it's positioned in the back of your Jeep, you can use the integrated tie down points to make sure it is secured. When it's time to remove the bag, there are backpack straps and roller wheels for your convenience.

- Heavy-duty 600 denier ballistic nylon
- Three quick-access outer compartments
- Adjustable padded shoulder strap
- Converts to backpack w/integrated straps
- Easy-go roller wheels
- MOLLE/PALS webbing for extra pouches
- Tie down straps to vehicle anchor points
- Hideaway rain cover



DESCRIPTION	PART#
Trail Bag	2826

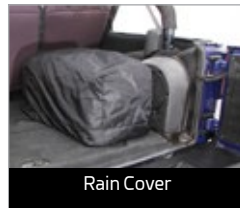

Rain Cover



Converts to Backpack



### PICK IT UP MESH BAG

- Simple way to carry trash off the trail
- Straps easily to roll bar or back tire
- Backpack-style allows various usage
- Made of heavy-duty nylon mesh that is durable enough to last a lifetime

DESCRIPTION	PART#
Pick-It-Up Mesh Bag	2792

### FIRST AID KIT BAG

- Multiple individual pouches to store your first aid essentials
- Attaches to your roll bar with Hook and loop fastener straps
- Easy access when carried on the trail or during emergencies
- Bag only - contents not included



DESCRIPTION	PART#
First Aid Kit Bag	769541

### .50 AMMO CAN WITH BAG

This solid steel, unissued military grade .50cal M2A1 ammunition can has been manufactured to US Department of Defense specs. The solid steel construction and waterproof seal will keep the contents dry and safe and dry. It comes with a durable carrying bag with adjustable shoulder strap to make transporting it a breeze. The ammo can and bag can be used together or independently.

- Removable lid with rubber gasket for watertight seal
- Durable semi-gloss black powdercoat
- Can external: 12" x 7 1/2" x 6 1/8"
- Can internal: 11" x 6 3/4" x 5 1/2"
- Weight: 5.7 lbs.
- Can Thickness: 0.8mm
- Airtight and watertight – IP64 Waterproof Rating
- Optional Smittybilt decals
- 600D ballistic nylon carrybag with removable/adjustable 55" strap
- Bag features five exterior pouches

DESCRIPTION	PART#
Ammo Can with Bag	2827



Semi-Gloss Black Powdercoat



Adjustable Shoulder Strap



Five Exterior Pouches





**TRAIL AXE**

- 402 stainless heat treated blade
- 4" x 7.5" axe head with protective sheath
- Upswept for improved chopping efficiency
- Nylon reinforced ergonomic handle
- D-ring slot to tighten and loosen pin
- 19mm hex to aid in loosening bolts and nuts
- Handy tube located inside handle contains Survival Kit: compass, fishing line, sewing needle, flint stick and strong nylon

DESCRIPTION	PART#
<b>A</b> Trail Axe	2828

**MACHETE**

- Composite plastic TPR non-slip handle
- Blade finished in electric black oxide
- 19" overall length, 13.75" blade length, 1/8" thick blade
- Razor sharp 420 stainless steel
- Carrying case with roll bar straps included

DESCRIPTION	PART#
<b>D</b> Machete	2833

**T.R.U. (TASK READY UTILITY) KNIFE**

- Composite plastic TPR non-slip handle
- Blade finished in electric black oxide
- Built-in wire cutter
- 13" overall length, 7.75" blade, 1/8" thick blade
- Composite plastic TPR sheath
- Razor sharp 420 stainless steel
- Sharpening stone included
- Carrying case with roll bar straps included

DESCRIPTION	PART#
<b>B</b> T.R.U. Knife	2832

**A.C.T. COMPACT TOOL**

- 10-in-1 multi compact tool: knife, ruler, saw, screwdrivers (Philips and flat head), bottle opener, wire cutter, pliers, can opener and file
- Spring loaded plier jaws
- Aluminum comfort grip
- 3CR13 heat treated steel blade
- Ballistic nylon carrying case included

DESCRIPTION	PART#
<b>E</b> A.C.T. Compact Tool	2829

**T.A.S.C. ALL-PURPOSE COMBO KNIFE**

- Composite plastic TPR non-slip handle
- Safe cutting
- Tanto point blade profile
- Full tang for maximize strength
- Integrated windshield spike in handle
- Electric black titanium oxide finished blade
- Carrying case with roll bar straps

DESCRIPTION	PART#
<b>C</b> T.A.S.C. Knife	2831

**BUGOUT SAW**

- Perfect for everyday outdoor use
- 7" blade
- 14-5/8" open, 8-1/2" closed
- Non-slip ergonomic handle for secure grip and performance
- 65M blade, 18 gauge, 8TPI teeth space and hardened to 58 HRC
- Durable black anti-rust e-coating for long life
- 600D denier pouch for safe keeping

DESCRIPTION	PART#
<b>F</b> Bugout Saw	2835



**SMITTYBILT**

GET THE ORIGINAL

**SMITTYBILT**

**SMITTYBILT**





## GEN2 WATERPROOF WINCHES

The new generation of Smittybilt XRC and X20 winches have been enhanced in almost every area for increased performance and trouble free operation. If you're looking for something more versatile, check out the COMP series, complete with all the features and benefits of the original series, except equipped with a synthetic rope.

What kind of improvements have been made?

Comparison chart below shows 9,500/10,000lb specs of a competitor's winch, Smittybilt's previous line of winches and the new and improved Smittybilt Gen2 XRC winch.

	Competitor's winch 9500 lbs	Smittybilt XRC 10 10000 lbs	<b>XRC GEN2 WATERPROOF WINCH 9500 LBS</b>	
<b>Warranty</b>	Ltd Lifetime / 1 year	Ltd Lifetime / 1 year	<b>Lifetime Mechanical 3-Year Electrical</b>	› <b>Extended Warranty for greater peace of mind</b>
<b>Waterproof Rating</b>	N/A	N/A	<b>IP67</b>	› <b>International Standard waterproof rating</b>
<b>Gear Reduction</b>	212 : 1	218 : 1	<b>161 : 28</b>	› <b>More power allows higher ratio/faster line speed</b>
<b>Cable Diameter</b>	.375"	0.359"	<b>0.313"</b>	› <b>Correctly designed cable saves weight</b>
<b>Line Speed fpm @ 8000 lbs**</b>	8.6	7.38	<b>9.4</b>	› <b>Faster line speeds = less time winching + more time wheeling!</b>
<b>Motor Draw @ 8000 lbs**</b>	300 Amps	425 Amps	<b>435 Amps</b>	› <b>37% more horsepower</b>
<b>Motor</b>	4.8 HP	5.5 HP	<b>6.6 HP</b>	› <b>More horsepower = More pulling power</b>
<b>Weight</b>	95 lbs	94 lbs	<b>78 lbs</b>	› <b>Less weight means less drag on the front end</b>

## WHICH GEN2 WINCH DO I NEED?

Comparison chart below shows the features of the entire line of new Gen2 Waterproof winches.



	<b>X20</b>	<b>X20 COMP</b>	<b>XRC</b>	<b>XRC COMP</b>
<b>Powerful 6.6 HP Motor</b>	✓	✓	✓	✓
<b>3-Stage Planetary Gear System</b>	✓	✓	✓	✓
<b>Upgraded Pulling Power*</b>	✓	✓	✓	✓
<b>Upgraded Line Speed*</b>	✓	✓	✓	✓
<b>Larger Clutch Lever*</b>	✓	✓	✓	✓
<b>Stainless Steel Hardware</b>	✓	✓	✓	✓
<b>Oversized Aluminum Crossbar</b>	✓	✓	✓	✓
<b>Wireless Remote Control</b>	✓	✓		
<b>Dynamic Braking System</b>	✓	✓		
<b>Fairlead</b>	4-Way Roller	Competition Aluminum	4-Way Roller	Competition Aluminum
<b>Cable/Rope Type</b>	Steel Cable	Synthetic Rope	Steel Cable	Synthetic Rope
<b>Solenoid Mounting Options</b>	2	2	3	3
<b>Waterproof Rating</b>	IP68	IP68	IP67	IP67
<b>Mechanical Warranty</b>	Lifetime Warranty	Lifetime Warranty	Lifetime Warranty	Lifetime Warranty
<b>Electrical Warranty</b>	5-Year Warranty	5-Year Warranty	3-Year Warranty	3-Year Warranty
<b>Sizes/Part Numbers</b>	10k lbs. #97510	10k lbs. #98510	9.5k lbs. #97495	9.5k lbs. #98495
	12k lbs. #97512	12k lbs. #98512	12k lbs. #97412	12k lbs. #98412
	15.5k lbs. #97515	15.5k lbs. N/A	15.5k lbs. #97415	15.5k lbs. N/A
	17.5k lbs. #97517	17.5k lbs. N/A	17.5k lbs. #97417	17.5k lbs. N/A

\*Compared to classic Smittybilt winches

**SMITTYBILT**

GET THE ORIGINAL

## GEN2 X20 WINCHES

# X20 WINCH



UV-resistant matte black textured finish

Remote Plug Cover

Powerful amphibious 6.6 HP motor – highest torque in the industry

Oversized tie rod struts for maximum strength

Steel or synthetic rope geared for fast line speed

Inductive braking system reduces heat for long lasting performance

Larger clutch for control during gloved operations

**WIRELESS**

Integrated Wireless Remote Control (X20)



Competition Aluminum Fairlead (COMP Series)

Forged Hook

Rear Wire Isolator (not pictured)

Rope Sleeve (COMP Series)

Pictured: #98512

## X20 GEN2 WIRELESS WATERPROOF WINCH

The new generation of Smittybilt X20 winches have been enhanced in almost every area for increased performance and trouble free operation. Each X20 winch features a series wound amphibious 6.6 HP motor which is completely sealed, as well as a 3-stage planetary gear system. They have a completely waterproof, state-of-the-art 500AMP solenoid that has the versatility to be mounted in two different locations depending on your application needs. They also include a new controller that can be wired directly to the winch or unplugged for trouble free wireless operation. If you're looking for something more versatile, check out the X20 COMP series, complete with all the features and benefits of the original series, except equipped with a synthetic rope. The performance of the new X20 series cannot be beat. With gear ratios delivering lightning fast speed, coupled with Smittybilt's lifetime warranty, you can count on the X20 winch to be there every time, in every situation.



Multiple mounting options on the control pack

### EXCLUSIVE FEATURE OF THE X20 SERIES: DYNAMIC INDUCTIVE BRAKING SYSTEM

- Synthetic rope approved
- 66% less heat generated than traditional dynamic brake drums

	Ambient Temp.	Initial of Drum	Work Cycle	Final Temp.	Rise in Drum Temp.
X20 GEN2 WINCH	86°F	86°F	10 min	<b>90°F</b>	<b>+ 4°F</b>
Competitor	86°F	86°F	10 min	158°F	+ 72°F





## 10,000 LB. WIRELESS WINCH

Waterproof:	IP68 rating
Rated Line Pull:	10000Lbs (4535kgs) single-line
Motor:	6.6Hp series wound
Control:	Remote switch, 12' (3.7M) lead
Gear Train:	3-Stage Planetary
Gear Ratio:	218:1
Clutch:	Sliding ring gear
Brake:	Automatic out-of-drum
Drum Size:	Diameter 2.5" (63.5mm)
Length:	10.0" (254mm)
Fairlead:	4-way roller (COMP series: aluminum fairlead)
Remote Control:	Included. Wireless or wired options
Rec. Battery:	650CCA minimum for winching
Battery Leads:	25mm <sup>2</sup> , 72"(1.83m)1
Finish:	Textured black
Weight:	99.0Lbs (45.0Kgs)
Mounting Bolt Pattern:	10.0" x 4.50"
Overall Dimensions	(L x W x H) 22.3" x 5.4" x 9.4"
Cable:	98.5' 3/8" Diameter

DESCRIPTION	PART#
X20 10,000 LBS WINCH SYSTEM	97510
X20 10,000 LBS WINCH COMP	98510

## X20 WINCH FEATURES



Waterproof. Wireless Remote w/Wired Option.



Steel Cable



4-Way Roller Fairlead

## LINE SPEED / AMP DRAW (FIRST LAYER)

Line Pull	lbs	No Load	2000	4000	6000	8000	10000
	kg	No Load	907	1814	2721	3628	4545
Line Speed	ft/min	31.1	14.3	11.7	10.17	8.8	7.38
	m/min	9.5	4.3	3.5	3.2	2.7	2.25
Motor	Amps	76	150	220	270	320	380

## 10,000LBS LINE PULL AND CABLE CAPACITY

Layers of cable		1	2	3	4
Rated line pull	lbs	10000	9100	8570	7950
Per layer	kg	4545	3915	3499	3215
Cumulative cable	ft	19.6	44.2	73.8	98.4
Capacity	m	6	13	22	30

## THE COMP SERIES DIFFERENCE



Competition Aluminum Fairlead



Synthetic Winch Rope (94 ft)

- High-grade billet aluminum material
- Reduces binding and friction caused by angled pulls and protects your synthetic rope from excessive wear
- Will not fray or tangle synthetic rope
- Standard bolt pattern

- 1/7th the weight of steel cable
- Minimal stretch, non-rotational, no kinks, curls or wire splinters
- UV and abrasion resistant
- Specially coated to prevent slippage
- Protective sleeve prevents overheating

**SMITTYBILT**

GET THE ORIGINAL

# GEN2 X20 WINCHES



## 12,000 LB. WIRELESS WINCH

Waterproof:	IP68 Rating
Rated Line Pull:	12,000Lbs (5,454kgs) single-line
Motor:	6.6hp Series Wound
Control:	Remote Switch, 12' (3.7m) lead
Gear Train:	3-Stage Planetary
Gear Ratio:	265:1
Clutch:	Sliding Ring Gear
Brake:	Automatic Out-Of-Drum
Drum Size:	Diameter 2.5"
Length:	10.0" (254mm)
Fairlead:	4-way roller (COMP series: aluminum fairlead)
Remote Control:	Included. Wireless or wired options
Rec. Battery:	650CCA Minimum for Winching
Battery Leads:	25mm <sup>2</sup> , 72"(1.83m) <sup>1</sup>
Finish:	Textured Black
Weight:	99.0Lbs (45.0Kgs)
Mounting Bolt Pattern:	10.0" x 4.50"
Overall Dimensions	L x W x H) 22.3" x 5.4" x 9.4"
Cable:	98.5' 3/8" Diameter

DESCRIPTION	PART#
X20 12,000 LBS WINCH SYSTEM	97512
X20 12,000 LBS WINCH COMP	98512

## X20 WINCH FEATURES



Waterproof. Wireless Remote w/Wired Option.



Steel Cable



4- Way Roller Fairlead

## LINE SPEED / AMP DRAW (FIRST LAYER)

Line Pull	lbs	No Load	3000	6000	9000	12000
	kg	No Load	1363	2727	4090	5454
Line Speed	ft/min	24.60	11.48	8.86	7.22	5.58
	m/min	7.5	3.5	2.7	2.2	1.7
Motor	Amps	70	138	218	260	330

## 12,000LBS LINE PULL AND CABLE CAPACITY

Layers of cable		1	2	3	4
Rated line pull	lbs	12000	9530	7929	6770
Per layer	kg	5455	4332	3604	3077
Cumulative cable	ft	18	37	64	98
Capacity	m	5.4	11.4	19.4	30

## THE COMP SERIES DIFFERENCE



Competition Aluminum Fairlead



Synthetic Winch Rope (94 ft)

- High-grade billet aluminum material
- Reduces binding and friction caused by angled pulls and protects your synthetic rope from excessive wear
- Will not fray or tangle synthetic rope
- Standard bolt pattern

- 1/7th the weight of steel cable
- Minimal stretch, non-rotational, no kinks, curls or wire splinters
- UV and abrasion resistant
- Specially coated to prevent slippage
- Protective sleeve prevents overheating





97515



## 15,500 LB. WIRELESS WINCH

DESCRIPTION	PART#
X20 15,500 LBS WINCH SYSTEM	97515

Waterproof:	IP68 Rating
Rated Line Pull:	15,500Lbs (7,045kgs) single-line
Motor:	6.6hp Series Wound
Control:	Remote Switch, 12' (3.7m) lead
Gear Train:	3-Stage Planetary
Gear Ratio:	430:1
Clutch:	Sliding Ring Gear
Brake:	Automatic Out-Of-Drum
Drum Size:	Diameter 3.45"(88.0mm)
Length:	10.0" (254mm)
Fairlead:	4-Way Roller
Remote Control:	Included
Rec. Battery:	650CCA Minimum for Winching
Battery Leads:	25mm <sup>2</sup> , 72"(1.83m)1
Finish:	Textured Black
Weight:	150.0Lbs (68.0Kgs)
Mounting Bolt Pattern:	10.0" x 4.50"
Overall Dimensions	L x W x H) 22.3" x 7.5" x10.7"
Cable:	98.5' 7/16" Diameter

### LINE SPEED / AMP DRAW (FIRST LAYER)

Line Pull	lbs	No Load	4000	7500	11250	15500
	kg	No Load	1814	3409	5113	7045
Line Speed	ft/min	23.62	10.50	8.20	5.25	3.94
	m/min	7.2	3.2	2.5	1.6	1.2
Motor	Amps	71	152	239	332	422

### 15,500LBS LINE PULL AND CABLE CAPACITY

Layers of cable		1	2	3	4
Rated line pull	lbs	15500	12060	10082	8662
Per layer	kg	7045	5482	4583	3937
Cumulative cable	ft	19.68	45.92	75.44	85.28
Capacity	m	6	14	23	26



97517



## 17,500 LB. WIRELESS WINCH

DESCRIPTION	PART#
X20 17,500 LBS WINCH SYSTEM	97517

Waterproof:	IP68 Rating
Rated Line Pull:	17,500Lbs (7,954kgs) single-line
Motor:	6.6hp Series Wound
Control:	Remote Switch, 12' (3.7m) lead
Gear Train:	3-Stage Planetary
Gear Ratio:	430:1
Clutch:	Sliding Ring Gear
Brake:	Automatic Out-Of-Drum
Drum Size:	Diameter 3.45"(88.0mm)
Length:	10.0" (254mm)
Fairlead:	4-Way Roller
Remote Control:	Included
Rec. Battery:	650CCA Minimum for Winching
Battery Leads:	25mm <sup>2</sup> , 72"(1.83m)1
Finish:	Textured Black
Weight:	150.0Lbs (68.0Kgs)
Mounting Bolt Pattern:	10.0" x 4.50"
Overall Dimensions	(L x W x H) 22.3" x 7.5" x10.7"
Cable:	98.5' 7/16" Diameter

### LINE SPEED / AMP DRAW (FIRST LAYER)

Line Pull	lbs	No Load	6000	10000	12000	14000	17500
	kg	No Load	2721	4536	5454	6363	7937
Line Speed	ft/min	23.62	9.18	5.90	4.92	4.26	2.95
	m/min	7.2	2.8	1.8	1.5	1.3	0.9
Motor	Amps	71	200	300	350	395	450

### 17,500LBS LINE PULL AND CABLE CAPACITY

Layers of cable		1	2	3	4
Rated line pull	lbs	17500	15225	13246	11524
Per layer	kg	7955	6920	6021	5238
Cumulative cable	ft	19.68	45.92	75.44	85.28
Capacity	m	6	14	23	26

**SMITTYBILT**

GET THE ORIGINAL

# GEN2 XRC WINCHES

## XRC WINCH



## XRC GEN2 WATERPROOF WINCH

The new series of Smittybilt XRC winches have been thoroughly updated with heavy-duty features for enhanced performance and durability. Ranging from 9,500lb – 17,500lb, Smittybilt's XRC winches can handle any situation you get into. The new 6.6HP motor is connected to a 3-stage planetary gear system with revised gear ratios for increased pulling power and line speed. Every winch is finished in a rugged UV-resistant matte black coating with stainless steel hardware and oversized aluminum crossbars to provide you with a great looking system that will last you a lifetime. Every system includes a heavy-duty remote control. The redesigned solenoid box can be mounted in three locations on the winch for maximum versatility. Each winch also includes a four way roller fairlead and a forged hook. If you're after a winch equipped with a state-of-the-art synthetic rope, look to the XRC COMP Series for the ultimate in pulling power and performance. A Smittybilt XRC winch is a complete recovery system with the muscle and reliability to bail you out of any situation.



Multiple mounting options on the control pack

**XRC RECOVERY KIT NOW AVAILABLE – SEE PAGE 130**





97495



98495

SERIES WOUND AMPHIBIOUS TECHNOLOGY  
**COMP SERIES**



Waterproof:	IP67 Rating
Rated Line Pull:	9,500lbs (4,309kgs) single-line
Motor:	6.6hp Series Wound
Control:	Remote Switch, 12' (3.7m) lead
Gear Train:	3-Stage Planetary
Gear Ratio:	161.28 : 1
Clutch:	Sliding Ring Gear
Brake:	Automatic In-Drum
Drum Size:	Diameter 2.5"
Length:	10.0" (254mm)
Fairlead:	4-Way Roller
Remote Control:	Included
Rec. Battery:	650CCA Minimum for Winching
Battery Leads:	25mm 2, 72"(1.83m)1
Finish:	Textured Black
Weight:	78.0 lbs (35.0 k)
Mounting Bolt Pattern:	10.0" x 4.5"
Overall Dimensions	(L x W x H) 20.8" x 6.3" x 7.8"
Cable:	94' 5/16" Diameter

## LINE SPEED / AMP DRAW (FIRST LAYER)

Line Pull	lbs	0	2000	4000	6000	8000	9500
	kg	0	910	1814	2720	3625	4305
Line Speed	ft/min	32.34	19.68	14.76	10.82	9.35	6.23
	m/min	9.86	6	4.5	3.3	2.85	1.9
Motor	Amps	80	165	240	320	380	435

## 9,500LBS LINE PULL AND CABLE CAPACITY

Layers of cable		1	2	3	4
Rated line pull	lbs	9500	8435	7640	7086
Per layer	kg	4305	3822	3460	3212
Cumulative cable	ft	16	42	72	94
Capacity	m	5	12	21	28

DESCRIPTION	PART#
XRC 9,500 LBS WINCH SYSTEM	97495
XRC 9,500 LBS WINCH COMP	98495

### XRC WINCH FEATURES



Magnetic Mount



Waterproof



4-Way Roller Fairlead



Steel Cable

### THE COMP SERIES DIFFERENCE



Competition Aluminum Fairlead



Synthetic Winch Rope (94 ft)

- High-grade billet aluminum material
- Reduces binding and friction caused by angled pulls and protects your synthetic rope from excessive wear
- Will not fray or tangle synthetic rope
- Standard bolt pattern

- 1/7th the weight of steel cable
- Minimal stretch, non-rotational, no kinks, curls or wire splinters
- UV and abrasion resistant
- Specially coated to prevent slippage
- Protective sleeve prevents overheating

**SMITTYBOLT**

GET THE ORIGINAL

# GEN2 XRC WINCHES



DESCRIPTION	PART#
XRC 12,000 LBS WINCH SYSTEM	97412
XRC 12,000 LBS WINCH COMP	98412

Waterproof:	IP67 Rating
Rated Line Pull:	12,000Lbs (5,454kgs) single-line
Motor:	6.6hp Series Wound
Control:	Remote Switch, 12' (3.7m) lead
Gear Train:	3-Stage Planetary
Gear Ratio:	192 2 : 1
Clutch:	Sliding Ring Gear
Brake:	Automatic In-Drum
Drum Size:	Diameter 2.5"
Length:	10.0" (254mm)
Fairlead:	Steel: 4-way roller / Synthetic: Aluminum fairlead
Remote Control:	Included
Rec. Battery:	650CCA Minimum for Winching
Battery Leads:	25mm 2, 72"(1.83m)1
Finish:	Textured Black
Weight:	Steel: 85 Lbs / Synthetic: 64 Lbs
Mounting Bolt Pattern:	10.0" x 4.50"
Overall Dimensions	(L x W x H) 22.3" x 6.4" x 9.4 "
Cable:	Steel: 94' 3/8" Diam / Synthetic: 98' 7/16" Diam

## XRC WINCH FEATURES



Magnetic Mount



Waterproof



4-Way Roller Fairlead



Steel Cable

## LINE SPEED / AMP DRAW (FIRST LAYER)

Line Pull	lbs	0	3000	6000	9000	12000
	kg	0	1360	2720	3625	5443
Line Speed	ft/min	28.208	11.15	7.872	6.232	5.248
	m/min	8.6	3.4	2.4	1.9	1.6
Motor	Amps	65	163	244	315	400

## 12,000LBS LINE PULL AND CABLE CAPACITY

Layers of cable		1	2	3	4
Rated line pull	lbs	12000	10270	9200	8800
Per layer	kg	5440	4654	4169	3852
Cumulative cable	ft	16	42	72	80
Capacity	m	5	12	21	24

## THE COMP SERIES DIFFERENCE



Competition Aluminum Fairlead



Synthetic Winch Rope (94 ft)

- High-grade billet aluminum material
- Reduces binding and friction caused by angled pulls and protects your synthetic rope from excessive wear
- Will not fray or tangle synthetic rope
- Standard bolt pattern

- 1/7th the weight of steel cable
- Minimal stretch, non-rotational, no kinks, curls or wire splinters
- UV and abrasion resistant
- Specially coated to prevent slippage
- Protective sleeve prevents overheating



# GEN2 XRC WINCHES



97515



**15,500 LB. WINCH**



97517



**17,500 LB. WINCH**

DESCRIPTION	PART#
XRC 15,500 LBS WINCH SYSTEM	97415

Waterproof:	IP67 Rating
Rated Line Pull:	15,500Lbs (7,045kgs) single-line
Motor:	6.6hp Series Wound
Control:	Remote Switch, 12' (3.7m) lead
Gear Train:	3-Stage Planetary
Gear Ratio:	330:1
Clutch:	Sliding Ring Gear
Brake:	Automatic In-Drum
Drum Size:	Diameter 3.45"(88.0mm)
Length:	10.0" (254mm)
Fairlead:	4-Way Roller
Remote Control:	Included
Rec. Battery:	650CCA Minimum for Winching
Battery Leads:	25mm 2, 72"(1.83m)1
Finish:	Textured Black
Weight:	124 Lbs
Mounting Bolt Pattern:	10.0" x 4.50"
Overall Dimensions	(L x W x H) 23.5" x 8.4" x 10.7"
Cable:	93' 25/64 Diam

## LINE SPEED / AMP DRAW (FIRST LAYER)

Line Pull	lbs	0	3000	6000	9000	12000	15500
	kg	0	1360	2722	4080	5440	7024
Line Speed	ft/min	24.11	11.15	8.7	7.54	5.7	4.3
	m/min	7.35	3.4	2.65	2.3	1.74	1.4
Motor	Amps	70	165	240	310	375	445

## 15,500LBS LINE PULL AND CABLE CAPACITY

Layers of cable		1	2	3	4
Rated line pull	lbs	15500	12968	10992	9630
Per layer	kg	7024	5877	4982	4364
Cumulative cable	ft	20.4	46	75	92
Capacity	m	6.2	14	23	28

DESCRIPTION	PART#
XRC 17 500 LBS WINCH SYSTEM	97417

Waterproof:	IP67 Rating
Rated Line Pull:	17,500Lbs (7,954kgs) single-line
Motor:	6.6hp Series Wound
Control:	Remote Switch, 12' (3.7m) lead
Gear Train:	3-Stage Planetary
Gear Ratio:	330: 1
Clutch:	Sliding Ring Gear
Brake:	Automatic In-Drum
Drum Size:	Diameter 3.45"(88.0mm)
Length:	10.0" (254mm)
Fairlead:	4-Way Roller
Remote Control:	Included
Rec. Battery:	650CCA Minimum for Winching
Battery Leads:	25mm 2, 72"(1.83m)1
Finish:	Textured Black
Weight:	132.2 Lbs
Mounting Bolt Pattern:	10.0" x 4.50"
Overall Dimensions	(L x W x H) 24.4" x 8.4" x 10.7"
Cable:	93' 7/16" Diam

## LINE SPEED / AMP DRAW (FIRST LAYER)

Line Pull	lbs	0	3000	6000	9000	12000	15000	17500
	kg	0	1360	2720	4080	5440	6800	7931
Line Speed	ft/min	22.632	10.824	7.872	6.232	5.248	3.936	3.2472
	m/min	6.9	3.3	2.4	1.9	1.6	1.2	0.99
Motor	Amps	75	140	210	270	330	390	435

## 17,500LBS LINE PULL AND CABLE CAPACITY

Layers of cable		1	2	3	4
Rated line pull	lbs	17500	14583	12411	10822
Per layer	kg	7931	6609	5625	4905
Cumulative cable	ft	19.68	45.92	75.44	93.48
Capacity	m	6	14	23	28.5



GET THE ORIGINAL

# ATV WINCHES



## XRC ATV WINCHES ATV • UTV • MARINE • TRAILER

The 2,000lb, 3,000lb and 4,000lb XRC winches are some of the most powerful ATV winches on the planet today and come standard with more features and accessories than most winches in their class. These impressive little winches are also available in the COMP winches, which are fitted with synthetic rope and aluminum fairleads.

When you're looking for performance, state-of-the-art components and quality, look to Smittybilt for a premium product at an economical price.



### 4,000 LB. ATV WINCH

DESCRIPTION	PART#
XRC 4,000 LBS WINCH SYSTEM	97204
XRC 4 COMP SERIES WINCH	98204

Rated Line Pull:	4,000 lbs.
Motor:	3.9HP Permanent Magnetic Motor
Control:	Remote Switch, 8.2' lead
Gear Train:	3-Stage Planetary
Gear Ratio:	166:1
Clutch:	Cam Activated
Brake:	Automatic In-The-Drum
Drum Size:	2"; Length 3"
Overall Dimensions:	(L x W x H) 13.1" x 4.7" x 4.4"
Cable:	Steel: 50' 7/32" Diam / Synthetic: 39' 15/64" Diam
Fairlead:	Steel: 4-Way Roller / Synthetic: Aluminum
Remote Control:	Included
Rec. Battery:	175CCA min. for winching
Battery Leads:	8mm 2 x 1.7m
Finish:	Textured Black
Weight:	Steel: 28 lbs/ Synthetic: 25 lbs
Mount. Bolt Pattern:	4.9" x 3.0"

### LINE SPEED / AMP DRAW (FIRST LAYER)

Line Pull	lbs	0	1000	2000	3000	4000
	kg	0	454	907	1360	1816
Line Speed	ft/min	23.75	16.89	12.79	8.95	5.87
	m/min	7.24	5.15	3.9	2.73	1.79
Motor	Amps	22	75	120	160	250

### 4,000LBS LINE PULL AND CABLE CAPACITY

Layers of cable		1	2	3	4	5
Rated line pull	lbs	4000	2988	2606	2311	2076
Per layer	kg	1818	1358	1185	1050	944
Cumulative cable	ft	7.8	17.3	27.8	41	49.86
Capacity	m	2.4	5.3	8.5	12.5	15.2



Four way roller fairlead



Aluminum fairlead (COMP Series)



Steel cable



Synthetic Winch Rope



11-foot remote control



Handlebar rocker switch (3K-4K)



Forged hook



Universal mounting plate





## 3,000 LB. ATV WINCH

DESCRIPTION	PART#
XRC 3,000 LBS WINCH SYSTEM	97203
XRC 3 COMP SERIES WINCH	98203

Rated Line Pull:	3,000 lbs.
Motor:	3.9HP Permanent Magnetic Motor
Control:	Remote Switch, 8.2' lead
Gear Train:	3-Stage Planetary
Gear Ratio:	171:1
Clutch:	Cam Activated
Brake:	Automatic In-The-Drum
Drum Size:	1.5" (38.1mm); Length 3.2" (81.2mm)
Overall Dimensions:	(L x W x H) 12.2" x 4.6" x 4.1"
Cable:	Steel: 50' 3/16" Diam / Synthetic: 39' 7/32" Diam
Fairlead:	Steel: 4 Way Roller / Synthetic: Aluminum Fairlead
Remote Control:	Included
Recommended Battery:	175CCA min. for winching
Battery Leads:	8mm 2 x 1.7m
Finish:	Textured Black
Weight:	Steel: 22 lbs / Synthetic: 19 lbs
Mounting Bolt Pattern:	4.9" x 3.0"

### LINE SPEED / AMP DRAW (FIRST LAYER)

Line Pull	lbs	0	1000	2000	3000
	kg	0	453	907	1360
Line Speed	ft/min	22.9	13.4	7.5	4.9
	m/min	7	4.1	2.3	1.5
Motor	Amps	21	75	155	205

### 3,000LBS LINE PULL AND CABLE CAPACITY

Layers of cable		1	2	3	4	5
Rated line pull	lbs	3000	2561	2234	1981	1779
Per layer	kg	1360	1162	1013	899	807
Cumulative cable	ft	7.5	19.03	31.5	43.96	49.86
Capacity	m	2.3	5.8	9.6	13.4	15.2

## 2,000 LB. ATV WINCH

DESCRIPTION	PART#
XRC 2,000 LBS WINCH SYSTEM	97202
XRC 2 COMP SERIES WINCH	-----

Rated Line Pull:	2,000LBS
Motor:	1.0 HP Permanent Magnetic Motor
Control:	Remote Switch, 8.2' lead
Gear Train:	3-Stage Planetary
Gear Ratio:	153:1
Clutch:	Cam activated
Brake:	Automatic In-The-Drum
Drum Size:	1.3" (32mm); L 2.9" (73mm)
Overall Dimensions	(L x W x H) 8.8" x 4.6" x 4.1"
Cable:	33' 5/32" Diam
Fairlead:	4-Way Roller
Remote Control:	Included
Rec. Battery:	175CCA min. for winching
Battery Leads:	6mm2 x 1.8m
Finish:	Textured Black
Weight:	13 lbs
Mounting Bolt Pattern:	4.9" x 3.0"

### LINE SPEED / AMP DRAW (FIRST LAYER)

Line Pull	lbs	No	500	1000	1500	2000
	kg	Load	227	454	681	908
Line Speed	ft/min	11.8	9.8	7.9	5.6	3.3
	m/min	3.6	3	2.4	1.7	1
Motor	Amps	10	26	40	61	90

### 2,000LBS LINE PULL AND CABLE CAPACITY

Layers of cable		1	2	3	4	5
Rated line pull	lbs	2000	1630	1380	1190	1050
Per layer	kg	907	739	626	540	476
Cumulative cable	ft	6.5	14	22	31	41
Capacity	m	2	4.3	6.8	9.5	12.5

# RECOVERY ACCESSORIES



## FAIRLEADS & ACCESSORIES

DESCRIPTION	PART#
<b>A</b> SLIM 4-Way Roller Fairlead	2810
<b>B</b> 4-Way Roller Fairlead	97281-47
<b>C</b> Aluminum Hawse Fairlead - XRC COMP Series	2805
<b>D</b> Aluminum Hawse Fairlead	2809
<b>E</b> Aluminum Hawse Fairlead - For ATVs	2807
<b>F</b> Hawse Fairlead Light Mount	2814
<b>G</b> License Plate Light Mount	2815
<b>H</b> License Plate Holder with Roller Fairlead Mount	4432

## BLACK BOX

The Black Box features three separate and completely lockable storage compartments to protect your winch and accessories from the weather and prying eyes.

- 4+ cubic feet of storage space
- Anti-wobble system eliminates need for external adapters
- Includes integrated D-rings mounts, recessed driving lights and illuminated light switch
- Mounts to any standard 2" receiver hitch
- Exterior: 42"W x 12"D x 13.75"H



DESCRIPTION	PART#
XRC Black Box (universal)	2806



## WINCH PLATES

- Manufactured from 1/4" steel
- Specifically for Jeep Wranglers
- Supports up to a Smittybilt 12,000lb winch
- Black powdercoat for long-lasting durability
- Pre-drilled holes. Mounting hardware included
- Some cutting required on OE bumper

YEAR	DESCRIPTION	PART#
87-06	Wrangler YJ, TJ - Winch plates for factory bumpers	2802
87-06	Wrangler YJ, TJ - Winch plates for aftermarket bumpers	2803
07-18	Wrangler JK - Winch plates	2804

## WINCH CONNECTOR KITS

- Copper cable with cover
- Quick disconnect
- Oxygen-free copper wire
- Disconnects manufactured out of high impact PVC
- Includes 3' of 3 gauge winch mount connectors with covers



DESCRIPTION	PART#
8' Winch Connector Kit	35220
24' Winch Connector Kit w/On-Off Switch	35210

## WINCH CRADLE

Attaching a winch just got easier with Smittybilt's heavy duty Winch Cradle. This kit gives you a variety of mounting options for front or rear installation because it works with any 2" receiver hitch. It is designed to accommodate most winches and includes a mounting plate for your roller fairlead.

- Manufactured out of the 3/16" and 1/4" cold rolled steel
- Finished in a two-stage satin black powdercoat
- Battery terminals sold separately
- Fits up 12k winch

DESCRIPTION	PART#
Universal Winch Cradle	2811







## A.W.S. (ALUMINUM WINCH SHACKLE)

- Provides a safer and stronger winch point than standard winch hooks
- Easy install or removal
- Precision machined from lightweight billet aircraft grade 6061 T-6 aluminum
- Max load rating of 17,000 lbs
- Rugged, durable long lasting powder coat finish

**17,000 lbs**  
MAX LOAD RATING

DESCRIPTION	PART#
A.W.S. Shackle	2820



Fits synthetic ropes and wire cables up to 1/2" in diameter



Works with roller and aluminum fairleads



Works with 3/4" and 7/8" D-Rings

## POWER RECOIL SHACKLE ROPE

- Made from durable UHMWPE material
- Spliced on one end, knotted on the other
- Breaking strength of 34,000 lbs
- 1" rope creates 6" diameter when looped
- Flexible and easily wraps around anchor points
- Floats

NOTE: Do not use on sharp corners or tow balls



DESCRIPTION	PART#
Soft Shackle Rope	13051-B

## RECOIL KINETIC ROPE

- Heavy duty and flexible Nylon 66 material available in 30' lengths
- Each rope has 12 carefully woven strands to provide better elasticity and strength, and are spliced at both ends
- Max elongation is at 30% - gives you an added 30% of length
- Each rope is carefully coated using ICO-THANE 10 material from Belgium, which has outstanding abrasion and cut resistance when applied. It gives a hard, highly extensible and tough layer over the rope and reduces dirt infiltration
- Breaking strength at 30k lbs and 60k lbs
- Abrasion, mildew- and UV-resistant
- Storage Bag included

RECOIL ROPE	PART#
1" x 30' - 30,000 lbs	CC121
1 1/2" x 30' - 60,000 lbs	CC122



## SYNTHETIC WINCH ROPES [DSK-75]

- UV and abrasion-resistant, specially coated to prevent slippage of the winch drum
- Floats - minimal weight - minimal stretch - torque free - non-rotational
- 1/7th the weight of steel cable
- Stainless steel thimble and coated hook with spring clip
- No kinks, curls or wire splinters
- Protective sleeve to prevent overheating

SYNTHETIC WINCH ROPES	PART#
5/16" x 100' 8,000LBS.	97780
3/8" x 94' 10,000LBS.	97710
7/16" x 88' 12,000LBS.	97712
1/2" x 92' 15,000LBS.	97715
9/32" x 35' 4,000LBS. (ATV)	97704



# RECOVERY ACCESSORIES



## XRC RECOVERY PACK

All-in-One Winch Kit includes:

- One XRC 9,500lbs winch
- One pair XRC Trail Gloves
- Two - 3/4" black D-ring shackles
- One 2" x 20' 20,000 lb tow strap

DESCRIPTION	PART#
<b>A</b> XRC Recovery Pack	97495P

## PREMIUM WINCH ACCESSORY BAG



- Heavy-duty 600-denier bag with strap
- 40,000lb. 8' premium tree trunk protector
- 17,000 lb. snatch strap
- Shackle kit
- Choker Chain
- Premium work gloves
- 3" x 30' recovery strap

DESCRIPTION	PART#
<b>B</b> Premium Winch Acc. Bag	2725

## WINCH COVERS

- Fits XRC 8k-12k lbs winches

DESCRIPTION	PART#
<b>C</b> XRC Winch Cover	97281-99
<b>D</b> Smittybilt Winch Cover	97281-98

## ATV WINCH BAG

- ATV winch accessory kit has all trail tools you'll need
- Pair of 1" x 8' 10,000 lb tow straps
- Snatch block with 8,000 lb rating
- Pair of 1/2" shackles with 2.0 ton weight rating

DESCRIPTION	PART#
<b>E</b> ATV Winch Accessory Bag	2729



**F**



**A**



**G**



**B**

**C**

**D**



**J**

**K**

**L**

**M**

**E**

**N**



## GEAR BAG

DESCRIPTION	PART#
<b>F</b> GEAR Bag w/ logo	2726-01

## RECOVERY STRAPS

DESCRIPTION	PART#
20,000 lbs 2"X20'	CC220
20,000 lbs 2"X30'	CC230
<b>G</b> 30,000 lbs 3"X30'	CC330
40,000 lbs 4"x20'	CC420
40,000 lbs 4"x8' Tree Strap	CC408

Cover Included

## SNATCH STRAP

- For those tough situations where a recovery strap is not strong enough
- Capable of 20% stretch underload to store kinetic energy to catapult your bogged down vehicle out
- 17,000 lbs
- Unstretched: 2 3/8" x 17.75'
- Stretched: 2 3/8" x 30'

DESCRIPTION	PART#
<b>J</b> Snatch Strap	CC120

## SNATCH BLOCKS

- 17,600 and 36,000 lb. capacity for self-recovery winches

DESCRIPTION	PART#
<b>K</b> Snatch Block 36,000 lbs	2748
<b>L</b> Snatch Block 17,600 lbs	2744

## WINCH PULL STRAP

- Fits all winch hooks
- Molded rubber grip
- Durable weather-resistant webbing

DESCRIPTION	PART#
<b>M</b> Winch Pull Strap	769402

## TOW STRAP STORAGE BAG

- Easiest way to store your tow strap
- Manufactured out of 600 denier ballistic nylon
- Holds up to a 3" x 30' tow strap
- Includes convenient grab handle
- Ends cinch down to secure strap or open up for quick use
- Bag only. Tow straps sold separately

DESCRIPTION	PART#
<b>N</b> Tow Strap Storage Bag	2791





**C.A.S.T. (CATALYST ACTIVATED SECURING TAPE)**

- Great for on-the-road repairs
- 1,000 times stronger than Duct tape
- Works on metals, wood, glass, rubber PVC and plastics
- Non-flammable and waterproof when cured
- Temperature resistant (-49°F to 293°F) (-45°C to 145°C)
- Working repairs ready in 30 minutes
- Full strength achieved in 24 hours
- Sandable and paintable
- Essential addition to any tool box or repair kit

DESCRIPTION	PART#
C.A.S.T. (Catalyst Activated Securing Tape)	2734

**TRAIL GOGGLES**

- TPU frame with PC lens
- High anti-impact lens
- Anti-fog and anti-scratch
- CE approved/ANSI certified
- Integrated dust cover
- Carrying case included
- Three interchangeable lenses: yellow, clear and gray



DESCRIPTION	PART#
Trail Goggles	1504

**XRC TRAIL GLOVES**

- EVA foam palm pads
- Reinforced finger tips
- Anatomically engineered – direct sonic welded rubber top for improved protection
- Padded palm and knuckle protection



DESCRIPTION	PART#
Trail Gloves	1505

**54" TRAIL JACK**

- Removable handle and synthetic rubber handle holder
- Steel handle 14-gauge tubing
- 1-5/16" W x 30"L with 28 sq. in. base plate

DESCRIPTION	PART#
Trail Jack 54"	2722



**R.U.T. (RECOVERY UTILITY TOOL)**

- Compact foldable military-style shovel with polycarbonate handle and neck
- Double position neck allows for picking or shoveling
- Serrated edge to handle the roughest conditions
- Soft side storage bag included

DESCRIPTION	PART#
R. U. T. (Recovery Utility Tool)	2728



**ELEMENT RAMPS**

- Sold in pairs
- Perfect traction aid for inclement weather conditions
- Heavy-duty nylon reinforced plastic construction and high traction surfaces to get you out of mud, snow, sand or any type of loose terrain
- Carrying handles and sloped entry
- Each ramp can support up to 7,700 lbs
- Stackable design that fits easily into 600D nylon carrying bag

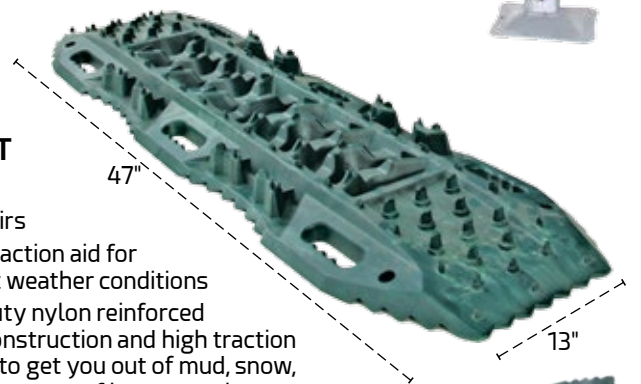

DESCRIPTION	PART#
Element Ramps (pairs)	2790



**W.A.S.P. (WINCH ANCHOR SUPPORT PLATFORM)**

- Easy grip safety handle, solid steel cast arm and 4.5 ton D-ring
- Solid breaker head to break through the toughest ground
- Three angle settings depending on the soil conditions
- Completely collapsible system
- Includes storage bag
- Flexible mast to accommodate any angle
- 40" x 24" x 30" when completely open
- Storage bag included

DESCRIPTION	PART#
W.A.S.P. Winch Anchor	2727





GET THE ORIGINAL

## RECOVERY / REPAIR

### R.A.D. RAPID AIR DEFLATOR

- 0-60psi operating range
- Large easy to read 2" dial w/ 1psi increments
- Knurled brass knobs
- Protective rubber gauge housing
- Nylon braided hose
- Quick and accurate
- MOLLE PAL bag included



DESCRIPTION	PART#
<b>A</b> Rapid Air Deflator	2823



NEW PRODUCT

### 10-PIECE NUTSERT TOOLS

New "Quick-change head" design allows for easy changing of mandrels and nose pieces. Unique spring loaded mandrel automatically locks the mandrel lock pin for the fastest mandrel changes on the market.

#### INCLUDED MANDRELS

##### STANDARD

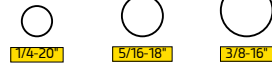

##### METRIC

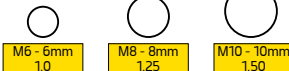

1-Nutsert installation tool

3-SAE Mandrels

3-Metric Mandrels

2-Mandrel lock pins

1-Mandrel quick change tool



Perfect tool to install the following Smittybilt products:

<b>M6-1.0</b>	Your choice
<b>M8-1.25</b>	Flux Flares (76839)
<b>M10-1.5</b>	XRC Body Cladding (76886,76887), XRC Rock Sliders (76888,76889,76853), XRC Armor (76880,76881,76882), XRC Tailgate table (2793), Exoskeleton (76840,76841), XRC Armor Skins (76980,76981,76982)

DESCRIPTION	PART#
<b>I</b> Nutsert Tools	2834



### TORX - MULTI TOOL

- Nine chrome Vanadium bits included
- T15 to T55
- Ballistic nylon carrying case included
- T50 (tamper proof), 3/8" ratchet and steel rail included



DESCRIPTION	PART#
<b>H</b> 9-Piece Torx Set - T15 to T50	2830

### TIRE REPAIR KIT

- Compact soft pack for easy stowing in glove box or under car seat
- Self-vulcanizing plugs (30)
- Rugged aluminum hand tools: dual head tire pressure gauge, needle nose pliers, folding knife
- Includes: lubricant, extra valve stems, side wall bailing wire, interior tire patches
- Easy-to-follow illustrated instructions



DESCRIPTION	PART#
<b>B</b> Tire Repair Kit	2733



**COMP-AIR**

- 250PSI Integrated Regulator
- Max. 22 cubic feet per min (680 Liters per min)
- Inflates tires quick and easy
- Enough power to run small air tools
- Completely portable - can be used for off-road, RV or the everyday use
- Air hose, air chuck and carrying bag included



DESCRIPTION	PART#
<b>C</b> Comp-Air 10lbs Air Tank	2747
<b>D</b> Comp-Air Air Tank Roll Bar Mount	2749

**2.5 AIR TANK**

- Includes push-in fittings (male and female), quick connect studs, 90° elbows, drain cock, nylon hose, pressure gauge, and all necessary hardware
- Up to 150 Max. PSI



DESCRIPTION	PART#
<b>E</b> 2.5 Gallon Air Tank	99210-2

**AIR COMPRESSORS**

- 12-volt motor powered directly from car battery
- Quick release 24 ft. coil hose
- Includes E-Z twist brass inflator, three easy-needle adapters, heavy-duty clip connectors and convenient nylon carrying bag
- 10 ft. power cord



DESCRIPTION	PART#
<b>F</b> Air Compressor 5.65 CFM	2781
<b>G</b> Air Compressor 2.54 CFM	2780

SPECIFICATIONS	2780	2781
Max. Airflow Per Min.	72ltrs.	160ltrs.
Max. Voltage	13.8v	13.8v
Max. Amp. Draw	30A	45A
Max. Restart Pressure	150PSI	150PSI
Max. Operating Temp.	140°F	140°F
Max. Cont. Cycle Time	40mins.	40mins.
Max. Cont. Cycle Time	40PSI @750F	40PSI @750F





GET THE ORIGINAL

## POWER & LIGHTING



UP TO:  
**10** HOURS | **1,000** LUMENS

**TR-9**  
**1K LUMENS**  
HIGH-POWERED LED



### TR-9 HIGH POWERED LED

The TR-9 rechargeable LED flashlight is constructed of heavy duty aluminum that can handle punishment and provides high light output with low power draw.

- Brightness up to 1,000 Lumens
- T-6061 Mil Spec Type 3 hard anodized finish
- Tactical grip handle, tactical strike crown head
- IP68 Rating waterproof up to 35 ft., impact resistant up to 5 ft. drop
- 5-setting on-off switch with low power monitoring system
- Rechargeable 18650-type Li-ion batteries with overheat protection

DESCRIPTION	PART#
TR-9 High Powered L.E.D.	L-1406

### U.F.O. (UNIVERSAL FLASHING OBJECT)

- Compact and visible up to a mile
- Standard red LED in emergency flashlight mode
- Magnetic back can be mounted to vehicle for optimum visibility
- Waterproof/ideal for marine use: Coast Guard-approved "SOS" Morse Code
- Durable construction: high-grade military polymer shell that is strong enough to withstand being driven over
- High-capacity CR123 lithium battery has up to one year of storage life



DESCRIPTION	PART#
UFO LED Safety Light	L-1409

### HALO HEADLAMP / DOME LIGHT

- For convenient use as a dome light
- Elastic headband quickly adjusts to fit your sun visor
- On/Off Switch and three LED light settings (high/low/flash)
- Cool running, high output CREE XP-E2 LED – head has integrated tilt control
- Water resistant with IPX 4 rating, ABS housing for impact resistance
- Spot beam, regulated output
- Output/run: High: 120 lumens/5hrs; Low: 38 lumens/22 hrs; Strobe: 120 lumens/30 hrs. Spot beam distance: up to 54 m/177"
- Weight: 86.5grams with batteries. Three AAA batteries included



DESCRIPTION	PART#
HALO Headlamp	L1410

### CLINOMETERS

- Two gauges in one: left displays side-by-side angle and right displays front-to-back
- Graphic readouts show precise angle in degrees
- Gauges illuminate for night vision (791005 only)
- Compass included (791006)



DESCRIPTION	PART#
<b>A</b> Clinometer	791005
<b>B</b> Clinometer with Compass	791006

### GLOVE BOX LED LIGHT

- 16 super bright LED wand
- 8 LED spot light
- Laser pointer
- Magnetic base
- Includes AAA batteries



DESCRIPTION	PART#
GB8 Light (Red)	L-1407RD
GB8 Light (Silver)	L-1407SL
GB8 Light (Blue)	L-1407BU
GB8 Light (Black)	L-1407BK



## ALUMINUM DROP BALL MOUNT



- Hard anodized for weather resistance
- 6061 aluminum, forged for superior strength
- Gross trailer weight: 8,000 lbs
- Tongue weight: 800 lbs
- 2" x 2" dor standard receiver, 1" shank hole
- SAEJ684 V-5, Class 4 rated

DESCRIPTION	PART#
Aluminum 2" Receiver 2" Drop	2932
Aluminum 2" Receiver 4" Drop	2934
Aluminum 2" Receiver 6" Drop	2936
Aluminum 2" Receiver 8" Drop	2938
Aluminum 2" Receiver 10" Drop	2940

## STEEL DROP BALL MOUNTS



- Hammer forged harden Q235 steel
- Robotic welded, reinforced gussets on drop ball mounts 6"+ for added strength
- Corrosion and rust rotected
- Class III rated. Up to 6,000lbs GTW(8" drop rated 500/5000) (10" drop rated 350/3500)
- Up to 600lbs tongue weight
- 1" shank hole, fits 2 x 2 receivers

DESCRIPTION	PART#
Steel 2" Receiver 2" Drop	2902
Steel 2" Receiver 4" Drop	2904
Steel 2" Receiver 6" Drop	2906
Steel 2" Receiver 8" Drop	2908
Steel 2" Receiver 10" Drop	2910

## HITCH BALL



- Chrome plated with 1" shank
- Cold forged balls for added towing strength

DESCRIPTION	PART#
2" Receiver Ball	2900
2 5/16" Receiver Ball	2901

## LOCKING HITCH PIN



- 5/8" pin and clip
- Zinc-plated for long life
- Key style clip for easy removal

DESCRIPTION	PART#
Hitch Pin	2911
5/8" Diameter Pin w/ Lock and Key	2921

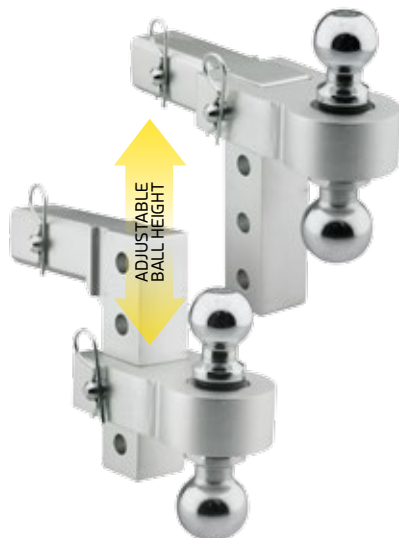

## ALUMINUM DROP HITCH

This lightweight aluminum drop hitch is hard anodized for weather resistance and forged for superior strength. With this Class 4 rated hitch, you'll be able to haul up to 6,000lbs of toys to any destination.

- Hard anodized for weather resistance and finish retention, forged for superior strength
- Gross trailer weight up to 6,000 lbs
- Tongue weight up to 600 lbs
- 2x2 for standard receivers
- 6061 aluminum with 1" shank hole
- SAEJ684 V-5, Class 4 rated

DESCRIPTION	PART#
2" Receiver-2"/2-5/16" Ball, 6" Adjustable	2926
2" Receiver-2"/1-7/8" Ball, 6" Adjustable	2925



## RECEIVER TOW HOOK

- Fits standard 2" receiver
- 10,000 lbs. weight rating

DESCRIPTION	PART#
Receiver Tow Hook (Black)	7610



## JEEP TOW HOOK KITS

DESCRIPTION	PART#
All CJ & Wrangler (Chrome)	7505
All CJ & Wrangler (Black)	7605
97-06 Wrangler TJ, pair (Black)	7786



## D-RINGS

DESCRIPTION	PART#
3/4" D rings 4.75 Tons Each (Red)	13047R
1/2" D rings 2.0 Tons Each (Black)	13046B
3/4" D rings 4.75 Tons Each (Black)	13047B
7/8" D rings 6.5 Tons Each (Black)	13048B
1/2" D rings 2.0 Tons Each (Zinc)	13046
3/4" D rings 4.75 Tons Each (Zinc)	13047
7/8" D rings 6.5 Tons Each (Zinc)	13048



## QUICK DISCONNECT D-RING

DESCRIPTION	PART#
3/4" D rings 4.75 Tons Each (Zinc)	13049
7/8" D rings 6.5 Tons Each (Zinc)	13050
3/4" D rings 4.75 Tons Each (Black)	13049B
7/8" D rings 6.5 Tons Each (Black)	13050B



## RECEIVER HITCH D-RING

- Fits standard 2" receiver
- Up to 6.5 tons weight rating

DESCRIPTION	PART#
Receiver D-Ring (Zinc)	29312
Receiver D-Ring (Black)	29312B



## JEEP 2" RECEIVER HITCH

- Class III
- Factory-style towing solution for your JK
- Gloss black powdercoated
- 2" standard receiver hitch

DESCRIPTION	PART#
07-17 JK Factory Style Receiver Hitch	JH45



GET THE ORIGINAL

# TOWING

## TOW BAR

- When it's time to pull your Jeep behind your truck or motor home and need a reliable tool
- Kit includes 2" coupler, two universal brackets, two D-Ring brackets (works on Smittybilt bumpers only) and safety chains
- 5000 lb GVW, 5,000 pound tow capacity
- Fits any standard 2" ball



87451 Tow Bar Adapter Bracket  
For use with bumpers 76892, 76724, 76807



DESCRIPTION	PART#
<b>A</b> Universal Tow Bar Kit	87450
<b>B</b> Tow Bar Adapter Bracket	87451

## WEIGHT DISTRIBUTION SYSTEM

- Includes hitch, adjustable ball mount, bolt-together adjustable shank, hookup brackets, spring bars and chains
- Up to 1,400lb maximum tongue weight
- Up to 14,000lb maximum gross weight rating
- Adjustable ball mount height for different lift sizes, 5.5" max drop
- Forged, tapered, round spring steel bars for a smoother ride
- Operated with a positive cam latching hook up action
- 2 -5/16" ball included



DESCRIPTION	PART#
<b>C</b> Weight Distributing System	87550

## JEEP TOW WIRING HARNESS

- Simple plug and play - easy install with no cutting, splicing or taping
- Takes the hassle out of trying to splice wires together and figuring out which wire goes where
- Smittybilt O.E. style wire adapter designed to plug right into the OEM wire harness for an effortless plug and play feature
- Custom-engineered to fit your vehicle and designed to OEM specifications
- Connectors are highest OEM quality to ensure watertight seal and a perfect connection
- Includes lead wires for auxiliary exterior lighting

MODEL	DESCRIPTION	PART#
<b>D</b> 07-17 Wrangler (JK) 2/4DR	Wiring Harness	2912

Auxiliary backup light pigtail



## BEAVER STEP

- Stepping point to get in truck bed
- Universal use in any 2" receiver
- Hammer forged carbon steel and high gloss powdercoat
- 10,000lbs rated tow strap point



DESCRIPTION	PART#
<b>E</b> Beaver Step	27046B

NOTE: Secure tow strap while in use to prevent accidental slippage.  
 DISCLAIMER: The strength of this unit likely exceeds your Jeep's capacity to pull the load so as with all towing, use caution. Safe use requires accessories such as safety chains, magnetic light kit and wiring for lights.









GET THE ORIGINAL

# INDEX

## 0-9

.50 AMMO CAN	114
10X MODULAR BUMPER	38
54" TRAIL JACK	13

## A

ACCESSORIES FOR JEEPS	100
ACCESSORY MOUNTS	22, 67
A.C.T. COMPACT TOOL	115
ADJUSTABLE DOOR STRAPS	102
ADVANTAGE WARRANTY	8
ADVENTURE BOX	24
AIR COMPRESSOR	133
AIR TANK	133
ALUMINUM DROP HITCH	135
ALUMINUM WINCH SHACKLE	129
AMMO CAN	114
AM-MOUNTS	20
ANNEX FOR TENT	110
ARCTIC FRIDGE/FREEZER	113
ARMOR FOR JEEPS	53
ATLAS BUMPER	28
ATLAS DOOR STEPS	110
ATLAS ROCK SLIDERS	155
ATV WINCHES	126
ATV WINCH BAG	130
AWNING	112
AXE	115

## B

BEAVER STEP	136
BILLET GRILLE	102
BLACK BOX	128
BOW ASSEMBLY	81
BOWLESS COMBO TOP KIT	78
BRIEFS	82
BUG OUT SAW	115

BUMPERS, 10X MODULAR	38
BUMPERS, ATLAS	28
BUMPERS, CARBINE	44
BUMPERS, M-1	13
BUMPERS, M1A2	10
BUMPERS, M.O.D.	39
BUMPERS, SRC CLASSIC	47
BUMPERS, SRC GEN1	46
BUMPERS, SRC GEN2	30
BUMPERS, STINGER	45
BUMPERS, TUBULAR	49
BUMPERS, XRC GEN1	40
BUMPERS, XRC GEN2	30

## C

CAGE KITS	70
CARBINE BUMPER	44
CARGO MANAGEMENT	24
CARGO NET	22, 67
CARGO RESTRAINT	85
C.A.S.T.	131
CLASSIC BUMPER	50
CLOAK MESH TOP AND SIDES	84
CLINOMETER	134
COMP-AIR	133
COMPLETE HOOD KIT	103
CONTRACTORS RACK	23
COVERS (BRIEFS)	82
COVERS (CAB)	87
CROSS BAR BRACKET KIT	22, 67

## D

DEFENDER RACK	18, 66
DOME LIGHT	134
DOOR HINGE	103
DOORS	60
DOOR SURROUNDS	81, 83
D-RINGS	135

DROP BALL MOUNT	135
DS-MOUNTS	20
DUAL BATTERY TRAY	102

## E

ELEMENT RAMPS	131
ENTRY GUARDS	104
EPS INVERTER GENERATOR	113
EURO HEADLIGHT COVERS	102
EXOSKELETON	70
EXTENDED TOP	82

## F

FAIRLEADS	128
FENDER FLARES	15, 64
FIRST AID KIT BAG	114
FLUX FLARES	62
FRIDGE/FREEZER	113

## G

GAS CAN HOLDER	24
GAS COVER	104
G.E.A.R. ACCESSORIES	95
G.E.A.R. BAG	130
G.E.A.R. CUSTOM SEAT COVERS	193
G.E.A.R. UNIVERSAL TRUCK SEAT COVER	24
GEN2 WINCHES	116
GENERATOR	113
GLOVES	131
GLOVE BOX LED LIGHT	134
GRAB HANDLE	97
GRILLES	15, 63
GRILLE INSERTS	105

## H

HALO HEADLAMP	134
HARD TOPS	74
HARD TIP HOIST	76



HD/HDS-MOUNTS	20
HEADLIGHT COVERS	105
H.E.M.I. VENTED HOOD	59
HITCH BALL	135
HOODS	58
HOOD HINGE	102
HOOD LATCH	103

## I

IRACK	69
-------	----

## J

JERRY GAS CAN HOLDER	24
----------------------	----

## K

KNIVES	115
--------	-----

## L

LED FLASHLIGHT	132
LICENSE PLATE RELOCATION BRACKET	101
LIGHT BAR MOUNTING KIT	22,67
LIGHT BRACKET	22, 101
LIGHT CAGE	22,67
LIMB RISER	100
LOCKING HITCH PIN	135

## M

M1A2 BUMPERS	10
M-1 BUMPERS	13
M-1 FENDER FLARES	14
M-1 GRILLES	15, 63
MACHETE	115
MAG-ARMOR	65
MESH BAG	114
MESH TOPS	84
M.O.D. BUMPERS	39
MOLLE SPORT BAR COVER KIT	96

## N

NERF STEPS	16,52
NUTSERT TOOL	132

## O

OE-STYLE BOW ASSEMBLY	81
OE-STYLE DOOR SURROUND	81
OFF-ROAD ORGANIZER	98
OVERLANDER TENT	110

## P

PICK-IT-UP MESH BAG	114
PIVOT TIRE CARRIER	51
POWER RECOIL SHACKLE ROPE	129
PREMIUM GRAB HANDLE	97
PREMIUM WINCH ACCESSORY BAG	130
PROT3K REPLACEMENT SOFT TOP	77

## Q

QUICK DISCONNECT D-RING	135
-------------------------	-----

## R

RACKS	18,66
RAMPS	131
RAPID AIR DEFLATER	132
RATCHET STRAP	24
RECEIVER HITCH	135
RECEIVER HITCH D-RING	135
RECEIVER RACK	24
RECEIVER TOW HOOK	135
RECOIL KINETIC ROPE	129
RECOVERY ACCESSORIES	130
RECOVERY STRAPS	130
RECOVERY UTILITY TOOL (R.U.T.)	131
REPAIR	131
REPLACEMENT SEATS	90
REPLACEMENT SOFT TOPS	77,79

ROCKER GUARDS	56
ROCK SLIDERS	54
ROLL BAR ACCESSORIES	96
ROOF RACKS	68
ROPES	129
RUGGED RACK	23

## S

SAFARI HARD TOP	74
SCOUT TRAILER KIT	108
SEATS	89
SEAT COVERS	92
SECURE LOCK BOX	99
SECURITY FLOOR CONSOLE	99
SIDE ARMOR	61
SKID PLATES	65
SKINS	61
SLANT HARD TOP	75
SLANT TIRE CARRIER ADAPTER KIT	50
SMARTCOVER	25
SNATCH BLOCK	130
SNATCH STRAP	130
SOFT GEAR	114
SOFT GOODS	82
SOFT TOPS	77
SPARE TIRE COVER	83
SPARE TIRE MOUNT	22,67
SRC CAGE KIT	71
SRC CARBINE BUMPER	44
SRC CLASSIC BUMPER	47
SRC CLASSIC SIDE PROTECTION	57
SRC GEN1 BUMPER	46
SRC GEN2 BUMPER	34
SRC GEN2 TUBE DOORS	61
SRC ROCK SLIDERS	56
SRC SIDE ARMOR	56
SRC STINGER	45
SRC TUBE DOORS	61



GET THE ORIGINAL

# INDEX

## S

STANDARD TOP	82
STEEL DROP BALL MOUNTS	135
STEPS	52
STINGER	45
STINGRAY VENTED HOOD	58
STORAGE BAGS	88
STORAGE BOOT	83
STORAGE VAULT	98
SURE STEPS	17,52
SYNTHETIC WINCH ROPES	129

## T

TAILGATE	50
TAILGATE BARS	83
TAILGATE TABLE	101
TENT	110
TIRE CARRIERS	50
TIRE COVER	83
TIRE RELOCATION BRACKET	50
TIRE REPAIR KIT	132
TONNEAU COVER	25,82
TOOLS 115	
TOPS	72
TORX MULTI-TOOL	132
TOW BAR	136
TOW BAR ADAPTER	136
TOW HOOK KITS	135
TOWING	135
TOW STRAP STORAGE BAG	130
TOW WIRING HARNESS	136
TR-9 LED FLASHLIGHT	134
TRAIL AXE	115
TRAIL BAG	113
TRAIL GOGGLES	131
TRAIL GLOVES	131
TRAIL JACK	131

TRAIL MIRRORS	102
TRAIL SHADE	112
TRIM	102
TRUCK TIE DOWN	24
TUBE DOORS	60
TUBULAR BUMPERS	49

## U

UFO (UNIVERSAL FLASHING OBJECT)	134
---------------------------------	-----

## V

VAULTED GLOVE BOX	98
-------------------	----

## W

WEIGHT DISTRIBUTION SYSTEM	134
WINCH ANCHOR (W.A.S.P.)	131
WINCH ACCESSORIES	128
WINCH CONNECTOR KITS	128
WINCH COVERS	130
WINCH CRADLE	128
WINCHES	116
WINCHES X20	118
WINCHES XRC	122
WINCH PLATES	128
WINCH PULL STRAP	130
WIND BREAKERS	83
WINDSHIELD CHANNELS	82
WINDSHIELD HINGES	103

## X

X20 WINCH	118
XRC BODY ARMOR	62
XRC BODY CLADDING	63
XRC BOLT-ON FLARE	64
XRC CORNER GUARDS	63,64
XRC FENDERS	63
XRC FLUX FLARES	61
XRC FOOT PEGS	100

XRC GEN1 BUMPER	40
XRC GEN2 BUMPER	30
XRC GEN2 TIRE CARRIER	33,37
XRC JK BODY ARMOR	61
XRC LIGHT BAR ASSEMBLY	101
XRC LOCKABLE HOOD CATCH	103
XRC PERFORMANCE SEATS	89
XRC REAR QUARTER PANEL SKINS	61
XRC RECOVERY PACK	130
XRC ROCK SLIDERS	54,64
XRC SKID PLATES	65
XRC SLANT TIRE CARRIER ADAPTER	51
XRC TAILGATE	50
XRC TRAIL GLOVES	131