



the
way
to
fish[®]

table of contents

DOWNRIGGERS

- 6 what is a Downrigger
- 7 choosing your downrigger
- 8 high performance
- 10 depthpower
- 12 manual
- 14 compact
- 16 laketroller

DOWNRIGGER MOUNTS

- 18 downrigger mounts
- 19 compact downrigger mounts
- 19 downrigger dual rod holder

DOWNRIGGER PARTS & ACCESSORIES

- 20 parts & accessories
- 22 downrigger tackle
- 23 cable & line

LINE RELEASES

- 26 power grip plus
- 26 mini power grip plus
- 27 snapper
- 27 mini snapper

LINE PULLERS

- 28 electric
- 28 manual
- 29 bait jars

ROD HOLDERS

- 30 R-5
- 32 orca
- 34 striker
- 36 power lock
- 40 rocket launcher
- 40 rodmaster II

- 41 rodmaster
- 41 side winder
- 42 baitcaster spinning
- 44 fly rod

MOUNTS

- 46 electronic mounts
- 49 transducer mounts
- 50 ball mounts
- 54 post mounts
- 55 adaptors
- 55 triple mounting system
- 58 low profile track
- 58 gear head
- 65 glue/stick on mounts

ACCESSORIES

- 60 inflatable accessories
- 62 track adaptor
- 64 fishing accessories
- 66 extensions & adaptors
- 68 bait board
- 69 anchor lock
- 70 boating accessories

PADDLE SPORTS

- 72 paddle sport accessories
- 73 kayak stabilizer
- 74 kayak accessories
- 76 kayak fishing starter pack

SAFETY EQUIPMENT

- 78 sea-light
- 79 pumps

JORDAN-SCOTTY

- 80 fish egg incubator systems

legend

-  **Water Surface**
Best suited for still water
-  **Vessel Recommendation**
Suited for paddle sports
-  **No assembly required**
-  **Factory and field tested**
-  **Colour options**

Scotty®

SINCE 1952



SCOTTY: THE WAY TO FISH!'

In 1952, Blayney Scott and his wife Almeda Scott started a small company in Victoria, British Columbia that pioneered the use of plastics in the manufacturing of salmon fishing, lures and other marine products. From humble beginnings, Scotty Manufacturing Ltd. evolved to produce thousands of products under the Scotty trademark which are sold to the fishing, marine, outdoor and firefighting industries worldwide. The company is now situated near the YYJ Victoria International Airport in an 85,000 sq.ft. manufacturing plant built in 2000, and has recently expanded.

The Scotty trademark has become recognized to mean product excellence. The total commitment to quality, fair pricing and unmatched service means our customers everywhere can expect reliability and satisfaction from every product that carries the Scotty name. This commitment has taken us to where we are today and will hopefully serve us well for many years to come. All products are backed by years of manufacturing experience and the highest quality customer service. Excellent vendor support and a superior product have made Scotty a leader in the fishing industry.

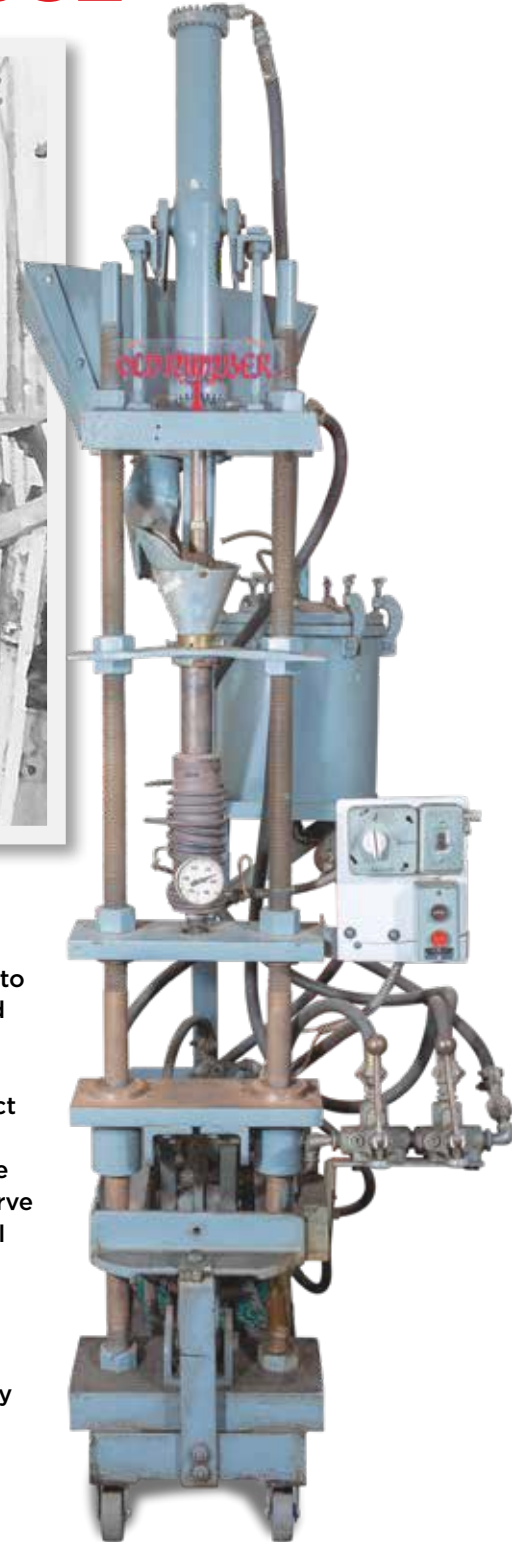

SCOTTY | location



downriggers explained

superior line release technology

Downriggers were created for one principal reason: to allow anglers to troll their lures at a specific depth.

Years of testing and practical use have shown that a moving bait or lure in the water, trolled at the depth where fish are present, is the best way to ensure a hookup and to get results.

Downriggers improved both trolling results, and the fun factor. They put the sport back in sport fishing.

The earliest Downriggers were very simple in form, generally consisting of a spool of wire mounted to the boat with a heavy weight hung on the end of the wire. The lure or bait was attached directly to the Downrigger weight and did not release when a fish struck.

The angler had to wind up both the weight and the fish. This concept of deep trolling became popular with sport fishermen when the idea of attaching a rod to the Downrigger, by means of a release clip, was introduced.

A release clip is attached to the wire and then the fishing line from the rod is clipped into the release. The Downrigger weight is then lowered to precisely the depth required.

When a fish hits, the line is released from the Downrigger wire, leaving the heavy weight on the Downrigger.

The angler is then free to fight the fish on the rod and reel alone, without the added drag of heavy lines and trolling weights used in the past. Scotty introduced its first Downrigger over 40 years ago and now produces the most complete range of Downriggers and accessories in the world.

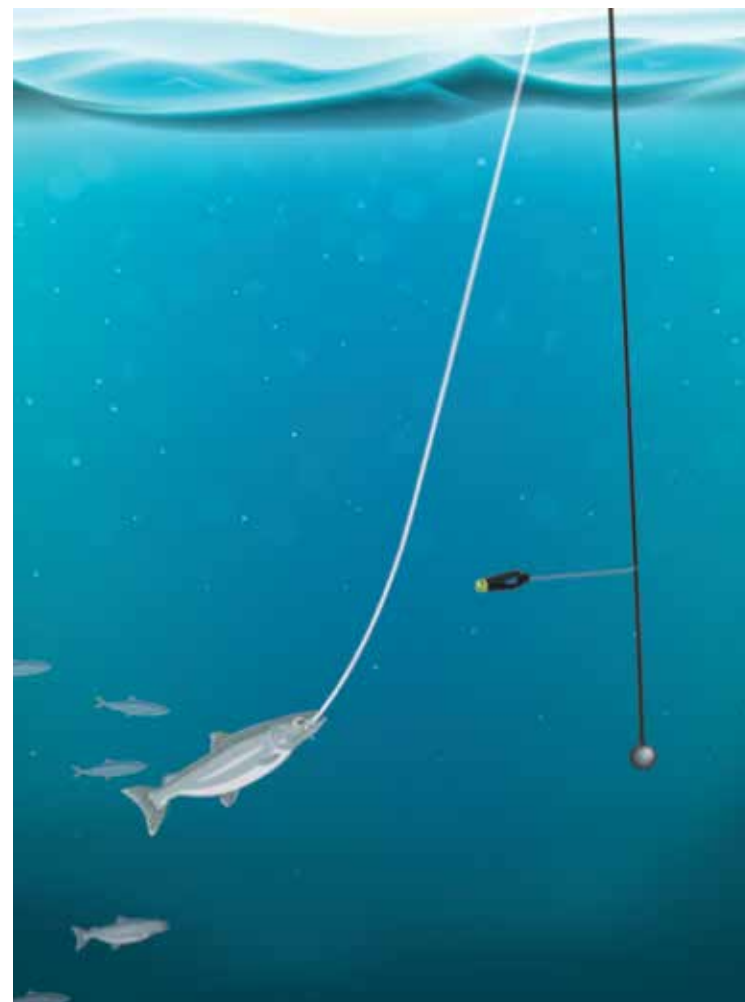
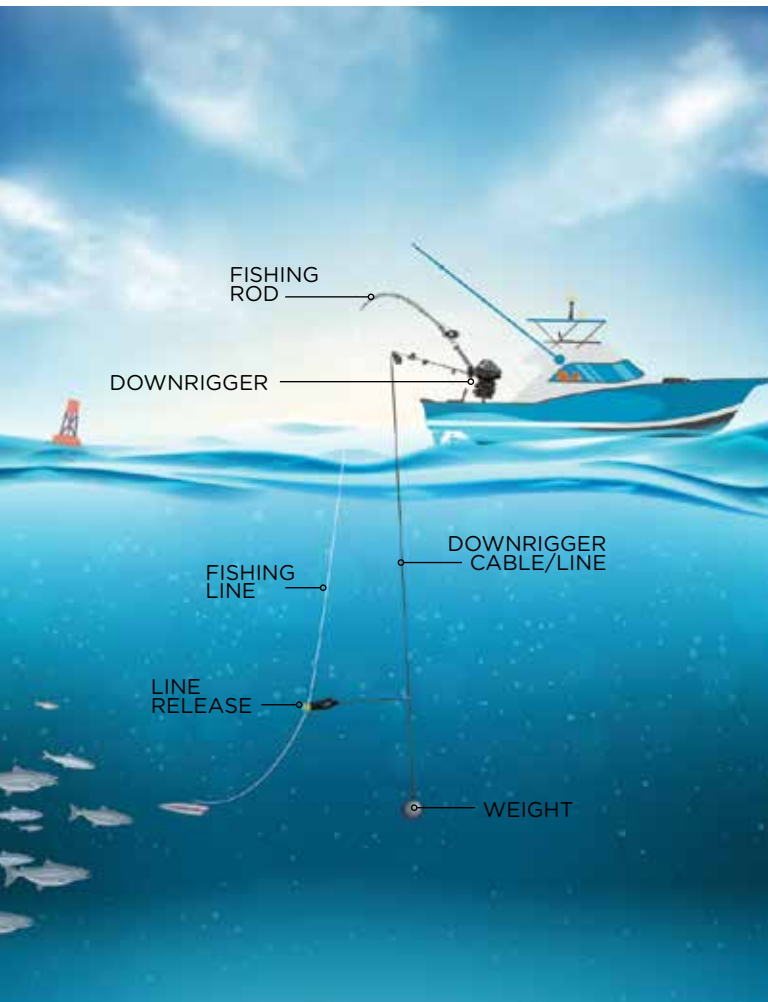

1 Clip your fishing line to the Downrigger line using a Scotty Power Grip line release.

2 Loosen the drag on your fishing reel and carefully let the Downrigger line out to a specific depth.

3 When a fish strikes it pulls your fishing line out of the release and you are free to fight the fish on the rod and reel.

choosing your downrigger

compare our models to find a perfect fit for you

electric downriggers

All Electric Models have 12 v Marineco™ corrosion resistant plug + socket, locking tilt up mount, large surface automatic brake, spray protected positive-drive depth counter, Kevlar™ belt driven and an auto stop with jog button feature.

	HIGH PERFORMANCE			DEPTHPOWER				
STAINLESS STEEL CABLE	2106	2106B	2116	1099	1101	1106	1106B	1116
• premium test 150 lb.				250 ft.	250 ft.	250 ft.		250 ft.
• premium test 180 lb.	300 ft.		300 ft.					
BRAIDED LINE							300 ft.	
• premium test 200 lb.								
• premium test 250 lb.		300 ft.						
16 POSITION SWIVEL MOUNTING BASE	✓	✓	✓	SOLD SEPARATELY	✓	✓	✓	✓
POWER GRIP PLUS LINE RELEASE MODEL NUMBER	1170	1170	1170 & 1171	1170	1170	1170	1170	1170 & 1171
ROD HOLDER MODEL	358 RODMASTER II	358 RODMASTER II	447 DUAL ROCKET LAUNCHER	355 RODMASTER II	358 RODMASTER II	358 RODMASTER II	358 RODMASTER II	247 DUAL ROD HOLDER
WEIGHT STORAGE HOOK	✓	✓	✓	SOLD SEPARATELY	SOLD SEPARATELY	SOLD SEPARATELY	✓	✓
STAINLESS STEEL BOOM LENGTH	36" - 60" TELESCOPIC	36" - 60" TELESCOPIC	36" - 60" TELESCOPIC	24" FIXED	30" FIXED	36" - 60" TELESCOPIC	36" - 60" TELESCOPIC	36" - 60" TELESCOPIC
HIGH PERFORMANCE				DEPTHPOWER				
Weight	12lb.	15lb.	20lb.	7 lb.	10lb.	15lb.		
Retrieval Speed	304 ft./min.	295 ft./min.	260 ft./min.	235 ft./min.	222 ft./min.	203 ft./min.		
Amperage Draw	13 amps	14.5 amps	19.5 amps	4 amps	5 amps	8 amps		

LIMITED *****
LIFETIME WARRANTY

manual downriggers

	MANUAL			COMPACT			LAKETROLLER	
	1080 STRONGARM	1085 STRONGARM	1091 LONGARM COMBO PACK	1050 DEPTHMASTER	1050MP MASTERPACK	1060 DEPTHKING	1071 CLAMP MOUNT	1073 BRACKET MOUNT
PREMIUM 150 LB. TEST STAINLESS STEEL CABLE	200 ft.	200 ft.	200 ft.	200 ft.	200 ft.	200 ft.	100 ft.	100 ft.
LOCKING TILT-UP MOUNT	✓	✓	✓	N/A	N/A	N/A	N/A	N/A
POWER GRIP PLUS LINE RELEASE MODEL NUMBER	1170	1170	1170	1170	1170	1170	1181 MINI POWER GRIP PLUS	1181 MINI POWER GRIP PLUS
ROD HOLDER MODEL	355 RODMASTER II	358 RODMASTER II	358 RODMASTER II	355 RODMASTER II	355 RODMASTER II	355 RODMASTER II	N/A	N/A
WEIGHT STORAGE HOOK	SOLD SEPARATELY	SOLD SEPARATELY	SOLD SEPARATELY	N/A	N/A	N/A	N/A	N/A
STAINLESS STEEL BOOM - LENGTH	24" FIXED	30" FIXED	36" - 60" TELESCOPIC	23" FIXED	23" FIXED	23" FIXED	12" FIXED	12" FIXED
LARGE SURFACE AUTOMATIC BRAKE	✓	✓	✓	✓	✓	✓	MANUAL DRAG BRAKE	MANUAL DRAG BRAKE
SPRAY PROTECTED POSITIVE-DRIVE DEPTH COUNTER	✓	✓	✓	✓	✓	✓	N/A	N/A
SPOOL DIAMETER FT. PER TURN	2 ft.	2 ft.	2 ft.	1 ft.	1 ft.	2 ft.	1 ft.	1 ft.

HIGH PERFORMANCE

downrigger

highest performance and speed

Scotty High Performance Electric Downriggers have reached the highest performance and reliability standards yet, while remaining competitively priced. Thousands of anglers now enjoy the superior speed, power and years of reliability that only Scotty offers. Scotty's custom designed marine components and final quality control tests produce a Downrigger that is unmatched in the industry.

FEATURES INCLUDED WITH HIGH PERFORMANCE MODELS

Line Release
Power Grip Plus 18" (1170)

Rod Holders
Rod Master II 2106 & 2106B models (358)
Dual Rod Holders 2116 model (447)

Mounts
Tilt-up Mounting Bracket (1023)

Swivel Mount (1026)

Right Angle Marincó Receptacle Mount (2128)

Auto Stop (1121)

4 Auto Stop Beads

Weight Storage
Storage Hook (1148)

Power Source
Marincó 12V Plug & Receptacle (2125)

Power cord length, 40"

Downrigger Cable/Line
300 ft. of 180 lb. test stainless steel cable, 300 ft. of 250 lb. test braided line (2106B model)

Counter
Digital Illuminated LCD (2133)

Factory & Field Tested

Fully Assembled

Warranty
Limited Lifetime

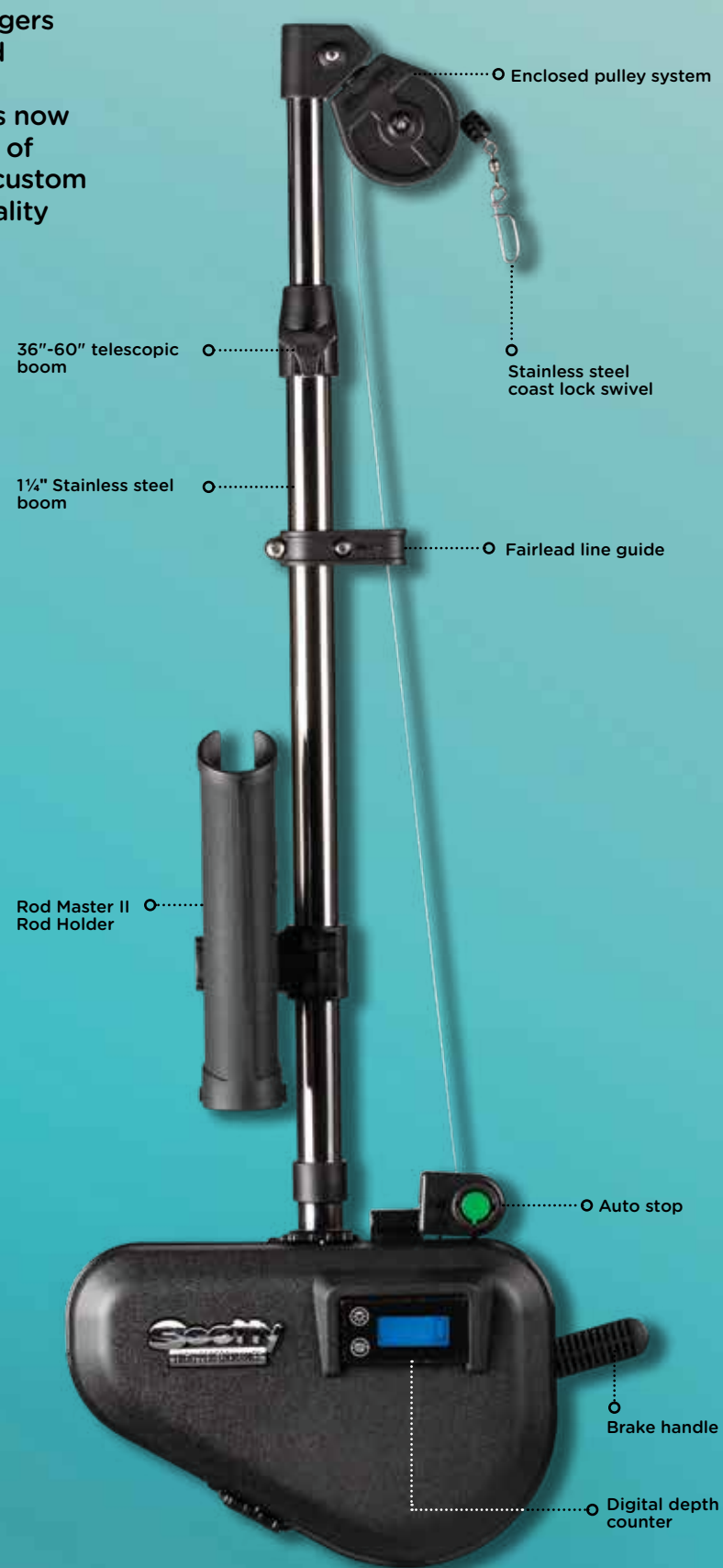

2106 | high performance

The Downrigger of choice for serious fishermen. Unmatched in power, performance and reliability. Equipped with 300 ft. of 180 lb. test stainless steel cable. 36"-60" long 1 1/4" telescopic boom.

2106B | high performance

Power and performance packaged with our strongest braided Downrigger line. Equipped with 300 ft. of 250 lb. test braided line. 36"-60" long 1 1/4" telescopic boom.

2116 | high performance propack

The number one choice in performance Downriggers for the charter captain. Equipped with 300 ft. of 180 lb. test stainless steel cable and our stainless steel rocket launcher dual rod holders. 36"-60" long 1 1/4" telescopic boom.



DEPTHPOWER

downrigger

superior speed, power and years of reliability

Scotty Depthpower Electric Downriggers have the highest performance and reliability standards ever, while remaining competitively priced. Thousands of fishermen now enjoy the superior speed, power and years of reliability that only Scotty offers. From custom designed marine motors to the final quality control tests, Scotty performance is unmatched in the industry.

FEATURES INCLUDED WITH DEPTHPOWER MODELS

Line Release
Power Grip Plus 18" (1170)

Rod Holder
Rod Master II (358) 1101 model
Rod Master II (355) 1099 model
Dual Rod Holder (247) 1116 model

Mounts
Tilt-up Mounting Bracket (1023)

Swivel Mount (1026)
(except 1099 model)

Right Angle Marinco®
Receptacle Mount (2128)

Auto Stop (1121)

4 Auto Stop Beads

Weight Storage
Storage Hook (1148)
(1106B & 1116 only)

Power Source
Marinco® 12V Plug &
Receptacle (2125)

Power cord length, 40"

Downrigger Cable/Line
250 ft. of 150 lb. test stainless
steel cable. 300 ft. of 200 lb. test
braided line (1106B model only)

Counter
Mechanical (1145)

Factory & Field Tested

Fully Assembled

Warranty
Limited Lifetime

10

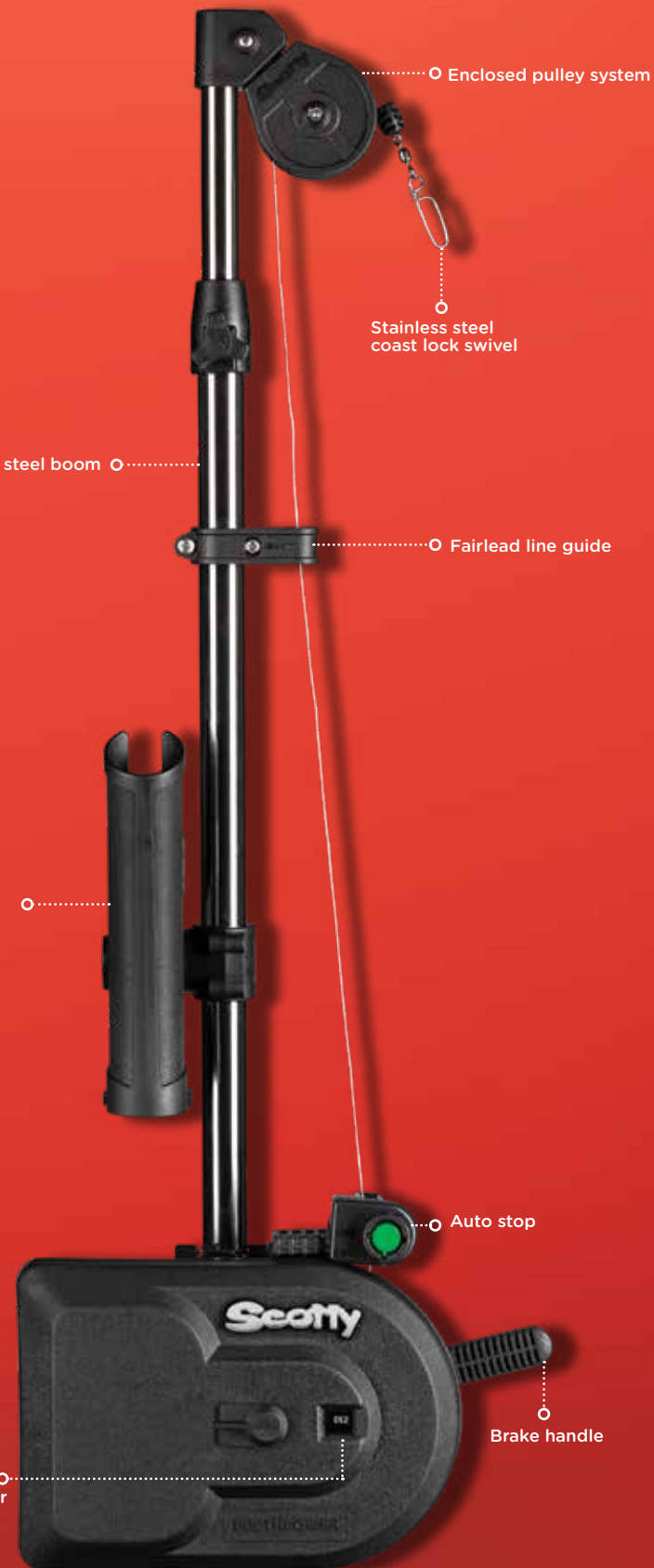

1099 | compact

All the performance features in an easy to stow compact size. Equipped with 250 ft. of 150 lb. test stainless steel cable. 24" long 1" diameter boom.



1101 | depthpower

Designed for heavy duty use, this unit will handle long hours and heavy weights in tough conditions. Equipped with 250 ft. of 150 lb. test stainless steel cable. 30" long 1 1/4" diameter boom.



1106 | depthpower

Our most popular electric Downrigger. Equipped with 250 ft. of 150 lb. test stainless steel cable. 36"-60" long 1 1/4" diameter telescopic boom.



1106 B | depthpower

All the features you have come to love with our depthpower series. Now available with more options than ever. Equipped with 300 ft. of 200 lb. test braided line. 36"-60" long 1 1/4" diameter telescopic boom.



1116 | propack

The top choice of charter captains. Equipped with 250 ft. of 150 lb. test stainless steel cable. 36"-60" long 1 1/4" diameter telescopic boom.



Protect your downrigger from the elements with our downrigger protective cover.

3015 | downrigger cover











11

MANUAL | downrigger

highest performance and reliability

Scotty Manual Downriggers have been the preferred choice of anglers for over forty years. They are engineered with a number of exclusive features contained in no other Downrigger.

FEATURES INCLUDED WITH MANUAL MODELS

-  **Line Release**
Power Grip Plus 18" (1170)
-  **Rod Holder**
Rod Master II (358)
-  **Mounts**
Tilt-up Mounting Bracket (1023)
-  **Downrigger Cable/Line**
200 ft. of 150 lb. test stainless steel cable
-  **Counter**
Mechanical (1146)
-  **Factory & Field Tested**
-  **Fully Assembled**
-  **Warranty**
Limited Lifetime



1080 | strongarm

This Downrigger has outstanding features for small and intermediate size boats. Equipped with 200 ft. of 150 lb. test stainless steel cable. 24" long 1" diameter boom.

1085 | strongarm

The heavy duty workhorse of the Scotty manual lineup. Excellent for the intermediate size boat. Equipped with 200 ft. of 150 lb. test stainless steel cable. 30" long 1 1/4" diameter boom.

1091 | longarm

Ideal for big boats. Equipped with 200 ft. of 150 lb. test stainless steel cable. 36-60" long 1 1/4" diameter telescopic boom. Includes 1026 Swivel Mount.



COMPACT downrigger

more value than anything else on the market

The Depthmaster and Depthking models offer more value for the anglers than anything else on the market. The price and operating features of these units beat the competition hands down.

FEATURES INCLUDED WITH COMPACT MODELS

Line Release
Power Grip Plus 18" (1170)

23" Long, 3/4" diameter
Stainless steel boom

Rod Holder
Rod Master II (358)

Mounts
Quick Slide Deck Mount (1010)

Downrigger Cable/Line
200 ft. of 150 lb. test
stainless steel cable

Counter
Mechanical (1146)

Factory & Field Tested

Fully Assembled

Warranty
Limited Lifetime



1050 | depthmaster

The perfect introductory Downrigger. One foot per turn of the spool. 23" long, 3/4" diameter boom.

1050MP | masterpack 1060 | depthking

The perfect clamp on Downrigger. 23" long, 3/4" diameter boom. Includes 1021 portable anodized aluminum clamp mount.

Ideal for the small boat that fishes deep and needs a high speed retrieval. Includes a high speed 2 ft. per turn of the spool. 23" long, 3/4" diameter boom.







LAKETROLLER | downrigger

light weight compact and easy to use

Laketroller Downriggers built for the smaller boat. Great for aluminum boats, kayaks and canoes.

FEATURES INCLUDED WITH LAKETROLLER

-  **Line Release**
Mini Power Grip Plus 18" (1181)
-  **Downrigger Cable/Line**
100 ft. of 150 lb. test stainless steel cable
-  **Factory & Field Tested**
-  **Fully Assembled**
-  **Warranty**
Limited Lifetime

1071 | clamp mount

Comes with fully portable engineering grade modified nylon clamp for mounting on the gunnel or transom (2" opening) Great for aluminum boats and canoes. 1 ft. per turn of the spool.



1073 | bracket mount

Mounting bracket permits mounting on a flat deck surface or on the side of a gunnel or transom. The mounting design gives 360° of rotation. Comes with a 241 Side Deck mount. 1 ft. per turn of the spool.

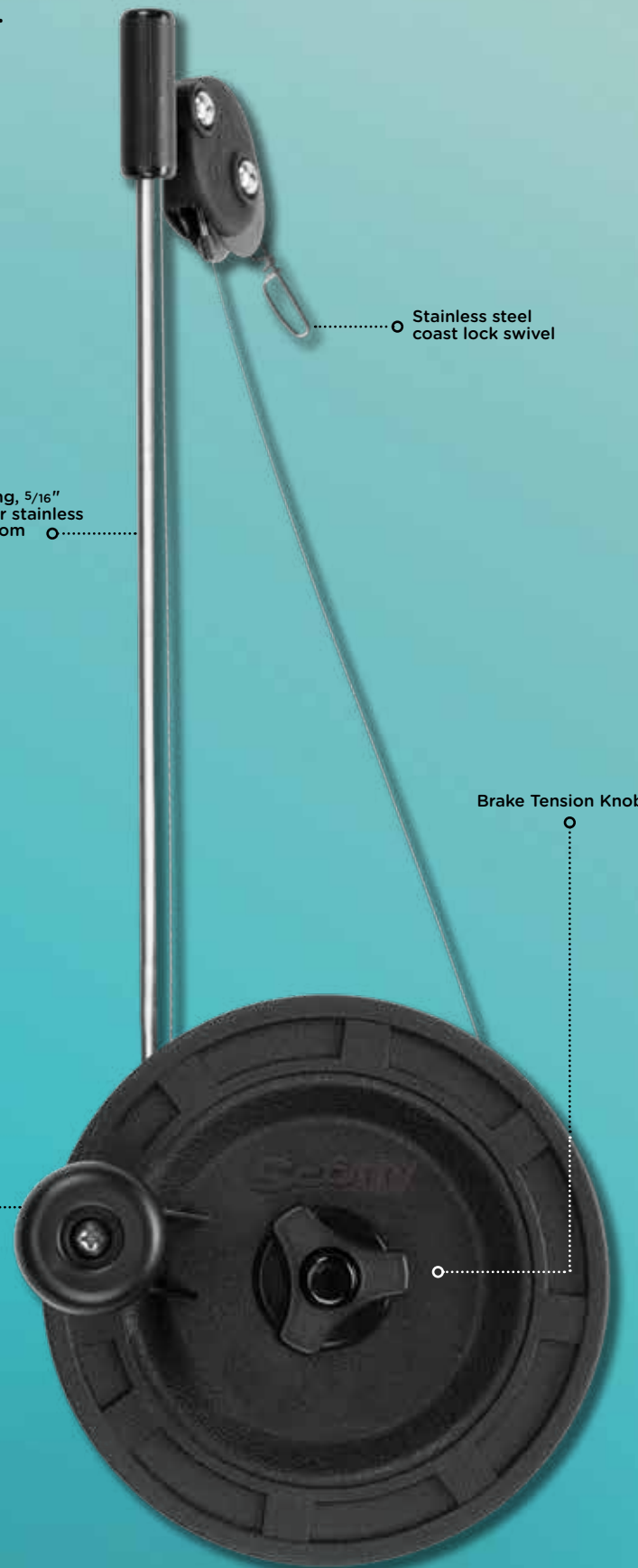

DOWNRIGGER | mounts



1027 RAIL MOUNT
Fits up to 1 1/2" round rails, including oval-shaped wooden rails. Transfers the downward pressure to the boat gunnel. Fits all Scotty Downriggers (except Laketrollers) and can be used with 1026 Swivel Mount.
Dimensions: 6 1/8" x 7 1/8"



1036 MOUNTING PLATE
Extra mounting plate for 1026 Swivel Mount and 2606/2612 Pedestal Risers.
Dimensions: 5 1/2" x 5 1/2"
Bolting dimensions: 4 1/2" x 3 1/2"



1037 MOUNTING PLATE
Extra mounting plate for 1025 Right Angle Side Gunnel Mount.
Bolting dimensions: 2" x 4" (side plate)



2027 STANCHION MOUNT
The Scotty Stanchion Mount enables you to quickly mount a Downrigger to your boat's railing stanchion for extra stability. Fits all Scotty Downriggers (except Laketrollers) and can be used with 1026 Swivel Mount.
Dimensions: 6" x 6" x 6" (top plate)
Bolting Dimensions: 2" x 4" (side plate)



1028/1029 GIMBAL MOUNT - 9"
GIMBAL MOUNT - 12"
Made from welded stainless steel for strength and durability. For use in factory mounted gimbal rod holders only. Fits all Scotty Downriggers (except Laketrollers) and can be used with 1026 Swivel Mount.
Dimensions: 1028 6 1/8" x 7 1/8" (top plate) 9" x 1 1/2" dia. (gimbal)
1029 6 1/8" x 7 1/8" (top plate) 12" x 1 3/4" dia. (gimbal)



2606/2612 PEDESTAL RISER - 6"
PEDESTAL RISER - 12"
Made from 2" stainless steel tubing for the ultimate in strength and durability. Designed to be used with 1026 Swivel Mount, 1023 tilt-up Downrigger mount and 1010 compact Downrigger mount.
Plate Dimensions: 5 1/2" x 5 1/2"
Bolting Dimensions: 3 1/2" x 4 1/2"



1023 TILT-UP MOUNTING BRACKET
Extra mounting bracket for all Scotty tilt-up Downriggers. Also used as the mounting bracket for the Scotty 2500 Line Puller.
Dimensions: 2 1/2" x 4 1/2"
Bolting dimensions: 3 3/4" x 1 5/8"



1025 RIGHT ANGLE SIDE GUNNEL MOUNT
For boats with narrow or uneven gunnels. Fits all Scotty Downriggers (except Laketrollers) and can be used with 1026 Swivel Mount.
Dimensions: 6" x 6" x 6" (top plate)
Bolting dimensions: 2" x 4" (side plate)



1026 SWIVEL MOUNT
Gives a full 360° of rotation with 16 locking positions. Comes with 1036 Mounting Plate.
Fits all Scotty Downriggers (except Laketrollers).
Dimensions: 5 1/2" x 5 1/2" x 4"
Bolting dimensions: 3 1/2" x 4 1/2"

DOWNRIGGER | compact mounts



1021 PORTABLE CLAMP-ON BRACKET
Portable mounting option. Great for aluminum boats. Double stainless steel bolts and black anodized aluminum. 2" clamp opening. To be used with 1010 mounting bracket (sold separately).
Dimensions: 5 5/8" x 4 3/4" x 3 1/8"



1010 QUICK-SLIDE DECK MOUNTING BRACKET
Works with the 1025 through 1029 optional mounts.
Dimensions: 4 3/4" x 5 5/8"
Bolting Dimensions: 2 5/8" x 4 7/8"

DOWNRIGGER | dual rod holder



247 DUAL ROD HOLDER
For use with the 1026 Swivel Mount.



447 DUAL ROCKET LAUNCHER ROD HOLDER
For use with 1026 Swivel Mount.



DOWNRIGGER | parts & accessories



1132
EMERGENCY CRANK HANDLE
(For Electric Downriggers)



1147
DOWNRIGGER WEIGHT HOOK
For 1" boom

1148
DOWNRIGGER WEIGHT HOOK
For 1 1/4" boom



1014
DOWNRIGGER PULLEY
REPLACEMENT KIT



SPARE DRIVE BELTS

1128
For 2 belt Depthpower Downriggers,
2000 models and earlier, dual belt model

1129
For 1 belt Depthpower Downriggers,
2001 models and later

2129
For High Performance Downriggers
and Line Puller (2500)

1035
1 3/4" REPLACEMENT
MOUNTING BOLTS (2 pcs)

1135
2 1/4" REPLACEMENT
MOUNTING BOLTS (2 pcs)

1034
4 1/2" DOWNRIGGER MOUNTING
BOLT (2000 models and earlier)

1134
6" DOWNRIGGER/LINE PULLER
MOUNTING BOLT (2001 Downrigger
models and later)



1139
DOWNRIGGER PULLEY UPGRADE



1017
DOWNRIGGER LEAD WEIGHT
3 lb. finned



1142
MANUAL DOWNRIGGER HANDLE



1158
DEPTHPOWER DOWNRIGGER
SPARE PARTS KIT

1159
HIGH PERFORMANCE DOWNRIGGER
SPARE PARTS KIT



3134
DOWNRIGGER LOCKING PLATES
For electric or manual downriggers (3 pcs)
(locks sold separately)



3022
WEIGHT MATE Holds your Downrigger
weights securely (2 pcs)



1146
MANUAL COUNTER WITH BASE



1145
DEPTHPOWER COUNTER
WITH BASE



2134
HIGH PERFORMANCE DIGITAL
COUNTER (replaceable AAA Battery)



1024
MANUAL COUNTER COVER



1131
DEPTHPOWER REPLACEMENT LID



2133
HIGH PERFORMANCE REPLACEMENT
LID WITH DIGITAL COUNTER

POWER | accessories



1125
HELLA® 12V DOWNRIGGER PLUG &
SOCKET SET Maximum 12 volt 18 amp
applications (1126 & 1127)

1126
HELLA® 12V DOWNRIGGER SOCKET
1127
HELLA® 12V DOWNRIGGER PLUG



1133
PREMIUM TINNED COPPER 12 GAUGE
2 CONDUCTOR POWER WIRE (12 ft.)



1124
30 AMP MARINE IN-LINE
FUSE HOLDER (Fuse included)



2127
MARINCO® 12V DOWNRIGGER PLUG



2126
MARINCO® 12V DOWNRIGGER
RECEPTACLE
2125
MARINCO® 12V DOWNRIGGER PLUG
AND RECEPTACLE SET (2127 & 2126)

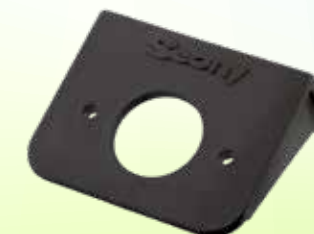

2128
RIGHT ANGLE RECEPTACLE MOUNT
For Marinco® Downrigger Receptacle

DOWNRIGGER tackle



1157
STAINLESS
STEEL
THIMBLE
SET (2 pcs)

1007
RELEASE CLIP
LOCATORS
(10 pcs)

2008 (6 pcs)
2008-24 (24 pcs)
AUTO STOP
BEADS
For braided line.

1150
225 LB.
TEST
COASTLOCK
SNAPS
(2 pcs)

1011
DOUBLE LINE
CONNECTOR
SLEEVES
(10 pcs)

1039
SOFT STOP
BUMPERS
For snap hooks
(4 pcs)

1008 (6 pcs)
1008-24 (24 pcs)
AUTO STOP
BEADS
For stainless steel line.

1004
CONNECTOR
SLEEVES
(10 pcs)

1151
350 LB. TEST COASTLOCK SNAP
WITH SAMPO® SWIVEL

1152
350 LB. TEST LARGE
COASTLOCK SNAPS

1153
350 LB. TEST COASTLOCK SNAP
TERMINAL TACKLE

1154
INSULATING DOWNRIGGER
WEIGHT SWIVEL HOOKS WITH
TERMINAL TACKLE

1009
INSULATING DOWNRIGGER
WEIGHT SWIVEL HOOKS

1038
CABLE COUPLER

DOWNRIGGER cable & line

1000 stainless
steel cable
150 lb test

1000
200 ft.

1001
300 ft.

1002
400 ft.



2200 heavy duty
braided line
250 lb test

2200K
200 ft. with
terminal tackle

2201K
300 ft. with
terminal tackle

2202K
400 ft. with
terminal tackle

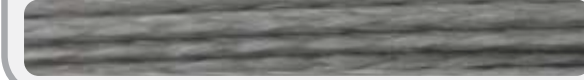

1000K stainless
steel cable
150 lb test

1000K
200 ft. with
terminal tackle

1001K
300 ft. with
terminal tackle

1002K
400 ft. with
terminal tackle



2700 premium
braided line
200 lb test

2700K
200 ft. with
terminal tackle

2701K
300 ft. with
terminal tackle

2702K
400 ft. with
terminal tackle



2400 hp stainless
steel cable
180 lb test

2401K
300 ft. with
terminal tackle

2402K
400 ft. with
terminal tackle

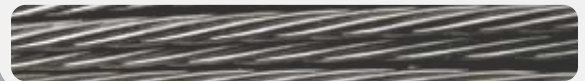

2800 low drag
braided line
150 lb test

2800K
200 ft. with
terminal tackle

2801K
300 ft. with
terminal tackle

2802K
400 ft. with
terminal tackle



DOWNRIGGER | snubbers & more



3025

371

370

1156/1155

374

1161

373

375/376

377/378

3025 DOWNRIGGER WEIGHT RETRIEVER

370 TROLLING SNUBBER
with Ball bearing swivel and Self Locating Snap

371 TROLLING SNUBBER
with Self Locating Snap

1156 3" SELF LOCATING SNAP
Stainless steel (2 pcs)

1155 5" SELF LOCATING SNAP
Stainless steel (2 pcs)

374 SURE STOP ELECTRIC DOWNRIGGER STOPPER SYSTEM
For 30 & 60" Downrigger booms

1161 DUMMY FLASHER RIG (2 pcs)

373 DIVER SNUBBER (2 pcs)

375 SURE STOP PRO for 30" boom

376 SURE STOP PRO for 60" boom

377 SURE STOP PRO for 30" boom with Snubber

378 SURE STOP PRO for 60" boom with Snubber

3025 | downrigger weight retriever

A safety precaution for the Downrigger angler. Brings your weight in for rigging lines and releases without having to lean out over the water. Snubber sold with models 377 and 378.



375-378 | SURE STOP PRO FOR ELECTRIC DOWNRIGGERS

The sure stop turns off your electric Downrigger's auto stop at the same spot every time. The tuna cord provides a secure hold for your self-locating snap and is easier on your hands when pulling your gear to the boat. The Scotty Snubber absorbs shock, provides electrical insulation and helps prevent snags (models 377 & 378). Tubing has been added to provide protection against abrasion in high wear areas.



POWER GRIP PLUS | line release

won't snag on weeds or foul lines



1. Attach to your Downrigger Cable or Cannonball.
2. Attach your fishing line to the Power Grip release by squeezing the jaws apart and placing your fishing line between the pads. The release tension is lighter at the outer tip, and is heavier the further into the jaws you place the line.
3. The tension adjuster can be moved forward to decrease or back to increase the release tension.



1171



1170

POWER GRIP PLUS

1170 18"
Monofilament leader with Cannonball Snap

1171 18"
1172 30"
1173 48"
1178 60"
Monofilament leader with Self Locating Snap

1176 6"
1179 30"
1191 48"
1192 60"
Stacker with monofilament leader and Cannonball Snap

1177 Planer Board Snap
1190 Power Grip Plus pads (6 pcs)

MINI POWER GRIP PLUS

1181 18"
Wire leader with Cannonball Snap

1180 18"
1183 30"
Wire leader with Self Locating Snap

1182
Planer Board Snap (4 pcs)



1180



1182



1176



1177



1181



1183



1190

SNAPPER | line release

Fishing line is gripped between the soft pads. Variable release tension is attained by moving the line in or out of the jaws.



1160 6"
SNAPPER RELEASE CLIP
Stacker with monofilament leader and Cannonball Snap



1041 18"
1049 30"
1040 48"
SNAPPER RELEASE CLIP
Monofilament leader with Self Locating Snap



1042 18"
SNAPPER RELEASE CLIP
Monofilament leader with Cannonball Snap

MINI SNAPPER | line release



1046 18"
MINI SNAPPER RELEASE CLIP
Monofilament leader with Self Locating Snap









1047 18"
MINI SNAPPER RELEASE CLIP
Monofilament leader with Cannonball Snap

LINE puller

crab & prawn trap pulling power

High torque 12V motor pulls 1 crab trap or 4 prawn traps. 120 fpm retrieval speed. Accommodates 1/4"–3/8" line. Compact size makes for easy stowing. Heavy duty stainless steel and composite construction. Easy access on/off switch. For recreational use only.

FEATURES INCLUDED WITH LINE PULLER

-  **Mounts**
Non-tilting Mounting Bracket
-  **Power Source**
Marinco® 12V Plug & Receptacle (2125)
-  **Power Cord**
Length 40"
-  **Amperage Power**
19 amp draw at 50 lbs.
-  **Factory & Field Tested**
-  **Fully Assembled**
-  **Warranty**
2 year



Pivoting pulley ○

Stainless steel boom ○

Easy wrap capstan ○

On/off switch ○

TRAP-EASE

Crab and prawn trap roller for easy retrieval. Fits all Scotty post mounts.



749
TRAP-EASE No mount.



750
TRAP-EASE 241 Side Deck Mount.



2515
LINE PULLER STOW-AWAY BAG
This durable stow-away bag protects your Scotty Line Puller from the elements when not in use.



BAIT jars

Quick lock threaded lid

Vented lid for optimal scent release but prevents sea lice entry.

652
Fluorescent red 1/2 L bait jar

651
White 1 L bait jar

671
White 1 L vented bait jar

657
Fluorescent red 1 L bait jar

650
White 1/2 L bait jar

677
Fluorescent red 1 L vented bait jar

672
Fluorescent red 1/2 L vented bait jar

670
White 1/2 L vented bait jar

R-5

universal rod holder

the newest to the Scotty family

NEW FOR 2021

The R-5 Rod Holder has been designed to securely hold your, Spinning, Baitcaster, Level Wind, Spincaster and Fly Rods with up to 15 lb test line. The adjustable 1/4" stainless steel lock bar pivots open to allow a quick effortless release of your rod.

Fully adjustable lock bar tension adjusted with two number ten screws.

Designed and backed by the Scotty name.



▲ SPINCASTER REEL



▲ FLY REEL



▲ LEVEL WIND REEL

▼ BAITCASTER REEL

▼ SPINNING REEL

LOCK BAR IN OPEN POSITION



30



289
No mount.



290
241 Side Deck Mount.



31

ORCA

rod holder

setting the hook is perfected

The inner sleeve opens in one smooth motion allowing your rod to be released in an instant. With one quick motion, your fishing rod is lifted straight out into the fish fighting position.

Large cradle design fits big reels

Upward motion opens rod holder

Transport lock tab

7 Locking angle positions

11 locking Position 360° post mount

1 7/8" ID accommodates large rods



400
241 L Locking Side Deck Mount.



401
244L Locking Flush Deck Mount.



405
459 Double Ended Extender.



SMOOTH EASY OPEN ACTION



LOCKING TAB TO PREVENT ROD LOSS WHILE TRAVELING

All post mount Scotty Rod Holders are fully adjustable and interchangeable.

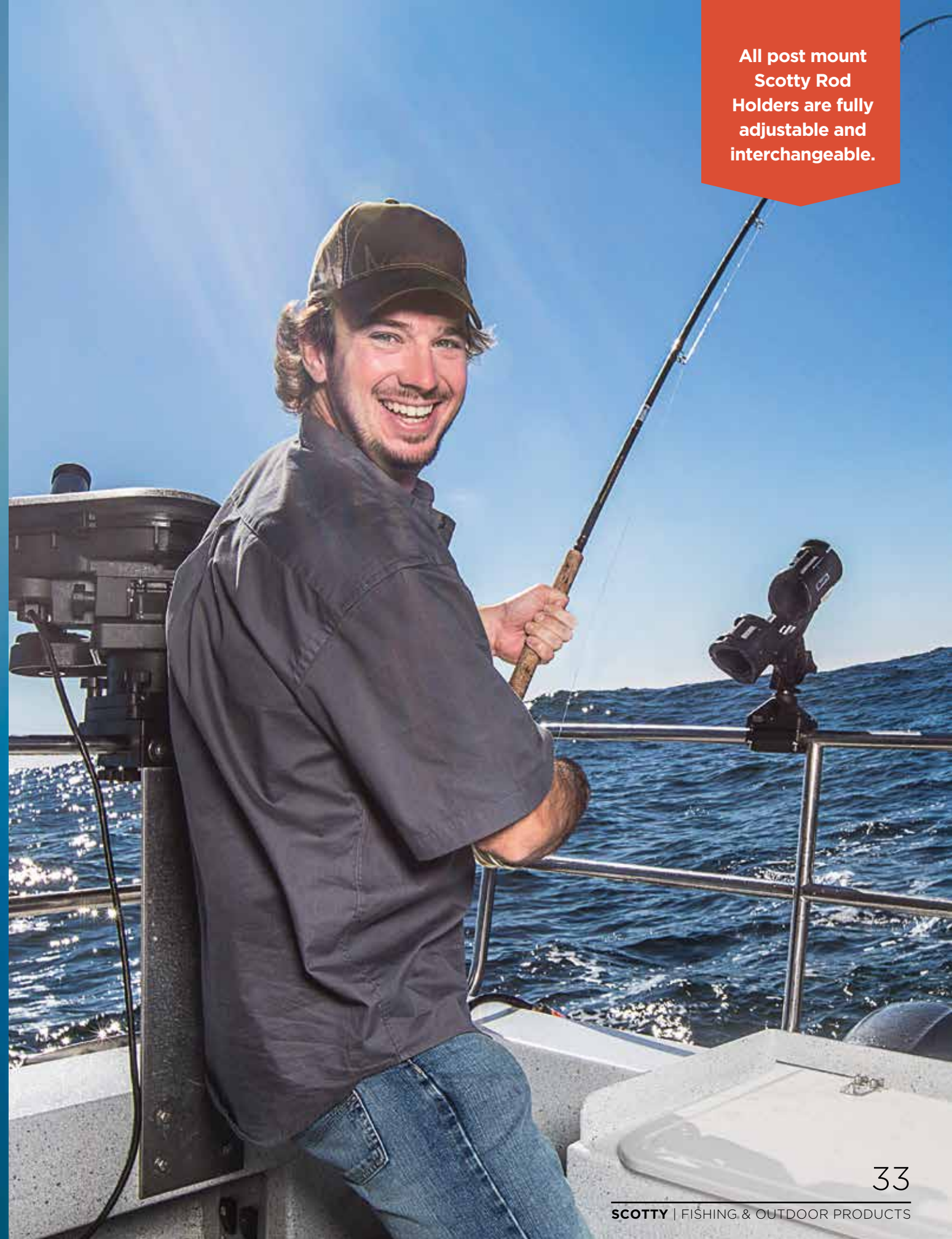

STRIKER rod holder

designed for big game fish

Designed and built tough for Salmon, Muskie, Halibut, Sturgeon, and other big game fish. Stainless steel reinforced post with an oversized opening and easy lock/unlock collar. The inner support rotates with the rod to instantly remove and strike simultaneously.



239
No mount.

LOCKING COLLAR



240
241 Side Deck Mount.

Striker outfitted with
423 adaptor, 1023
Tilt up mounting
bracket and 1026
Swivel mount.

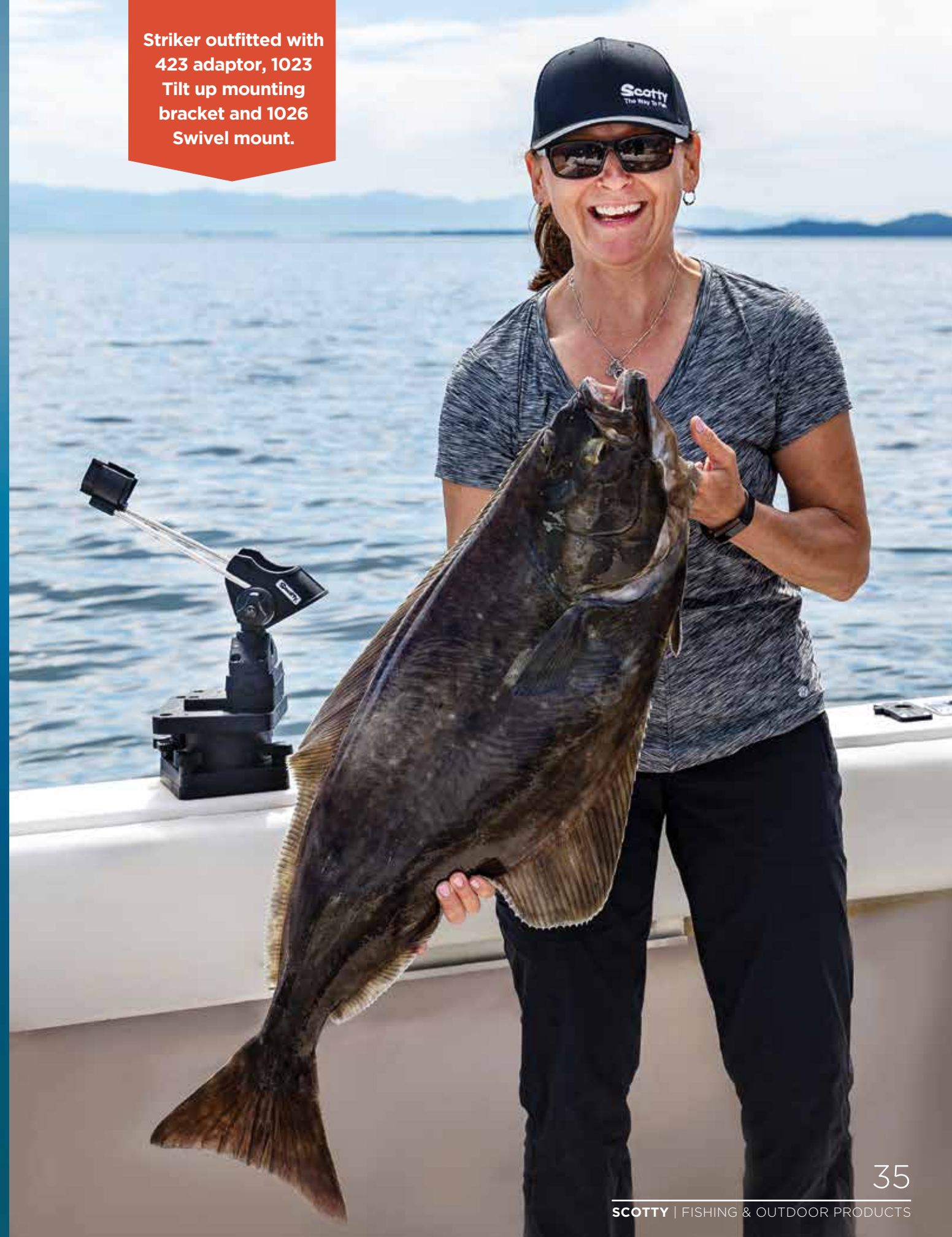

POWERLOCK | rod holder

our most popular rod holder

Universal cradle holds almost any reel type. Fibre reinforced engineering grade nylon provides strength, resilience and reliability.



230
241 Side Deck Mount.
○○●



231
244 Flush Deck Mount.



229
No mount.

LOCKING COLLAR



UNLOCKED



LOCKED



256
Triple with 257 and 241 Mounts.



339
449 Clamp and 241 Mount (maximum clamp opening 2").





ROD HOLDERS

rocket launcher

10" tube style holder with front end reel slot and removable gimbal pin accommodating any rod and reel combination. Fibre reinforced engineering grade nylon offers strength, resilience and reliability. All post mount Scotty Rod Holders are fully adjustable up and down and with 360° of horizontal rotation. Rocket Launcher Interior Diameter: 1.7"



479
Comes with no mount, enabling you to choose whichever mount suits your needs separately.



476
Includes 241 Combination Side Deck Mount and can be mounted on top or side of gunnel.

rod master

Original 8" tube style holder accommodates any rod and reel combination including large rod butt tips. Fibre reinforced engineering grade nylon offers strength, resilience and reliability. All post mount Scotty Rod Holders are fully adjustable up and down and with 360° of horizontal rotation. Rodmaster Interior Diameter: 2 1/8"



250
241 Side Deck Mount

stainless steel rocket launcher

Tube style Rod Holder with 9" of heavy duty stainless steel jacketed composite construction. Fibre reinforced engineering grade nylon offers strength, resilience and reliability. All post mount Scotty Rod Holders are fully adjustable up and down and with 360° of horizontal rotation. Accommodates a wide range of rod and reel setups. Rocket Launcher Interior Diameter: 1.7"



469
Comes with no mount, enabling you to choose whichever mount suits your needs separately.



470
Includes 241 Combination Side Deck Mount and can be mounted on top or side of gunnel.

side winder

This Rod Holder was designed for fast and instant rod removal. Complete with 5/16" stainless steel for strength and durability. Soft grips protect your rod and this classic design is a favourite among anglers.



222
5/16" stainless steel construction. 237 Triggerlock Mount Included.



223
no mount (not shown)

rod master II

10" tube style holder with front end reel slot and removable gimbal pin accommodating any rod and reel combination. Fibre reinforced engineering grade nylon offers strength, resilience and reliability. All post mount Scotty Rod Holders are fully adjustable up and down and with 360° of horizontal rotation. Rodmaster II Interior Diameter: 1.85"



349
No mount.



350
241 Side Deck Mount.



351
244 Flush Deck Mount.



358
Fits 1 1/4" Scotty Downrigger boom.



355
Fits 3/4" and 1" Scotty Downrigger booms.

Blainey Scott's original Rod Holder. The Side Winder has stood the test of time and is still a classic #1 choice.

BAITCASTER SPINNING

rod holder

best selling rod holder

Holds a baitcaster reel securely in the cushioned cradle. A slot in the front of the rod holder allows for secure holding of a spinning reel. This rod holder is designed with a side mounted flange which leaves the bottom open, this allows for the rod holder to accommodate trigger grips. Rods can be secured with a soft latching strap which snaps over the top for baitcaster or under the bottom for spinning reels.



284
243 1/4" Square Rail Mount.



282
438 Gear Head and 440-4 Track.



389
449 Clamp and 241 Mounts.
Maximum clamp opening 2".



388
429 Gear Head Mount Extender and 241 Mount.



279
No mount.



280
241 Side Deck Mount.



281
244 Flush Deck Mount.

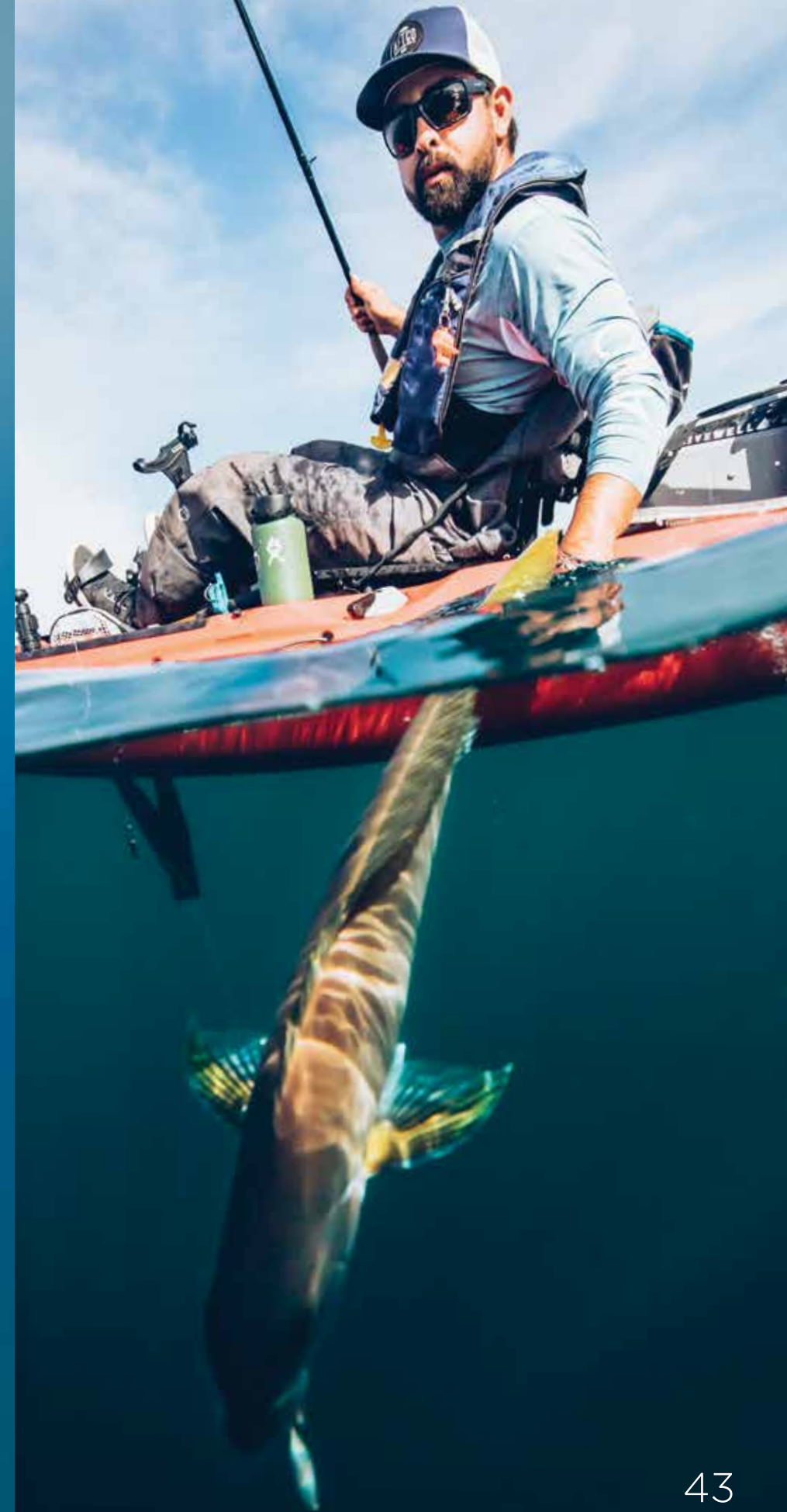

FLY ROD

rod holder

secure holding of your fly rod

Innovative compact design allows for hands free trolling with a Fly Rod. Your rod can be secured in the rod holder with the soft latching strap which snaps over the top. Works well with "short butt" fly rods. All post mount Scotty Rod Holders are fully adjustable.



260
No mount.



264
244 Flush Deck Mount.



267
241 and 266 Float Tube Mounts.



265
241 Side Deck Mount.

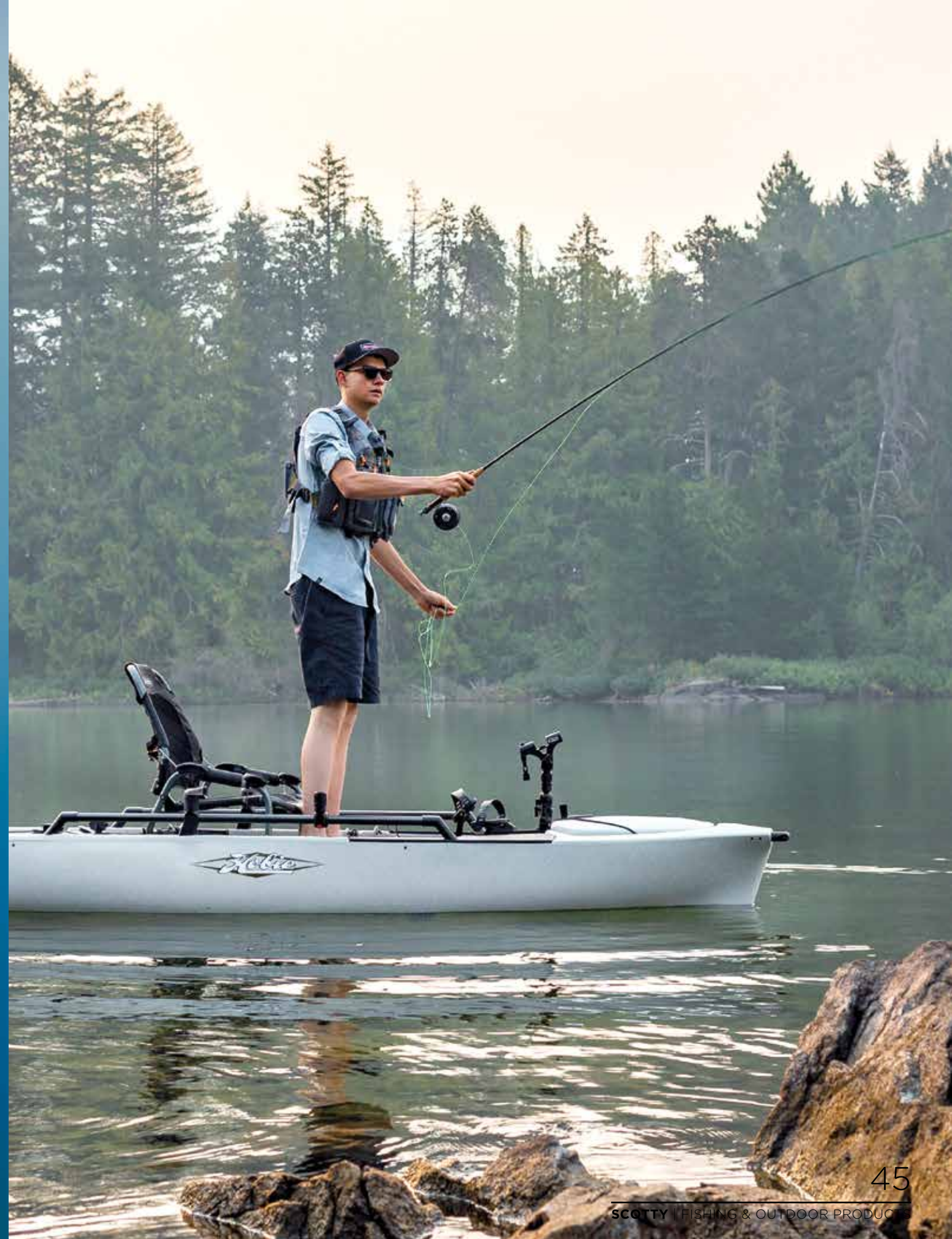

ELECTRONIC mounts

secure your fish finder

Mounting your fish finder has never been easier with our universal fish finder mount. Designed with a multi pattern top plate to fit most popular electronic brands. The perfect mount for your 7" - 9" screens. The post mount allows you to install your screen in any of our Scotty post mount brackets. A full 360° of rotation allows you to position your screen in the perfect spot every time. Engineering grade nylon and stainless steel fasteners guarantee a lifetime of use even in the toughest conditions. Some assembly required. Accessories sold separately.



367 universal

sounder fish finder mount



368
UNIVERSAL SOUNDER FISH FINDER MOUNT
This uses a multi pattern universal top plate and the post mount design for quick removal and adjustable rotation.



268
FLOAT TUBE FISH FINDER MOUNT
Adapt a fish finder to your float tube or pontoon boat. Includes transducer bracket and 6' strap.



367
UNIVERSAL SOUNDER FISH FINDER MOUNT
The perfect mount for your 7"-9" screens.



272
SWIVEL FISH FINDER MOUNT
Mount only.



269
SWIVEL FISH FINDER MOUNT
241 Side Deck Mount.

Pair your electronics with the strongest mounts on the market. All of our products are made under one roof. This gives us the ability to produce the highest quality you have come to trust.



TRANSDUCER

mount

Designed for kayaks and small boats

Made from high strength composite materials. Adjustable arms allow for multiple depths and angles. Collapses easily for storage. 415 slip discs for micro adjustments.



140
TRANSDUCER ARM
412 Post and 241 Side Deck Mount.

141
TRANSDUCER ARM
438 Gear Head and 440-4" Low Profile Track.

CAMERA

mount

full rotation



135
CAMERA MOUNT
This mount is fully twistable, turnable, rotatable and best of all, instantly portable. Locks down a sport or standard camera without needing a special adaptor. Also included is a rail mount.

BALL mounts

a system designed for full range of motion

The ball mounting system design enables a smooth, full range of motion. The corrosion proof construction provides a long service life in both fresh and salt water applications.



158
1" BALL ACCESSORY
Adapt your Scotty low profile track to our 1" ball mounting system.



168
1.5" BALL ACCESSORY
Adapt your Scotty low profile track to our 1.5" ball mounting system.



150
1" BALL MOUNT
Universal Mounting Plate.



159
1" BALL ACCESSORY
Adapt your Scotty post mount to our 1" ball mounting system.



169
1.5" BALL ACCESSORY
Adapt your Scotty post mount to our 1.5" ball mounting system.



151
1" BALL MOUNT
Gear Head & track.



162
1.5" BALL MOUNT
Gear Head, post & Side Deck Mount.



163
1.5" BALL MOUNT
Fish Finder & Universal Mounting Plate designed for use with 7-9" screens.



152
1" BALL MOUNT
Gear Head, post & Side Deck Mount.

Ball mounting system

173 | 2.25" ball mount

for large fish finders

Arrange your fish finder at the perfect angle on your watercraft with this heavy duty 2.25" ball mount. Designed for 10"- 12" fish finders. Pre fabricated holes on the top plate allow easy installation of your gimbal mount bracket. The square base securely fastens with 1/4" bolts. 2.25" ball design has superior strength and reliable holding power. Constructed using engineering grade Nylon and stainless steel fasteners to last a lifetime.



2.25" High grip ball

Mounting plate for 10"-12" Fish Finders

Large easy to handle T-knob

Corrosion proof reinforced nylon

3.25" square fixed mount

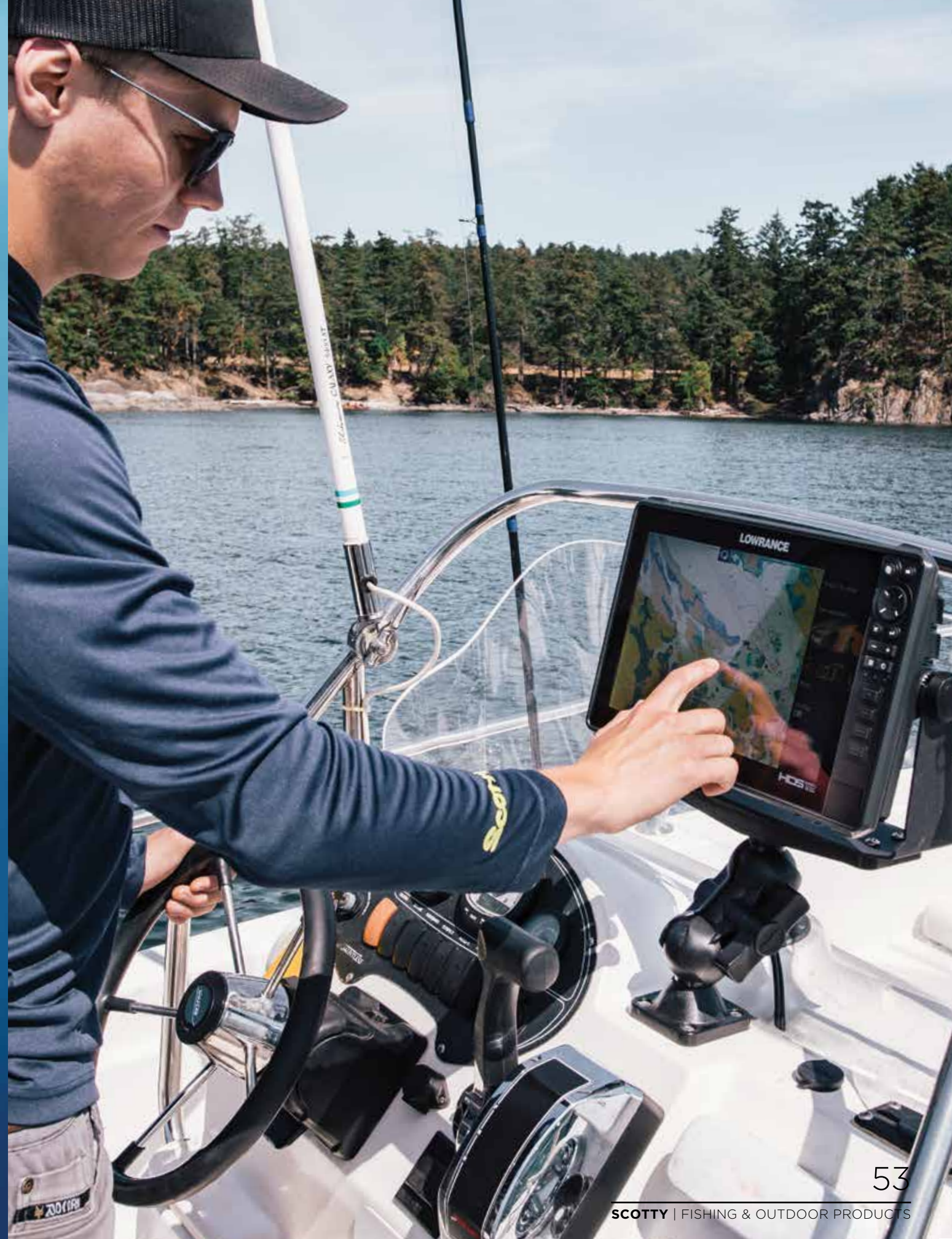



241
SIDE DECK MOUNT
Can be mounted on top or side of your gunnel.
○○●



241L
LOCKING SIDE DECK MOUNT
A 241 mount with an easy to use lock and unlock push button system.



344
ROUND FLUSH DECK MOUNT
Sealed base for watertight applications.



444
COMPACT THREADED DECK MOUNT
Use on gunnels up to 2" thick. Base cap for watertight applications.



244
FLUSH DECK MOUNT
Sealed base for watertight applications.



244L
LOCKING FLUSH DECK MOUNT
Locks and unlocks your post mount product easily by sliding a lever.



243
SQUARE RAIL MOUNT
Fits 1 1/4" rail.



245
ROUND RAIL MOUNT
Fits 1 1/4" rail.



287
ROUND RAIL MOUNT
Fits 7/8" rail.



248
OARLOCK MOUNT
Use the oarlock mount on your row boat to mount any Scotty post mount rod holder or accessory.



449
CLAMP MOUNT
Fully portable mounting option for all Scotty post mount rod holders and accessories, maximum clamp opening 2".



433
COAMING/GUNNEL CLAMP MOUNT
Position your rod holder or accessory virtually anywhere on the lip of your kayaks coaming or boat gunnel, maximum clamp opening 1 1/2".

adaptors



237
TRIGGERLOCK
Designed for 222 Sidewinder Rod Holder.



238
RAIL MOUNT ADAPTOR
Works in conjunction with 237 Triggerlock Mount (7/8" and 1" round rails).



441
BACKING PLATE
Adds structural support when attaching a Side Deck or Flush Deck Mount to a thin-walled watercraft.



242
RAIL MOUNT ADAPTOR
Works with 241 Side Deck Mount (7/8" and 1" round rails).



340
TRACK ADAPTOR
Convert your 3 1/2" track into a Scotty Post Mount. 241 Side Deck Mount required.



423
DOWNRIGGER ROD HOLDER ADAPTOR
Convert your 1023 tilt-up mounting bracket into a rod holder mount. 241 Side Deck Mount required.

TRIPLE mounting systems

Designed to be a multi-functional rod holder or accessory platform for any watercraft.



257
TRIPLE MOUNT
241 Side Deck Mount.



362
TRIPLE MOUNT
Fixed Mount.





the way to fish

LOW PROFILE track

top load design for quick and easy use

Made from corrosion proof high strength composite materials that will last a lifetime. Use the 438 Gear Head Track Adaptor to mount all of your favourite rod holders and accessories.

440-1 
1" LOW PROFILE TRACK
 Dimensions: 7" L x 1 3/4" W x 3/8" H
 Bolting Dimensions: 1 3/4" x 1 1/8"

440-4 
4" LOW PROFILE TRACK
 Dimensions: 3 1/2" L x 1 3/4" W x 3/8" H
 Bolting Dimensions: 1 3/4" x 1 1/8"

440-8 
8" LOW PROFILE TRACK
 Dimensions: 10 3/4" L x 1 3/4" W x 3/8" H
 Bolting Dimensions: 1 3/4" x 1 1/8"



311 CUP HOLDER • 438 GEAR HEAD • 440-1 TRACK



290 R-5 ROD HOLDER • 438 GEAR HEAD • 440-4 TRACK

GEAR head

track adaptor & mounts

Quick and easy, drop and lock system. Allows you to secure and reposition your rod holder or accessory with just a twist. Fits all Scotty post mount rod holders and accessories.

426
SIDE SLIDE TRACK ADAPTOR
 Our unique Track Adaptor allows you to securely fasten your favourite post mount product to a side mounted track.



428
GEAR HEAD MOUNT
 Use in conjunction with any of our height extenders to bring your rod or accessory closer to you.



438
GEAR HEAD TRACK ADAPTOR
 Use the Track Adaptor with the 440 Low Profile Track for quick and easy installation and removal of your favourite Scotty post mount product.



436
STAND UP PADDLE BOARD LEASH PLUG ADAPTOR
 The adaptor attaches to your SUP pre-installed leash plug with a stainless steel J Hook. Accepts all post mount rod holders and accessories.



135 CAMERA MOUNT • 438 GEAR HEAD • 440-8 TRACK

279 BAITCASTER • 438 GEAR HEAD • 440-8 TRACK

INFLATABLE

accessories

fishing essentials



838
Sea Light



793
Throw Bag



311
Cup Holder



279
Baitcaster
Spinning
Rod
Holder



750
Trap-ease



140
Transducer
Mount



439
Track
adaptor

438
Gear Head
Track
adaptor



290
R-5 Rod
Holder



276
Anchor Lock



443
3" Glue/stick on
Mount- Flexible
D-Ring



445
2" Glue/stick
on Mount
438 Gear
Head



130
Paddle
Leash



545K
25½" O.A.L.
Kayak
Pump



448
3" Glue/stick
on Mount
438 Gear Head



1073
Laketroller



779
Small Vessel
Safety Kit

439 track adaptor

for glue on pad

Our track adaptor allows you to mount your favourite track accessories to your inflatable watercraft's pre installed 341 mounts.

Simply fasten the track to your 341 mount with the supplied 1/4 - 20 x 1/2" stainless steel bolts. Slide and lock our 438 gear head adaptor or ball mount onto the track.



- Smooth low profile for snag free lines
- Top load design allows for easy installation
- Engineering grade fibre reinforced nylon
- 1/4- 20 x 1/2" stainless steel fasteners



279 BAITCASTER • 438 GEAR HEAD
• 439 TRACK • 341 GLUE/ON MOUNT



368 MOUNT • 438 GEAR HEAD
• 439 TRACK • 341 GLUE/ON MOUNT



368 MOUNT • 438 GEAR HEAD
• 439 TRACK • 341 GLUE/ON MOUNT



135 CAMERA MOUNT • 438 GEAR HEAD • 163 BALL MOUNT
• 439 TRACK • 341 GLUE/ON MOUNT



279 BAITCASTER • 438 GEAR HEAD • 163 BALL MOUNT
• 439 TRACK • 341 GLUE/ON MOUNT

Please note:
Only use 1/4 - 20 x 1/2" bolts when fastening the track to your 341 glue on pad.

BOATING & fishing accessories



206/207

225/226

3010

311BK

210

125

64

990

415

412

414

B

C

210
NET MINDER
A quick release and tangle free system for netting fish.

215
REPLACEMENT NET BAG
(not shown)

3010 ●●●●●●●●
Snap Hook Key Chain.

125
TUMBLER CUP
Holds up to 12 oz. dishwasher safe.

310
CUP HOLDER & BUTTONS
Cup Holder **A** and Gunnel mount **C**.

311
CUP HOLDER & BUTTONS
Cup **A**, Post **B** and Gunnel mount **C**.

990
KNIFE SHARPENER
Safe and easy to use. Comes with rotatable carbide blades.

415
SLIP DISKS
Allows you to make micro adjustments to your rod holder or any Scotty post mount products.

414
OFFSET GEARS
Doubles your rod holder positions for ultimate versatility.

412
REPLACEMENT POST
The replacement post fits all Scotty post mount rod holders.

206
ALUMINUM LANDING NET
4 ft. pole with 30" hoop.

207
6 ft. pole with 30" hoop.

225
24" GAFF

226
30" GAFF

MOUNTS | glue/stick on

includes 3M™ VHB™ Tape

3M™ VHB™ Tapes utilizes modified acrylic adhesive on both sides of a very conformable, adhesive foam core.



342
GLUE/STICK ON PADDLE CLIP

443
3" GLUE/STICK ON MOUNT
Flexible D-Ring.

448
3" GLUE/STICK ON MOUNT
438 Gear Head.

445
2" GLUE/STICK ON MOUNT
438 Gear Head.

311
GLUE ON MOUNT



All these products are ideal for inflatable watercrafts, paddle boards and kayaks.

EXTENSIONS & adaptors

Extend and adapt all of your Scotty post or spline mount rod holders and accessories. Always have your fishing rod within reach and your favourite accessories at the perfect location.

259
height extender
6½" long

254
height extender
8½" long

254M
mini extender
4¼" long

412
post

459
double ended
extender
9½" long

453
gimbal adaptor
gear head

2028
gimbal mount
1½" diameter 9" long

253
gimbal
mount

459M
mini double
ended extender
5½" long

429
gear head
mount extender

BAIT BOARD & accessory tray

135 camera mount



990 knife sharpener



310 cup holder



455 bait board & accessory tray



241 side deck mount



ANCHOR LOCK & kit



278 ANCHOR LOCK
Fixed mount.

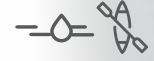

276 ANCHOR LOCK
241 Side Deck Mount.

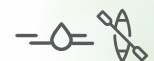

277 ANCHOR LOCK
244 Flush Deck Mount.

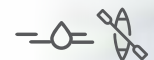

797 ANCHOR KIT
Anchor Kit for still water use only



BOATING accessories

101
OAR COLLARS
 Made from polyethylene. Quick and easy to install. 1 3/4" inside dia. can be trimmed to fit smaller oars (fasteners included).

102
STRONGBACK OARLOCKS
 2 1/2" Standard Oar.

104
STRONGBACK OARLOCKS
 1 3/4" Small Oar.

103
OARLOCK POSTS
 Adapt your post mount to a 1/2" oarlock socket.

425
ROD BUTT CUSHION
 The next best thing to a fighting belt. The Rod Butt displaces the pressure of your rod while playing fish.

327
FENDER RINGS
 Use to attach a fender to your Scotty post mounts (2 pcs).

132
EXTRA LONG GRIP MOUNTING RIVETS
 These structural rivets are an excellent solution for mounting hardware where you don't have access to the back side of a mount (10 pcs).

416
ROD BALANCER/REST
 Non-resistance approach encourages more efficient and successful strike to hook-sets when fishing.

133
WELL NUT MOUNTING KIT
 Securely fasten a multitude of products onto thin walled structures with ease. Available in 4 or 16 pack options (fasteners included).

590
SNAP HOOKS
 Our nylon clips are a perfect solution for attaching items to your watercraft (6 pcs).

300BK
TARP CLIPS
 Quick and easy to use design with powerful locking jaws for the ultimate hold (4 pcs).

301BK
TARP CLIPS BULK/BUCKET
 Our patented jaw locking feature with a quick push button release (60 pcs).



PADDLE SPORT | accessories



136 PADDLE CLIP
Permanently mount to your watercraft with 2 x #6 screws.



342 GLUE/STICK ON PADDLE CLIP
Easily clip your paddle to your inflatable watercraft with 1" x 6" PVC pad.



130 PADDLE LEASH
Secure your paddle or fishing rod.



341 GLUE-ON MOUNT
Designed to be used with our 241/241L and 439 mounts (7" x 9" pad)



436 STAND UP PADDLE BOARD LEASH PLUG ADAPTOR
The adaptor attaches to your stand up paddle board's pre-installed leash plug with a stainless steel J Hook. Accepts all post mount rod holders and accessories.



445 2" GLUE/STICK ON MOUNT
438 Gear Head.



302 | kayak stabilizer

security & stability

Feel secure and stable while fishing with Scotty Stabilizers attached to your kayak. Easily inflatable bladders offer over 30 pounds of extra buoyancy and our unique assembly system makes installation and removal a breeze. The pontoons are made from a rugged PVC with thick outer shell for extra durability.



visit page 79 for safety products

302 KAYAK STABILIZER
Over 30 lbs. of extra buoyancy. Our unique design makes installation and removal quick and easy.

CONTAINS

- 2 Inflatable Pontoons
- 2 Anodized Aluminum Stabilizer Arms (28")
- 2 Baitcaster Spinning Rod Holders (279)
- 4 Locking Side Deck Mounts (241L)

- Stabilizer Arm Length:** 28"
- Inflatable Pontoon Length:** 30"
- Inflatable Pontoon Diameter:** 8"
- Zipper Opening:** 30" long x 8" diameter



Not recommended for surf launching or use in extreme conditions.



282
Baitcaster spinning rod holder



429
Gear Head Mount Extender



133
Well Nuts



135
Camera Mount



130
Paddle Leash



290
R-5 Universal Rod Holder



367 Universal Fish Finder Mount



311
Cup Holder

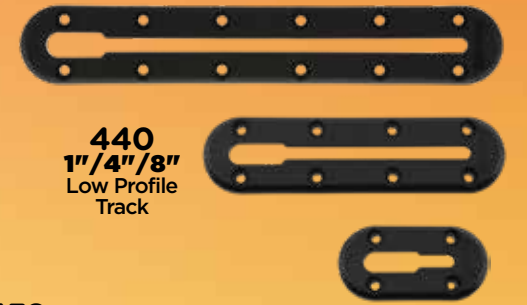

440
1"/4"/8"
Low Profile Track

438
Gear head track adaptor



141
Transducer Mount



838
Sea Light



150
1" Ball Mount



257
Triple Mount



368
Universal Fish Finder Mount



835
Sea Light



793
Throw Bag



151
1" Ball Mount



455
Bait Board & Accessory Tray



162
1 1/2" Ball Mount



163
1 1/2" Ball Mount



797
Anchor Kit

111 | kayak fishing

starter pack

Fishing essentials for outfitting your Kayak. The Kayak Starter Pack includes a 282 Baitcaster Spinning Rod Holder with Gear Head & Track, 438 Gear Head Track Adaptor, 440-4 4" Low Profile Track, 311 Drink Holder, 136 Paddle Clip and 455 Baitboard & Accessory Tray.

(Not intended for use with Inflatable Kayaks)

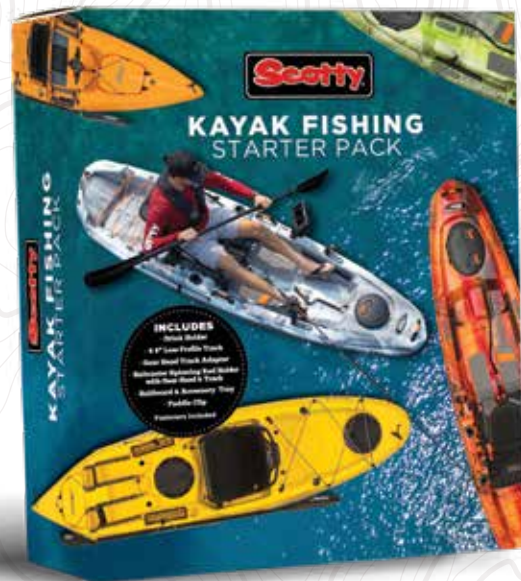

282
BAITCASTER SPINNING ROD HOLDER WITH GEAR HEAD & TRACK
Holds a Baitcaster reel securely in the cushioned cradle.

440-4
4" LOW PROFILE TRACK
Low Profile Track-top load design allows for quick and easy setup.

311
DRINK HOLDER
Fits cans, coffee mugs and insulated sleeves.

438
GEAR HEAD TRACK ADAPTOR
Slide the Gear Head into any of our 440 series track, twist the gear head clockwise to securely lock.

136
PADDLE CLIP
Holds your paddle, net, gaff & boat hook.

455
BAITBOARD & ACCESSORY TRAY
Exterior tray walls let you cut bait and prep lures.

Stainless steel fasteners Included: #10 x 5/8".



Sea-light

ACR detachable, fully sealed LED C-Light™, bright 20 Lumen White LED for location assistance during emergencies. Easy twist ON/OFF activation that is waterproof tested. Impact resistant construction and is USCG/SOLAS approved. C-Light™ is easily removed and can be attached to life jackets, backpacks or hang from a pocket. C-Light™ requires two AA 1.5V batteries (batteries not included) C-Light™ has an extensive and continuous operating life for over 30 hours.

835 SEA-LIGHT WITH SUCTION CUP MOUNT

A non-permanent safety addition that is perfectly portable for kayaks and small watercraft. Designed to meet the demands of the sea but also ideal for within a vehicle, for camping and whenever a reliable high efficient light is needed. Includes versatile suction cup mount for use in both salt and fresh water.

838 SEA-LIGHT WITH POLE & BALL MOUNT

The Scotty Ball System joint design enables a smooth and complete full range of motion for the Sea-Light. The corrosion proof construction of this system provides a long service life in both fresh and salt water applications as it is designed with stainless steel fasteners and a stainless pole. Base Mount Dimensions: 2 1/4" x 2 1/4" Overall Height: Stands 41" tall Sea-Light Pole Diameter: 1/2". Post Mount included.



803
12V WHITE NAVIGATION LIGHT
Surface mount.



806
12V RED NAVIGATION LIGHT
Masthead base.



774
WATERTIGHT STORAGE CONTAINER
1 litre capacity, o-ring sealed, square acme threads for an easy open and close lid.



789
WATERTIGHT FIRST AID KIT
(not available in the U.S.)



130
PADDLE LEASH



793
RESCUE THROW BAG



780
SAFETY WHISTLE
784
PEALESS SAFETY WHISTLE



779
SMALL VESSEL SAFETY EQUIPMENT

Pumps



545K
25 1/2" O.A.L.
KAYAK PUMP

548
39" O.A.L.
HAND PUMP



545
25 1/2" O.A.L.
HAND PUMP

544
18 1/2" O.A.L.
HAND PUMP



544K
18 1/2" O.A.L.
KAYAK PUMP



Jordan-Scotty

FISH EGG INCUBATOR SYSTEMS



• Locking tooth design helps hold the trays in place while in water

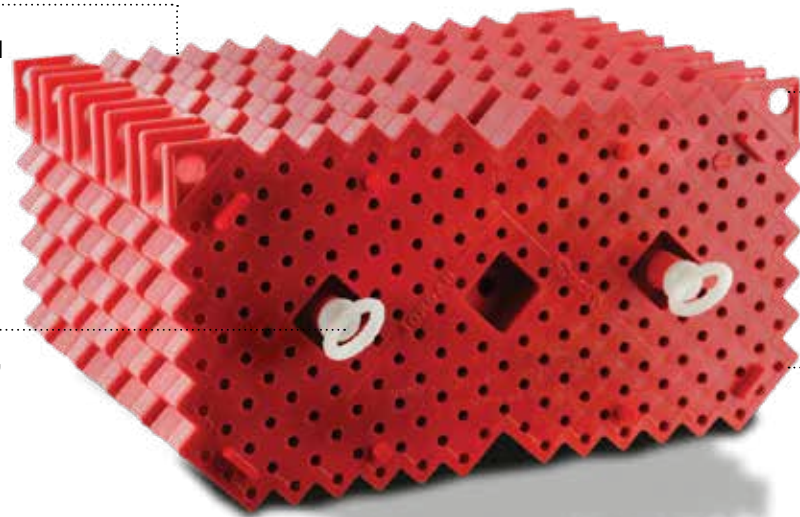

• Hold tabs for anchoring

• 12" nylon tie bolt, holds up to five sets at a time

• Nestling tabs leave space between trays for water flow



Checking your Results and Removing Incubator

When removing the incubator, care should be taken to not disturb the gravel, as this is where the fry are hidden.

Once removed, the incubator can be opened to reveal the success of the hatch rate. Wash incubators thoroughly and dry before storage. Store in a dark, dry place. With proper care, the Jordan/Scotty Incubator units can be used season after season.

If possible, please submit results of your project to your local Fisheries Department or hatchery, as well as Scotty. We would appreciate any information or report you can provide in order to log success rates and use of these units.

History and Design

The original incubator prototype was designed and tested by Mr. Fred Jordan, a Salmonid Technician for many years. He conceived the idea for stream enhancement during the 1980's. The success of his early experiments with this unit led to research, development and further design of the incubator by Scotty Manufacturing Ltd. Sidney, BC. This unit is extremely efficient and very compact. It is simple to use, durable, cost effective and practical, making it an excellent addition to enhancement projects.

The Jordan/Scotty Fish Egg Incubator is a scientifically designed and tested plastic incubation unit and was developed to provide an efficient aid in the stream incubating of fish eggs. The unique design either eliminates or minimizes most of the problems experienced by natural spawning. Fungus infection is virtually eliminated and eggs are protected from predators and silt suffocation. Testing and usage indicates that survival rates from egg to fry is often better than 65-95% as compared to natural spawning survival rates of between 5-20%.

In nature, high egg loss rates can easily be caused by poor fertilization, unsuccessful egg burial, fungus from dead eggs spreading to healthy eggs, attrition by predators, and silt suffocation. The Jordan-Scotty Fish Incubator addresses these issues and others. Egg quality can be checked during the loading process and all eggs are fertilized before loading. Eggs are quarantined from each other during development, limiting the spread of disease and fungal infection. Eggs are safe from predators and alevin are safely contained until their yolk sac have been absorbed, increasing survival rates.

Where and When to Obtain Eggs

Contact your local Department of Fisheries & Oceans or similar agency. In Canada, contact the DFO Community Advisor. The disposition of salmonid eggs is carefully supervised and controlled by DFO to ensure that all enhancement activities meet are requirements and conform to the department standards.

Protocols regarding the transfer of eggs must be approved by the federal-provincial Introductions and Transfers Committee. In British Columbia, a list of the community advisors in your area can be obtained by contacting the Habitat Enhancement Branch.