

SCHRADE®



TABLE OF CONTENTS

SCHRADE®

Assisted Opening	5-29
Folding Knives	31-63
Fixed Blades	66-105
Machetes, Axes and Spears	106-119
Tough Tools	120-125
Tactical Pens	126-129
Training Knives	130-131

UNCLE HENRY®

Traditional Staglon Folders	133-136
Select Series Lockbacks	137-138
Staglon Fixed Blades	139-147
Staglon Fillets	148-149

OLD TIMER®

Saw Cut Traditional Folders	150-159
Saw Cut Fixed Blades	160-163
Bone Handle Traditional Folders	164
Yellow Handle Traditional Folders	165
Desert Iron Wood Folders and Fixed Blades	166-167
Wood Handle Fixed Blades and Lockbacks	168-169
Copperhead Series	170-177
Old Timer® Tools	178-179

IMPERIAL®

Traditional Folders	181-186
Folding Knives and Combo Packs	187-195

ACCESSORIES

Sharpeners and Sheaths	196-199
Ferro Rods and Replacement Items	200
Promotional Items	201
Displays	201-203

All product specifications, including handle and blade materials, are subject to change without notice.

SCHRADE®



+ DUAL THUMB KNOBS



+ LINER LOCK



+ FRAME LOCK



+ FINGER ACTUATOR

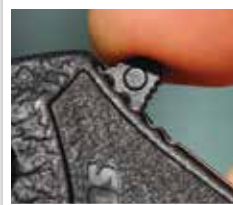

+ SAFETY LOCK



BLAZE THE NEW TRAIL

THE LEGACY OF SCHRADE® KNIVES AND TOOLS IS BUILT ON FINE CRAFTSMANSHIP, QUALITY AND DEPENDABILITY. OUR EXPANSIVE SCHRADE® LINE CONSISTS OF ASSISTED OPENING, FOLDING AND FIXED BLADE KNIVES INCLUDING MACHETES, AXES AND SPEARS. ALSO AVAILABLE, OUR SCHRADE® TOUGH TOOLS, TACTICAL PENS AND THE SCHRADE® PROFESSIONALS SERIES OF PRODUCTS ALL PRODUCED FROM PREMIUM MATERIALS AND BUILT FOR A LIFETIME.

SCHA13B

SCHRADE® ASSISTED OPENING

AUS-8 High Carbon S.S. Blade

Aluminum Handle

- + Dual Thumb Knobs
- + Liner Lock
- + Safety Lock
- + Finger Actuator
- + Pocket Clip

Blade Length
3.4" (8.7 cm)

Overall Length
7.7" (19.6 cm)

Weight
3.8 oz.

UPC
044356226103



SCHRADE®

SHIZNIT™ SERIES



SCHA13BS

SCHRADE® ASSISTED OPENING

AUS-8 High Carbon S.S. Blade

Aluminum Handle

- + Dual Thumb Knobs
- + Liner Lock
- + Safety Lock
- + Finger Actuator
- + Pocket Clip

Blade Length
3.4" (8.7 cm)

Overall Length
7.7" (19.6 cm)

Weight
3.8 oz.

UPC
044356226110



SCHRADE®

SHIZZLE® SERIES

AUS-8 High Carbon S.S. Blade Aluminum Handle

- + Dual Thumb Knobs
- + Liner Lock
- + Safety Lock
- + Finger Actuator
- + Repositionable Pocket Clip (Tip-Up/Down & Left/Right Options)

Left/Right Option

Tip-Down Carry

Tip-Up Carry



SCHA11B SHIZZLE®

Blade Length
3.4" (8.7 cm)
Overall Length
7.7" (19.4 cm)
Weight
4.4 oz.
UPC
044356224697



SCHA11BS SHIZZLE®

Blade Length
3.4" (8.7 cm)
Overall Length
7.7" (19.4 cm)
Weight
4.4 oz.
UPC
044356224703



Left/Right Option

Tip-Down Carry

Tip-Up Carry



SCHA11C SHIZZLE®

Blade Length
3.4" (8.7 cm)
Overall Length
7.7" (19.4 cm)
Weight
4.4 oz.
UPC
044356225267



SCHA11CS SHIZZLE®

Blade Length
3.4" (8.7 cm)
Overall Length
7.7" (19.4 cm)
Weight
4.4 oz.
UPC
044356225274



SCHRADE®

24/7® SERIES

AUS-8 Steel Blade Aluminum w/TPR Inserts Handle

- + Dual Thumb Knobs
- + Liner Lock
- + Safety Lock
- + Finger Actuator
- + Pocket Clip

SCHA8B 24/7® ASSISTED OPENING

Blade Length
3.2" (8.1 cm)
Overall Length
7.5" (19.1 cm)
Weight
4.9 oz.
UPC
044356222877



SCHA8BS 24/7® ASSISTED OPENING

Blade Length
3.2" (8.1 cm)
Overall Length
7.5" (19.1 cm)
Weight
4.9 oz.
UPC
044356222884



SCHA8C 24/7® ASSISTED OPENING

Blade Length
3.2" (8.1 cm)
Overall Length
7.5" (19.1 cm)
Weight
4.9 oz.
UPC
044356223775



SCHA8CS 24/7® ASSISTED OPENING

Blade Length
3.2" (8.1 cm)
Overall Length
7.5" (19.1 cm)
Weight
4.9 oz.
UPC
044356223782



SCHRADE®

LAND SHARK® SERIES

AUS-8 Steel Blade Aluminum Handle

- + Thumb Plate
- + Liner Lock
- + Safety Lock
- + Finger Actuator
- + Pocket Clip

SCHA9 LAND SHARK®

Blade Length
3.0" (7.6 cm)
Overall Length
7.0" (17.7 cm)
Weight
2.8 oz.
UPC
044356223294



SCHA9CP Clam Pack
UPC 044356224253



SCHA9S LAND SHARK®

Blade Length
3.0" (7.6 cm)
Overall Length
7.0" (17.7 cm)
Weight
2.8 oz.
UPC
044356223300



SCHA9SCP Clam Pack
UPC 044356224260



SCHA9C LAND SHARK®

colorshift

Blade Length
3.0" (7.6 cm)
Overall Length
7.0" (17.7 cm)
Weight
2.8 oz.
UPC
044356224277



SCHA9CCP Clam Pack
UPC 044356224284



SCHA9CS LAND SHARK®

colorshift

Blade Length
3.0" (7.6 cm)
Overall Length
7.0" (17.7 cm)
Weight
2.8 oz.
UPC
044356224291



SCHA9M MINI LAND SHARK®

Blade Length
2.2" (5.5 cm)
Overall Length
5.1" (13.1 cm)
Weight
1.6 oz.
UPC
044356224512



SCHA9MS MINI LAND SHARK®

Blade Length
2.2" (5.5 cm)
Overall Length
5.1" (13.1 cm)
Weight
1.6 oz.
UPC
044356224529



SCHA9MC MINI LAND SHARK®

colorshift

Blade Length
2.2" (5.5 cm)
Overall Length
5.1" (13.1 cm)
Weight
1.6 oz.
UPC
044356225243



SCHA9MCS MINI LAND SHARK®

colorshift

Blade Length
2.2" (5.5 cm)
Overall Length
5.1" (13.1 cm)
Weight
1.6 oz.
UPC
044356225250



SCHA5B ASSISTED OPENING

Blade Length
3.3" (8.4 cm)
Overall Length
7.6" (19.3 cm)
Weight
4.9 oz.
UPC
044356219068



SCHA5BCP Clam Pack
UPC 044356219211



AUS-8 Steel Blade Aluminum Handle

- + Dual Thumb Knobs
- + Liner Lock
- + Safety Lock
- + Finger Actuator
- + Pocket Clip

SCHA5BS ASSISTED OPENING

Blade Length
3.3" (8.4 cm)
Overall Length
7.6" (19.3 cm)
Weight
4.9 oz.
UPC
044356219075



SCHA5BR ASSISTED OPENING

Blade Length
3.3" (8.4 cm)
Overall Length
7.6" (19.3 cm)
Weight
4.9 oz.
UPC
044356219082



SCHA5BRS ASSISTED OPENING

Blade Length
3.3" (8.4 cm)
Overall Length
7.6" (19.3 cm)
Weight
4.9 oz.
UPC
044356219099



SCHA6LB ASSISTED OPENING

Blade Length
3.7" (9.4 cm)
Overall Length
8.6" (21.8 cm)
Weight
6.9 oz.
UPC
044356220293



AUS-8 Steel Blade Aluminum Handle

- + Thumb Plate
- + Liner Lock
- + Safety Lock
- + Glass Breaker
- + Finger Actuator
- + Pocket Clip

SCHA6LBS ASSISTED OPENING

Blade Length
3.7" (9.4 cm)
Overall Length
8.6" (21.8 cm)
Weight
6.9 oz.
UPC
044356220316



SCHA6L ASSISTED OPENING

Blade Length
3.7" (9.4 cm)
Overall Length
8.6" (21.8 cm)
Weight
6.9 oz.
UPC
044356220255



SCHA6LS ASSISTED OPENING

Blade Length
3.7" (9.4 cm)
Overall Length
8.6" (21.8 cm)
Weight
6.9 oz.
UPC
044356220279



SCHRADE®

SCHA7SM/SCHA7 SERIES

AUS-8 Steel Blade
Coarse Powder Coated Aluminum Handle

- + Dual Thumb Knobs
- + Liner Lock
- + Safety Lock
- + Finger Actuator
- + Pocket Clip



SCHA7SMGR / SMALL ASSISTED OPENING

Blade Length
2.6" (6.6 cm)
 Overall Length
5.9" (15.0 cm)
 Weight
2.6 oz.
 UPC
044356221108



SCHA7SMB / SMALL ASSISTED OPENING

Blade Length
2.6" (6.6 cm)
 Overall Length
5.9" (15.0 cm)
 Weight
2.6 oz.
 UPC
044356220712



SCHA7SMBS / SMALL ASSISTED OPENING

Blade Length
2.6" (6.6 cm)
 Overall Length
5.9" (15.0 cm)
 Weight
2.6 oz.
 UPC
044356220729



SCHA7BR

ASSISTED OPENING

Blade Length
3.3" (8.4 cm)
 Overall Length
7.6" (19.3 cm)
 Weight
4.8 oz.
 UPC
044356220651



SCHA7GR/SCHA7GRS

ASSISTED OPENING

Blade Length
3.3" (8.4 cm)
 Overall Length
7.6" (19.3 cm)
 Weight
4.8 oz.

SCHA7GR UPC
044356221085

SCHA7GRS UPC
044356221092



SCHA7B/SCHA7BS

ASSISTED OPENING

Blade Length
3.3" (8.4 cm)
 Overall Length
7.6" (19.3 cm)
 Weight
4.8 oz.

SCHA7B UPC
044356220637

SCHA7BS UPC
044356220644



SCHRADE®

SCHA4B SCHRADE® ASSISTED OPENING

4034 Stainless Steel Blade Aluminum Handle

- + Dual Thumb Knobs
- + Liner Lock
- + Safety Lock
- + Finger Actuator
- + Pocket Clip

Blade Length
3.3" (8.3 cm)
Overall Length
7.7" (19.5 cm)
Weight
5.1 oz.
UPC
044356216081



SCHA4BCP Clam Pack
UPC 044356216852



SCHA4BG SCHRADE® ASSISTED OPENING

4034 Stainless Steel Blade Aluminum Handle

- + Dual Thumb Knobs
- + Liner Lock
- + Safety Lock
- + Finger Actuator
- + Pocket Clip

Blade Length
3.3" (8.3 cm)
Overall Length
7.7" (19.5 cm)
Weight
5.1 oz.
UPC
044356216968



SCHA4BGCP Clam Pack
UPC 044356217033



SCHA4BGS SCHRADE® ASSISTED OPENING

4034 Stainless Steel Blade Aluminum Handle

- + Dual Thumb Knobs
- + Liner Lock
- + Safety Lock
- + Finger Actuator
- + Pocket Clip

Blade Length
3.3" (8.3 cm)
Overall Length
7.7" (19.5 cm)
Weight
5.1 oz.
UPC
044356216951



SCHA4BTS SCHRADE® ASSISTED OPENING

4034 Stainless Steel Blade Aluminum Handle

- + Dual Thumb Knobs
- + Liner Lock
- + Safety Lock
- + Finger Actuator
- + Pocket Clip

Blade Length
3.3" (8.3 cm)
Overall Length
7.7" (19.5 cm)
Weight
5.1 oz.
UPC
044356219266



SCHA4BGS SCHRADE® ASSISTED OPENING

4034 Stainless Steel Blade Aluminum Handle

- + Dual Thumb Knobs
- + Liner Lock
- + Safety Lock
- + Finger Actuator
- + Pocket Clip

Blade Length
3.3" (8.3 cm)
Overall Length
7.7" (19.5 cm)
Weight
5.1 oz.
UPC
044356219280



SCHA3 SCHRADE® ASSISTED OPENING

4034 Stainless Steel Blade Aluminum Handle

- + Thumb Plate
- + Liner Lock
- + Safety Lock
- + Finger Actuator
- + Pocket Clip

Blade Length
2.9" (7.3 cm)
Overall Length
7.3" (18.5 cm)
Weight
4.9 oz.
UPC
044356216784



SCHA3CP Clam Pack
UPC 044356216982



SCHA3S SCHRADE® ASSISTED OPENING

4034 Stainless Steel Blade Aluminum Handle

- + Thumb Plate
- + Liner Lock
- + Safety Lock
- + Finger Actuator
- + Pocket Clip

Blade Length
2.9" (7.3 cm)
Overall Length
7.3" (18.5 cm)
Weight
4.9 oz.
UPC
044356216791



SCHA3B SCHRADE® ASSISTED OPENING

4034 Stainless Steel Blade Aluminum Handle

- + Thumb Plate
- + Liner Lock
- + Safety Lock
- + Finger Actuator
- + Pocket Clip

Blade Length
2.9" (7.3 cm)
Overall Length
7.3" (18.5 cm)
Weight
4.9 oz.
UPC
044356216067



SCHA3BCP Clam Pack
UPC 044356216753



SCHA3BS SCHRADE® ASSISTED OPENING

4034 Stainless Steel Blade Aluminum Handle

- + Thumb Plate
- + Liner Lock
- + Safety Lock
- + Finger Actuator
- + Pocket Clip

Blade Length
2.9" (7.3 cm)
Overall Length
7.3" (18.5 cm)
Weight
4.9 oz.
UPC
044356216074



SCHA3CB SCHRADE® ASSISTED OPENING

colorshift

4034 Stainless Steel Blade Aluminum Handle

- + Thumb Plate
- + Liner Lock
- + Safety Lock
- + Finger Actuator
- + Pocket Clip

Blade Length
2.9" (7.3 cm)
Overall Length
7.3" (18.5 cm)
Weight
4.9 oz.
UPC
044356216760



SCHA3CBS SCHRADE® ASSISTED OPENING

colorshift

4034 Stainless Steel Blade Aluminum Handle

- + Thumb Plate
- + Liner Lock
- + Safety Lock
- + Finger Actuator
- + Pocket Clip

Blade Length
2.9" (7.3 cm)
Overall Length
7.3" (18.5 cm)
Weight
4.9 oz.
UPC
044356216777



SCHRADE®

DUAL ASSIST OPENING

AUS-8 Steel Blade
Aluminum Handle

- + Mode Selector Switch
- + Dual Thumb Knobs
- + Liner Lock
- + Finger Actuator
- + Pocket Clip



SCHA10B / **SCHRADE® DUAL ASSIST**

Blade Length
3.5" (8.8 cm)
Overall Length
8.1" (20.6 cm)
Weight
5.6 oz.
UPC
044356224222



SCHA10BS / **SCHRADE® DUAL ASSIST**

Blade Length
3.5" (8.8 cm)
Overall Length
8.1" (20.6 cm)
Weight
5.6 oz.
UPC
044356224239



SCHA12 / **DUAL ASSIST**

AUS-8 Steel Blade **Aluminum Handle**

Blade Length
3.4" (8.7 cm)
Overall Length
8.1" (20.6 cm)
Weight
5.3 oz.
UPC
044356226363



SCHA12S / **DUAL ASSIST**

AUS-8 Steel Blade **Aluminum Handle**

Blade Length
3.4" (8.7 cm)
Overall Length
8.1" (20.6 cm)
Weight
5.3 oz.
UPC
044356226370



SCHA12B / **DUAL ASSIST**

AUS-8 Steel Blade **Aluminum Handle**

Blade Length
3.4" (8.7 cm)
Overall Length
8.1" (20.6 cm)
Weight
5.3 oz.
UPC
044356225793



SCHA12BCP Clam Pack
UPC 044356227346



SCHA12BS / **DUAL ASSIST**

AUS-8 Steel Blade **Aluminum Handle**

Blade Length
3.4" (8.7 cm)
Overall Length
8.1" (20.6 cm)
Weight
5.3 oz.
UPC
044356225809



- + Mode Selector Switch
- + Dual Thumb Knobs
- + Liner Lock
- + Finger Actuator
- + Reversible Pocket Clip

SCHA14B

SCHRADE® BONEYARD REAPER

NEW

Blade Length
3.3" (8.4 cm)
Overall Length
7.7" (19.5 cm)
Weight
5.1 oz.
UPC
044356228633



AUS-8 High Carbon Stainless Steel Blade
Aluminum Handle

- + M.A.G.I.C. Assisted Opening
- + Dual Thumb Knobs
- + Liner Lock
- + Pocket Clip

SCHRADE®
BONEYARD SERIES

SCHA15BS

SCHRADE® BONEYARD SPIDER

NEW

Blade Length
3.3" (8.4 cm)
Overall Length
7.7" (19.5 cm)
Weight
5.5 oz.
UPC
044356228640



SCHA16B

SCHRADE® BONEYARD LAZY BONES

NEW

Blade Length
3.2" (8.0 cm)
Overall Length
7.5" (19.1 cm)
Weight
5.1 oz.
UPC
044356228657



B  **ONEYARD**

SCHRADE®

VIPER® SCHOTF3 SERIES

4034 Stainless Steel Blade
Aluminum Handle

- + Blade Release
- + Safety Lock
- + Glass Breaker
- + Blade Slider
- + Pocket Clip



SCHOTF3B VIPER® OTF ASSISTED OPENING

Blade Length
3.5" (8.8 cm)
Overall Length
8.8" (22.4 cm)
Weight
4.9 oz.
UPC
044356214001
No Ship CA, NY, MA



SCHOTF3 VIPER® OTF ASSISTED OPENING

Blade Length
3.5" (8.8 cm)
Overall Length
8.8" (22.4 cm)
Weight
4.9 oz.
UPC
044356213998
No Ship CA, NY, MA



SCHOTF3BS VIPER® OTF ASSISTED OPENING

Blade Length
3.5" (8.8 cm)
Overall Length
8.8" (22.4 cm)
Weight
4.9 oz.
UPC
044356214605
No Ship CA, NY, MA



SCHOTF3S VIPER® OTF ASSISTED OPENING

Blade Length
3.5" (8.8 cm)
Overall Length
8.8" (22.4 cm)
Weight
4.9 oz.
UPC
044356214599
No Ship CA, NY, MA



SCHOTF3CB VIPER® OTF ASSISTED OPENING

Blade Length
3.5" (8.8 cm)
Overall Length
8.8" (22.4 cm)
Weight
4.9 oz.
UPC
044356222471
No Ship CA, NY, MA



SCHOTF3C VIPER® OTF ASSISTED OPENING

Blade Length
3.5" (8.8 cm)
Overall Length
8.8" (22.4 cm)
Weight
4.9 oz.
UPC
044356222464
No Ship CA, NY, MA



SCHRADE®

VIPER® SCHOTF8 SERIES

AUS-8 Steel Blade
Aluminum Handle

- + Blade Release
- + Safety Lock
- + Finger Actuator
- + Blade Slider
- + Pocket Clip



SCHOTF8TB / VIPER® OTF ASSISTED OPENING

Blade Length
3.4" (8.5 cm)
Overall Length
8.5" (21.6 cm)
Weight
4.4 oz.
UPC
044356222624

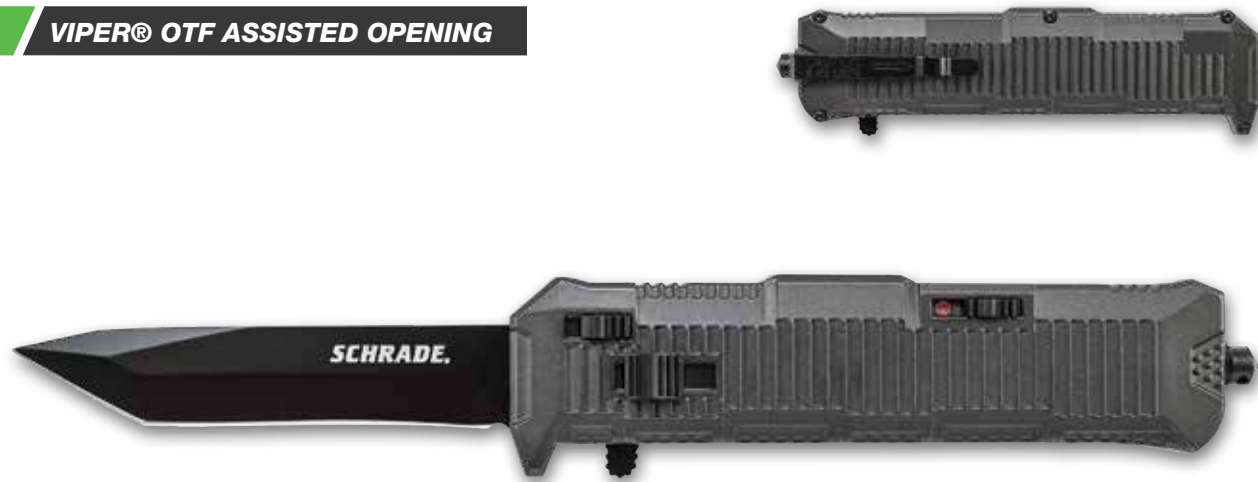

SCHOTF8TBS / VIPER® OTF ASSISTED OPENING

Blade Length
3.4" (8.5 cm)
Overall Length
8.5" (21.6 cm)
Weight
4.4 oz.
UPC
044356222631

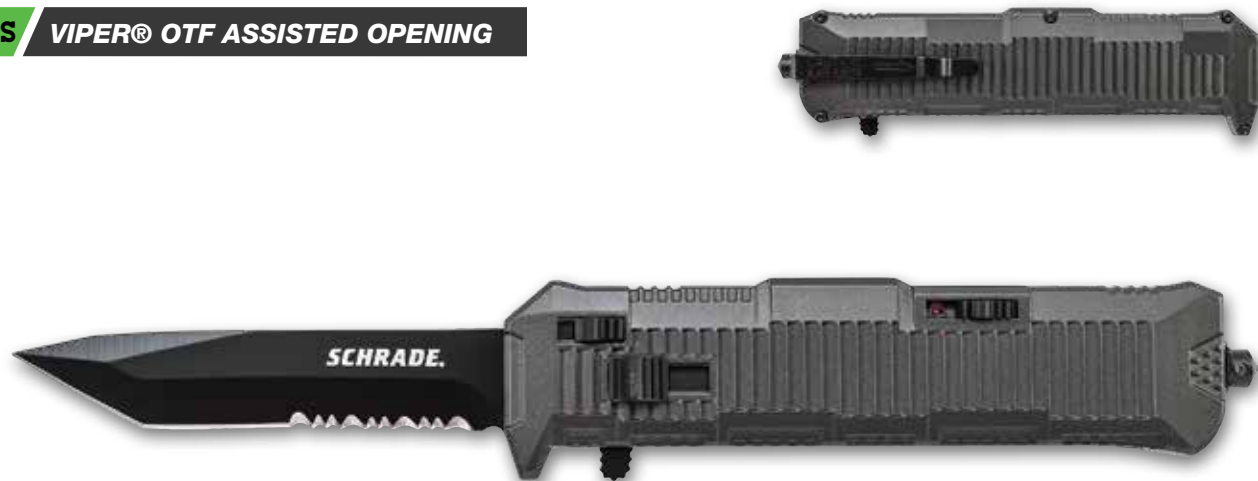

SCHOTF8B / VIPER® OTF ASSISTED OPENING

Blade Length
3.4" (8.5 cm)
Overall Length
8.5" (21.6 cm)
Weight
4.4 oz.
UPC
044356222600
No Ship CA, NY, MA



SCHOTF8BS / VIPER® OTF ASSISTED OPENING

Blade Length
3.4" (8.5 cm)
Overall Length
8.5" (21.6 cm)
Weight
4.4 oz.
UPC
044356222617
No Ship CA, NY, MA





SCHOTF7BS VIPER® OTF ASSISTED OPENING

AUS-8 Steel Blade
Aluminum Handle

- + Blade Release
- + Safety Lock
- + Glass Breaker
- + Blade Slider
- + Pocket Clip

Blade Length
3.6" (9.1 cm)
Overall Length
9.1" (23.1cm)
Weight
6.2 oz.
UPC
044356219846



SCHOTF6 VIPER® OTF ASSISTED OPENING

AUS-8 Steel Blade
Aluminum Handle

- + Blade Release
- + Safety Lock
- + Glass Breaker
- + Blade Slider
- + Pocket Clip

Blade Length
3.6" (9.1 cm)
Overall Length
9.1" (23.1 cm)
Weight
6.2 oz.
UPC
044356219839
No Ship CA, NY, MA



SCHSA3DB VIPER® SIDE ASSISTED OPENING

4034 Stainless Steel Blade
Aluminum Handle

- + Blade Release
- + Punch Hole
- + Safety Lock
- + Pocket Clip

Blade Length
2.5" (6.3 cm)
Overall Length
6.2" (15.6 cm)
Weight
2.6 oz.
UPC
044356217170



SCHSA3DBCP Clam Pack
UPC 044356216883



SCHRADE® PROFESSIONALS

SCHA911 SERIES

- + Dual Thumb Knobs
- + Liner Lock
- + Safety Lock
- + Strap Cutter
- + Spring Loaded Glass Punch
- + Finger Actuator
- + Pocket Clip

SCHA911B SCHRADE® ASSISTED OPENING

AUS-8 Steel Blade
Aluminum Handle

Blade Length
3.8" (9.6 cm)
Overall Length
8.6" (21.8 cm)
Weight
7.9 oz.
UPC
044356220507



SCHA911R SCHRADE® ASSISTED OPENING

AUS-8 Steel Blade
Aluminum Handle

Blade Length
3.8" (9.6 cm)
Overall Length
8.6" (21.8 cm)
Weight
7.9 oz.
UPC
044356220514



SCH911 SERIES

- + Dual Thumb Knobs
- + Safety Lock/Liner Lock
- + Strap Cutter
- + Glass Breaker
- + Oxygen Tank Wrench
- + Finger Actuator
- + Pocket Clip

SCH911 SCHRADE® ASSISTED OPENING

4034 Stainless Steel Blade
Nylon Fiber Handle

Blade Length
3.4" (8.6 cm)
Overall Length
8.4" (21.3 cm)
Weight
5.6 oz.
UPC
044356202930



SCH911DBS SCHRADE® ASSISTED OPENING

4034 Stainless Steel Blade
Nylon Fiber Handle

Blade Length
3.5" (9.0 cm)
Overall Length
8.3" (21.0 cm)
Weight
5.6 oz.
UPC
044356205023



SCHRADE®

FOLDING KNIVES



// SCHRADE® // FOLDING KNIVES //

SCHRADE®

BALISONG MANILLA FOLDER



MADE IN
USA



NEW

SCMF

SCHRADE® BALISONG MANILLA FOLDER

No Ship CA, NY, MA

Blade Steel	D2 High Carbon Steel	Overall Length	9.0" (22.8 cm)
Handle Material	Stainless Steel	Weight	7.9 oz.
Blade Length	4.0" (10.2 cm)	UPC	044356229135

SCHRADE®

4116 Steel Blade Aluminum Handle

- + Push Button Lock
- + Safety Lock
- + Glass Breaker
- + Reversible Pocket Clip

SC60MB

Blade Length
2.4" (6.1 cm)
Overall Length
6.1" (15.5 cm)
Weight
2.3 oz.
UPC
044356219372



SC60MBS

Blade Length
2.4" (6.1 cm)
Overall Length
6.1" (15.5 cm)
Weight
2.3 oz.
UPC
044356219389



SC60MBTS

Blade Length
2.4" (6.1 cm)
Overall Length
6.1" (15.5 cm)
Weight
2.3 oz.
UPC
044356219402

SCHRADE®

4116 Steel Blade Aluminum Handle

- + Push Button Lock
- + Safety Lock
- + Glass Breaker
- + Reversible Pocket Clip

SC60B

Blade Length
3.3" (8.3 cm)
Overall Length
7.8" (19.9 cm)
Weight
3.7 oz.
UPC
044356202091



SC60BS

Blade Length
3.3" (8.3 cm)
Overall Length
7.8" (19.9 cm)
Weight
3.7 oz.
UPC
044356202107

SC60BT

Blade Length
3.3" (8.3 cm)
Overall Length
7.8" (19.9 cm)
Weight
3.7 oz.
UPC
044356202114



SC60BTS

Blade Length
3.3" (8.3 cm)
Overall Length
7.8" (19.9 cm)
Weight
3.7 oz.
UPC
044356202121

URBAN CAMO

4116 Steel Blade Aluminum Handle

- + Push Button Lock
- + Safety Lock
- + Glass Breaker
- + Reversible Pocket Clip

SC60MC

Blade Length
2.4" (6.1 cm)
Overall Length
6.1" (15.5 cm)
Weight
2.3 oz.
UPC
044356225915



SC60MCS

Blade Length
2.4" (6.1 cm)
Overall Length
6.1" (15.5 cm)
Weight
2.3 oz.
UPC
044356225922



SC60MCT

Blade Length
2.4" (6.1 cm)
Overall Length
6.1" (15.5 cm)
Weight
2.3 oz.
UPC
044356225939



SC60MCTS

Blade Length
2.4" (6.1 cm)
Overall Length
6.1" (15.5 cm)
Weight
2.3 oz.
UPC
044356225946



URBAN CAMO

4116 Steel Blade Aluminum Handle

- + Push Button Lock
- + Safety Lock
- + Glass Breaker
- + Reversible Pocket Clip

SC60C

Blade Length
3.3" (8.3 cm)
Overall Length
7.8" (19.9 cm)
Weight
3.7 oz.
UPC
044356225830



SC60CS

Blade Length
3.3" (8.3 cm)
Overall Length
7.8" (19.9 cm)
Weight
3.7 oz.
UPC
044356225847



SC60CT

Blade Length
3.3" (8.3 cm)
Overall Length
7.8" (19.9 cm)
Weight
3.7 oz.
UPC
044356225854



SC60CTS

Blade Length
3.3" (8.3 cm)
Overall Length
7.8" (19.9 cm)
Weight
3.7 oz.
UPC
044356225861



DESERT CAMO

4116 Steel Blade Aluminum Handle

- + Push Button Lock + Safety Lock
- + Glass Breaker + Reversible Pocket Clip

SC60MD

Blade Length
2.4" (6.1 cm)
Overall Length
6.1" (15.5 cm)
Weight
2.3 oz.
UPC
044356225953



SC60MDS

Blade Length
2.4" (6.1 cm)
Overall Length
6.1" (15.5 cm)
Weight
2.3 oz.
UPC
044356225960

SC60MDT

Blade Length
2.4" (6.1 cm)
Overall Length
6.1" (15.5 cm)
Weight
2.3 oz.
UPC
044356225977



SC60MDTS

Blade Length
2.4" (6.1 cm)
Overall Length
6.1" (15.5 cm)
Weight
2.3 oz.
UPC
044356225984



DESERT CAMO

4116 Steel Blade Aluminum Handle

- + Push Button Lock + Safety Lock
- + Glass Breaker + Reversible Pocket Clip

SC60D

Blade Length
3.3" (8.3 cm)
Overall Length
7.8" (19.9 cm)
Weight
3.7 oz.
UPC
044356225878

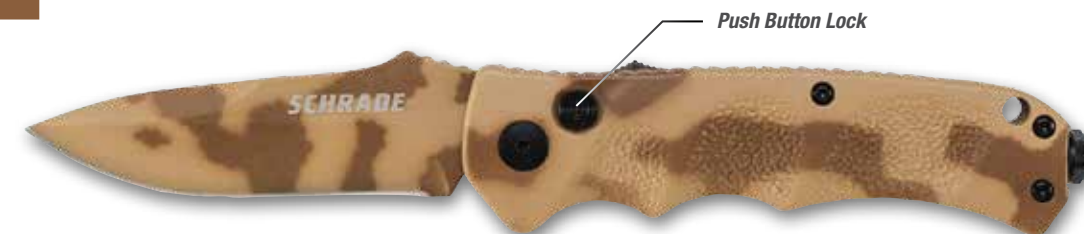

SC60DS

Blade Length
3.3" (8.3 cm)
Overall Length
7.8" (19.9 cm)
Weight
3.7 oz.
UPC
044356225885

SC60DT

Blade Length
3.3" (8.3 cm)
Overall Length
7.8" (19.9 cm)
Weight
3.7 oz.
UPC
044356225892



SC60DTS

Blade Length
3.3" (8.3 cm)
Overall Length
7.8" (19.9 cm)
Weight
3.7 oz.
UPC
044356225908



SCHRADE®

AUS-8 High Carbon S.S. Blade Aluminum Handle

- + Push Button Lock
- + Glass Breaker
- + Safety Lock
- + Reversible Pocket Clip

SC90B SCHRADE® FOLDING KNIFE

Blade Length
3.2" (8.0 cm)
Overall Length
7.8" (19.9 cm)
Weight
3.5 oz.
UPC
044356226080



SC90BS SCHRADE® FOLDING KNIFE

Blade Length
3.2" (8.0 cm)
Overall Length
7.8" (19.9 cm)
Weight
3.5 oz.
UPC
044356226097



SCH401 SCHRADE® FOLDING KNIFE

Ceramic Blade Carbon Fiber Handle

- + Dual Thumb Knobs
- + Liner Lock
- + Pocket Clip

Blade Length
2.7" (6.8 cm)
Overall Length
6.5" (16.5 cm)
Weight
1.6 oz.
UPC
044356219105



SCH401CP Clam Pack
UPC 044356219334



SCH401ALBK SCHRADE® FOLDING KNIFE

8Cr13MoV High Carbon Stainless Steel Blade Aluminum Handle

- + Dual Thumb Knobs
- + Liner Lock
- + Pocket Clip

Blade Length
2.7" (6.8 cm)
Overall Length
6.5" (16.5 cm)
Weight
2.1 oz.
UPC
044356223355



SCH404L SCHRADE® FOLDING KNIFE

Ceramic Blade Textured G-10 Handle

- + Dual Thumb Knobs
- + Liner Lock
- + Pocket Clip

Blade Length
3.2" (8.1 cm)
Overall Length
7.8" (19.8 cm)
Weight
2.3 oz.
UPC
044356222150



SCH402 SCHRADE® FOLDING KNIFE

Ceramic Blade
Carbon Fiber Handle

- + Dual Thumb Knobs
- + Liner Lock
- + Pocket Clip

Blade Length
2.7" (6.8 cm)
Overall Length
6.5" (16.5 cm)
Weight
1.6 oz.
UPC
044356219129



SCH402L SCHRADE® FOLDING KNIFE

Ceramic Blade
Carbon Fiber Handle

- + Dual Thumb Knobs
- + Liner Lock
- + Pocket Clip

Blade Length
3.4" (8.6 cm)
Overall Length
7.7" (19.5 cm)
Weight
2.3 oz.
UPC
044356219136



SCH405 SCHRADE® FOLDING KNIFE

Ceramic Blade
Carbon Fiber Handle

- + Liner Lock
- + Pocket Clip

Blade Length
2.4" (6.1 cm)
Overall Length
5.6" (14.2 cm)
Weight
1.2 oz.
UPC
044356222518



SCH406 SCHRADE® NECK KNIFE

Ceramic Blade

- + Full Tang Neck Knife
- + 550 Paracord
- + Nylon Fiber Neck Sheath

Blade Length
2.3" (5.8 cm)
Overall Length
5.2" (13.2 cm)
Weight
1.4 oz.
UPC
044356222549



SCH406N SCHRADE® NECK KNIFE

8Cr13MoV High Carbon S.S. Blade

- + Full Tang Neck Knife
- + 550 Paracord
- + Nylon Fiber Neck Sheath

Blade Length
2.3" (5.8 cm)
Overall Length
5.2" (13.2 cm)
Weight
1.9 oz.
UPC
044356224000



SCH407 SCHRADE® FOLDING KNIFE

Ceramic Blade
Textured ABS & TPR Handle

- + Dual Thumb Knobs
- + Liner Lock
- + Pocket Clip

Blade Length
2.9" (7.4 cm)
Overall Length
6.8" (17.1 cm)
Weight
1.9 oz.
UPC
044356222860



SCH403 SCHRADE® FOLDING KNIFE

9Cr18MoV High Carbon S.S. Blade
Carbon Fiber Handle

- + Dual Thumb Knobs
- + Liner Lock
- + Pocket Clip

Blade Length
3.3" (8.4 cm)
Overall Length
7.7" (19.6 cm)
Weight
3.9 oz.
UPC
044356222181



SCHRADE®

SCH107 SCHRADE® FOLDING KNIFE

8Cr13MoV High Carbon S.S. Blade
Textured G-10 Handle

- + Dual Thumb Knobs
- + Liner Lock
- + Pocket Clip

Blade Length
2.5" (6.3 cm)
Overall Length
6.0" (15.2 cm)
Weight
2.1 oz.
UPC
044356218870



SCH107CP Clam Pack
UPC 044356218986

SCH107ALBK SCHRADE® FOLDING KNIFE

8Cr13MoV High Carbon S.S. Blade
Aluminum Handle

- + Dual Thumb Knobs
- + Liner Lock
- + Pocket Clip

Blade Length
2.5" (6.3 cm)
Overall Length
6.0" (15.2 cm)
Weight
1.8 oz.
UPC
044356223317



SCH107ALBKCP Clam Pack
UPC 044356223584

SCH106ALC SCHRADE® FOLDING KNIFE

8Cr13MoV High Carbon S.S. Blade
Aluminum Handle

- + Dual Thumb Knobs
- + Liner Lock
- + Pocket Clip

Blade Length
2.9" (7.3 cm)
Overall Length
6.7" (17.0 cm)
Weight
2.3 oz.
UPC
044356224079



SCH106ALCCP Clam Pack
UPC 044356224086

colorshift
A new color at every angle!



SCH107ALOR SCHRADE® FOLDING KNIFE

8Cr13MoV High Carbon S.S. Blade
Aluminum Handle

- + Dual Thumb Knobs
- + Liner Lock
- + Pocket Clip

Blade Length
2.5" (6.3 cm)
Overall Length
6.0" (15.2 cm)
Weight
1.8 oz.
UPC
044356223324



SCH107ALORCP Clam Pack
UPC 044356223591

SCHRADE® POCKET PROTECTOR®

**8Cr13MoV High Carbon S.S. Blade
Aluminum & Stainless Steel Handle**

- + Dual Thumb Knobs
- + Frame Lock
- + Carabiner Clip
- + Money/Pocket Clip



SCH222BK SCHRADE® FOLDING KNIFE

Blade Length
2.6" (6.5 cm)
Overall Length
5.8" (14.7 cm)
Weight
1.4 oz.
UPC
044356225519



SCH222BKCP Clam Pack
UPC 044356226394



SCH222G SCHRADE® FOLDING KNIFE

Blade Length
2.6" (6.5 cm)
Overall Length
5.8" (14.7 cm)
Weight
1.4 oz.
UPC
044356225533



SCH222GCP Clam Pack
UPC 044356226400



SCH222P SCHRADE® FOLDING KNIFE

Blade Length
2.6" (6.5 cm)
Overall Length
5.8" (14.7 cm)
Weight
1.4 oz.
UPC
044356225540



SCH222PCP Clam Pack
UPC 044356226417



SCH224 SCHRADE® FOLDING KNIFE

**Titanium Coated 8Cr13MoV High Carbon S.S. Blade
Aluminum Handle**

- + Thumb Knob
- + Liner Lock
- + Pocket Clip

Blade Length
2.8" (7.0 cm)
Overall Length
6.6" (16.8 cm)
Weight
2.9 oz.
UPC
044356227209



SCH224CP Clam Pack
UPC 044356227643



SCH221OR SCHRADE® FOLDING KNIFE

**9Cr18MoV High Carbon S.S. Blade
Aluminum Handle**

- + Thumb Knob
- + Liner Lock
- + Pocket Clip

Blade Length
3.5" (8.8 cm)
Overall Length
8.4" (21.3 cm)
Weight
4.9 oz.
UPC
044356223577



SCH221BK SCHRADE® FOLDING KNIFE

**9Cr18MoV High Carbon S.S. Blade
Aluminum Handle**

- + Thumb Knob
- + Liner Lock
- + Pocket Clip

Blade Length
3.5" (8.8 cm)
Overall Length
8.4" (21.3 cm)
Weight
4.9 oz.
UPC
044356223560



SCH221BKCP Clam Pack
UPC 044356223713



SCH206 SCHRADE® FOLDING KNIFE

**8Cr13MoV High Carbon Stainless Steel Blade
Aluminum Handle**

- + Dual Thumb Knobs
- + Liner Lock
- + Pocket Clip

Blade Length
3.0" (7.6 cm)
Overall Length
7.5" (19.1 cm)
Weight
4.6 oz.
UPC
044356220460



SCH208 SCHRADE® FOLDING KNIFE

**8Cr13MoV High Carbon Stainless Steel Blade
Aluminum Handle**

- + Dual Thumb Knobs
- + Liner Lock
- + Pocket Clip

Blade Length
3.1" (7.9 cm)
Overall Length
7.6" (19.3 cm)
Weight
4.6 oz.
UPC
044356220484



SCH207 SCHRADE® FOLDING KNIFE

**8Cr13MoV High Carbon Stainless Steel Blade
Aluminum Handle**

- + Dual Thumb Knobs
- + Liner Lock
- + Pocket Clip

Blade Length
3.3" (8.4 cm)
Overall Length
7.8" (19.8 cm)
Weight
4.6 oz.
UPC
044356220477



SCH209 SCHRADE® FOLDING KNIFE

**8Cr13MoV High Carbon Stainless Steel Blade
Aluminum Handle**

- + Dual Thumb Knobs
- + Liner Lock
- + Pocket Clip

Blade Length
3.2" (8.1 cm)
Overall Length
7.6" (19.3 cm)
Weight
4.6 oz.
UPC
044356220491



SCH002 SCHRADE® FOLDING KNIFE

8Cr13MoV High Carbon S.S. Blade
ABS & TPR Handle

- + Dual Thumb Knobs
- + Liner Lock
- + Index Flipper
- + Pocket Clip

Blade Length
3.4" (8.5 cm)
Overall Length
7.9" (19.9 cm)
Weight
3.7 oz.
UPC
044356225663



SCH002CP Clam Pack
UPC 044356228534

SCHRADE®

SCH001 SCHRADE® FOLDING KNIFE

8Cr13MoV High Carbon S.S. Blade
ABS & TPR Handle

- + Dual Thumb Knobs
- + Liner Lock
- + Index Flipper
- + Pocket Clip

Blade Length
3.3" (8.3 cm)
Overall Length
7.9" (20.1 cm)
Weight
4.4 oz.
UPC
044356221450



SCH001CP Clam Pack
UPC 044356221467

SCHRADE®

SCH002S SCHRADE® FOLDING KNIFE

8Cr13MoV High Carbon S.S. Blade
ABS & TPR Handle

- + Dual Thumb Knobs
- + Liner Lock
- + Index Flipper
- + Pocket Clip

Blade Length
3.4" (8.5 cm)
Overall Length
7.9" (19.9 cm)
Weight
3.7 oz.
UPC
044356225670



SCH003 SCHRADE® FOLDING KNIFE

NEW

8Cr13MoV High Carbon S.S. Blade PP & GF Handle

- + Dual Thumb Knobs
- + Liner Lock
- + Index Flipper
- + Pocket Clip

Blade Length
3.5" (8.9 cm)
Overall Length
8.2" (20.9 cm)
Weight
4.1 oz.
UPC
044356228701



SCH003CP Clam Pack
UPC 044356229531

SCHRADE®

DOUBLE LOCKBACK

8Cr13MoV High Carbon S.S. Blade
Rubber Coated Aluminum Handle

- + Thumb Holes
- + Double Lockback
- + Pocket Clip



SCH004DLB SCHRADE® DOUBLE LOCKBACK



Blade Length
2.3" (5.8 cm)
 Overall Length
7.4" (18.7 cm)
 Weight
2.1 oz.
 UPC
044356229029



SCH005DLB SCHRADE® DOUBLE LOCKBACK



Blade Length
2.9" (7.3 cm)
 Overall Length
9.5" (24.0 cm)
 Weight
3.3 oz.
 UPC
044356229036



SCH223 SCHRADE® FOLDING KNIFE

9Cr18MoV High Carbon S.S. Blade
Aluminum Handle

- + Dual Thumb Knobs
- + Liner Lock
- + Index Flipper/Finger Guard
- + Pocket Clip

Blade Length
3.6" (9.1 cm)
 Overall Length
8.1" (20.5 cm)
 Weight
4.6 oz.
 UPC
044356225649



SCH223S SCHRADE® FOLDING KNIFE

9Cr18MoV High Carbon S.S. Blade
Aluminum Handle

- + Dual Thumb Knobs
- + Liner Lock
- + Index Flipper/Finger Guard
- + Pocket Clip

Blade Length
3.6" (9.1 cm)
 Overall Length
8.1" (20.5 cm)
 Weight
4.6 oz.
 UPC
044356225656



SCHRADE®

SCH109 SCHRADE® FOLDING KNIFE

**9Cr18MoV High Carbon Stainless Steel Blade
Textured G-10 Handle**

- + Dual Thumb Knobs
- + Liner Lock
- + Index Flipper
- + Pocket Clip

Blade Length
3.5" (8.9 cm)
Overall Length
8.2" (20.8 cm)
Weight
5.3 oz.
UPC
044356222211



SCHRADE®

SCH510 SCHRADE® SURE-LOCK®

NEW

SCHRADE®

**AUS-8 High Carbon S.S. Blade
Aluminum & TPR Handle**

- + Dual Thumb Knobs
- + SURE-LOCK®
- + Pocket Clip

Blade Length
3.5" (8.8 cm)
Overall Length
8.4" (21.4 cm)
Weight
7.0 oz.
UPC
044356229937



SURE-LOCK® Mechanism
Rated to 325 Pounds

SCH510CP Clam Pack
UPC 044356229944

SCH509R SCHRADE® FOLDING KNIFE

NEW

**9Cr18MoV High Carbon Stainless Steel Blade
Rainbow Titanium Coated Aluminum Handle**

- + Dual Thumb Knobs
- + Liner Lock
- + Index Flipper
- + Pocket Clip

Blade Length
3.4" (8.6 cm)
Overall Length
7.9" (20.1 cm)
Weight
5.1 oz.
UPC
044356229098



SCH509RCP Clam Pack
UPC 044356229104

SCH510S SCHRADE® SURE-LOCK®

NEW

**AUS-8 High Carbon S.S. Blade
Aluminum & TPR Handle**

- + Dual Thumb Knobs
- + SURE-LOCK®
- + Pocket Clip

Blade Length
3.5" (8.8 cm)
Overall Length
8.4" (21.4 cm)
Weight
7.0 oz.
UPC
044356229951



SCHRADE® SURE-LOCK® SERIES

- AUS-8 High Carbon S.S. Blade
Aluminum Handle**
- + Dual Thumb Knobs
 - + SURE-LOCK® Certified Tested to Resist 325 Pounds of Force (LBF)
 - + Pocket Clip

THE MOST DEPENDABLE BLADE LOCK ON THE PLANET.
**BECAUSE FINGERS,
THAT'S WHY. RELY
ON YOU**

SCH503 SCHRADE® SURE-LOCK®

- Blade Length**
3.6" (9.3 cm)
Overall Length
8.5" (21.6 cm)
Weight
6.4 oz.
UPC
044356226196

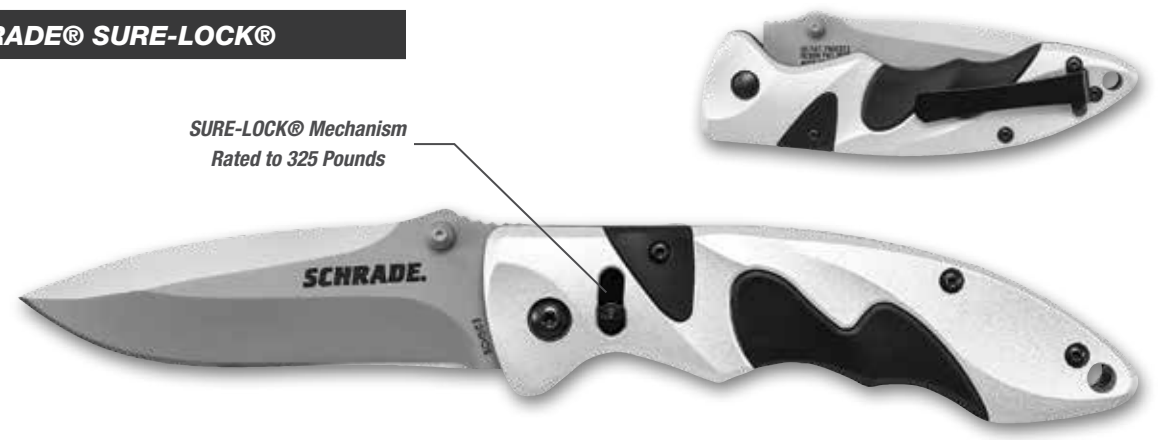

SCH503B SCHRADE® SURE-LOCK®

- Blade Length**
3.6" (9.3 cm)
Overall Length
8.5" (21.6 cm)
Weight
6.4 oz.
UPC
044356225816



SCH503RB SCHRADE® SURE-LOCK®

- Blade Length**
3.6" (9.3 cm)
Overall Length
8.5" (21.6 cm)
Weight
6.4 oz.
UPC
044356225823



SCH501 SCHRADE® FOLDING KNIFE

**9Cr18MoV High Carbon Stainless Steel Blade
G-10 w/Aluminum Handle**

- + Dual Thumb Knobs
- + Liner Lock
- + Glass Breaker
- + Index Flipper
- + Pocket Clip

- Blade Length**
3.2" (8.1 cm)
Overall Length
7.8" (19.8 cm)
Weight
5.1 oz.
UPC
044356220996



SCH501S SCHRADE® FOLDING KNIFE

**9Cr18MoV High Carbon Stainless Steel Blade
G-10 w/Aluminum Handle**

- + Dual Thumb Knobs
- + Liner Lock
- + Glass Breaker
- + Index Flipper
- + Pocket Clip

- Blade Length**
3.2" (8.1 cm)
Overall Length
7.8" (19.8 cm)
Weight
5.1 oz.
UPC
044356219631



SCHRADE®

SCH504 SCHRADE® FOLDING KNIFE

9Cr18MoV High Carbon S.S. Blade
Aluminum Handle

- + Dual Thumb Knobs
- + Liner Lock
- + Index Flipper
- + Pocket Clip

Blade Length
3.4" (8.7 cm)
Overall Length
7.9" (20.0 cm)
Weight
4.7 oz.
UPC
044356227230



SCH506 SCHRADE® FOLDING KNIFE

9Cr18MoV High Carbon S.S. Blade
Aluminum Handle

- + Dual Thumb Knobs
- + Liner Lock
- + Index Flipper
- + Pocket Clip

Blade Length
3.3" (8.5 cm)
Overall Length
8.1" (20.6 cm)
Weight
5.6 oz.
UPC
044356227254

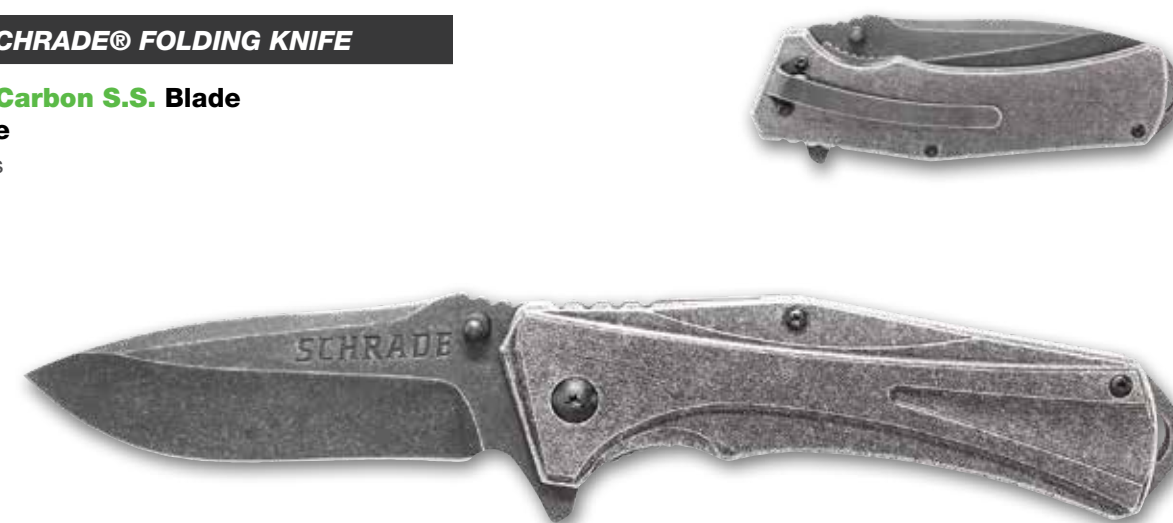

SCH505 SCHRADE® FOLDING KNIFE

9Cr18MoV High Carbon S.S. Blade
G-10 w/Aluminum Handle

- + Dual Thumb Knobs
- + Liner Lock
- + Pocket Clip

Blade Length
3.5" (8.9 cm)
Overall Length
8.1" (20.5 cm)
Weight
5.1 oz.
UPC
044356227711



SCH507 SCHRADE® FOLDING KNIFE

9Cr18MoV High Carbon S.S. Blade
Aluminum w/G-10 Handle

- + Dual Thumb Knobs
- + Liner Lock
- + Index Flipper
- + Pocket Clip

Blade Length
3.3" (8.5 cm)
Overall Length
7.8" (19.9 cm)
Weight
4.8 oz.
UPC
044356227261



SCH507CP Clam Pack
UPC 044356227872

SCH505S SCHRADE® FOLDING KNIFE

9Cr18MoV High Carbon S.S. Blade
G-10 w/Aluminum Handle

- + Dual Thumb Knobs
- + Liner Lock
- + Pocket Clip

Blade Length
3.5" (8.9 cm)
Overall Length
8.1" (20.5 cm)
Weight
5.1 oz.
UPC
044356227247



SCH508 SCHRADE® FOLDING KNIFE

9Cr18MoV High Carbon S.S. Blade
Aluminum Handle

- + Dual Thumb Knobs
- + Liner Lock
- + Index Flipper
- + Pocket Clip

Blade Length
2.9" (7.4 cm)
Overall Length
7.0" (17.7 cm)
Weight
3.6 oz.
UPC
044356227216



SCH217 SCHRADE® FOLDING KNIFE

9Cr18MoV High Carbon Stainless Steel Blade
Coarse Coated Aluminum Handle

- + Dual Thumb Knobs
- + Liner Lock
- + Index Flipper
- + Pocket Clip

Blade Length
2.9" (7.3 cm)
 Overall Length
6.6" (16.8 cm)
 Weight
2.6 oz.
 UPC
044356223157



SCHRADE®
ULTRA GLIDE SERIES



BALL BEARING PIVOT PIN TECH ALLOWS FOR ULTRA SMOOTH OPENING



SCH217L SCHRADE® FOLDING KNIFE

9Cr18MoV High Carbon Stainless Steel Blade
Coarse Coated Aluminum Handle

- + Dual Thumb Knobs
- + Liner Lock
- + Index Flipper
- + Pocket Clip

Blade Length
3.6" (9.2 cm)
 Overall Length
8.4" (21.3 cm)
 Weight
4.6 oz.
 UPC
044356223164



SCH305 SCHRADE® ULTRA GLIDE FOLDING KNIFE

NEW

9Cr18MoV High Carbon Stainless Steel Blade
Stainless Steel w/G-10 Handle

- + Dual Thumb Knobs
- + Liner Lock
- + Pocket Clip

Blade Length
3.5" (8.9 cm)
 Overall Length
8.2" (20.8 cm)
 Weight
5.3 oz.
 UPC
044356228992



SCH305CP Clam Pack
 UPC 044356229111



SCH218 SCHRADE® FOLDING KNIFE

Stonewashed 9Cr18MoV High Carbon S.S. Blade
Stonewashed Aluminum Handle

- + Dual Thumb Knobs
- + Liner Lock
- + Index Flipper
- + Pocket Clip

Blade Length
2.9" (7.3 cm)
 Overall Length
6.6" (16.9 cm)
 Weight
3.0 oz.
 UPC
044356223171



SCH306 SCHRADE® ULTRA GLIDE FOLDING KNIFE

NEW

9Cr18MoV High Carbon Stainless Steel Blade
Aluminum Handle

- + Dual Thumb Knobs
- + Liner Lock
- + Pocket Clip

Blade Length
3.5" (8.8 cm)
 Overall Length
8.1" (20.7 cm)
 Weight
5.2 oz.
 UPC
044356229074



SCH306CP Clam Pack
 UPC 044356229128



SCHRADE®

SCH311 SCHRADE® FOLDING KNIFE

**9Cr18MoV High Carbon Stainless Steel Blade
Stainless Steel Handle**

- + Dual Thumb Knobs
- + Frame Lock
- + Pocket Clip

Blade Length
3.3" (8.4 cm)
Overall Length
7.9" (19.9 cm)
Weight
5.8 oz.
UPC
044356223218



SCH311CP Clam Pack
UPC 044356223751

SCH301 SCHRADE® FOLDING KNIFE

**9Cr18MoV Titanium Coated High Carbon S.S. Blade
Titanium Coated Stainless Steel Handle**

- + Dual Thumb Knobs
- + Frame Lock
- + Index Flipper
- + Pocket Clip

Blade Length
3.7" (9.3 cm)
Overall Length
8.6" (21.8 cm)
Weight
10.6 oz.
UPC
044356217361



SCH303M

- + Dual Thumb Knobs
- + Frame Lock
- + Pocket Clip

Blade Length
2.6" (6.6 cm)
Overall Length
6.0" (15.2 cm)
Weight
2.5 oz.
UPC
044356219693



SCH303MCP Clam Pack
UPC 044356219709



SCH303MS

- + Dual Thumb Knobs
- + Frame Lock
- + Pocket Clip

Blade Length
2.6" (6.6 cm)
Overall Length
6.0" (15.2 cm)
Weight
2.5 oz.
UPC
044356219716



SCH304M

- + Dual Thumb Knobs
- + Frame Lock
- + Pocket Clip

Blade Length
2.6" (6.6 cm)
Overall Length
6.0" (15.2 cm)
Weight
2.5 oz.
UPC
044356219730



SCH304

- + Dual Thumb Knobs
- + Frame Lock
- + Pocket Clip

Blade Length
3.7" (9.3 cm)
Overall Length
8.5" (21.6 cm)
Weight
9.7 oz.
UPC
044356217422



**9Cr18MoV Titanium Coated High Carbon S.S. Blade
Titanium Coated S.S. Handle**



**TITANIUM
SERIES**

SCHRADE®

EXCEPTIONAL EDGE RETENTION // CORROSION RESISTANT
HIGHEST STRENGTH-TO-WEIGHT RATIO OF ANY METAL

SCH600TI SCHRADE® TITANIUM FOLDING KNIFE

**D2 Titanium Coated High Carbon S.S. Blade
Titanium Handle**

- + Dual Thumb Knobs
- + Frame Lock
- + Index Flipper
- + Pocket Clip

Blade Length
3.4" (8.6 cm)
Overall Length
8.0" (20.3 cm)
Weight
5.3 oz.
UPC
044356220057



SCH601TI SCHRADE® TITANIUM FOLDING KNIFE

**D2 Titanium Coated High Carbon S.S. Blade
Titanium Handle**

- + Dual Thumb Knobs
- + Frame Lock
- + Index Flipper
- + Pocket Clip

Blade Length
3.4" (8.6 cm)
Overall Length
8.0" (20.3 cm)
Weight
5.3 oz.
UPC
044356220071



SCH602TI SCHRADE® TITANIUM FOLDING KNIFE

**D2 Titanium Coated High Carbon S.S. Blade
Titanium Handle**

- + Dual Thumb Knobs
- + Frame Lock
- + Pocket Clip
(Additional Clip for Tip-Up Carry)

Blade Length
3.5" (8.9 cm)
Overall Length
7.9" (19.9 cm)
Weight
4.8 oz.
UPC
044356223959



Tip-Down Carry



Tip-Up Carry

SCH603TI SCHRADE® TITANIUM FOLDING KNIFE

**D2 Titanium Coated High Carbon S.S. Blade
Titanium Handle**

- + Dual Thumb Knobs
- + Frame Lock
- + Pocket Clip
(Additional Clip for Tip-Up Carry)

Blade Length
3.5" (8.9 cm)
Overall Length
7.9" (19.9 cm)
Weight
4.8 oz.
UPC
044356223966



Tip-Down Carry



Tip-Up Carry

SCHRADE[®]
FIXED BLADES



SCHRADE®

SAE-1070 High Carbon Steel Blade & Handle

- + Waterproof Hollow Handle
- + Interchangeable Magnetic Tipped Tool
- + Ballistic Sheath

Removable Magnetic Bit Set

- + 1 - Bit Holder
- + 1 - T-Bar
- + 3 - Star Drive Screw Bits (ST10, ST15, ST20)
- + 1 - Hex Key Bit, 5/64"
- + 3 - Slotted Screw Bits (1/4", 3/16", 3/23")
- + 3 - Phillips Screw Bits (PH0, PH1, PH2)



SCHRADE®

SAE-1070 High Carbon Steel Blade & Handle

- + Waterproof Hollow Handle
- + Interchangeable Magnetic Tipped Tool
- + Ballistic Sheath

Removable Magnetic Bit Set

- + 1 - Bit Holder
- + 1 - Star Drive Screw Bit (ST10)
- + 1 - Hex Key Bit, ST10
- + 3 - Slotted Screw Bits (1/8", 5/32", 3/32")
- + 1 - Phillips Screw Bits (PH0)



SCHF1 SCHRADE® EXTREME SURVIVAL®

Blade Length
7.5" (19.0 cm)
Overall Length
12.7" (32.3 cm)
Weight
1 lb. 1.8 oz.
UPC
044356202329



SCHF2 SCHRADE® EXTREME SURVIVAL®

Blade Length
7.5" (19.0 cm)
Overall Length
12.7" (32.3 cm)
Weight
1 lb. 1.8 oz.
UPC
044356202336



SCHFISM SCHRADE® EXTREME SURVIVAL®

Blade Length
5.6" (14.2 cm)
Overall Length
10.3" (26.1 cm)
Weight
12.5 oz.
UPC
044356207652



SCHF2SM SCHRADE® EXTREME SURVIVAL®

Blade Length
5.6" (14.2 cm)
Overall Length
10.3" (26.1 cm)
Weight
12.5 oz.
UPC
044356207669



SCHF21 SCHRADE® EXTREME SURVIVAL®

SAE-1070 High Carbon Steel Blade & Handle

- + Glass Breaker
- + Waterproof Hollow Handle
- + Glass Filled Nylon Boot/Belt Sheath

Blade Length
4.5" (11.4 cm)
Overall Length
9.0" (22.8 cm)
Weight
5.1 oz.
UPC
044356219518
No Ship CA, NY, MA



SCHF22 SCHRADE® EXTREME SURVIVAL®

SAE-1070 High Carbon Steel Blade & Handle

- + Glass Breaker
- + Waterproof Hollow Handle
- + Glass Filled Nylon Boot/Belt Sheath

Blade Length
4.5" (11.4 cm)
Overall Length
9.0" (22.8 cm)
Weight
5.8 oz.
UPC
044356219532



SCHF41 SCHRADE® EXTREME SURVIVAL®

SAE-1070 High Carbon Steel Blade & Handle

- + Glass Breaker
- + Waterproof Hollow Handle
- + Leather & Polyester M.O.L.L.E. Compatible Sheath

Blade Length
6.9" (17.5 cm)
Overall Length
12.0" (30.5 cm)
Weight
12.9 oz.
UPC
044356222747
No Ship CA, NY, MA



SCHF53BS SCHRADE® FIXED BLADE

**AUS-8 Steel Blade
TPE Handle**

- + Full Tang
- + M.O.L.L.E. Compatible Glass-Filled Nylon Sheath

Blade Length
3.4" (8.7 cm)
Overall Length
8.2" (20.8 cm)
Weight
3.7 oz.
UPC
044356225595



SCHF63B SCHRADE® FIXED BLADE

NEW

**AUS-8 Steel Blade
TPE Handle**

- + Full Tang
- + M.O.L.L.E. Compatible Glass-Filled Nylon Sheath

Blade Length
3.5" (8.8 cm)
Overall Length
8.1" (20.7 cm)
Weight
3.6 oz.
UPC
044356228527

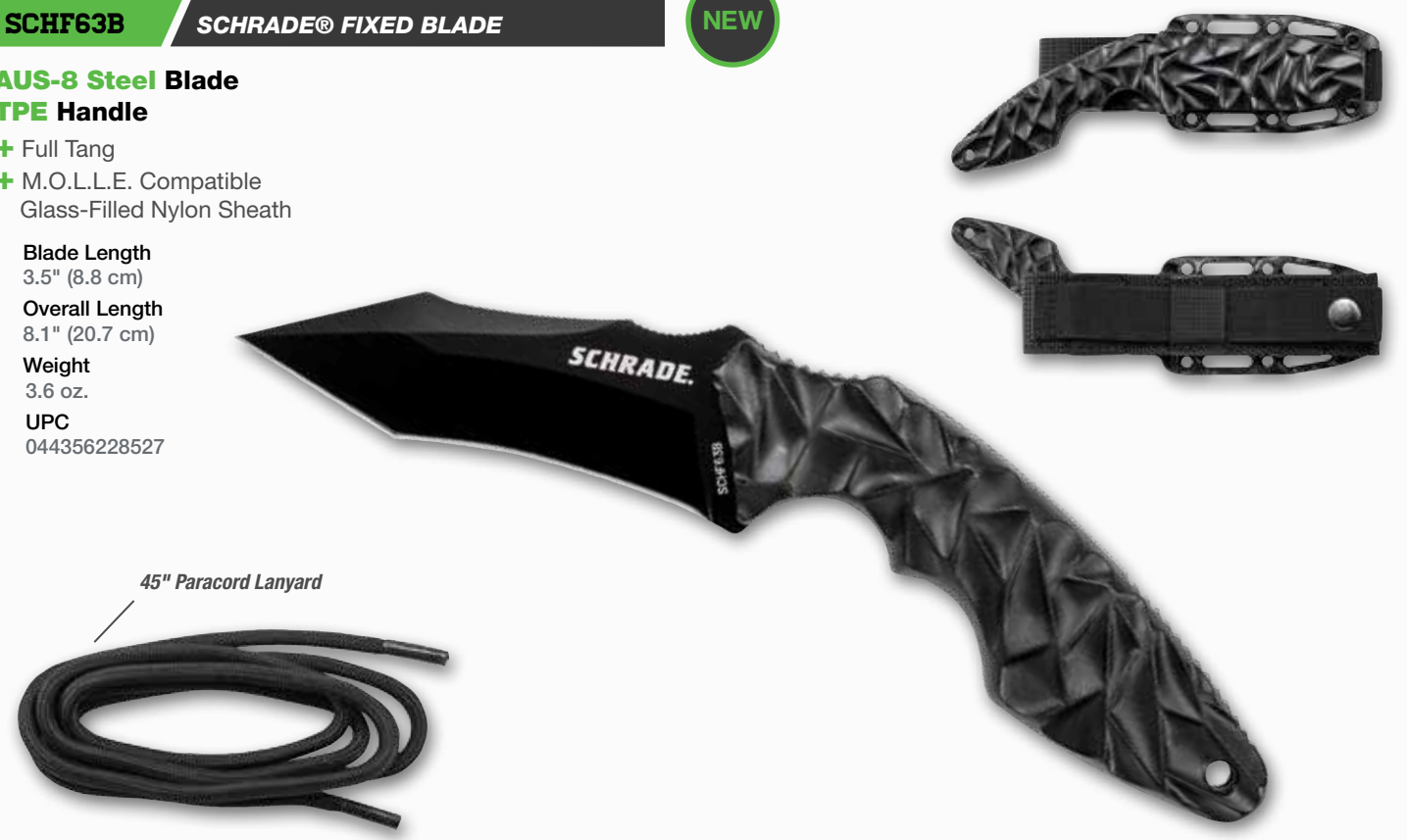

SCHRADER®

SCHF40 SERIES

SK5 High Carbon Steel Blade
Glass-Filled Nylon w/TPE Overmold Handle

- + M.O.L.L.E. Compatible Sheath w/Ballistic Nylon Belt Loop
- + Sharpening Stone (Back of Sheath)
- + Metal Butt Cap



SCHF40 SCHRADER® FIXED BLADE

Blade Length
5.1" (12.9 cm)
 Overall Length
11.0" (27.9 cm)
 Weight
11.5 oz.
 UPC
044356222587



SCHF40L SCHRADER® FIXED BLADE

Blade Length
7.9" (19.9 cm)
 Overall Length
13.8" (34.9 cm)
 Weight
13.8 oz.
 UPC
044356222594



SCHF40D SCHRADER® FIXED BLADE

Blade Length
5.1" (12.9 cm)
 Overall Length
11.0" (27.9 cm)
 Weight
11.5 oz.
 UPC
044356225762



SCHF40LD SCHRADER® FIXED BLADE

Blade Length
7.9" (19.9 cm)
 Overall Length
13.8" (34.9 cm)
 Weight
13.8 oz.
 UPC
044356225779



SCHF6 SCHRADER® M-9 BAYONET

420J2 Powder Coated S.S. Blade
TPR Handle

- + Scabbard Sheath
- + Sharpening Stone (Back of Sheath)
- + Open Drain Hole

Blade Length
8.0" (20.3 cm)
Overall Length
13.0" (33.0 cm)
Weight
13.2 oz.
UPC
044356206051
No Ship CA, NY, MA



SCHF3 SCHRADER® EXTREME SURVIVAL®

8Cr13MoV High Carbon S.S. Blade
Micarta Handle

- + Full Tang
- + Ballistic Sheath

Blade Length
6.4" (16.2 cm)
Overall Length
12.0" (30.4 cm)
Weight
1 lb. 6.0 oz.
UPC
044356203029



SCHF6B SCHRADER® M-9 BAYONET

420J2 Powder Coated S.S. Blade
TPR Handle

- + Scabbard Sheath
- + Sharpening Stone (Back of Sheath)
- + Open Drain Hole

Blade Length
8.0" (20.3 cm)
Overall Length
13.0" (33.0 cm)
Weight
13.2 oz.
UPC
044356219006
No Ship CA, NY, MA



SCHF3N SCHRADER® EXTREME SURVIVAL®

8Cr13MoV High Carbon S.S. Blade
Micarta Handle

- + Full Tang
- + Ballistic Sheath

Blade Length
6.4" (16.2 cm)
Overall Length
12.0" (30.4 cm)
Weight
1 lb. 6.0 oz.
UPC
044356207393



SCHF61 SCHRADER® FIXED BLADE

**8Cr13MoV High Carbon S.S. Blade
Micarta Handle**

- + Full Tang
- + Ballistic Belt Sheath

Blade Length
4.1" (10.5 cm)
Overall Length
8.7" (22.1 cm)
Weight
6.9 oz.
UPC
044356227704



SCHF61CP Clam Pack
UPC 044356227971



SCHF36 SCHRADER® FRONTIER®

**Powder Coated 1095 High Carbon S.S. Blade
TPE Handle**

- + Full Tang
- + Polyester Belt Sheath

Blade Length
5.0" (12.8 cm)
Overall Length
10.4" (26.4 cm)
Weight
12.3 oz.
UPC
044356222556



SCHF36CP Clam Pack
UPC 044356225557



Ferro Rod & Sharpening Stone Included

SCHF36M SCHRADER® FRONTIER®

**Powder Coated 8Cr13MoV High Carbon S.S. Blade
Micarta Handle**

- + Full Tang
- + Polyester Belt Sheath

Blade Length
5.0" (12.8 cm)
Overall Length
10.4" (26.4 cm)
Weight
13.4 oz.
UPC
044356222914



Ferro Rod & Sharpening Stone Included

SCHF37 SCHRADER® FRONTIER®

**Powder Coated 1095 High Carbon S.S. Blade
TPE Handle**

- + Full Tang
- + Polyester Belt Sheath

Blade Length
7.0" (17.8 cm)
Overall Length
12.4" (31.4 cm)
Weight
14.5 oz.
UPC
044356222563



Ferro Rod & Sharpening Stone Included

SCHF37M SCHRADER® FRONTIER®

**Powder Coated 8Cr13MoV High Carbon S.S. Blade
Micarta Handle**

- + Full Tang
- + Polyester Belt Sheath

Blade Length
7.0" (17.8 cm)
Overall Length
12.4" (31.4 cm)
Weight
15.9 oz.
UPC
044356222921



Ferro Rod & Sharpening Stone Included

SCHF38 SCHRADER® FRONTIER®

**Powder Coated 1095 High Carbon S.S. Blade
TPE Handle**

- + Full Tang
- + Polyester Belt Sheath

Blade Length
5.8" (14.7 cm)
Overall Length
11.2" (28.3 cm)
Weight
13.4 oz.
UPC
044356222570



Ferro Rod & Sharpening Stone Included

SCHF51M SCHRADE® FRONTIER®

**1095 High Carbon Stainless Steel Blade
Micarta Handle**

- + Full Tang
- + Polyester Belt Sheath

Blade Length
5.1" (12.8 cm)
Overall Length
10.9" (27.6 cm)
Weight
14.6 oz.
UPC
044356225748



Ferro Rod & Sharpening Stone Included

SCHF51 SCHRADE® FRONTIER®

**1095 High Carbon Steel Blade
TPE Handle**

- + Full Tang
- + Polyester Belt Sheath

Blade Length
5.1" (12.8 cm)
Overall Length
10.9" (27.6 cm)
Weight
13.5 oz.
UPC
044356225182



Ferro Rod & Sharpening Stone Included

SCHF52M SCHRADE® FRONTIER®

**1095 High Carbon Stainless Steel Blade
Micarta Handle**

- + Full Tang
- + Polyester Belt Sheath

Blade Length
7.0" (17.9 cm)
Overall Length
13.0" (33.0 cm)
Weight
1 lb. 1.4 oz.
UPC
044356225755



Ferro Rod & Sharpening Stone Included

SCHF52 SCHRADE® FRONTIER®

**1095 High Carbon Steel Blade
TPE Handle**

- + Full Tang
- + Polyester Belt Sheath

Blade Length
7.0" (17.9 cm)
Overall Length
13.0" (33.0 cm)
Weight
1.0 lb.
UPC
044356225199



Ferro Rod & Sharpening Stone Included

SCHRADER® FRONTIER®

1095 High Carbon Blade Grivory Handle

- + Full Tang
- + Leather Sheath



SCHF55 SCHRADER® FRONTIER®

Blade Length
3.6" (9.0 cm)
Overall Length
7.6" (19.4 cm)
Weight
6.0 oz.
UPC
044356226424



SCHF42 SCHRADER® FRONTIER®

Blade Length
5.1" (13.0 cm)
Overall Length
10.0" (25.3 cm)
Weight
9.5 oz.
UPC
044356223973



SCHF42D SCHRADER® FRONTIER®

Blade Length
5.1" (13.0 cm)
Overall Length
10.0" (25.3 cm)
Weight
9.5 oz.
UPC
044356225786



SCHF26 SCHRADER® EXTREME SURVIVAL®

**8Cr13MoV High Carbon S.S. Blade
TPE Handle**

- + Full Tang
- + Polyester Belt Sheath

Blade Length
5.4" (13.7 cm)
Overall Length
10.8" (27.4 cm)
Weight
13.6 oz.
UPC
044356220002



SCHF26CP Clam Pack
UPC 044356219990



SCHF9 SCHRADER® EXTREME SURVIVAL®

**1095 High Carbon Stainless Steel Blade
TPE Handle**

- + Full Tang
- + Ballistic Sheath

Blade Length
6.4" (16.3 cm)
Overall Length
12.1" (30.7 cm)
Weight
15.7 oz.
UPC
044356207201



SCHF9CP Clam Pack
UPC 044356216913



SCHF9N SCHRADER® EXTREME SURVIVAL®

**8Cr13MoV High Carbon Stainless Steel Blade
TPE Handle**

- + Full Tang
- + Ballistic Sheath

Blade Length
6.4" (16.3 cm)
Overall Length
12.1" (30.7 cm)
Weight
15.5 oz.
UPC
044356220552



SCHF28 SCHRADE® LITTLE RICKY™

Titanium Coated 8Cr13MoV High Carbon S.S. Blade
TPE Handle

- + Full Tang
- + Thermoplastic Belt Sheath

Blade Length
7.9" (20.2 cm)
Overall Length
14.1" (35.7 cm)
Weight
1 lb. 4.8 oz.
UPC
044356222235



SCHF45 SCHRADE® LEROY®

Titanium Coated 8Cr13MoV High Carbon S.S. Blade
TPE Handle

- + Full Tang
- + Thermoplastic Belt Sheath

Blade Length
10.4" (26.3 cm)
Overall Length
16.5" (41.9 cm)
Weight
1 lb. 7.6 oz.
UPC
044356224796



SCHRADE®
JETHRO™

Titanium Coated 8Cr13MoV High Carbon S.S. Blade
TPE Handle

- + Full Tang
- + Thermoplastic Belt Sheath



SCHF48 SCHRADE® JETHRO™

Blade Length 11.9" (30.2 cm) Weight 1 lb. 9.9 oz.
Overall Length 18.0" (45.8 cm) UPC 044356225205

SCHF56M SCHRADE® FIXED BLADE

NEW

**1095 High Carbon Steel Blade
Micarta Handle**

- + Full Tang
- + Thermoplastic Belt Sheath

Blade Length
3.4" (8.7 cm)
Overall Length
8.2" (20.9 cm)
Weight
8.4 oz.
UPC
044356228602



Built-in Ferro Rod Holder
w/Ferro Rod



SCHF56LM SCHRADE® FIXED BLADE

NEW

**1095 High Carbon Steel Blade
Micarta Handle**

- + Full Tang
- + Thermoplastic Belt Sheath

Blade Length
4.4" (11.1 cm)
Overall Length
9.2" (23.3 cm)
Weight
9.3 oz.
UPC
044356228619



Built-in Ferro Rod Holder
w/Ferro Rod



SCHF56 SCHRADE® FIXED BLADE

**1095 High Carbon Steel Blade
TPE Handle**

- + Full Tang
- + Polyester Belt Sheath

Blade Length
3.5" (8.8 cm)
Overall Length
8.2" (20.9 cm)
Weight
7.8 oz.
UPC
044356227278



Built-in Ferro Rod Holder
w/Ferro Rod



SCHF56L SCHRADE® FIXED BLADE

**1095 High Carbon Steel Blade
TPE Handle**

- + Full Tang
- + Polyester Belt Sheath

Blade Length
4.4" (11.1 cm)
Overall Length
9.1" (23.2 cm)
Weight
8.4 oz.
UPC
044356227674



Built-in Ferro Rod Holder
w/Ferro Rod



SCHRADE®

PREMIUM LEATHER SHEATHS ALSO AVAILABLE

LS56 (For SCHRADE® SCHF56)	LS56L (For SCHRADE® SCHF56L)
Overall Length 8.2" (20.8 cm)	Overall Length 9.2" (23.3 cm)
Weight 3.1 oz.	Weight 3.2 oz.
UPC 044356228558	UPC 044356228565

+ LS56

+ LS56L



SCHF57 SCHRADER® FIXED BLADE

65Mn High Carbon Steel Blade G-10 Handle

- + Full Tang
- + Thermoplastic Belt Sheath
Compatible w/FR4 Removable Ferro Rod Attachment

Blade Length
2.6" (6.7 cm)
Overall Length
6.3" (15.9 cm)
Weight
4.0 oz.
UPC
044356227285



FERRO ROD ATTACHMENT

FR4 (Sold Separately) UPC 044356227780



SCHF58 SCHRADER® FIXED BLADE

65Mn High Carbon Steel Blade G-10 Handle

- + Full Tang
- + Thermoplastic Belt Sheath
w/Removable Ferro Rod Attachment

Blade Length
3.5" (8.8 cm)
Overall Length
8.1" (20.5 cm)
Weight
6.7 oz.
UPC
044356227292



*Removable
Ferro Rod Attachment
w/Ferro Rod*



SCHF59 SCHRADER® FIXED BLADE

65Mn High Carbon Steel Blade G-10 Handle

- + Full Tang
- + Thermoplastic Belt Sheath
w/Removable Ferro Rod Attachment

Blade Length
3.8" (9.7 cm)
Overall Length
8.4" (21.3 cm)
Weight
6.2 oz.
UPC
044356227308



*Removable
Ferro Rod Attachment
w/Ferro Rod*



SCHF59CP Clam Pack
UPC 044356227636

SCHF49 SCHRADE® FIXED BLADE

8Cr13MoV High Carbon Stainless Steel Blade
TPE Handle

- + Full Tang
- + Thermoplastic Sheath

Blade Length
4.1" (10.4 cm)
Overall Length
9.4" (23.9 cm)
Weight
6.9 oz.
UPC
044356225236



SCHF32 SCHRADE® FIXED BLADE

8Cr13MoV High Carbon Stainless Steel Blade
TPE Handle

- + Full Tang
- + Thermoplastic Sheath

Blade Length
4.2" (10.7 cm)
Overall Length
9.4" (23.9 cm)
Weight
7.4 oz.
UPC
044356222204



SCHF32CP Clam Pack
UPC 044356224307

SCHF30 SCHRADE® FIXED BLADE

8Cr13MoV High Carbon Stainless Steel Blade
TPE Handle

- + Full Tang
- + Thermoplastic Sheath

Blade Length
4.9" (12.5 cm)
Overall Length
9.7" (24.6 cm)
Weight
6.3 oz.
UPC
044356222501



SCHF33 SCHRADE® FIXED BLADE

8Cr13MoV High Carbon Stainless Steel Blade
TPE Handle

- + Full Tang
- + Thermoplastic Sheath

Blade Length
4.5" (11.4 cm)
Overall Length
9.1" (23.2 cm)
Weight
7.1 oz.
UPC
044356222136



SCHF31 SCHRADE® FIXED BLADE

8Cr13MoV High Carbon S.S. Blade TPE Handle

- + Full Tang
- + Thermoplastic Sheath

Blade Length
4.5" (11.4 cm)
Overall Length
9.7" (24.7 cm)
Weight
7.6 oz.
UPC
044356224376



SCHF31CP Clam Pack
UPC 044356224437

SCHF31GH SCHRADE® FIXED BLADE

8Cr13MoV High Carbon S.S. Blade TPE Handle

- + Full Tang
- + Thermoplastic Sheath

Blade Length
4.5" (11.4 cm)
Overall Length
9.7" (24.7 cm)
Weight
7.6 oz.
UPC
044356224932



SCHF31S SCHRADE® FIXED BLADE

8Cr13MoV High Carbon S.S. Blade TPE Handle

- + Full Tang
- + Thermoplastic Sheath

Blade Length
4.5" (11.4 cm)
Overall Length
9.7" (24.7 cm)
Weight
7.6 oz.
UPC
044356224949



SCHF66 SCHRADE® FIXED BLADE



7Cr17MoV High Carbon Stainless Steel Blade TPR Handle

- + Full Tang
- + Polyester Belt Sheath

Blade Length
2.9" (7.4 cm)
Overall Length
6.4" (16.3 cm)
Weight
3.2 oz.
UPC
044356229913

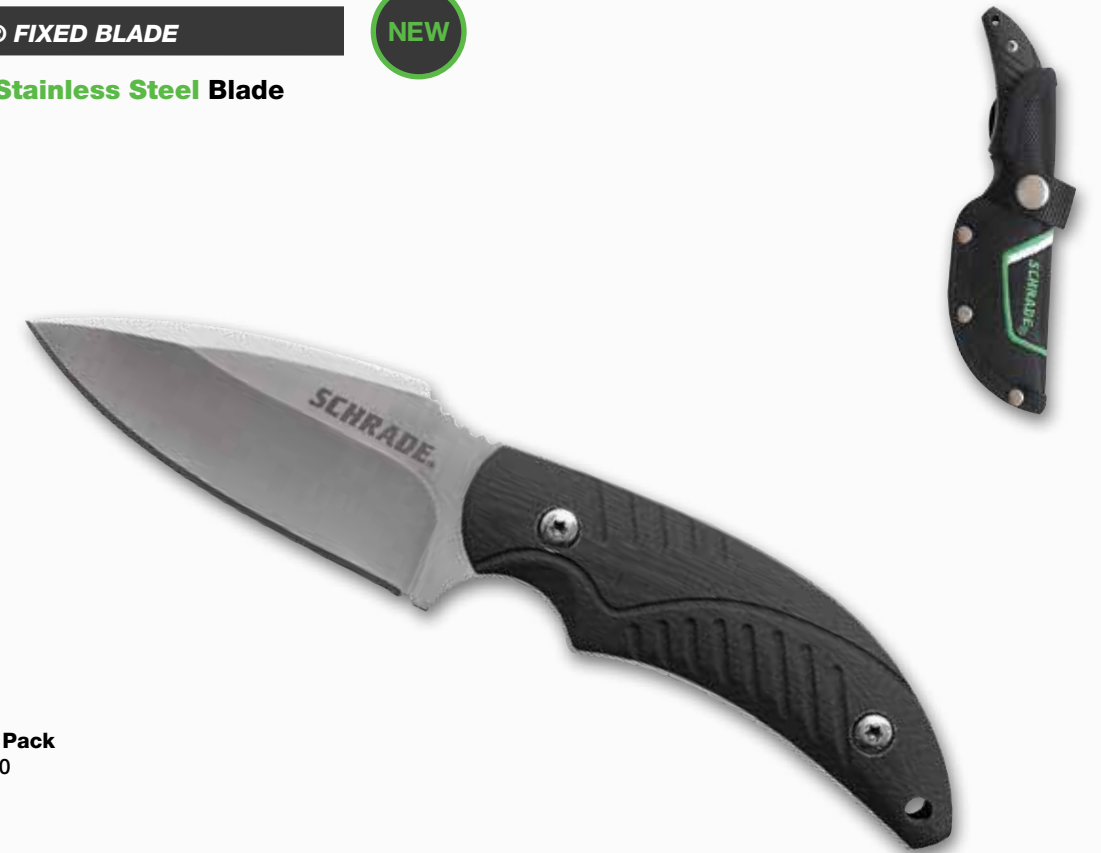

SCHF66CP Clam Pack
UPC 044356229920

SCHRADE® GUIDE MASTER®

8Cr13MoV Steel Blade TPE Handle

- + Full Tang Knife & Slingshot
RST (Replacement Slingshot Tube) UPC 044356226042
- + Built-In 120 & 600 Grit Sharpening Stones
- + Removable Ferro Rod
FR3 (Replacement Ferro Rod) UPC 044356226059
- + Six - 12mm Ball Bearing Shots
- + Twin Locking Key Feature
- + ABS Sheath w/Storage Compartment



SPRING LOADED AMMO MAGAZINE



REMOVABLE FERRO ROD



SCHF39CP Clam Pack
UPC 044356226028



SCHF39 SCHRADE® FIXED BLADE W/SLINGSHOT

Blade Length	5.2" (13.3 cm)	Weight	8.8 oz.
Overall Length	10.5" (26.6 cm)	UPC	044356222761

SCHRADE®

Titanium Coated 8Cr13MoV High Carbon S.S. Blade TPE Handle

- + Full Tang
- + Pry Tool Locking Pin/Lanyard
- + Multiple Carry Option Nylon Filled Glass Fiber Sheath

Titanium Coated 3Cr13 S.S. Pry Tool

- + 4.5" (11.4 cm) Overall Length
- + Flat Head Screwdriver
- + Strap Cutter
- + Bottle Opener
- + 1/4" Hex Wrench
- + Wrench Driver

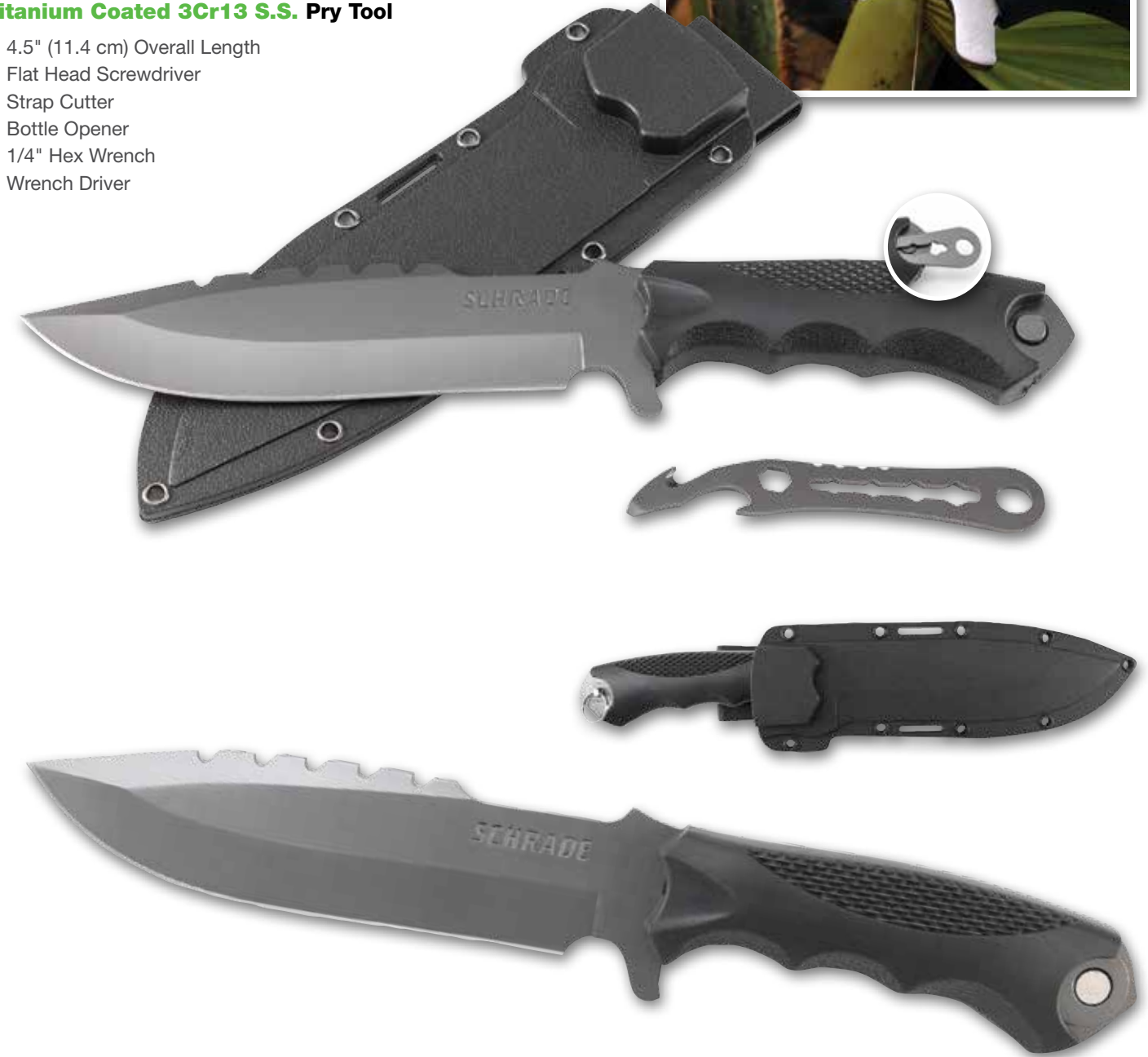

SCHF27 SCHRADE® FIXED BLADE

Blade Length	6.6" (16.7 cm)	Weight	9.9 oz.
Overall Length	11.5" (29.2 cm)	UPC	044356221160

SCH111 SCHRADE® KARAMBIT NECK KNIFE

9Cr18MoV High Carbon Stainless Steel Blade

- + Full Tang Neck Knife
- + Thermoplastic Sheath

Blade Length
3.0" (7.5 cm)
Overall Length
6.3" (16.1 cm)
Weight
2.3 oz.
UPC
044356226431



*Designed by
Joshua Waggoner*

INTEGRATED FINGER HOLE FOR MULTIPLE GRIP POSITIONS



SCH112 SCHRADE® SHASTA MC'NASTY™

8Cr13MoV High Carbon Stainless Steel Blade
TPE Handle

- + Full Tang
- + Dual Edged Blade
- + Thermoplastic Sheath

Blade Length
5.2" (13.2 cm)
Overall Length
8.4" (21.3 cm)
Weight
8.2 oz.
UPC
044356226448
No Ship CA, NY, MA



*Designed by
Joshua Waggoner*

SCH110 SCHRADE® FOLDING KARAMBIT

9Cr18MoV High Carbon S.S. Blade
G-10 Handle

- + Dual Thumb Knobs
- + Liner Lock
- + Pocket Clip
(Additional Clip for Tip-Up Carry)

Blade Length
3.2" (8.0 cm)
Overall Length
7.8" (19.7 cm)
Weight
6.3 oz.
UPC
044356222259



Training Version Available Page 131

SCHF54 / **PUSH DAGGER**

8Cr13MoV High Carbon S.S. Blade
TPE Handle

- + Full Tang
- + Multi-Carry Option Nylon Fiber Sheath

Blade Length
3.2" (8.2 cm)
Overall Length
6.5" (16.4 cm)
Weight
2.7 oz.
UPC
044356226387
No Ship CA, NY, MA



Multi-Carry Option Nylon Fiber Sheath



Training Version Available Page 130

SCHF50 / **KEYCHAIN DAGGER**

9Cr18MoV High Carbon S.S. Blade
TPE Handle

- + Fully Serrated/Fine Edge Spear Point Blade
- + T-Handle w/Palm Jimping
- + ABS Neck Sheath w/Carabiner Clip

Blade Length
1.3" (3.2 cm)
Overall Length
2.8" (7.0 cm)
Weight
0.5 oz.
UPC
044356225137
No Ship CA, NY, MA



Actual Size



SCHF50FCP False Edge
UPC 044356227193 Clam Pack

SCHCC1 / **CREDIT CARD KNIFE**

NEW

8Cr13MoV High Carbon S.S. Blade

- + Full Tang
- + Thermoplastic Belt Sheath/Money Clip

Blade Length
1.9" (4.8 cm)
Overall Length
3.6" (9.1 cm)
Weight
1.0 oz.
UPC
044356226240

SCHCC1CP Clam Pack
UPC 044356230520

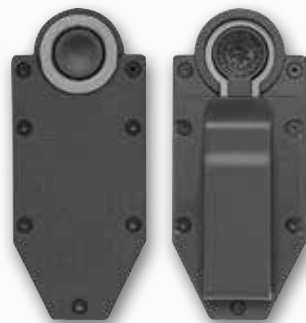

Actual Size

SCHF46 / **NECK KNIFE**

9Cr18MoV High Carbon S.S. Blade

- + Full Tang Neck Knife
- + 550 Paracord Wrapped Handle
- + Nylon Fiber Neck Sheath

Blade Length
2.4" (6.2 cm)
Overall Length
6.0" (15.2 cm)
Weight
1.9 oz.
UPC
044356225212



SCHF46TAS / **NECK KNIFE**

9Cr18MoV High Carbon S.S. Blade

- + Full Tang Neck Knife
- + 550 Paracord Wrapped Handle
- + Nylon Fiber Neck Sheath

Blade Length
2.4" (6.2 cm)
Overall Length
6.0" (15.2 cm)
Weight
1.9 oz.
UPC
044356224826



SCHF47TA / **NECK KNIFE**

9Cr18MoV High Carbon S.S. Blade

- + Full Tang Neck Knife
- + 550 Paracord Wrapped Handle
- + Nylon Fiber Neck Sheath

Blade Length
2.7" (6.7 cm)
Overall Length
6.0" (15.2 cm)
Weight
2.3 oz.
UPC
044356224833



SCHF60 SCHRADE® NECK KNIFE/TOOL

AUS-8 High Carbon S.S. Blade

- + Full Tang Neck Knife
- + Metric & Standard Ruler
- + Wrench Sizes: 1/2, 7/16, 3/8, 5/16, 1/4
- + Oxygen Wrench
- + Size 14 & 15 Bicycle Spoke Wrench
- + Bottle Opener
- + Nylon Fiber Neck Sheath w/Breakaway Chain & Pocket Clip

Blade Length
2.3" (5.9 cm)
Overall Length
5.5" (13.9 cm)
Weight
1.0 oz.
UPC
044356227384



Actual Size

Only use tool when knife is in sheath



SCHF16 SCHRADE® NECK KNIFE

**9Cr18MoV High Carbon Stainless Steel Blade
G-10 Handle**

- + Full Tang Neck Knife
- + Lanyard Hole
- + Thermoplastic Sheath

Blade Length
3.1" (7.8 cm)
Overall Length
7.0" (17.7 cm)
Weight
4.6 oz.
UPC
044356217460



SCHF55M SCHRADE® MINI NECK KNIFE

7Cr17MoV High Carbon S.S. Blade

- + Full Tang Neck Knife
- + Lanyard Hole
- + Bottle Opener
- + Neck Sheath w/Breakaway Chain

Blade Length
2.1" (5.2 cm)
Overall Length
4.3" (11.0 cm)
Weight
0.7 oz.
UPC
044356224505



Actual Size

SCHF5N SCHRADE® EXTREME SURVIVAL®

7Cr17MoV High Carbon S.S. Blade

- + Full Tang Neck Knife
- + Lanyard Hole
- + Bottle Opener
- + Neck Sheath w/Pocket Clip

Blade Length
3.1" (7.8 cm)
Overall Length
6.6" (16.7 cm)
Weight
1.8 oz.
UPC
044356209267



SCHF5SN SCHRADE® EXTREME SURVIVAL®

7Cr17MoV High Carbon S.S. Blade

- + Full Tang Neck Knife
- + Lanyard Hole
- + Bottle Opener
- + Neck Sheath w/Pocket Clip

Blade Length
3.1" (7.8 cm)
Overall Length
6.6" (16.7 cm)
Weight
1.8 oz.
UPC
044356209274





SCHRADE® WATER RAT®

WR3 SCHRADE® WATER RAT®

7Cr17MoV High Carbon Stainless Steel Blade Phosphorescence TPR Handle

- + Full Tang w/Lanyard Hole
- + Line Cutter
- + PP Vest/Belt/Leg Sheath w/Open Drain Hole

Blade Length
4.7" (11.9 cm)
Overall Length
9.4" (23.8 cm)
Weight
4.4 oz.
UPC
044356220583
No Ship CA, NY, MA



Partial Saw

Highly Visable Handle

Vest Attachments Included



WR2 SCHRADE® WATER RAT®

8Cr13MoV High Carbon Stainless Steel Blade TPE Handle

- + Full Tang w/Lanyard Hole
- + Line Cutter
- + Nylon Filled Glass Fiber Sheath

Blade Length
3.2" (8.1 cm)
Overall Length
6.9" (17.5 cm)
Weight
2.8 oz.
UPC
044356217262
No Ship CA, NY, MA



Double Edged Spear Point Blade



WR4 SCHRADE® WATER RAT®

8Cr13MoV High Carbon Stainless Steel Blade TPE Handle

- + Full Tang w/Lanyard Hole
- + Line Cutter
- + Nylon Filled Glass Fiber Sheath

Blade Length
3.2" (8.1 cm)
Overall Length
6.9" (17.5 cm)
Weight
3.0 oz.
UPC
044356227728
No Ship CA, NY, MA



Double Edged Flat Tip Blade



SCHF44LS / **SCHRADE® NEEDLE™ BOOT KNIFE**

7Cr17MoV High Carbon S.S. Blade TPE Handle

- + Lanyard Hole
- + Leather Sheath with Boot/Belt Clip

Blade Length
7.6" (19.4 cm)
Overall Length
12.7" (32.2 cm)
Weight
5.1 oz.
UPC
044356224840
No Ship CA, NY, MA



SCHF19L / **SCHRADE® LARGE BOOT KNIFE**

7Cr17MoV High Carbon S.S. Blade TPE Handle

- + Lanyard Hole
- + Leather Sheath with Boot/Belt Clip

Blade Length
4.8" (12.2 cm)
Overall Length
9.0" (22.9 cm)
Weight
4.1 oz.
UPC
044356219457
No Ship CA, NY, MA



Training Version Available Page 130

SCHF19 / **SCHRADE® SMALL BOOT KNIFE**

7Cr17MoV 7 High Carbon S.S. Blade TPE Handle

- + Lanyard Hole
- + Leather Sheath w/Belt & Boot Clip

Blade Length
3.6" (9.1 cm)
Overall Length
7.0" (17.7 cm)
Weight
2.1 oz.
UPC
044356219464
No Ship CA, NY, MA



SCHF19HP / **SCHRADE® SMALL BOOT KNIFE**

7Cr17MoV 7 High Carbon S.S. Blade TPE Handle

- + Lanyard Hole
- + Leather Sheath w/Belt & Boot Clip

Blade Length
3.6" (9.1 cm)
Overall Length
7.0" (17.7 cm)
Weight
2.1 oz.
UPC
044356222112
No Ship CA, NY, MA (SCHF19HP only)



SCHF19HPF False Edge
UPC 044356222129
SCHF19HPFCP False Edge
UPC 044356221894 Clam Pack

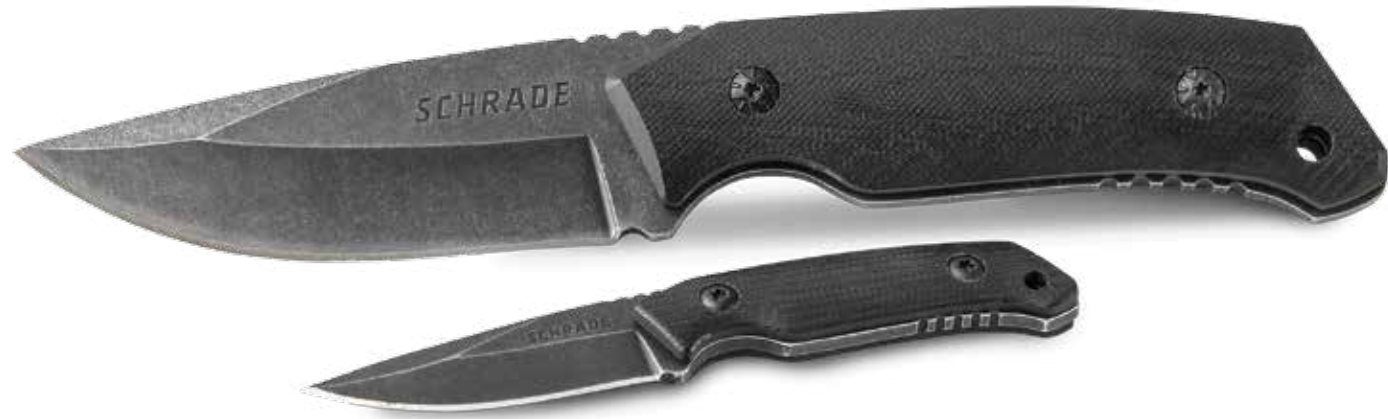

SCHF13SM SCHRADE® MINI NECK KNIFE

Stone Washed 8Cr13MoV High Carbon S.S. Blade
G-10 Handle

- + Full Tang
- + Lanyard Hole
- + Kydex® Neck Sheath w/Breakaway Chain

Blade Length
2.1" (5.2 cm)
Overall Length
4.7" (12.0 cm)
Weight
1.4 oz.
UPC
044356224420



SCHF13 SCHRADE® FIXED BLADE

Stone Washed 8Cr13MoV High Carbon S.S. Blade
G-10 Handle

- + Full Tang
- + Lanyard Hole
- + Multiple Carry Option Kydex® Belt Sheath

Blade Length
3.7" (9.4 cm)
Overall Length
8.5" (21.6 cm)
Weight
7.4 oz.
UPC
044356217217



SCHF14 SCHRADE® FIXED BLADE

Stone Washed 8Cr13MoV High Carbon S.S. Blade
G-10 Handle

- + Full Tang
- + Multiple Carry Option Kydex® Sheath

Blade Length
3.4" (8.6 cm)
Overall Length
7.9" (20.0 cm)
Weight
5.6 oz.
UPC
044356217224



SCHF14CP Clam Pack
UPC 044356217866



SCHF15 SCHRADE® FIXED BLADE

Stone Washed 8Cr13MoV High Carbon S.S. Blade
G-10 Handle

- + Full Tang
- + Multiple Carry Option Kydex® Sheath

Blade Length
3.4" (8.6 cm)
Overall Length
7.9" (20.0 cm)
Weight
6.0 oz.
UPC
044356217231



SCHF35 SCHRADE® FIXED BLADE

**Stone Washed 8Cr13MoV High Carbon S.S. Blade
G-10 Handle**

- + Full Tang
- + Multiple Carry Option Kydex® Sheath

Blade Length
3.4" (8.6 cm)
Overall Length
8.0" (20.3 cm)
Weight
6.7 oz.
UPC
044356222167



SCHF20 SCHRADE® FIXED BLADE

**Stone Washed 8Cr13MoV High Carbon S.S. Blade
G-10 Handle**

- + Full Tang
- + Multiple Carry Option Kydex® Belt Sheath

Blade Length
4.4" (11.2 cm)
Overall Length
8.5" (21.6 cm)
Weight
5.5 oz.
UPC
044356219495
No Ship CA, NY, MA



SCHF24 SCHRADE® FIXED BLADE

**Stone Washed 8Cr13MoV High Carbon S.S. Blade
G-10 Handle**

- + Full Tang
- + Multiple Carry Option Kydex® Belt Sheath

Blade Length
3.4" (8.6 cm)
Overall Length
8.0" (20.3 cm)
Weight
6.5 oz.
UPC
044356220231



SCTK3CP SCHRADE® THROWING KNIVES

Stone Washed 2Cr13MoV High Carbon S.S.

- + 3 - Full Tang Throwing Knives
- + 3 - Paper Targets Included
- + Polyester Sheath

Overall Length
10.0" (25.5 cm)
Individual Weight
4.2 oz.
UPC
044356224710
No Ship CA, NY, MA

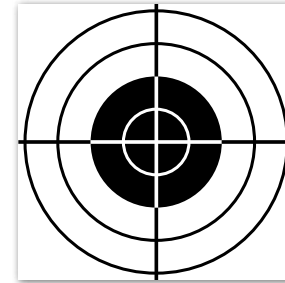

SCTK6CP SCHRADE® THROWING KNIVES

Stone Washed 2Cr13MoV High Carbon S.S.

- + 6 - Full Tang Throwing Knives
- + 3 - Paper Targets Included
- + Polyester Sheath

Overall Length
8.0" (20.3 cm)
Individual Weight
2.6 oz.
UPC
044356224727
No Ship CA, NY, MA

*Sheath Separates For Two Individual,
3 PC Carry Sets*



THROWING KNIVES

Only available in clam pack

SCHBOLO / **SCHRADE® BOLO FIXED BLADE**

Titanium Coated TICN 3Cr13 Stainless Steel Blade
Safe-T-Grip® Handle

- + Lanyard Hole
- + Polyester Sheath w/Removable Storage Pouch
Shoulder Strap/Leg Straps/Belt Loop

Blade Length
14.0" (35.5 cm)
Overall Length
20.2" (51.2 cm)
Weight
1 lb. 10.8 oz.
UPC
044356216814



SCHBOLOCP Clam Pack
UPC 044356217880

Ferro Rod & Sharpening Stone Included

SCHRADE®
KUKRI MACHETE

Powder Coated 3Cr13 Stainless Steel Blade
Safe-T-Grip® Handle

- + Ferro Rod
- + Sharpening Stone
- + Lanyard Hole
- + Polyester Sheath w/Removable Storage Pouch
Shoulder Strap/Leg Straps/Belt Loop



SCHKMISM / **SCHRADE® KUKRI MACHETE**

Blade Length
9.9" (25.1 cm)
Overall Length
15.1" (38.3 cm)
Weight
12.3 oz.
UPC
044356220576

SCHKM1SMCP Clam Pack
UPC 044356220606

Ferro Rod & Sharpening Stone Included

SCHMBSCP / **SCHRADE® PRISCILLA BRUSH SWORD**



Powder Coated 3Cr13 Stainless Steel Blade
TPE Handle

- + Full Tang
- + Thermoplastic Sheath
w/Shoulder Strap

Blade Length
16.1" (40.8 cm)
Overall Length
22.6" (57.5 cm)
Weight
19.8 oz.
UPC
044356229609

Only available in clam pack
Designed by Joshua Waggoner



SCHKMI / **SCHRADE® KUKRI MACHETE**

Blade Length
13.3" (33.8 cm)
Overall Length
19.7" (50.0 cm)
Weight
1 lb. 6.6 oz.
UPC
044356220545

SCHKM1CP Clam Pack
UPC 044356220590

Ferro Rod & Sharpening Stone Included



SCHGK1 SCHRADE® GURKHA KUKRI

3Cr13MoV Stainless Steel Blade TPE Handle

- + Lanyard Hole
- + Polyester Sheath w/Removable Shoulder Strap/ Leg Strap/Belt Loop

Blade Length
12.8" (32.5 cm)
Overall Length
18.3" (46.5 cm)
Weight
15.9 oz.
UPC
044356225229



SCHGK1CP Clam Pack
UPC 044356227339



SCHPRICP SCHRADE® PARANG MACHETE

NEW

3Cr13 Stainless Steel Blade TPE Handle

- + Full Tang
- + Polyester Sheath w/Removable Shoulder Strap/ Leg Strap/Belt Loop

Blade Length
13.7" (34.8 cm)
Overall Length
19.6" (49.8 cm)
Weight
21.3 oz.
UPC
044356228732



SCHF43 SCHRADE® JESSICA X FIXED BLADE

DESIGNED BY CHRIS TANNER

1070 High Carbon Steel Blade TPE Handle

- + Versatile Handle Design For Multiple Grip Positions
- + Lanyard Hole
- + Polyester Sheath w/Removable Shoulder Strap/ Leg Strap/Belt Loop

Blade Length
9.0" (22.9 cm)
Overall Length
17.5" (44.5 cm)
Weight
1 lb. 12.0 oz.
UPC
044356224208

**BATONING
CHOPPING
FEATHERING**

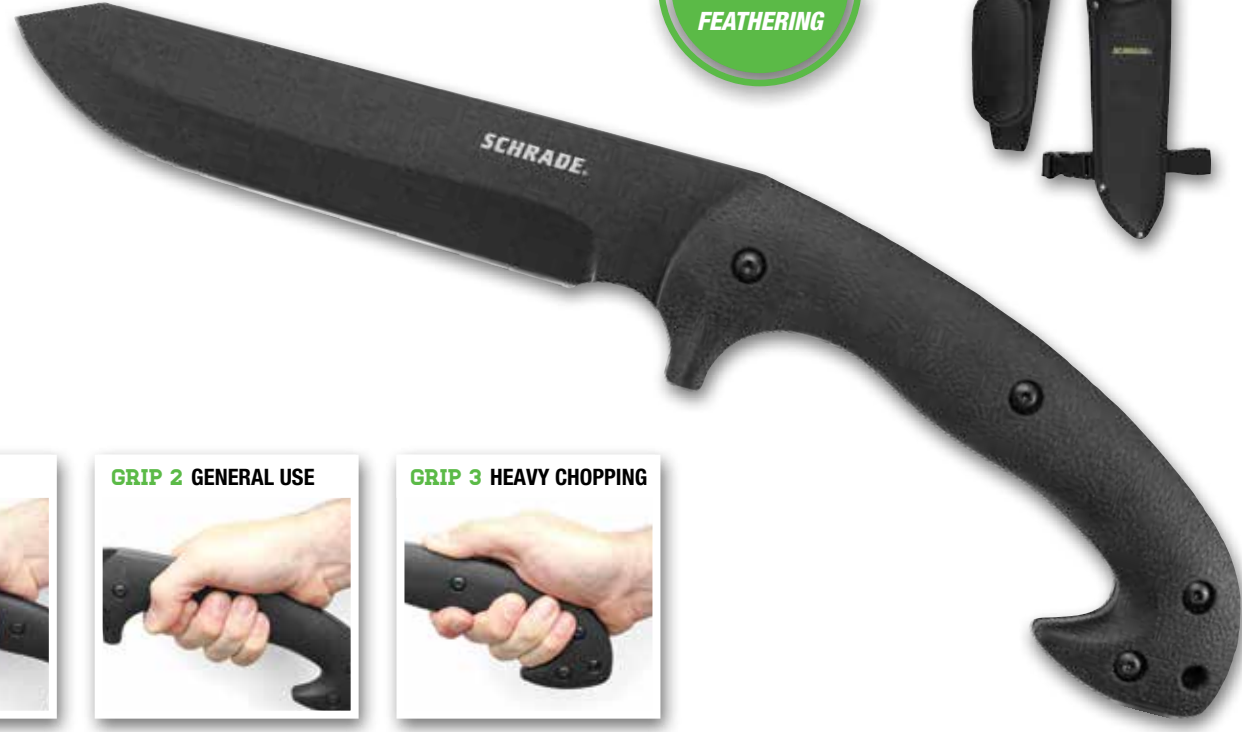

SCHF64CP SCHRADE® FROE FIXED BLADE

NEW

1070 High Carbon Steel Blade TPE Handle

- + Full Tang
- + Polyester Belt Sheath w/Leg Strap

Blade Length
8.5" (21.6 cm)
Overall Length
14.7" (37.4 cm)
Weight
15.6 oz.
UPC
044356229043

Only available in clam pack



SCMACH1CP SCHRADE® MACHETE

3Cr13 Stainless Steel Blade TPR Handle

- + Full Tang
- + Lanyard Hole
- + Polyester Belt Sheath

Blade Length
12.0" (30.5 cm)
Overall Length
18.3" (46.4 cm)
Weight
13.2 oz.
UPC
044356224987

Only available in clam pack



SCMACH2CP SCHRADE® MACHETE

3Cr13 Stainless Steel Blade TPR Handle

- + Full Tang
- + Lanyard Hole
- + Polyester Belt Sheath

Blade Length
14.9" (37.7 cm)
Overall Length
20.9" (53.1 cm)
Weight
15.3 oz.
UPC
044356224994

Only available in clam pack

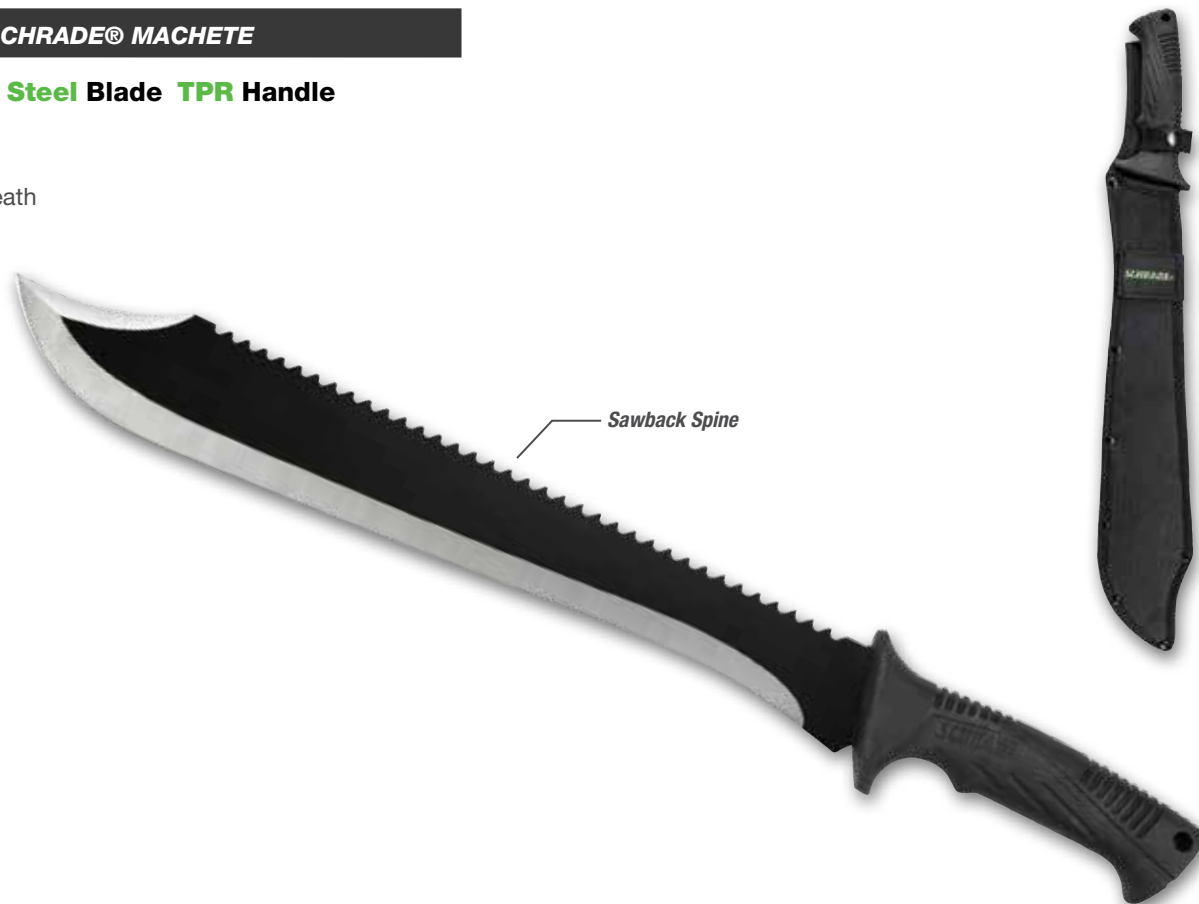

SCHRADE®
OUTBACK® MACHETE

3Cr13 Stainless Steel Blade Polypropylene Handle

- + Full Tang
- + D Handle Guard
- + Lanyard Hole
- + Olive Drab Military Style Belt Sheath w/Built-In Sharpener



SCMACH18CP SCHRADE® OUTBACK® MACHETE

Blade Length
12.5" (31.7 cm)
Overall Length
18.0" (45.7 cm)
Weight
1 lb. 13.1 oz.
UPC
044356217897

Only available in clam pack



SCMACH22CP SCHRADE® OUTBACK® MACHETE

Blade Length
16.5" (41.9 cm)
Overall Length
22.0" (55.9 cm)
Weight
2 lb. 3.1 oz.
UPC
044356217903

Only available in clam pack



FULLY EXTENDING SAW BLADE



**Titanium Coated 3Cr13 S.S. Blade
Glass Fiber Filled PA & TPR Handle**

- + 12.5" Fully Extending Saw Blade (Stores in Handle)
- + Polyester Belt Sheath



SCAXE9CP
Clam Pack
UPC 044356224246



SCAXE9	SCHRADE® AXE/SAW		
Blade Length	3.3" (8.3 cm)	Weight	2 lb. 1.3 oz.
Overall Length	18.0" (45.9 cm)	UPC	044356223041



**Titanium Coated 3Cr13 Stainless Steel Blade
Glass Fiber Filled PA & TPR Rubber Material +
Cold Resistance Flexibilizer Handle**

- + Dual Grit Round Disc Sharpening Stone
- + Ferro Rod (Stores In Shaft)
- + Polyester Belt Sheath



SCAXE2LCP
Clam Pack
UPC 044356220958



SCAXE2L	SCHRADE® LARGE SURVIVAL AXE		
Blade Length	4.2" (10.6 cm)	Weight	1 lb. 15.0 oz.
Overall Length	15.7" (39.9 cm)	UPC	044356220941



TITANIUM-COATED BLADE.
BOMB-PROOF HANDLE. BECAUSE THERE IS

**NO SUCH THING
AS OVERKILL.**

SCHRADE®

SCAXE2 Series Features

Titanium Coated 3Cr13 Stainless Steel Blade
Glass Fiber Filled PA & TPR Rubber Material
& Cold Resistance Flexibilizer Handle

- + Ferro Rod (Stores in Shaft)
- + Phosphorescence Handle (SCAXE2G Only)
- + Thermoplastic Belt Sheath



SCAXE2CP
Clam Pack
UPC 044356217873



SCAXE2 / **SCHRADE® HATCHET**

Blade Length	3.8" (9.6 cm)	Weight	1 lb. 6.4 oz.
Overall Length	11.8" (30.0 cm)	UPC	044356216821



SCAXE2GCP
Clam Pack
UPC 044356219792



SCAXE2G / **SCHRADE® HATCHET**

Blade Length	3.8" (9.6 cm)	Weight	1 lb. 12.4 oz.
Overall Length	11.8" (30.0 cm)	UPC	044356219143



SCAXE2O / **SCHRADE® HATCHET**

Blade Length	3.8" (9.6 cm)	Weight	1 lb. 6.4 oz.
Overall Length	11.8" (30.0 cm)	UPC	044356217781



**3Cr13 Stainless Steel Blade
TPR Handle**

- + Full Tang
- + Hammer Pommel
- + Thermoplastic Belt Sheath



SCAXE10CP Clam Pack
UPC 044356227315



SCAXE10 SCHRADE® HATCHET

Blade Length	3.6" (9.0 cm)	Weight	1 lb. 5.9 oz.
Overall Length	11.1" (28.1 cm)	UPC	044356225502

**SK5 High Carbon Steel Blade
Nylon Fiber Handle**

- + Nail Pull/Pry Bar
- + Spike Pommel
- + Nylon Belt Sheath w/Belt Loop



SCAXE5 SCHRADE® TACTICAL HATCHET

Blade Length	3.1" (7.9 cm)	Weight	1 lb. 9.0 oz.
Overall Length	12.8" (32.5 cm)	UPC	044356220422

SCHCOM6CP HATCHET/MINI MACHETE COMBO



3Cr13 Stainless Steel Blade TPR Handle

- + Full Tang
- + Individual Belt Sheaths

Hatchet

Blade Length
3.6" (9.0 cm)
Overall Length
11.1" (28.1 cm)
Weight
1 lb. 5.9 oz.

Machete

Blade Length
8.5" (21.5 cm)
Overall Length
14.6" (37.0 cm)
Weight
12.0 oz.

Only available in clam pack



SCHCOM6CP Clam Pack
UPC 044356229968



SCSAW1 SCHRADE® FOLDING SAW

3Cr13MoV Stainless Steel Blade Plastic Handle

- + Push Button Lockback
- + Polyester Sheath

Blade Length
7.1" (17.9 cm)
Overall Length
16.2" (41.3 cm)
Weight
7.0 oz.
UPC
044356224925



SCSAW1CP Clam Pack
UPC 044356227322



SCHRADE® PHANTOM® SPEARS

SCHSP1/SCHSP2/SCHSP3 Feature

- 3Cr13 Stainless Steel Blade**
- Nylon Filled Glass Fiber w/Enhance Flexibilizer Shaft**



SURVIVAL KIT

SPEAR EXTENSION HANDLE



THREADED EXTENSION

SCHSP-EXT1

- + Screws Into Butt Cap
 - + 550 Paracord Wrapped Textured Grip
- Overall Length**
15.7" (39.8 cm)
- Weight**
10.9 oz.
- UPC**
044356225281

SCHSP1 SCHRADE® LONG SPEAR

- + Double Edged Blade w/Blood Groove
- + 550 Paracord Wrapped Textured Grips
- + Large Ferro Rod/Survival Kit (Stores in Shaft)
 - + Two Needles
 - + Two Fishing Hooks
 - + Two Split Shots
 - + Fishing Line
- + Nylon Fiber Sheath

Blade Length
7.2" (18.3 cm)

Overall Length
44.5" (113.0 cm)

Weight
2 lb. 9.1 oz.

UPC
044356222648

No Ship CA, NY, MA



SCHSP2 SCHRADE® ARROWHEAD SPEAR

- + Double Edged Blade
- + 550 Paracord Wrapped Textured Grips
- + Large Ferro Rod/Survival Kit (Stores in Shaft)
 - + Two Needles
 - + Two Fishing Hooks
 - + Two Split Shots
 - + Fishing Line
- + Nylon Fiber Sheath

Blade Length
5.2" (13.3 cm)

Overall Length
42.3" (107.4 cm)

Weight
2 lb. 6.4 oz.

UPC
044356222655

No Ship CA, NY, MA



SCHSP3 SCHRADE® LONG FLINT SPEAR

- + Double Edged Blade w/Blood Groove
- + 550 Paracord Wrapped Textured Grips
- + Large Ferro Rod/Survival Kit (Stores in Shaft)
 - + Two Needles
 - + Two Fishing Hooks
 - + Two Split Shots
 - + Fishing Line
- + Nylon Fiber Sheath

Blade Length
7.2" (18.3 cm)

Overall Length
44.5" (113.0 cm)

Weight
2 lb. 9.1 oz.

UPC
04435224321

No Ship CA, NY, MA



IT DIGS. IT CUTS. IT FORTIFIES YOUR
**POSITION ON THE
FOOD CHAIN.**



**RELY
ON YOU**

SCHSH1 / **SCHRADE® TELESCOPING SHOVEL**

**Carbon Steel 1055 Shovel
PP Handle**

- + "T" Handle For Better Leverage
- + 19" Telescoping Handle
- + Sharpened Edges
- + Polyester Sheath

Blade Length
7.4" (18.9 cm)
Overall Length
16.6" (42.1 cm)
Weight
1 lb. 15.7 oz.
UPC
044356223768



Folds For
Easy Storage

- + Powder Coated SK5 High Carbon Stainless Steel
- + Bending Strength: 394 lbf (179 kgf)



550 Paracord
Wrapped Handle

SCHPB1BK / **SCHRADE® PRY BAR**

Overall Length 7.5" (19.1 cm) UPC 044356222433
Weight 4.1 oz.

- + Powder Coated SK5 High Carbon Stainless Steel
- + Bending Strength: 394 lbf (179 kgf)



550 Paracord
Wrapped Handle

SCHPB1OD / **SCHRADE® PRY BAR**

Overall Length 7.5" (19.1 cm) UPC 044356222440
Weight 4.1 oz.

**SCHRADE®
MOE™ MULTI-FUNCTION DEMOLITION TOOL**

- + Bending Strength: 1,843 lbf (836 KGF)
- + 550 Paracord Wrapped Handle
- + Nail Pull/Pry Bar (Each End)
- + Spanner Wrench
- + Fire Axe
- + Hammer
- + Gas Shut-Off Feature
- + Clear Polyvinylchloride Sheath



550 Paracord
Wrapped Handle

Nail Pull/
Pry Bar

Spanner
Wrench

Gas Shut-Off Feature

Fire Axe

Hammer

Pry Bar

Nail Pull

SCHPB2BK / **MOE™ DEMOLITION TOOL**

Steel 1055 High Carbon Steel Weight 2 lb. 5.2 oz.
Overall Length 16.8" (42.7 cm) UPC 044356224772

- + Strap Cutter
- + Bottle Opener
- + Flat Head Screw Driver
- + Pry Tip
- + Scraper End
- + Wrench Driver Accommodates 5/16", 3/8", 7/16", 1/2", 9/16"
- + Lanyard or Keychain Hole
- + Anti-Scratch Stonewashed Finish
- + 1/4" Hex Wrench



SCTPT KEYCHAIN PRY TOOL

Steel 6AL-4V Titanium
 Overall Length 3.2" (8.2 cm)
 Weight 0.5 oz.
 UPC 044356211543

- + Strap Cutter
- + Bottle Opener
- + Flat Head Screw Driver
- + Pry Tip
- + Scraper End
- + Wrench Driver Accommodates 5/16", 3/8", 7/16", 1/2", 9/16" METRIC 5, 6, 8, 10, 13
- + Anti-Scratch Stonewashed Finish
- + 1/4" Hex Wrench



SCTPT2 KEYCHAIN PRY TOOL

Steel 6AL-4V Titanium
 Overall Length 3.4" (8.8 cm)
 Weight 2.6 oz.
 UPC 044356216012

- + Sharpened Hook For Wires/Small Ropes
- + Bottle Opener
- + Scraper, Nail Puller, Flat Screw Driver
- + Pry Section
- + Size 14 & 15 Spoke Wrench On Bikes
- + Wrench Driver Accommodates 1/4", 5/16", 3/8", 7/16", 1/2" METRIC 8, 13
- + Keychain/Lanyard Hole



SCPT1 KEYCHAIN PRY TOOL

Steel 420J2 Steel
 Overall Length 2.9" (7.5 cm)
 Weight 1.0 oz.
 UPC 044356226035

- + Glass Breaker/Punch Point
- + Rescue Hook
- + Oxygen Wrench
- + Pry Tool
- + 1/4" Wrench/Lanyard Hole
- + Flat Screwdriver
- + Polyester Sheath w/Pocket Clip



SCPT2 PERSONAL RESCUE TOOL

Steel 9Cr18MoV High Carbon S.S. Weight 1.6 oz.
 Overall Length 4.4" (11.3 cm) UPC 044356226172

- + Ceramic Glass Breaker/Punch Point
- + Rescue Hook
- + Oxygen Wrench
- + Pry Tool
- + 1/4" Wrench/Lanyard Hole
- + Flat Screwdriver
- + Polyester Sheath w/Pocket Clip



SCPT3 PERSONAL RESCUE TOOL

Steel 8Cr13MoV High Carbon S.S. Weight 2.8 oz.
 Overall Length 5.5" (14.0 cm) UPC 044356228305

ST12

SCHRADE® KEYCHAIN MULTI-TOOL



9 Functions

- + Keychain Lanyard
- + Pliers
- + Wire Stripper
- + Bottle Opener
- + Scissors
- + Screwdriver
- + Phillips Head
- + Tweezers
- + Drop Point Knife

Closed Length 2.6" (6.5 cm)
 Overall Length 4.2" (10.5 cm)
 Weight 2.1 oz.
 UPC 044356229975



ST12CP Clam Pack
 UPC 044356229982

ST12TSACP

SCHRADE® KEYCHAIN MULTI-TOOL



9 Functions

- + Keychain Lanyard
- + Pliers
- + Wire Stripper
- + Bottle Opener
- + Scissors
- + Screwdriver
- + Phillips Head
- + Tweezers
- + File

Closed Length 2.6" (6.5 cm)
 Overall Length 4.2" (10.5 cm)
 Weight 2.1 oz.
 UPC 044356229999

Only available in clam pack



Notice: Before traveling with this product, be sure to check the rules and regulations applicable to your mode of transportation for any restrictions regarding this product.

ST10 SCHRADE® TOUGH MULTI-TOOL

15 Functions

- + Needle Nose Pliers
- + Regular Pliers
- + Wire Cutter
- + Fine Edge Blade
- + Small Phillips Head
- + Can Opener
- + Ruler
- + Fine Grit File
- + Hexagon Wrench - 3 Sizes
- + Large Screwdriver
- + Small Screwdriver
- + Bottle Opener
- + Nail Puller
- + Saw
- + Spring Loaded
- + Molded Polyester Belt Sheath



ST10CP Clam Pack
UPC 044356226226

Steel
Handle Titanium Coated 2Cr13 S.S.
Closed Length 4.2" (10.6 cm)
Overall Length 6.5" (16.5 cm)
Weight 8.6 oz.
UPC 044356227612

ST1N SCHRADE® TOUGH MULTI-TOOL

21 Functions

- + Needle Nose Pliers
- + Regular Pliers
- + Vise
- + Wire Cutter
- + Cap Lifter
- + Can Opener
- + Locking Phillips Screwdriver
- + Scribe
- + Awl
- + Leather Bore
- + Locking Dual Edge Knife Blade
- + Metal File
- + Wood File
- + Measuring Gauge
- + Hook Disgorger
- + Locking Heavy Duty Saw Blade
- + Scraping Blade
- + Wire Strippers
- + Locking Large Flat Screwdriver
- + Fine Flat Head Screwdriver
- + Lanyard Attachment
- + Polyester Belt Sheath

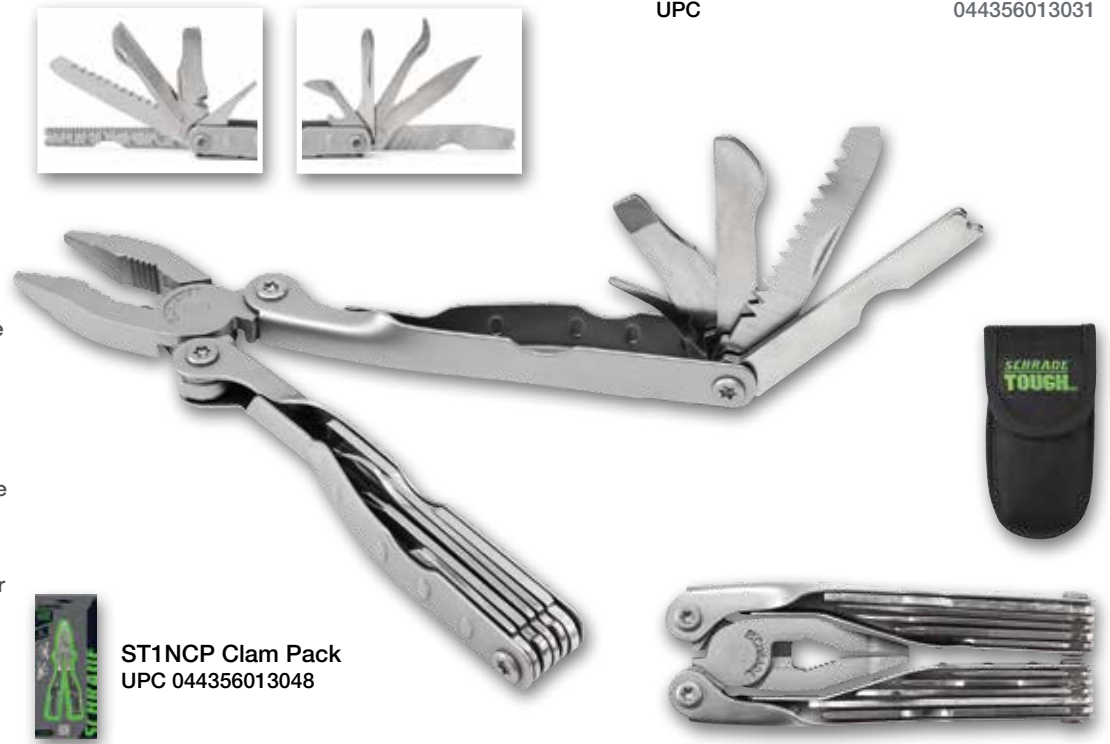

ST1NCP Clam Pack
UPC 044356013048

Steel
Closed Length 4.8" (12.2 cm)
Overall Length 7.0" (17.8 cm)
Weight 8.1 oz.
UPC 044356013031

ST11 SCHRADE® TOUGH MULTI-TOOL

9 Functions

- + Needle Nose Pliers
- + Regular Pliers
- + Wire Cutter
- + Fine Edge Blade
- + Small Phillips Head
- + Small Flat Head
- + Fine Grit File
- + Bottle Opener
- + Heavy Duty Scissors
- + Pocket Clip
- + Molded Polyester Belt Sheath



ST11CP Clam Pack
UPC 044356226479

Steel
Closed Length 4.1" (10.4 cm)
Overall Length 6.2" (15.8 cm)
Weight 6.3 oz.
UPC 044356227605

ST1NB SCHRADE® TOUGH MULTI-TOOL

20 Functions

- + Needle Nose Pliers
- + Regular Pliers
- + Vise
- + Wire Cutter
- + Cap Lifter
- + Can Opener
- + Locking Phillips Screwdriver
- + Scribe
- + Awl
- + Leather Bore
- + Locking Dual Edge Knife Blade
- + Metal File
- + Wood File
- + Heavy Duty Scissors
- + Locking Heavy Duty Saw Blade
- + Scraping Blade
- + Wire Strippers
- + Locking Large Flat Screwdriver
- + Fine Flat Head Screwdriver
- + Lanyard Attachment
- + Polyester Belt Sheath



ST1NB CP Clam Pack
UPC 044356205702

Steel
Closed Length 4.8" (12.2 cm)
Overall Length 7.0" (17.8 cm)
Weight 8.1 oz.
UPC 044356203227

TACTICAL PUSH BUTTON PEN

CNC Machined 6061 T6 Aluminum

- + Pocket Clip
- + Easyflow Schmidt P900M Parker Style
Black Ball Point Cartridge

SCHRADE®

SCPEN9BK SCHRADE® TACTICAL PEN

Overall Length
5.0" (12.8 cm)
Weight
1.6 oz.
UPC
044356222693



SCPEN9BL SCHRADE® TACTICAL PEN

Overall Length
5.0" (12.8 cm)
Weight
1.6 oz.
UPC
044356222938



SCPEN9G SCHRADE® TACTICAL PEN

Overall Length
5.0" (12.8 cm)
Weight
1.6 oz.
UPC
044356222709



TACTICAL PEN

CNC Machined 6061 T6 Aluminum

- + Pocket Clip
- + Schmidt P900 Parker Style
Black Ball Point Cartridge
- Pen Refill
UPC 044356206679

SCHRADE®

SCPENBK SCHRADE® TACTICAL PEN

Overall Length
5.7" (14.5 cm)
Weight
1.4 oz.
UPC
044356208550



SCPENG SCHRADE® TACTICAL PEN

Overall Length
5.7" (14.5 cm)
Weight
1.4 oz.
UPC
044356206655



SCPENP SCHRADE® TACTICAL PEN

Overall Length
5.7" (14.5 cm)
Weight
1.4 oz.
UPC
044356206662



TACTICAL SURVIVAL PEN

CNC Machined 6061 T6 Aluminum

- + Whistle Cap (110 dB)
- + Striker Plate
- + Ferro Rod
 - FR2 (Replacement Ferro Rod)**
 - UPC 044356221443
- + Pocket Clip
- + Black Starminin Fine Point
 - D1 Pen Cartridge
 - Pen Refill 2**
 - UPC 044356217590

SCHRADE®



SCPEN4BK SCHRADE® SURVIVAL PEN

Overall Length
5.9" (15.0 cm)
Weight
1.7 oz.
UPC
044356216128



SCPEN4BR SCHRADE® SURVIVAL PEN

Overall Length
5.9" (15.0 cm)
Weight
1.7 oz.
UPC
044356216159



SCPEN4G SCHRADE® SURVIVAL PEN

Overall Length
5.9" (15.0 cm)
Weight
1.7 oz.
UPC
044356216142



SCPEN4O SCHRADE® SURVIVAL PEN

Overall Length
5.9" (15.0 cm)
Weight
1.7 oz.
UPC
044356216135



SCHRADE® TRAINING KNIVES

USING AN UNSHARPENED TRAINING KNIFE ALLOWS FOR THE USER TO PRACTICE FUNDAMENTAL MOVEMENTS, DRILLS AND VARIOUS TECHNIQUES WITHOUT THE RISK OF CUTTING THEMSELVES OR OTHERS.



SCHF54-TR SCHRADE® TRAINING PUSH DAGGER

NEW

8Cr13MoV High Carbon S.S. Blade
TPE Handle

- + Full Tang
- + Multiple Carry Option
Nylon Fiber Sheath

Blade Length
3.2" (8.2 cm)
Overall Length
6.5" (16.4 cm)
Weight
2.7 oz.
UPC
044356228671



SCHF19L-TR SCHRADE® TRAINING BOOT KNIFE

NEW

7Cr17MoV High Carbon S.S. Blade
TPE Handle

- + Lanyard Hole
- + Leather Sheath
with Boot/Belt Clip

Blade Length
4.7" (11.8 cm)
Overall Length
9.8" (24.9 cm)
Weight
4.2 oz.
UPC
044356228688



SCH110-TR SCHRADE® TRAINING KARAMBIT

NEW

9Cr18MoV High Carbon Stainless Steel Blade
G-10 Handle

- + Dual Thumb Knobs
- + Liner Lock
- + Pocket Clip
(Additional Clip for Tip-Up Carry)

Blade Length
3.2" (8.0 cm)
Overall Length
7.8" (19.7 cm)
Weight
6.3 oz.
UPC
044356228664



SCHF23-TR SCHRADE® TRAINING FIXED BLADE

NEW

8Cr13MoV Stonewashed High Carbon S.S. Blade
G-10 Handle

- + Full Tang
- + Multiple Carry Option
Kydex® Belt Sheath

Blade Length
3.4" (8.6 cm)
Overall Length
8.0" (20.3 cm)
Weight
6.5 oz.
UPC
044356228695



Uncle Henry®

== EVERLASTINGLY SHARP ==



22UH DELUXE WOOD CARVING KIT

NEW

65Mn High Carbon Blades Wood Handle

- + 6SBL Blade Pack of 6 Small Detail Blades
- + 20E x 15/16" Radius Ground on Outside Curve
- + 21EX Straight Blade
- + 11 Straight Blade Ground on Slanted Edge
- + 10 1" Radius Ground on Inside Curve
- + 8 2" Radius Ground on Inside Curve
- + 22 2" Radius Ground on Inside Curve
- + 1 - LD2 1/2" x .05" Heavy Duty Blade
- + 1 - LN3 1/2" x .05" Carving Blade
- + 1 - LS1 1/2" x .05" Carving Blade
- + 1 - LBG #7 Sweep Gouge 5/16" Cut

Handle Length
4.6" (11.7 cm)

Weight
12.8 oz.

UPC
044356228510



- + 7Cr17MoV High Carbon S.S.
- + Drop Point Blade
- + Can Opener
- + Screwdriver & Cap Lifter
- + Awl
- + Shackle
- + Nickel Silver Bolsters

- + 7Cr17MoV High Carbon S.S.
- + Clip Point Blade
- + Fish Scaling Blade
- + Nickel Silver Bolsters

NEW

23UH SCOUT KNIFE

Blade Length 2.4" (6.2 cm) **Weight** 3.5 oz.
Overall Length 6.1" (15.5 cm) **UPC** 044356228497

NEW

1UH FISH KNIFE

Blade Length 3.3" (8.4 cm) **Weight** 2.9 oz.
Overall Length 7.6" (19.4 cm) **UPC** 044356228848

- + 7Cr17MoV High Carbon S.S.
- + Sheepsfoot Blade (2)
- + Pen Blade
- + Coping Blade
- + Nickel Silver Bolsters

- + 7Cr17MoV High Carbon S.S.
- + Spear Point Blade
- + Coping Blade
- + Pen Blade
- + Nickel Silver Bolsters

4UH MASTER

Blade Length 2.3" (5.8 cm) **Weight** 2.6 oz.
Overall Length 5.8" (14.7 cm) **UPC** 044356000437

9UH CIGAR WHITTILER

Blade Length 2.8" (7.1 cm) **Weight** 2.3 oz.
Overall Length 6.7" (17.0 cm) **UPC** 044356000611



GRIP A LEGEND

WHEN SEARCHING FOR A LEGENDARY KNIFE, LOOK NO FURTHER THAN WHAT THE EXPERIENCED TRADESMEN CARRIES IN HIS POCKET. LEGENDARY UNCLE HENRY® MODELS SUCH AS OUR HANDSOMELY CRAFTED TRADITIONAL STAGLON® FOLDERS, FIXED BLADES AND SELECT SERIES LOCKBACKS GIVE YOU TRADITIONAL STYLE WITH RUGGED DEPENDABILITY.

- + 7Cr17MoV High Carbon S.S.
- + Clip Point Blade
- + Sheepsfoot Blade
- + Pen Blade
- + Nickel Silver Bolsters



807UH JUNIOR

Blade Length 2.0" (5.1 cm) Weight 1.1 oz.
Overall Length 4.8" (12.2 cm) UPC 044356003162

- + 7Cr17MoV High Carbon S.S.
- + Clip Point Blade
- + Sheepsfoot Blade
- + Pen Blade
- + Nickel Silver Bolsters



834UH RANCHER®

Blade Length 2.5" (6.4 cm) Weight 1.8 oz.
Overall Length 5.8" (14.7 cm) UPC 044356003193

- + 7Cr17MoV High Carbon S.S.
- + Clip Point Blade
- + Gut Hook
- + Lockblade
- + Nickel Silver Bolsters



877UH MUSKRAT GUTHOOK

Blade Length 3.0" (7.6 cm) Weight 2.8 oz.
Overall Length 7.0" (17.8 cm) UPC 044356208574

- + 7Cr17MoV High Carbon S.S.
- + Drop Point Blade
- + Pen Blade
- + Nickel Silver Bolsters
- + Leather Sheath



11UH LARGE CANOE

Blade Length 2.5" (6.4 cm) Weight 2.5 oz.
Overall Length 6.1" (15.5 cm) UPC 044356209168

- + 7Cr17MoV High Carbon S.S.
- + Clip Point Blade
- + Sheepsfoot Blade
- + Spey Blade
- + Nickel Silver Bolsters



885UH SENIOR RANCHER

Blade Length 3.0" (7.6 cm) UPC 044356003049
Overall Length 6.9" (17.5 cm) **885UHCP CLAM PACK**
Weight 2.8 oz. UPC 044356003322

- + 7Cr17MoV High Carbon S.S.
- + Clip Point Blade
- + Pen Blade
- + Shackle
- + Nickel Silver Bolsters



804UH JOURNEYMAN

Blade Length 2.0" (5.1 cm) Weight 1.1 oz.
Overall Length 4.8" (12.2 cm) UPC 044356003506

- + 7Cr17MoV High Carbon S.S.
- + Pen Blade
- + Scissors
- + Nickel Silver Bolsters



707UH GAMBLER

Blade Length 1.7" (4.3 cm) Weight 1.2 oz.
Overall Length 4.5" (11.4 cm) UPC 044356003230

- + 7Cr17MoV High Carbon S.S.
- + Drop Point Blade
- + Clip Point Blade
- + Nickel Silver Bolsters
- + Leather Sheath



227UH FOLDING BOWIE

Blade Length 4.0" (10.2 cm) Weight 6.7 oz.
Overall Length 9.3" (23.6 cm) UPC 044356201704

- + 7Cr17MoV High Carbon S.S.
- + Clip Point Blade
- + Sheepsfoot Blade
- + Spey Blade
- + Nickel Silver Bolsters



897UH PREMIUM STOCK

Blade Length 2.8" (7.1 cm) UPC 044356003056
Overall Length 6.2" (15.7 cm) **897UHCP CLAM PACK**
Weight 2.1 oz. UPC 044356014168

- + 7Cr17MoV High Carbon S.S.
- + Clip Point Blade
- + Sheepsfoot Blade
- + Spey Blade
- + Stainless Steel Bolsters



897UHP PREMIUM STOCK

Blade Length 2.8" (7.1 cm) Weight 2.3 oz.
Overall Length 6.2" (15.7 cm) UPC 044356212830

- + 7Cr17MoV High Carbon S.S.
- + Clip Point Blade
- + Lockblade
- + Nickel Silver Bolsters



197UH CAT PAW

Blade Length 2.8" (7.1 cm) Weight 1.9 oz.
Overall Length 6.3" (16.0 cm) UPC 044356226127

- + 7Cr17MoV High Carbon S.S.
- + Clip Point Blade
- + Spey Blade
- + Nickel Silver Bolsters



285UH PRO TRAPPER

Blade Length 3.2" (8.1 cm) UPC 044356003025
Overall Length 7.0" (17.8 cm) **285UHCP CLAM PACK**
Weight 2.8 oz. UPC 044356203128

- + 7Cr17MoV High Carbon S.S.
- + Clip Point Blade
- + Shackle
- + Nickel Silver Bolsters



12UH ROADIE

Blade Length 2.2" (5.6 cm) UPC 044356003247
 Overall Length 5.1" (13.0 cm) **12UHCP CLAM PACK**
 Weight 0.9 oz. UPC 044356003308

- + 7Cr17MoV High Carbon S.S.
- + Clip Point Blade
- + Lanyard Hole
- + Nickel Silver Bolsters
- + Leather Sheath



124UH TRADESMAN®

Blade Length 3.1" (7.9 cm) Weight 2.5 oz.
 Overall Length 7.1" (18.0 cm) UPC 044356209403

- + 7Cr17MoV High Carbon S.S.
- + Drop Point Blade
- + Lockback
- + Nickel Silver Bolsters



5UH BRUIN

Blade Length 2.8" (7.1 cm) UPC 044356021364
 Overall Length 6.5" (16.5 cm) **5UHCP CLAM PACK**
 Weight 2.6 oz. UPC 044356021357

- + 7Cr17MoV High Carbon S.S.
- + Drop Point Blade
- + Lockblade
- + Nickel Silver Bolsters



55UH SPECIAL EDITION BRUIN

Blade Length 2.8" (7.0 cm) Weight 3.0 oz.
 Overall Length 6.5" (16.5 cm) UPC 044356209397

- + 7Cr17MoV High Carbon S.S.
- + Hawkbill Blade
- + Nickel Silver Bolsters



16UH HAWKBILL PRUNER

Blade Length 3.0" (7.6 cm) Weight 3.4 oz.
 Overall Length 7.0" (17.8 cm) UPC 044356210256

- + 7Cr17MoV High Carbon S.S.
- + Clip Point Blade
- + Shackle
- + Lockback
- + Nickel Silver Bolsters



LB2 SMOKEY

Blade Length 1.5" (3.8 cm) Weight 1.1 oz.
 Overall Length 3.8" (9.7 cm) UPC 044356014090

LB1 CUB

7Cr17MoV High Carbon S.S. Blade Wood Handle

- + Clip Point Blade
- + Shackle
- + Lockback
- + Nickel Silver Bolsters

Blade Length 1.5" (3.8 cm)
 Overall Length 3.8" (9.7 cm)
 Weight 1.1 oz.
 UPC 044356014007



Actual Size

Uncle Henry®
 —EVERLASTINGLY SHARP—

LB3 BROWN BEAR

7Cr17MoV High Carbon S.S. Blade Wood Handle

- + Clip Point Blade
- + Lockback
- + Nickel Silver Bolsters

Blade Length 2.2" (5.6 cm)
 Overall Length 5.1" (13.0 cm)
 Weight 1.6 oz.
 UPC 044356014014



LB3CP Clam Pack
 UPC 044356014182



Actual Size

LB5 SMOKEY

7Cr17MoV High Carbon S.S. Blade Wood Handle

- + Clip Point Blade
- + Lockback
- + Nickel Silver Bolsters
- + Leather Sheath

Blade Length 2.8" (7.1 cm)
 Overall Length 6.5" (16.5 cm)
 Weight 3.1 oz.
 UPC 044356014021



LB5CP Clam Pack
 UPC 044356014199



Uncle Henry®

== EVERLASTINGLY SHARP ==

LB7 BEAR PAW

7Cr17MoV High Carbon S.S. Blade Wood Handle

- + Clip Point Blade
- + Lockback
- + Brass Bolsters
- + Leather Sheath

Blade Length
3.7" (9.4 cm)
Overall Length
8.7" (22.1 cm)
Weight
7.6 oz.
UPC
044356014038



LB7CP Clam Pack
UPC 044356014151



LB8 PAPA BEAR

7Cr17MoV High Carbon S.S. Blade Staglon® Handle

- + Clip Point Blade
- + Lockback
- + Brass Bolsters
- + Leather Sheath

Blade Length
3.7" (9.4 cm)
Overall Length
8.7" (22.1 cm)
Weight
6.9 oz.
UPC
044356224901



LB8CP Clam Pack
UPC 044356227377



185UH UNCLE HENRY® GUT HOOK

NEW

7Cr17MoV High Carbon Stainless Steel Blade Staglon® Handle

- + Full Tang
- + Brass Guard
- + Leather Belt Sheath

Blade Length
4.3" (10.8 cm)
Overall Length
9.1" (23.0 cm)
Weight
7.8 oz.
UPC
044356229647



185UHCP Clam Pack
UPC 044356229654



186UH UNCLE HENRY® GUT HOOK

NEW

7Cr17MoV High Carbon Stainless Steel Blade Staglon® Handle

- + Full Tang
- + Brass Guard
- + Leather Belt Sheath

Blade Length
4.0" (10.1 cm)
Overall Length
8.4" (21.3 cm)
Weight
6.9 oz.
UPC
044356229661



182UH ELK HUNTER® DROP POINT

**7Cr17MoV High Carbon Stainless Steel Blade
Staglon® Handle**

- + Full Tang
- + Brass Guard & Pommel
- + Leather Belt Sheath

Blade Length
3.8" (9.7 cm)
Overall Length
8.4" (21.4 cm)
Weight
6.3 oz.
UPC
044356222778



182UHCP Clam Pack
UPC 044356224345



153UH GOLDEN SPIKE

**7Cr17MoV High Carbon Stainless Steel Blade
Staglon® Handle**

- + Full Tang
- + Nickel Silver Bolsters
- + Sharpening Stone
- + Leather Sheath

Blade Length
5.0" (12.7 cm)
Overall Length
9.4" (23.9 cm)
Weight
6.3 oz.
UPC
044356003063



153UHCP Clam Pack
UPC 044356990592



183UH ELK HUNTER® SKINNER

**7Cr17MoV High Carbon Stainless Steel Blade
Staglon® Handle**

- + Full Tang
- + Brass Guard
- + Leather Belt Sheath

Blade Length
4.6" (11.7 cm)
Overall Length
9.1" (23.1 cm)
Weight
7.8 oz.
UPC
044356222785



183UHCP Clam Pack
UPC 044356224352



171UH PRO HUNTER®

7Cr17MoV High Carbon S.S. Blade Staglon® Handle

- + Brass Bolsters
- + Sharpening Stone
- + Leather Sheath

Blade Length
5.5" (14.0 cm)
Overall Length
9.8" (24.9 cm)
Weight
12.0 oz.
UPC
044356033206



171UHCP Clam Pack
UPC 044356227735



301UH / **DETAIL SKINNER**

7Cr17MoV High Carbon Stainless Steel Blade
Staglon® Handle

- + Full Tang
- + Leather Belt Sheath

Blade Length
3.1" (7.9 cm)
Overall Length
6.5" (16.5 cm)
Weight
2.5 oz.
UPC
044356225731



301UHCP Clam Pack
UPC 044356227629



PH2N / **MINI PRO HUNTER®**

7Cr17MoV High Carbon Stainless Steel Blade
Staglon® Handle

- + Full Tang
- + Nickel Silver Guard
- + Leather Belt Sheath

Blade Length
2.8" (7.1 cm)
Overall Length
6.8" (17.2 cm)
Weight
3.6 oz.
UPC
044356226288



PH2NCP Clam Pack
UPC 044356226646



162UH / **WOLVERINE**

7Cr17MoV High Carbon Stainless Steel Blade
Staglon® Handle

- + Full Tang
- + Nickel Silver Bolster
- + Leather Sheath

Blade Length
3.4" (8.6 cm)
Overall Length
7.4" (18.8 cm)
Weight
3.9 oz.
UPC
044356211239



162UHCP Clam Pack
UPC 044356213967



PH1N / **PRO HUNTER®**

7Cr17MoV High Carbon Stainless Steel Blade
Staglon® Handle

- + Full Tang
- + Nickel Silver Guard
- + Leather Belt Sheath

Blade Length
3.6" (9.1 cm)
Overall Length
8.1" (20.6 cm)
Weight
6.9 oz.
UPC
044356225724



PH1NCP Clam Pack
UPC 044356226639



GRIP A LEGEND



184UH UNCLE HENRY® BOWIE KNIFE

7Cr17MoV High Carbon S.S. Blade Staglon® Handle

- + Full Tang
- + Brass Guard & Pommel
- + Polyester Belt Sheath

Blade Length
9.7" (24.5 cm)
Overall Length
15.1" (38.5 cm)
Weight
1 lb. 5.2 oz.
UPC
044356224888



181UH UNCLE HENRY® BOWIE KNIFE

7Cr17MoV High Carbon S.S. Blade Staglon® Handle

- + Full Tang
- + Nickel Silver Bolster
- + Polyester Sheath

Blade Length
10.0" (25.4 cm)
Overall Length
15.4" (39.0 cm)
Weight
1 lb. 0.2 oz.
UPC
044356222099

181UHCP Clam Pack
UPC 044356222105



184STUH UNCLE HENRY® BOWIE KNIFE

7Cr17MoV High Carbon S.S. Blade Stag Handle

- + Full Tang
- + Brass Guard & Pommel
- + Leather Belt Sheath

Blade Length
9.7" (24.5 cm)
Overall Length
15.1" (38.5 cm)
Weight
1 lb. 3.7 oz.
UPC
044356224895



UHCM2CP OUTDOORSMAN COMBO PACK

7Cr17MoV High Carbon Stainless Steel Blade
Staglon® Handle

- + Full Tang
- + Nickel Silver Guard & Pommel
- + Leather Belt Sheath

301UH Detail Skinner

Blade Length
3.1" (7.9 cm)
Overall Length
6.5" (16.5 cm)
Weight
2.5 oz.

182UH Drop Point

Blade Length
3.8" (9.7 cm)
Overall Length
8.4" (21.4 cm)
Weight
6.3 oz.

Only available in clam pack



UHCM2CP Clam Pack
UPC 044356224482



+ 301UH



+ 182UH



Dual Knife
Leather Belt Sheath

UHCM3CP BOWIE KNIFE COMBO PACK

7Cr17MoV High Carbon Stainless Steel Blade
Staglon® Handle

- + Full Tang
- + Nickel Silver Guard & Pommel
- + Leather Belt Sheath

191UH Bowie

Blade Length
5.1" (13.1 cm)
Overall Length
8.9" (22.5 cm)
Weight
6.1 oz.

191LUH Bowie

Blade Length
8.3" (21.0 cm)
Overall Length
13.0" (32.9 cm)
Weight
1 lb. 0.9 oz.

Only available in clam pack



UHCM3CP Clam Pack
UPC 044356224789

Uncle Henry®
= EVERLASTINGLY SHARP =



+ 191UH



+ 191LUH



Dual Knife
Leather Belt Sheath



167UH LARGE FILLET

7Cr17MoV High Carbon S.S. Blade Staglon® Handle

- + Nickel Silver Bolster
- + Leather Sheath

Blade Length
7.5" (19.1 cm)
Overall Length
12.0" (30.5 cm)
Weight
2.9 oz.
UPC
044356003094



167UHCP-N Clam Pack
UPC 044356215978



168UH SMALL FILLET

7Cr17MoV High Carbon S.S. Blade Staglon® Handle

- + Nickel Silver Bolster
- + Leather Sheath

Blade Length
5.3" (13.4 cm)
Overall Length
10.1" (25.6 cm)
Weight
4.1 oz.
UPC
044356208604



168UHCP Clam Pack
UPC 044356213974



169UH FILLET FOLDER

3Cr14MoV/MH Steel Blade Staglon® Handle

- + Lockback
- + Polyester Sheath

Blade Length
5.5" (14.0 cm)
Overall Length
12.0" (30.5 cm)
Weight
6.0 oz.
UPC
044356216975



OLD TIMER®

== EVERLASTINGLY SHARP ==

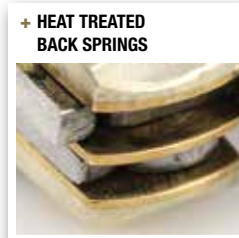
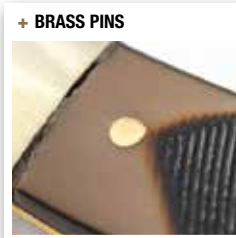

BUILT FOR GENERATIONS

THE TRADITION OF PASSING AN OLD TIMER® KNIFE DOWN FROM ONE GENERATION TO THE NEXT HAS PROVEN OLD TIMER® AS A RELIABLE AND TRUSTED BRAND RECOGNIZED THE WORLD OVER. OLD TIMER® KNIVES SUCH AS OUR TRADITIONAL FOLDERS, FIXED BLADES AND THE COPPERHEAD SERIES ARE DESIGNED TO SERVE YOUR EVERY DAY NEED, YET BUILT FOR GENERATIONS.

- + 7Cr17MoV High Carbon S.S.
- + Drop Point Blade
- + Can Opener
- + Screwdriver & Cap Lifter
- + Awl
- + Shackle
- + Nickel Silver Bolsters



NEW

230T	SCOUT KNIFE		
Blade Length	2.4" (6.2 cm)	Weight	3.5 oz.
Overall Length	6.1" (15.5 cm)	UPC	044356228480

- + 65Mn High Carbon Steel
- + Detail Blade
- + Straight Gouge
- + Hook Blade
- + Straight Gouge
- + V-Scorp
- + Gouge Scorp
- + Chisel
- + Nickel Silver Bolsters



NEW

240T	WOODWORKING KNIFE		
Blade Length	1.5" (3.8 cm)	UPC	044356228473
Overall Length	6.0" (15.3 cm)	240TCP CLAM PACK	
Weight	3.9 oz.	UPC	044356230001

- + 7Cr17MoV High Carbon S.S.
- + Clip Point Blade
- + Sheepsfoot Blade
- + Pen Blade
- + Wharncliffe Blade
- + Nickel Silver Bolsters



440T	WORKMATE		
Blade Length	2.2" (5.6 cm)	Weight	1.8 oz.
Overall Length	5.4" (13.7 cm)	UPC	044356205719

- + 7Cr17MoV High Carbon S.S.
- + Sheepsfoot Blade (2)
- + Pen Blade
- + Coping Blade
- + Nickel Silver Bolsters



40T	BIG MAN		
Blade Length	2.3" (5.8 cm)	Weight	2.6 oz.
Overall Length	5.8" (14.7 cm)	UPC	044356000420

- + 7Cr17MoV High Carbon S.S.
- + Clip Point Blade
- + Sheepsfoot Blade
- + Pen Blade
- + Nickel Silver Bolsters



1080T	JUNIOR		
Blade Length	2.0" (5.1 cm)	UPC	044356001052
Overall Length	4.7" (11.9 cm)	1080TCP CLAM PACK	
Weight	1.2 oz.	UPC	044356001373

- + 7Cr17MoV High Carbon S.S.
- + Clip Point Blade
- + Sheepsfoot Blade
- + Pen Blade
- + Nickel Silver Bolsters

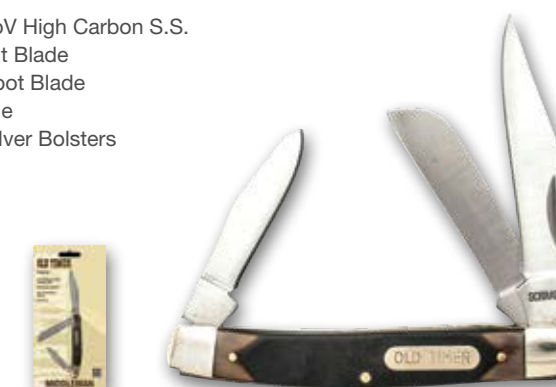

340T	MIDDLEMAN		
Blade Length	2.4" (6.1 cm)	UPC	044356001120
Overall Length	5.7" (14.5 cm)	340TCP CLAM PACK	
Weight	1.8 oz.	UPC	044356001366

- + 7Cr17MoV High Carbon S.S.
- + Spear Point Blade
- + Coping Blade
- + Pen Blade
- + Nickel Silver Bolsters



90T CIGAR WHITTLER

Blade Length 3.0" (7.6 cm) Weight 2.3 oz.
Overall Length 6.9" (17.5 cm) UPC 044356000604

- + 7Cr17MoV High Carbon S.S.
- + Clip Point Blade
- + Pen Blade
- + Scissors
- + Nickel Silver Bolsters



1060T GRANDDAD'S

Blade Length 2.0" (5.1 cm) Weight 1.2 oz.
Overall Length 4.8" (12.2 cm) UPC 044356208345

- + 7Cr17MoV High Carbon S.S.
- + Clip Point Blade
- + Serrated Sheepsfoot Blade
- + Spey Blade
- + Nickel Silver Bolsters



890T BLAZER

Blade Length 3.0" (7.6 cm) Weight 3.0 oz.
Overall Length 7.0" (17.8 cm) UPC 044356208369

- + 7Cr17MoV High Carbon S.S.
- + Clip Point Blade
- + Sheepsfoot Blade
- + Spey Blade
- + Nickel Silver Bolsters



8580T LUMBERJACK

Blade Length 2.8" (7.1 cm) Weight 4.8 oz.
Overall Length 7.4" (18.8 cm) UPC 044356205139

- + 7Cr17MoV High Carbon S.S.
- + Clip Point Blade
- + Sheepsfoot Blade
- + Leather Punch
- + Nickel Silver Bolsters



360T SADDLEMAN

Blade Length 2.4" (6.1 cm) Weight 1.9 oz.
Overall Length 5.7" (14.5 cm) UPC 044356209311

- + 7Cr17MoV High Carbon S.S.
- + Clip Point Blade
- + Sheepsfoot Blade
- + Spey Blade
- + Nickel Silver Bolsters



980T RAMROD

Blade Length 2.7" (6.9 cm) Weight 1.9 oz.
Overall Length 6.3" (16.0 cm) UPC 044356209304

- + 7Cr17MoV Stainless Steel
- + Clip Point Blade
- + Pen Blade
- + Nickel Silver Bolsters



2800T BARLOW

Blade Length 2.3" (5.8 cm) Weight 2.6 oz.
Overall Length 5.7" (14.5 cm) UPC 044356205061

- + 7Cr17MoV Stainless Steel
- + Clip Point Blade
- + Pen Blade
- + Nickel Silver Bolsters



720T DOG LEG JACK

Blade Length 2.3" (5.8 cm) Weight 1.4 oz.
Overall Length 5.2" (13.2 cm) UPC 044356001236

- + 7Cr17MoV High Carbon S.S.
- + Clip Point Blade
- + Sheepsfoot Blade
- + Spey Blade
- + Nickel Silver Bolsters



610T SLIM PREMIUM STOCK

Blade Length 3.0" (7.6 cm) Weight 2.5 oz.
Overall Length 7.0" (17.8 cm) UPC 044356208352

- + 7Cr17MoV High Carbon S.S.
- + Clip Point Blade
- + Sheepsfoot Blade
- + Spey Blade
- + Nickel Silver Bolsters
- + Nylon Sheath



80T SENIOR

Blade Length 3.0" (7.6 cm) Weight 2.8 oz.
Overall Length 6.9" (17.5 cm) UPC 044356001113
80TCP CLAM PACK UPC 044356001380

- + 7Cr17MoV Stainless Steel
- + Clip Point Blade
- + Pen Blade
- + Nickel Silver Bolsters



330T MIDDLEMAN JACK

Blade Length 2.4" (6.1 cm) Weight 1.7 oz.
Overall Length 5.7" (14.5 cm) UPC 044356001083
330TCP CLAM PACK UPC 044356001397

- + 7Cr17MoV Stainless Steel
- + Clip Point Blade
- + Sheepsfoot Blade
- + Nickel Silver Bolsters



930T WRANGLER

Blade Length 2.7" (6.9 cm) Weight 1.9 oz.
Overall Length 6.3" (16.0 cm) UPC 044356208376



- + 7Cr17MoV High Carbon S.S.
- + Clip Point Blade
- + Drop Point Blade
- + Nickel Silver Bolsters



1040T / **MINUTEMAN**

Blade Length 2.0" (5.1 cm) UPC 044356001793
 Overall Length 4.7" (11.9 cm) **1040TCP CLAM PACK**
 Weight 1.0 oz. UPC 044356001663

- + 7Cr17MoV High Carbon S.S.
- + Clip Point Blade (2)
- + Nickel Silver Bolsters



770T / **MUSKRAT**

Blade Length 3.0" (7.6 cm) UPC 044356001106
 Overall Length 6.9" (17.5 cm) **770TCP CLAM PACK**
 Weight 2.8 oz. UPC 044356001441

- + 7Cr17MoV High Carbon S.S.
- + Drop Point Blade
- + Pen Blade
- + Nickel Silver Bolsters



10110T / **SMALL CANOE**

Blade Length 2.2" (5.6 cm) Weight 1.8 oz.
 Overall Length 5.2" (13.2 cm) UPC 044356209151

- + 7Cr17MoV High Carbon S.S.
- + Drop Point Blade
- + Pen Blade
- + Nickel Silver Bolsters



110T / **LARGE CANOE**

Blade Length 2.5" (6.4 cm) Weight 2.5 oz.
 Overall Length 6.1" (15.5 cm) UPC 044356209144

- + 7Cr17MoV High Carbon S.S.
- + Clip Point Blade
- + Hoof Pick
- + Nickel Silver Bolsters



S-0THP / **HOOF PICK**

Blade Length 3.1" (7.9 cm) Weight 3.0 oz.
 Overall Length 7.0" (17.8 cm) UPC 044356001007

- + 7Cr17MoV High Carbon S.S.
- + Clip Point Blade
- + Spey Blade
- + Nickel Silver Bolsters



940T / **GUNSTOCK TRAPPER**

Blade Length 3.0" (7.6 cm) UPC 044356001038
 Overall Length 6.9" (17.5 cm) **940TCP CLAM PACK**
 Weight 2.8 oz. UPC 044356002202

- + 7Cr17MoV High Carbon S.S.
- + Clip Point Blade
- + Spey Blade
- + Nickel Silver Bolsters



950T / **LARGE TRAPPER**

Blade Length 3.3" (8.4 cm) Weight 3.7 oz.
 Overall Length 7.4" (18.8 cm) UPC 044356211284

- + 7Cr17MoV High Carbon S.S.
- + Clip Point Blade w/Thumb Knob
- + Lockblade
- + Pocket Clip
- + Nickel Silver Bolsters



2940T / **LINER LOCK TRAPPER**

Blade Length 3.1" (7.9 cm) Weight 3.4 oz.
 Overall Length 7.2" (18.3 cm) UPC 044356220378

- + 7Cr17MoV High Carbon S.S.
- + Clip Point Blade
- + Spey Blade
- + Nickel Silver Bolsters



2960T / **TRAPPER**

Blade Length 3.2" (8.1 cm) Weight 3.9 oz.
 Overall Length 7.3" (18.5 cm) UPC 044356216104

- + 7Cr17MoV High Carbon S.S.
- + Clip Point Blade
- + Pen Blade
- + Field Pick
- + Tweezers
- + Nickel Silver Bolsters



960T / **BEARHEAD TRAPPER**

Blade Length 3.3" (8.4 cm) Weight 3.7 oz.
 Overall Length 7.4" (18.8 cm) UPC 044356001861

- + 7Cr17MoV High Carbon S.S.
- + Clip Point Blade
- + Gut Hook
- + Saw
- + Nickel Silver Bolsters



690T PREMIUM TRAPPER

Blade Length 3.3" (8.4 cm) UPC 044356208079
 Overall Length 7.4" (18.8 cm) **690TCP CLAM PACK**
 Weight 4.8 oz. UPC 044356209854

- + 7Cr17MoV High Carbon S.S.
- + Clip Point Blade
- + Saw
- + Lockblade
- + Nickel Silver Bolsters
- + Leather Sheath



+ Field Pick & Tweezers

970T BUZZSAW TRAPPER

Blade Length 3.7" (9.4 cm) Weight 4.0 oz.
 Overall Length 7.8" (19.8 cm) UPC 044356002776

- + 7Cr17MoV High Carbon S.S.
- + Clip Point Blade
- + Lanyard Hole
- + Nickel Silver Bolsters



1230T PIONEER

Blade Length 3.1" (7.9 cm) Weight 2.5 oz.
 Overall Length 7.1" (18.0 cm) UPC 044356209380

- + 7Cr17MoV High Carbon S.S.
- + Clip Point Blade w/Thumb Knob
- + Lockblade
- + Pocket Clip
- + Nickel Silver Bolsters



2230T PIONEER

Blade Length 3.1" (7.9 cm) Weight 3.4 oz.
 Overall Length 7.2" (18.3 cm) UPC 044356220385

- + 7Cr17MoV High Carbon S.S.
- + Clip Point Blade
- + Saw
- + Nickel Silver Bolsters
- + Leather Sheath



2250T SON OF A GUN

Blade Length 4.0" (10.1 cm) Weight 5.6 oz.
 Overall Length 9.2" (23.3 cm) UPC 044356209373

- + 7Cr17MoV High Carbon S.S.
- + Clip Point Blade
- + Hatchet
- + Saw
- + Nickel Silver Bolsters
- + Nylon Sheath



2200T FOLDING HUNTER

Blade Length 4.0" (10.2 cm) Weight 8.8 oz.
 Overall Length 9.2" (23.4 cm) UPC 044356204712

- + 7Cr17MoV High Carbon S.S.
- + Drop Point Blade
- + Lockback
- + Nickel Silver Bolsters
- + Leather Sheath



510T BIG TIMER

Blade Length 3.4" (8.6 cm) Weight 6.5 oz.
 Overall Length 8.2" (20.8 cm) UPC 044356208567

- + 7Cr17MoV High Carbon S.S.
- + Clip Point Blade
- + Lockback
- + Nickel Silver Bolsters
- + Leather Sheath

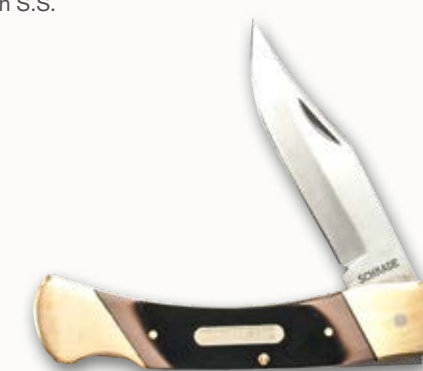

70T CAVE BEAR

Blade Length 3.9" (9.9 cm) Weight 6.8 oz.
 Overall Length 8.7" (22.1 cm) UPC 044356001342

- + 7Cr17MoV High Carbon S.S.
- + Clip Point Blade
- + Sheepfoot Blade
- + Nickel Silver Bolsters
- + Leather Sheath



250T FOLDING HUNTER

Blade Length 4.0" (10.2 cm) Weight 6.7 oz.
 Overall Length 9.3" (23.6 cm) UPC 044356001274

- + 7Cr17MoV High Carbon S.S.
- + Clip Point Blade
- + Nickel Silver Bolsters
- + Leather Sheath

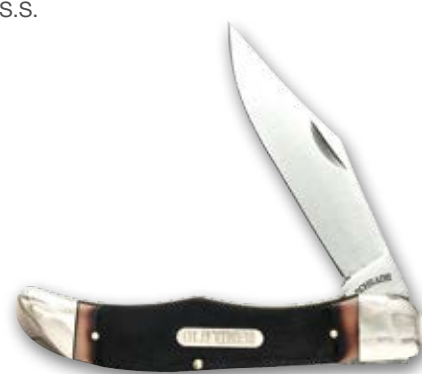

1250T MUSTANG

Blade Length 4.0" (10.2 cm) Weight 4.8 oz.
 Overall Length 9.3" (23.6 cm) UPC 044356002134

- + 7Cr17MoV High Carbon S.S.
- + Clip Point Blade
- + Lockback
- + Brass Bolsters



60T GOLDEN BEAR

Blade Length 3.9" (9.9 cm) Weight 5.9 oz.
 Overall Length 8.7" (22.1 cm) UPC 044356001939

- + 7Cr17MoV High Carbon S.S.
- + Guthook
- + Lockback
- + Nickel Silver Bolsters
- + Nylon Sheath



1570T GOLDEN CLAW

Blade Length 3.5" (8.9 cm) Weight 5.6 oz.
 Overall Length 8.5" (21.6 cm) UPC 044356208383

- + 7Cr17MoV High Carbon S.S.
- + Drop Point Blade
- + Lockback
- + Nickel Silver Bolsters



50T / **BRUIN**

Blade Length 2.8" (7.1 cm) Weight 2.3 oz.
 Overall Length 6.5" (16.5 cm) UPC 044356001243

- + 7Cr17MoV High Carbon S.S.
- + Drop Point Blade
- + Lockback
- + Nickel Silver Bolsters



30T / **BEARHEAD**

Blade Length 2.2" (5.6 cm) UPC 044356001229
 Overall Length 5.1" (13.0 cm) **30TCP CLAM PACK**
 Weight 1.5 oz. UPC 044356205788



- + 7Cr17MoV High Carbon S.S.
- + Sheepsfoot Blade
- + Nickel Silver Bolsters



190T / **LANDSHARK®**

Blade Length 2.6" (6.6 cm) Weight 2.6 oz.
 Overall Length 6.3" (16.0 cm) UPC 044356990974

- + 7Cr17MoV High Carbon S.S.
- + Drop Point Blade
- + Lockback
- + Shackle
- + Nickel Silver Bolsters



10T / **SMALL LOCKBACK**

Blade Length 1.6" (4.0 cm) Weight 0.9 oz.
 Overall Length 3.8" (9.7 cm) UPC 044356205252

- + 7Cr17MoV High Carbon S.S.
- + Clip Point Blade
- + Nickel Silver Bolsters



120T / **PAL**

Blade Length 2.2" (5.6 cm) UPC 044356001786
 Overall Length 5.1" (13.0 cm) **120TCP CLAM PACK**
 Weight 1.1 oz. UPC 044356001656

- + 7Cr17MoV High Carbon S.S.
- + Hawkbill Blade
- + Nickel Silver Bolsters



160T / **HAWKBILL PRUNER**

Blade Length 3.0" (7.6 cm) Weight 3.4 oz.
 Overall Length 7.0" (17.8 cm) UPC 044356210249

- + 7Cr17MoV High Carbon S.S.
- + Hawkbill Blade w/Thumb Knob
- + Lockblade
- + Pocket Clip
- + Nickel Silver Bolsters



2160T / **HAWKBILL PRUNER**

Blade Length 3.0" (7.6 cm) Weight 4.1 oz.
 Overall Length 7.0" (17.8 cm) UPC 044356221900

- + 7Cr17MoV High Carbon S.S.
- + Clip Point Blade
- + Lockblade
- + Nickel Silver Bolsters



180T / **MIGHTY MITE**

Blade Length 2.0" (5.1 cm) UPC 044356001045
 Overall Length 4.7" (11.9 cm) **180TCP CLAM PACK**
 Weight 1.0 oz. UPC 044356001403

- + 7Cr17MoV High Carbon S.S.
- + Clip Point Blade
- + Lockblade
- + Nickel Silver Bolsters



1940T / **GUNSTOCK TRAPPER**

Blade Length 3.1" (7.9 cm) UPC 044356001069
 Overall Length 7.0" (17.8 cm) **1940TCP CLAM PACK**
 Weight 2.4 oz. UPC 044356207812

- + 7Cr17MoV High Carbon S.S.
- + Hawkbill Blade
- + Nickel Silver Bolsters



1590T / **ELECTRICIAN'S KNIFE**

Blade Length 2.7" (6.9 cm) Weight 3.3 oz.
 Overall Length 6.4" (16.1 cm) UPC 044356900232

- + 7Cr17MoV High Carbon S.S.
- + Clip Point Blade
- + Marlin Spike
- + Leverlock
- + Nickel Silver Bolsters



7350T / **MARINER**

Blade Length 2.8" (7.1 cm) Weight 4.4 oz.
 Overall Length 6.9" (17.5 cm) UPC 044356217583

140T HUNTER

7Cr17MoV High Carbon Stainless Steel Blade

- + Nickel Silver Bolster
- + Full Tang
- + OT Saw Cut Handle
- + Leather Sheath

Blade Length
3.7" (9.4 cm)
Overall Length
8.4" (21.3 cm)
Weight
7.6 oz.
UPC
044356209328



1560T LIL' FINGER

7Cr17MoV High Carbon Stainless Steel Blade

- + Nickel Silver Bolster
- + Full Tang
- + OT Saw Cut Handle
- + Leather Sheath

Blade Length
2.5" (6.3 cm)
Overall Length
6.6" (16.7 cm)
Weight
3.9 oz.
UPC
044356206693



1620T BOOT KNIFE

7Cr17MoV High Carbon Stainless Steel Blade

- + Nickel Silver Bolster
- + Full Tang
- + OT Saw Cut Handle
- + Leather Sheath

Blade Length
3.8" (9.6 cm)
Overall Length
7.8" (19.8 cm)
Weight
3.9 oz.
UPC
044356204705
No Ship CA, NY, MA



150T DEERSLAYER

7Cr17MoV High Carbon Stainless Steel Blade

- + Full Tang
- + OT Saw Cut Handle
- + Leather Sheath

Blade Length
5.6" (14.2 cm)
Overall Length
10.5" (26.7 cm)
Weight
7.7 oz.
UPC
044356001175



150TCP Clam Pack
UPC 044356000307



1580T GUTHOOK SKINNER

7Cr17MoV High Carbon Stainless Steel Blade

- + Full Tang
- + OT Saw Cut Handle
- + Leather Sheath

Blade Length
3.5" (8.9 cm)
Overall Length
7.3" (18.5 cm)
Weight
3.3 oz.
UPC
044356001250



1580TCP Clam Pack
UPC 044356001519



1520TBC / **PRO HUNTER® SHARPFINGER®**

7Cr17MoV High Carbon Stainless Steel Blade

- + Full Tang
- + Pro Hunter® Camo Handle
- + Leather Sheath

Blade Length
3.3" (8.4 cm)
Overall Length
7.1" (18.0 cm)
Weight
3.1 oz.
UPC
044356001021



1520T / **SHARPFINGER®**

7Cr17MoV High Carbon Stainless Steel Blade

- + Full Tang
- + OT Saw Cut Handle
- + Leather Sheath

Blade Length
3.3" (8.4 cm)
Overall Length
7.1" (18.0 cm)
Weight
3.1 oz.
UPC
044356001168



1520TCP Clam Pack
UPC 044356001427

1520TL / **LARGE SHARPFINGER®**

7Cr17MoV High Carbon Stainless Steel Blade

- + Full Tang
- + OT Saw Cut Handle
- + Leather Sheath

Blade Length
4.0" (10.1 cm)
Overall Length
8.6" (21.8 cm)
Weight
6.0 oz.
UPC
044356226264



1520TLCP Clam Pack
UPC 044356226271

1600T / **MOUNTAIN LION**

7Cr17MoV High Carbon Stainless Steel Blade

- + Full Tang
- + OT Saw Cut Handle
- + Nickel Silver Bolster
- + Leather Sheath

Blade Length
5.0" (12.7 cm)
Overall Length
9.3" (23.6 cm)
Weight
6.9 oz.
UPC
044356001281



1650T / **WOODSMAN**

7Cr17MoV High Carbon Stainless Steel Blade

- + Full Tang
- + OT Saw Cut Handle
- + Nickel Silver Bolster
- + Leather Sheath

Blade Length
5.0" (12.7 cm)
Overall Length
9.3" (23.6 cm)
Weight
8.3 oz.
UPC
044356000314



1650TCP Clam Pack
UPC 044356000321

- + Mirror Polished 9Cr18MoV High Carbon Stainless Steel
- + Clip Point Blade
- + Sheepsfoot Blade
- + Pen Blade
- + Saw Cut Bone Handle
- + Nickel Silver Bolsters



GENUINE BONE

340TB MIDDLEMAN

Blade Length 2.4" (6.1 cm) UPC 044356222297
 Overall Length 5.6" (14.3 cm) **340TB** CLAM PACK
 Weight 1.8 oz. UPC 044356223997

- + Mirror Polished 9Cr18MoV High Carbon Stainless Steel
- + Clip Point Blade
- + Sheepsfoot Blade
- + Spey Blade
- + Saw Cut Bone Handle
- + Nickel Silver Bolsters



GENUINE BONE

8580TB LUMBERJACK STOCKMAN

Blade Length 3.4" (8.7 cm) UPC 044356222280
 Overall Length 7.9" (20.2 cm) **8580TB** CLAM PACK
 Weight 4.6 oz. UPC 044356222969

- + 7Cr17MoV High Carbon S.S.
- + Clip Point Blade
- + Pen Blade
- + Old Timer Yellow Handle
- + Nickel Silver Bolsters



330TY MIDDLEMAN JACK

Blade Length 2.4" (6.1 cm) UPC 044356000543
 Overall Length 5.7" (14.5 cm) **330TY** CLAM PACK
 Weight 1.7 oz. UPC 044356210829

- + 7Cr17MoV High Carbon S.S.
- + Clip Point Blade
- + Sheepsfoot Blade
- + Pen Blade
- + Old Timer Yellow Handle
- + Nickel Silver Bolsters



340TY MIDDLEMAN

Blade Length 2.4" (6.1 cm) UPC 044356000550
 Overall Length 5.7" (14.5 cm) **340TY** CLAM PACK
 Weight 1.5 oz. UPC 044356203890

- + Mirror Polished 9Cr18MoV High Carbon Stainless Steel
- + Clip Point Blade
- + Spey Blade
- + Saw Cut Bone Handle
- + Nickel Silver Bolsters



GENUINE BONE

940TB GUNSTOCK TRAPPER

Blade Length 3.0" (7.7 cm) UPC 044356222273
 Overall Length 6.8" (17.4 cm) **940TB** CLAM PACK
 Weight 2.8 oz. UPC 044356223980

- + Mirror Polished 9Cr18MoV High Carbon Stainless Steel
- + Clip Point Blade
- + Spey Blade
- + Saw Cut Bone Handle
- + Nickel Silver Bolsters



GENUINE BONE

950TB LARGE TRAPPER

Blade Length 3.1" (8.0 cm) UPC 044356222303
 Overall Length 7.3" (18.6 cm) **950TB** CLAM PACK
 Weight 3.5 oz. UPC 044356222976

- + 7Cr17MoV High Carbon S.S.
- + Clip Point Blade
- + Sheepsfoot Blade
- + Pen Blade
- + Wharnccliffe Blade
- + Old Timer Yellow Handle
- + Nickel Silver Bolsters



440TY WORKMATE

Blade Length 2.2" (5.6 cm) UPC 044356214711
 Overall Length 5.4" (13.7 cm) **440TY** CLAM PACK
 Weight 1.8 oz. UPC 044356214582

- + 7Cr17MoV High Carbon S.S.
- + Clip Point Blade
- + Sheepsfoot Blade
- + Spey Blade
- + Old Timer Yellow Handle
- + Nickel Silver Bolsters



80TY SENIOR

Blade Length 3.0" (7.6 cm) UPC 044356001328
 Overall Length 6.9" (17.5 cm) **80TY** CLAM PACK
 Weight 2.8 oz. UPC 044356202862

- + Mirror Polished 9Cr18MoV High Carbon Stainless Steel
- + Clip Point Blade
- + Sheepsfoot Blade
- + Spey Blade
- + Saw Cut Bone Handle
- + Nickel Silver Bolsters



GENUINE BONE

80TB SENIOR

Blade Length 3.0" (7.5 cm) UPC 044356222853
 Overall Length 6.9" (17.5 cm) **80TB** CLAM PACK
 Weight 3.0 oz. UPC 044356222952

- + Mirror Polished 9Cr18MoV High Carbon Stainless Steel
- + Clip Point Blade
- + Pen Blade
- + Saw Cut Bone Handle
- + Nickel Silver Bolsters



GENUINE BONE

720TB DOG LEG JACK

Blade Length 2.3" (5.7 cm) UPC 044356222945
 Overall Length 5.1" (13.0 cm) **720TB** CLAM PACK
 Weight 1.6 oz. UPC 044356222983

- + 7Cr17MoV High Carbon S.S.
- + Clip Point Blade (2)
- + Old Timer Yellow Handle
- + Nickel Silver Bolsters



770TY MUSKRAT

Blade Length 3.0" (7.6 cm) Weight 2.6 oz.
 Overall Length 6.9" (17.5 cm) UPC 044356203500

- + 7Cr17MoV High Carbon S.S.
- + Clip Point Blade
- + Spey Blade
- + Old Timer Yellow Handle
- + Nickel Silver Bolsters



940TY GUNSTOCK TRAPPER

Blade Length 3.0" (7.6 cm) UPC 044356000536
 Overall Length 6.9" (17.5 cm) **940TY** CLAM PACK
 Weight 2.5 oz. UPC 044356210850

- + 7Cr17MoV High Carbon S.S.
- + Clip Point Blade
- + Pen Blade
- + Desert Iron Wood Handle
- + Nickel Silver Bolsters



330TW MIDDLEMAN JACK

Blade Length 2.4" (6.1 cm) Weight 1.7 oz.
Overall Length 5.7" (14.5 cm) UPC 044356203487

- + 7Cr17MoV High Carbon S.S.
- + Clip Point Blade
- + Sheepfoot Blade
- + Pen Blade
- + Desert Iron Wood Handle
- + Nickel Silver Bolsters



1080TW JUNIOR

Blade Length 2.0" (5.1 cm) Weight 1.2 oz.
Overall Length 4.7" (11.9 cm) UPC 044356000239

- + 7Cr17MoV High Carbon S.S.
- + Clip Point Blade
- + Sheepfoot Blade
- + Pen Blade
- + Desert Iron Wood Handle
- + Nickel Silver Bolsters



340TW MIDDLEMAN

Blade Length 2.4" (6.1 cm) Weight 1.8 oz.
Overall Length 5.7" (14.5 cm) UPC 044356000192

- + 7Cr17MoV High Carbon S.S.
- + Clip Point Blade
- + Sheepfoot Blade
- + Spey Blade
- + Desert Iron Wood Handle
- + Nickel Silver Bolsters



80TW SENIOR

Blade Length 3.0" (7.6 cm) Weight 2.6 oz.
Overall Length 6.9" (17.5 cm) UPC 044356000208

- + 7Cr17MoV High Carbon S.S.
- + Clip Point Blade (2)
- + Desert Iron Wood Handle
- + Nickel Silver Bolsters



770TW MUSKRAT

Blade Length 3.0" (7.6 cm) Weight 2.6 oz.
Overall Length 6.9" (17.5 cm) UPC 044356000215

- + 7Cr17MoV High Carbon S.S.
- + Clip Point Blade
- + Spey Blade
- + Desert Iron Wood Handle
- + Nickel Silver Bolsters



940TW GUNSTOCK TRAPPER

Blade Length 3.0" (7.6 cm) Weight 2.5 oz.
Overall Length 6.9" (17.5 cm) UPC 044356000222

60TW GOLDEN BEAR®

**7Cr17MoV High Carbon Stainless Steel Blade
Desert Iron Wood Handle**

- + Brass Guard
- + Lockback
- + Leather Sheath

Blade Length 3.9" (9.9 cm)
Overall Length 8.7" (22.1 cm)
Weight 5.9 oz.

UPC 044356000246



60TWCP Clam Pack
UPC 044356200301

PH2W MINI PRO HUNTER®

**7Cr17MoV High Carbon Stainless Steel Blade
Desert Iron Wood Handle**

- + Full Tang
- + Nickel Silver Guard
- + Leather Sheath

Blade Length 2.8" (7.1 cm)
Overall Length 6.9" (17.5 cm)
Weight 3.5 oz.

UPC 044356001557



PHW PRO HUNTER®

**7Cr17MoV High Carbon Stainless Steel Blade
Desert Iron Wood Handle**

- + Full Tang
- + Nickel Silver Guard
- + Leather Sheath

Blade Length 3.6" (9.1 cm)
Overall Length 8.0" (20.3 cm)
Weight 6.2 oz.

UPC 044356000659



280T MOUNTAIN BEAVER JR.

**9Cr18MoV High Carbon Stainless Steel Blade
Rosewood/Ebony Handle**

- + Nickel Silver Bolster
- + Lockback
- + Leather Sheath

Blade Length
2.5" (6.4 cm)
Overall Length
6.1" (15.5 cm)
Weight
2.8 oz.
UPC
044356218887



280TCP Clam Pack
UPC 044356219778



290T MOUNTAIN BEAVER SR.

**9Cr18MoV High Carbon Stainless Steel Blade
Rosewood/Ebony Handle**

- + Nickel Silver Bolster
- + Lockback
- + Leather Sheath

Blade Length
3.2" (8.1 cm)
Overall Length
7.7" (19.6 cm)
Weight
5.1 oz.
UPC
044356218894



290TCP Clam Pack
UPC 044356219785



300T CAPYBARA®

**8Cr13MoV High Carbon Stainless Steel Blade
Rosewood/Ebony Handle**

- + Brass Guard
- + Full Tang
- + Leather Sheath

Blade Length
4.0" (10.2 cm)
Overall Length
8.5" (21.5 cm)
Weight
6.3 oz.
UPC
044356224918



300TCP Clam Pack
UPC 044356225717



OLD TIMER®

== EVERLASTINGLY SHARP ==

310T LOCKBACK FOLDING KNIFE

NEW

**7Cr17MoV High Carbon Stainless Steel Blade
Wood Handle**

- + Dual Thumb Knobs
- + Nickel Silver Bolster
- + Lockback
- + Pocket Clip

Blade Length
2.9" (7.3 cm)
Overall Length
6.5" (16.5 cm)
Weight
3.2 oz.
UPC
044356229852



310TCP Clam Pack
UPC 044356229869



320T LOCKBACK FOLDING KNIFE

NEW

**7Cr17MoV High Carbon Stainless Steel Blade
Wood Handle**

- + Dual Thumb Knobs
- + Nickel Silver Bolster
- + Lockback
- + Pocket Clip

Blade Length
3.4" (8.6 cm)
Overall Length
7.7" (19.4 cm)
Weight
5.0 oz.
UPC
044356229876



320TCP Clam Pack
UPC 044356229883





COPPERHEAD

21560TKCP FIXED CAPING KNIFE

NEW

Ti-Nitride Coated 7Cr17MoV High Carbon S.S. Blade
Oak Handle

- + Full Tang
- + Polyester Belt Sheath

Blade Length
2.3" (5.8 cm)
Overall Length
6.8" (17.4 cm)
Weight
2.5 oz.
UPC
044356227964

Only available in clam pack



21560TRWCP FIXED CAPING KNIFE

NEW

Black Coated 7Cr17MoV High Carbon S.S. Blade
Rosewood Handle

- + Full Tang
- + Polyester Belt Sheath

Blade Length
2.3" (5.8 cm)
Overall Length
6.8" (17.4 cm)
Weight
2.5 oz.
UPC
044356227902

Only available in clam pack



21560TWNCP FIXED CAPING KNIFE

NEW

Mirror Polished 7Cr17MoV High Carbon S.S. Blade
Walnut Handle

- + Full Tang
- + Polyester Belt Sheath

Blade Length
2.3" (5.8 cm)
Overall Length
6.8" (17.4 cm)
Weight
2.4 oz.
UPC
044356227933

Only available in clam pack



21410TOKCP **FIXED DROP POINT**

NEW



Ti-Nitride Coated 7Cr17MoV High Carbon S.S. Blade
Oak Handle

- + Full Tang
- + Polyester Belt Sheath

Blade Length
3.7" (9.4 cm)
Overall Length
8.1" (20.5 cm)
Weight
6.1 oz.
UPC
044356227940



Only available in clam pack

21430TOKCP **FIXED GUT HOOK**

NEW



Ti-Nitride Coated 7Cr17MoV High Carbon S.S. Blade
Oak Handle

- + Full Tang
- + Polyester Belt Sheath

Blade Length
3.7" (9.4 cm)
Overall Length
8.1" (20.5 cm)
Weight
6.2 oz.
UPC
044356227957



Only available in clam pack

21410TRWCP **FIXED DROP POINT**

NEW



Black Coated 7Cr17MoV High Carbon S.S. Blade
Rosewood Handle

- + Full Tang
- + Polyester Belt Sheath

Blade Length
3.7" (9.4 cm)
Overall Length
8.1" (20.5 cm)
Weight
6.2 oz.
UPC
044356227889



Only available in clam pack

21430TRWCP **FIXED GUT HOOK**

NEW



Black Coated 7Cr17MoV High Carbon S.S. Blade
Rosewood Handle

- + Full Tang
- + Polyester Belt Sheath

Blade Length
3.7" (9.4 cm)
Overall Length
8.1" (20.5 cm)
Weight
6.3 oz.
UPC
044356227896



Only available in clam pack

21410TWNCP **FIXED DROP POINT**

NEW



Mirror Polished 7Cr17MoV High Carbon S.S. Blade
Walnut Handle

- + Full Tang
- + Polyester Belt Sheath

Blade Length
3.7" (9.4 cm)
Overall Length
8.1" (20.5 cm)
Weight
6.1 oz.
UPC
044356227919



Only available in clam pack

21430TWNCP **FIXED GUT HOOK**

NEW



Mirror Polished 7Cr17MoV High Carbon S.S. Blade
Walnut Handle

- + Full Tang
- + Polyester Belt Sheath

Blade Length
3.7" (9.4 cm)
Overall Length
8.1" (20.5 cm)
Weight
6.1 oz.
UPC
044356227926



Only available in clam pack

21500T FOLDING SAW

3Cr13MoV High Carbon S.S. Blade
Rubber Handle

- + Liner Lock
- + Polyester Belt Sheath

Blade Length
6.6" (16.7 cm)
Overall Length
14.9" (37.9 cm)
Weight
13.2 oz.
UPC
044356226257



21500TCP Clam Pack
UPC 044356226653

21400T WOOD & BONE SAW

3Cr13MoV High Carbon S.S. Blade
TPE Handle

- + Folding T Handle
- + Polyester Sheath

Blade Length
9.1" (23.0 cm)
Overall Length
12.2" (31.1 cm)
Weight
7.1 oz.
UPC
044356223126

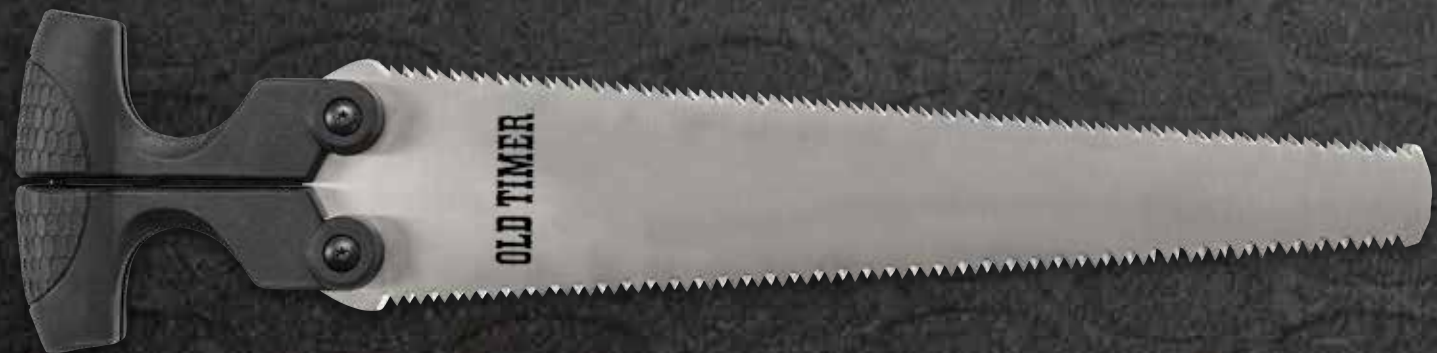

21400TCP Clam Pack
UPC 044356223133

21440T DOUBLE RATTLER SAFE-T-LOCK®

Ti-Nitride Coated 7Cr17MoV High Carbon S.S. Blade
Rubber Overmold Handle

- + Drop Point Blade & Saw Blade
- + Double Lockback
- + Molded Polyester Belt Sheath

Blade Length
3.5" (8.8 cm)
Overall Length
8.1" (20.6 cm)
Weight
8.1 oz.
UPC
044356223065



21440TCP Clam Pack
UPC 044356223072

21560T FIXED CAPING KNIFE

Ti-Nitride Coated 7Cr17MoV High Carbon S.S. Blade
ABS Handle

- + Full Tang
- + Polyester Belt Sheath

Blade Length
2.3" (5.8 cm)
Overall Length
6.8" (17.4 cm)
Weight
3.0 oz.
UPC
044356226202



21560TCP Clam Pack
UPC 044356226660

21410T **FIXED DROP POINT**

Ti-Nitride Coated 7Cr17MoV High Carbon S.S. Blade
Rubber Overmold Handle

- + Full Tang
- + Polyester Belt Sheath

Blade Length
3.7" (9.4 cm)
Overall Length
8.1" (20.5 cm)
Weight
6.5 oz.
UPC
044356223003



21410TCP Clam Pack
UPC 044356223010

21430T **FIXED GUT HOOK**

Ti-Nitride Coated 7Cr17MoV High Carbon S.S. Blade
Rubber Overmold Handle

- + Full Tang
- + Polyester Belt Sheath

Blade Length
3.7" (9.4 cm)
Overall Length
8.1" (20.5 cm)
Weight
6.5 oz.
UPC
044356223027



21430TCP Clam Pack
UPC 044356223034

21450T **SWING GUT SAFE-T-LOCK®**

Ti-Nitride Coated 7Cr17MoV High Carbon S.S. Blade
Rubber Overmold Handle

- + Drop Point Blade w/Folding Guard To Create Gut Hook Blade
- + Thumb Knob
- + Lockback Folding Knife
- + Molded Polyester Belt Sheath

Blade Length
3.4" (8.6 cm)
Overall Length
7.7" (19.6 cm)
Weight
4.2 oz.
UPC
044356223089



21450TCP Clam Pack
UPC 044356223096



21470T **FOLDING DROP POINT**

Ti-Nitride Coated 7Cr17MoV High Carbon S.S. Blade
Rubber Overmold Handle

- + Dual Thumb Knobs
- + Liner Lock
- + Molded Polyester Belt Sheath

Blade Length
3.4" (8.6 cm)
Overall Length
7.8" (19.8 cm)
Weight
4.6 oz.
UPC
044356223508



21470TCP Clam Pack
UPC 044356223515



21480T **FOLDING GUT HOOK**

Ti-Nitride Coated 7Cr17MoV High Carbon S.S. Blade
Rubber Overmold Handle

- + Dual Thumb Knobs
- + Liner Lock
- + Molded Polyester Belt Sheath

Blade Length
3.4" (8.6 cm)
Overall Length
7.8" (19.8 cm)
Weight
4.6 oz.
UPC
044356223522



21480TCP Clam Pack
UPC 044356223539





31500TCP T-HANDLE SAW

NEW

3Cr13MoV S.S. Blade
OT Saw Cut Handle

- + OT Saw Cut Handle
- + Sheath

Blade Length
6.1" (15.4 cm)

Overall Length
8.2" (20.9 cm)

Weight
2.6 oz.

UPC
044356228596

Only available in clam pack



6020TCP TAKE-A-PART 8" SHEARS

NEW

2Cr13MoV Stainless Steel Blades
Soft Rubber & Hard Nylon Handles

- + Nylon Belt Sheath

Blade Length
4.0" (10.2 cm)

Overall Length
8.2" (20.9 cm)

Weight
3.4 oz.

UPC
044356228015

Only available in clam pack



Comes Apart For Easy Cleaning

IMPERIAL

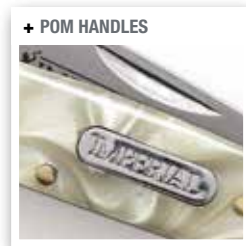
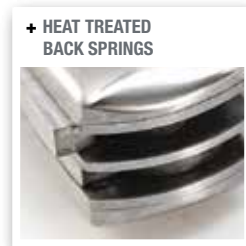
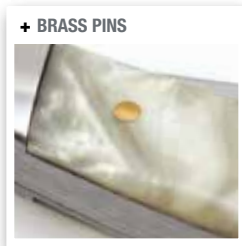

THE EDGE YOU NEED

FORGED WITH AN EYE FOR QUALITY AND STYLE, OUR IMPERIAL LINE OF KNIVES REFLECT THE SKILLFUL LABOR OF KNIFE MAKERS STRETCHING BACK GENERATIONS. DESIGNED TO GIVE EVERY CRAFTSMAN AND TRADESMAN THE EDGE HE NEEDS, IMPERIAL BLADES SUCH AS OUR RAZOR SHARP FRUIT SAMPLER KNIVES AND TRADITIONAL-PATTERNED FOLDING POCKET KNIVES ENSURE THAT ANY CUTTING TASK BECOMES QUICK WORK.



IMPCOM1CP
IMP41 & IMP43 COMBO
 UPC
 044356229388



IMPCOM3CP
IMP42 & IMP45 COMBO
 UPC
 044356229401



IMPCOM4CP
IMP40, IMP44 & IMP45 COMBO
 UPC
 044356229418



- + 3Cr13MoV High Carbon S.S.
- + Clip Point Blade
- + Shackle



IMP40 LOCKBACK
 Blade Length 1.6" (4.1 cm)
 Overall Length 3.8" (9.7 cm)
 Weight 0.8 oz.
 UPC 044356228749

- + 3Cr13MoV High Carbon S.S.
- + Clip Point Blade



IMP41 LOCKBACK
 Blade Length 2.2" (5.6 cm)
 Overall Length 5.1" (13.0 cm)
 Weight 1.4 oz.
 UPC 044356228756

- + 3Cr13MoV High Carbon S.S.
- + Clip Point Blade
- + Pen Blade



IMP42 DOG LEG JACK
 Blade Length 2.1" (5.3 cm)
 Overall Length 5.0" (12.7 cm)
 Weight 1.2 oz.
 UPC 044356228763

- + 3Cr13MoV High Carbon S.S.
- + Clip Point Blade
- + Pen Blade
- + Scissors



IMP43 FOLDER
 Blade Length 2.1" (5.3 cm)
 Overall Length 4.8" (12.2 cm)
 Weight 1.2 oz.
 UPC 044356228770

- + 3Cr13MoV High Carbon S.S.
- + Clip Point Blade
- + Pen Blade
- + Shackle



IMP44 FOLDER
 Blade Length 2.0" (5.1 cm)
 Overall Length 4.8" (12.2 cm)
 Weight 1.0 oz.
 UPC 044356228787

- + 3Cr13MoV High Carbon S.S.
- + Clip Point Blade
- + Sheepfoot Blade
- + Pen Blade



IMP45 STOCKMAN
 Blade Length 2.4" (6.2 cm)
 Overall Length 5.7" (14.4 cm)
 Weight 1.7 oz.
 UPC 044356229081

- + 3Cr13MoV Stainless Steel
- + Drop Point Blade
- + Pen Blade
- + Stainless Steel Bolsters



IMP1011 **SMALL CANOE**

Blade Length 2.2" (5.6 cm) Weight 1.8 oz.
Overall Length 5.2" (13.2 cm) UPC 044356215459

- + 3Cr13MoV Stainless Steel
- + Drop Point Blade
- + Pen Blade
- + Stainless Steel Bolsters



IMP11 **LARGE CANOE**

Blade Length 2.5" (6.4 cm) Weight 2.5 oz.
Overall Length 6.1" (15.5 cm) UPC 044356215442

- + 3Cr13MoV Stainless Steel
- + Spear Point Blade
- + Coping Blade
- + Pen Blade
- + Stainless Steel Bolsters



IMP9 **CIGAR WHITTILER**

Blade Length 3.0" (7.6 cm) Weight 2.3 oz.
Overall Length 6.9" (17.5 cm) UPC 044356215466

- + 3Cr13MoV Stainless Steel
- + Sheepsfoot Blade (2)
- + Coping Blade
- + Pen Blade
- + Stainless Steel Bolsters



IMP20CI **CONGRESS**

Blade Length 2.2" (5.6 cm) Weight 2.3 oz.
Overall Length 5.8" (14.7 cm) UPC 044356205696

- + 3Cr13MoV Stainless Steel
- + Clip Point Blade
- + Spey Blade
- + Stainless Steel Bolsters



IMP13 **TRAPPER**

Blade Length 2.2" (5.6 cm) Weight 1.4 oz.
Overall Length 5.0" (12.7 cm) UPC 044356204767

- + 3Cr13MoV Stainless Steel
- + Clip Point Blade
- + Spey Blade
- + Stainless Steel Bolsters

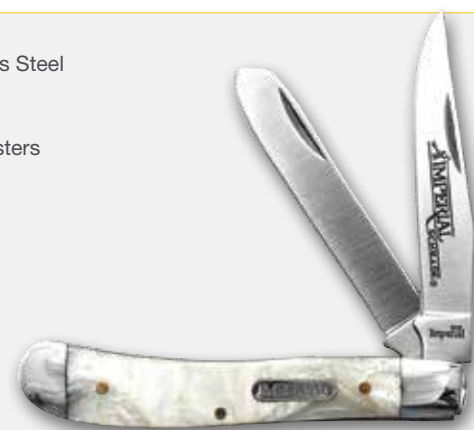

IMP13L **LARGE TRAPPER**

Blade Length 3.0" (7.6 cm) Weight 3.0 oz.
Overall Length 7.0" (17.8 cm) UPC 044356204774

IMPERIAL



- + 3Cr13MoV Stainless Steel
- + Clip Point Blade
- + Small Clip Point Blade
- + Pen Blade
- + Stainless Steel Bolsters

IMP24 **WHITTILER**

Blade Length 2.3" (5.9 cm) Weight 2.5 oz.
Overall Length 5.8" (14.8 cm) UPC 044356222723

- + 3Cr13MoV Stainless Steel
- + Drop Point Blade
- + Lockback
- + Stainless Steel Bolsters



IMP23 **LOCKBACK**

Blade Length 2.6" (6.5 cm) Weight 2.8 oz.
Overall Length 6.3" (15.9 cm) UPC 044356222716

- + 3Cr13MoV Stainless Steel
- + Clip Point Blade
- + Sheepsfoot Blade
- + Spey Blade
- + Stainless Steel Bolsters



IMP14 **STOCKMAN**

Blade Length 1.8" (4.6 cm) Weight 1.1 oz.
Overall Length 4.5" (11.4 cm) UPC 044356204781

- + 3Cr13MoV Stainless Steel
- + Clip Point Blade
- + Sheepsfoot Blade
- + Spey Blade
- + Stainless Steel Bolsters

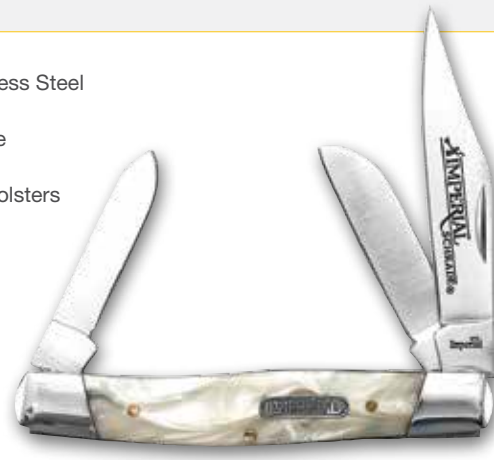

IMP14L **LARGE STOCKMAN**

Blade Length 3.0" (7.6 cm) Weight 2.8 oz.
Overall Length 6.9" (17.5 cm) UPC 044356204798

- + 3Cr13MoV Stainless Steel
- + Clip Point Blade
- + Sheepsfoot Blade
- + Spey Blade
- + Stainless Steel Bolsters



IMP25 **SOWBELLY**

Blade Length 2.7" (6.7 cm) Weight 3.0 oz.
Overall Length 6.4" (16.2 cm) UPC 044356222730

- + 3Cr13MoV Stainless Steel
- + Clip Point Blade
- + Spey Blade
- + Stainless Steel Bolsters



IMPI5T / **TRAPPER**

Blade Length 2.7" (6.8 cm) Weight 2.5 oz.
Overall Length 6.2" (15.7 cm) UPC 044356205504

- + 3Cr13MoV Stainless Steel
- + Clip Point Blade
- + Spey Blade
- + Stainless Steel Bolsters



IMPI6T / **TRAPPER**

Blade Length 2.7" (6.8 cm) Weight 2.5 oz.
Overall Length 6.2" (15.7 cm) UPC 044356205528

- + 3Cr13MoV Stainless Steel
- + Clip Point Blade
- + Spey Blade
- + Stainless Steel Bolsters



IMPI7T / **TRAPPER**

Blade Length 2.7" (6.8 cm) Weight 2.5 oz.
Overall Length 6.2" (15.7 cm) UPC 044356205542

- + 3Cr13MoV Stainless Steel
- + Clip Point Blade
- + Spey Blade
- + Stainless Steel Bolsters



IMI9PRT / **TRAPPER**

Blade Length 2.2" (5.6 cm) Weight 1.4 oz.
Overall Length 5.0" (12.7 cm) UPC 044356205580

- + 3Cr13MoV Stainless Steel
- + Clip Point Blade
- + Sheepsfoot Blade
- + Spey Blade
- + Stainless Steel Bolsters



IMPI5S / **STOCKMAN**

Blade Length 2.5" (6.4 cm) Weight 1.9 oz.
Overall Length 5.9" (15.0 cm) UPC 044356205511

- + 3Cr13MoV Stainless Steel
- + Clip Point Blade
- + Sheepsfoot Blade
- + Spey Blade
- + Stainless Steel Bolsters



IMPI6S / **STOCKMAN**

Blade Length 2.5" (6.4 cm) Weight 1.9 oz.
Overall Length 5.9" (15.0 cm) UPC 044356205535

- + 3Cr13MoV Stainless Steel
- + Clip Point Blade
- + Sheepsfoot Blade
- + Spey Blade
- + Stainless Steel Bolsters



IMPI7S / **STOCKMAN**

Blade Length 2.5" (6.4 cm) Weight 1.9 oz.
Overall Length 5.9" (15.0 cm) UPC 044356205559

- + 3Cr13MoV Stainless Steel
- + Clip Point Blade
- + Sheepsfoot Blade
- + Spey Blade
- + Stainless Steel Bolsters



IMPI9PRS / **STOCKMAN**

Blade Length 1.8" (4.6 cm) Weight 1.1 oz.
Overall Length 4.5" (11.4 cm) UPC 044356205597

- + 3Cr13MoV Stainless Steel
- + Sheepsfoot Blade (2)
- + Coping Blade
- + Pen Blade
- + Stainless Steel Bolsters



IMPI5CON / **CONGRESS**

Blade Length 2.1" (5.3 cm) Weight 2.5 oz.
Overall Length 5.7" (14.5 cm) UPC 044356206549

- + 3Cr13MoV Stainless Steel
- + Sheepsfoot Blade (2)
- + Coping Blade
- + Pen Blade
- + Stainless Steel Bolsters



IMPI6CON / **CONGRESS**

Blade Length 2.1" (5.3 cm) Weight 2.5 oz.
Overall Length 5.7" (14.5 cm) UPC 044356206556

- + 3Cr13MoV Stainless Steel
- + Sheepsfoot Blade (2)
- + Coping Blade
- + Pen Blade
- + Stainless Steel Bolsters



IMPI7CON / **CONGRESS**

Blade Length 2.1" (5.3 cm) Weight 2.5 oz.
Overall Length 5.7" (14.5 cm) UPC 044356206532

- + 3Cr13MoV Stainless Steel
- + Clip Point Blade
- + Stainless Steel Bolsters



IMP21CI / **PEANUT**

Blade Length 1.9" (4.8 cm) Weight 0.9 oz.
Overall Length 4.7" (11.9 cm) UPC 044356206730

- + 3Cr13MoV Stainless Steel
- + Clip Point Blade
- + Spey Blade
- + Stainless Steel Bolsters



IMPI8PT TRAPPER

Blade Length 2.2" (5.6 cm) Weight 1.4 oz.
 Overall Length 5.0" (12.7 cm) UPC 044356205566

- + 3Cr13MoV Stainless Steel
- + Clip Point Blade
- + Sheepfoot Blade
- + Spey Blade
- + Stainless Steel Bolsters



IMPI8PS STOCKMAN

Blade Length 1.8" (4.6 cm) Weight 1.1 oz.
 Overall Length 4.5" (11.4 cm) UPC 044356205573

- + 7Cr17MoV Stainless Steel
- + Drop Point Blade
- + Stainless Steel Bolsters



IMP22 FOLDER

Blade Length 2.7" (6.8 cm) Weight 2.1 oz.
 Overall Length 6.4" (16.2 cm) UPC 044356207171

- + 7Cr17MoV Stainless Steel
- + Drop Point Blade
- + Stainless Steel Bolsters

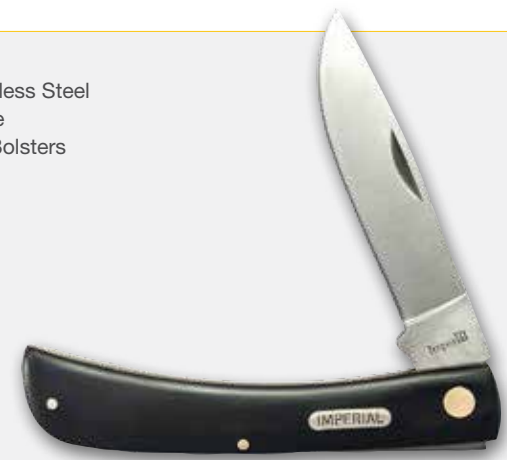

IMP22L LARGE FOLDER

Blade Length 3.6" (9.2 cm) Weight 3.5 oz.
 Overall Length 8.3" (21.1 cm) UPC 044356207188

- + 7Cr17MoV Stainless Steel
- + Drop Point Blade
- + Stainless Steel Bolsters



IMP22Y FOLDER

Blade Length 2.7" (6.8 cm) Weight 2.1 oz.
 Overall Length 6.4" (16.2 cm) UPC 044356207195

- + 3Cr13MoV Stainless Steel
- + Clip Point Blade
- + Pen Blade
- + Stainless Steel Bolsters



278 JACKMASTER BARLOW

Blade Length 2.4" (6.1 cm) Weight 2.3 oz.
 Overall Length 5.7" (14.5 cm) UPC 044356108032



Display included, orders of 12 only

- + 3Cr13MoV Stainless Steel
- + Plastic w/Rubber Insert Handle
- + Ambidextrous Thumb Hole
- + Lockback
- + Pocket Clip



IMP35 APEX

Blade Length 2.4" (6.0cm) Weight 1.2 oz.
 Overall Length 5.5" (14.0cm) UPC 044356224956

SS102

SAMPLER FRUIT

- + 3Cr13 Stainless Steel
- Blade Length 3.7" (9.4 cm)
- Overall Length 8.3" (21.1 cm)
- Weight 1.8 oz.
- UPC 044356005234



SS105

SAMPLER FRUIT LONG

- + 7Cr17MoV Stainless Steel
- Blade Length 4.7" (11.9 cm)
- Overall Length 10.5" (26.7 cm)
- Weight 2.6 oz.
- UPC 044356005241

IMPERIAL

IMPCOM5CP IMP35 COMBO PACK

NEW

3Cr13MoV Stainless Steel Blade
Plastic w/Rubber Insert Handle

- + Ambidextrous Thumb Hole
- + Lockback
- + Pocket Clip

Blade Length
2.4" (6.0 cm)
Overall Length
5.5" (14.0 cm)
Weight
1.2 oz.
UPC
044356229432

Only available in clam pack



IMP4SBCP SNOWBLIND® FOLDING KNIFE

NEW

3Cr13MoV Stainless Steel Blade
Aluminum & Rubber Handle

- + Ambidextrous Thumb Hole
- + Liner Lock
- + Pocket Clip

Blade Length
3.0" (7.6 cm)
Overall Length
7.0" (17.8 cm)
Weight
3.8 oz.
UPC
044356229425

Only available in clam pack



IMPCOM11CP SNOWBLIND® FOLDING KNIFE COMBO

NEW

3Cr13MoV Stainless Steel Blade
Aluminum & Rubber Handle

- + Ambidextrous Thumb Hole
- + Liner Lock
- + Pocket Clip

Blade Length
3.0" (7.6 cm)
Overall Length
7.0" (17.8 cm)
Weight
3.8 oz.
UPC
044356229777

Only available in clam pack



IMP100MCP IMPERIAL FOLDING KNIFE

NEW

IMPERIAL

3Cr13MoV S.S. Blade Aluminum Handle

- + Thumb Knob
- + Liner Lock
- + Pocket Clip

Blade Length
3.2" (8.1 cm)
Overall Length
7.3" (18.6 cm)
Weight
4.6 oz.
UPC
044356229685

Only available in clam pack



IMP100MBSCP IMPERIAL FOLDING KNIFE

NEW

IMPERIAL

3Cr13MoV S.S. Blade Aluminum Handle

- + Thumb Knob
- + Liner Lock
- + Pocket Clip

Blade Length
3.2" (8.1 cm)
Overall Length
7.3" (18.6 cm)
Weight
4.6 oz.
UPC
044356229692

Only available in clam pack



IMPCOM12CP IMPERIAL FOLDING KNIFE COMBO

NEW

3Cr13MoV S.S. Blade Aluminum Handle

- + Thumb Knob
- + Liner Lock
- + Pocket Clip

IMP100
Blade Length
2.6" (6.6 cm)
Overall Length
6.2" (15.7 cm)
Weight
2.8 oz.

IMP100LBS
Blade Length
3.8" (9.5 cm)
Overall Length
8.6" (21.8 cm)
Weight
6.1 oz.



IMPCOM12CP Clam Pack
UPC 044356229784



+ IMP100



+ IMP100LBS

Only available in clam pack

IMPCOM6CP IMPERIAL FOLDING KNIFE COMBO

NEW

3Cr13MoV High Carbon S.S. Blades Plastic Handles

- + Lockback
- + Lanyard Hole

SP1
Blade Length
2.1" (5.3 cm)
Overall Length
4.3" (10.9 cm)
Weight
1.7 oz.

SP2
Blade Length
2.5" (6.4 cm)
Overall Length
5.4" (13.7 cm)
Weight
2.3 oz.

SP3
Blade Length
3.0" (7.6 cm)
Overall Length
6.6" (16.8 cm)
Weight
2.8 oz.



IMPCOM6CP Clam Pack
UPC 044356229449



+ SP1

+ SP2

+ SP3

Only available in clam pack

IMP101TCP IMPERIAL FOLDING KNIFE

NEW

IMPERIAL

3Cr13MoV S.S. Blade Rubberized Aluminum Handle

- + Dual Thumb Knobs
- + Liner Lock
- + Pocket Clip

Blade Length
2.6" (6.6 cm)
Overall Length
6.4" (16.3 cm)
Weight
3.3 oz.
UPC
044356229791

Only available in clam pack



IMP102CP IMPERIAL FOLDING UTILITY BLADE

NEW

IMPERIAL

3Cr13MoV S.S. Blade Rubberized Aluminum Handle

- + Dual Thumb Knobs
- + Liner Lock
- + Razor Blade
- + Strap Cutter
- + Pocket Clip

Blade Length
2.8" (7.0 cm)
Overall Length
7.2" (18.2 cm)
Weight
5.2 oz.
UPC
044356229807

Only available in clam pack



IMP104BCP IMPERIAL FOLDING KNIFE

NEW

3Cr13MoV S.S. Blade Rubberized Aluminum Handle

- + Dual Thumb Knobs
- + Liner Lock
- + Pocket Clip

Blade Length
3.4" (8.5 cm)
Overall Length
7.9" (20.0 cm)
Weight
4.3 oz.
UPC
044356229821

Only available in clam pack



IMP105BSCP IMPERIAL LOCKBACK

NEW

3Cr13MoV S.S. Blade Rubberized Aluminum Handle

- + Dual Thumb Knobs
- + Lockback
- + Pocket Clip
- + Polyester Sheath

Blade Length
3.4" (8.5 cm)
Overall Length
8.1" (20.5 cm)
Weight
6.0 oz.
UPC
044356229838

Only available in clam pack



IMP103CP IMPERIAL FOLDING UTILITY BLADE

NEW

3Cr13MoV S.S. Blade Rubberized Aluminum Handle

- + Dual Thumb Knobs
- + Liner Lock
- + Pocket Clip

Blade Length
3.4" (8.7 cm)
Overall Length
8.1" (20.5 cm)
Weight
6.0 oz.
UPC
044356229814

Only available in clam pack



IMPERIAL

IMPFI1CP IMPERIAL FIXED BLADE

NEW

3Cr13MoV S.S. Blade Rubberized Aluminum Handle

- + Full Tang
- + Spine Drywall Saw
- + Polyester Belt Sheath

Blade Length
5.2" (13.3 cm)
Overall Length
10.0" (25.4 cm)
Weight
7.3 oz.
UPC
044356229845

Only available in clam pack



IMPCOM9CP IMPERIAL SP3 & MULTI-TOOL COMBO

NEW

Multi-Tool
17 Features

- + Needle Nose Plier
- + Regular Pliers
- + Wire Cutter
- + Wire Strippers
- + Fine Edge Blade
- + Small Phillips Head
- + Can Opener/Bottle Opener/Scraping Blade
- + Fine Flat Head Screwdriver
- + Saw/Nail Puller
- + Fine Grit File/Large Flat Head Screwdriver
- + Awl
- + Small Flat Head Screwdriver
- + Locking Tools
- + Polyester Belt Sheath

Closed Length
4.2" (10.7 cm)
Overall Length
6.3" (16.0 cm)
Weight
10.5 oz.

Only available in clam pack



IMPCOM9CP Clam Pack
UPC 044356229487



SP3 Lockback

- + 3Cr13MoV Stainless Steel
- + Plastic Handle

Blade Length
3.0" (7.6 cm)
Overall Length
6.6" (16.8 cm)
Weight
2.8 oz.



IMPCOM10CP TRADESMAN TM1 & TM2 COMBO

NEW

3Cr13MoV High Carbon S.S. Blades Plastic Handles

- + Lockblade
- + Screwdriver Tip
- + Shackle

TM1 Hawkbill

Blade Length
3.0" (7.6 cm)
Overall Length
7.1" (18.0 cm)
Weight
2.2 oz.

TM2 Electrician

Blade Length
2.7" (6.9 cm)
Overall Length
8.4" (21.3 cm)
Weight
2.2 oz.

Only available in clam pack



IMPCOM10CP Clam Pack
UPC 044356229456



TRADESMAN

QUALITY CUTTING TOOLS

SCTS3

Overall Length
3.0" (7.6 cm)
Weight
2.4 oz.
UPC
044356227094

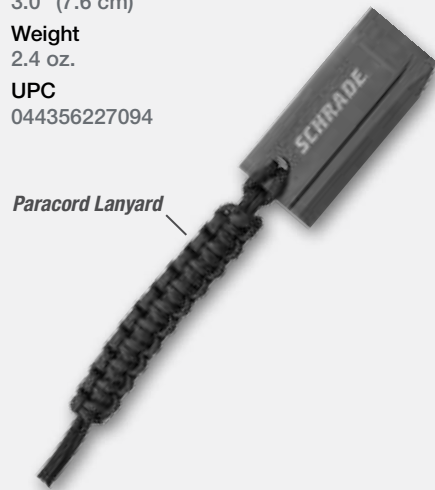

Paracord Lanyard

SCTS4

Overall Length
4.0" (10.2 cm)
Weight
3.1 oz.
UPC
044356227100



SCTS6

Overall Length
5.8" (14.7 cm)
Weight
4.9 oz.
UPC
044356227117



**HARD ARKANSAS
TACTICAL SHARPENING STONES**

DH40T

OLD TIMER® USA SPORTSMAN'S HONING SET

- + Mounted Soft/Hard Arkansas Stones
- + 1 oz. Bottle Premium Honing Oil

Overall Length
8.4" (21.3 cm)
Weight
9.9 oz.
UPC
044356227070



+ Soft Arkansas Stone

+ Hard Arkansas Stone

TH6UH

6" TRI-HONE

- + Three Stones: Coarse/Medium/Fine
- + 1 oz. Bottle Premium Honing Oil

Overall Length
8.1" (20.6 cm)
Weight
1 lb. 14.0 oz.
UPC
044356227124



TH8UH

8" TRI-HONE

- + Three Stones: Coarse/Medium/Fine
- + 1 oz. Bottle Premium Honing Oil

Overall Length
10.1" (25.8 cm)
Weight
2 lb. 8.2 oz.
UPC
044356227131



+ 360/600 Grit

SCHDDFSCP DOUBLE SIDED DIAMOND DUST SHARPENER

Overall Length 8.9" (22.7 cm) UPC 044356229630
Weight 2.3 oz.



+ 180 Grit

SCHDDS DIAMOND DUST SHARPENING STONE

Sharpening Rod 3.3" (8.4 cm) UPC 044356000253
Handle Length 1.4" (3.6 cm) **SCHDDSCP CLAM PACK**
Weight 1.2 oz. UPC 044356000277



SCTHB

SCHRADE® USA WHET-HONE PRO 3-WAY SHARPENING SYSTEM

- + Three Stones:
 - + Coarse Silicon Carbide
 - + Medium Silicon Carbide
 - + Fine Aluminum Oxide
- + ABS Plastic Oil Well Box w/Cover
- + Two, 3 oz. Bottles Premium Honing Oil

Overall Length
11.3" (28.6 cm)
Weight
2 lb. 7.1 oz.
UPC
044356227087



+ 180/320 Grit

SSOTCP DOUBLE SIDED SHARPENING STONE

Overall Length 6.0" (15.2 cm) UPC 044356218924
Weight 1 lb. 0.4 oz.

HSI OLD TIMER® HONESTEEL

Overall Length 7.0" (17.8 cm) UPC 044356209649
Weight 6.2 oz.



SCHRADE® PREMIUM QUALITY LEATHER SHEATHS

CARRY WITH STYLE AND CONFIDENCE. EVERY SCHRADE, UNCLE HENRY AND OLD TIMER PREMIUM LEATHER SHEATH HAS BEEN WELL-CRAFTED TO ENSURE YOUR KNIFE IS KEPT PROTECTED THROUGH THE TOUGHEST SITUATIONS.



LS1 / **OLD TIMER® LEATHER SHEATH**

Overall Length 4.4" (11.1 cm) UPC 044356201667
Weight 1.6 oz.



LS3 / **OLD TIMER® LEATHER SHEATH**

Overall Length 3.4" (8.7 cm) **LS3CP CLAM PACK**
Weight 0.4 oz. UPC 044356224857
UPC 044356224178



LS2 / **OLD TIMER® LEATHER SHEATH**

Overall Length 5.8" (14.7 cm) UPC 044356201674
Weight 1.9 oz.



LS4 / **OLD TIMER® LEATHER SHEATH**

Overall Length 3.9" (9.8 cm) **LS4CP CLAM PACK**
Weight 0.7 oz. UPC 044356224864
UPC 044356224185

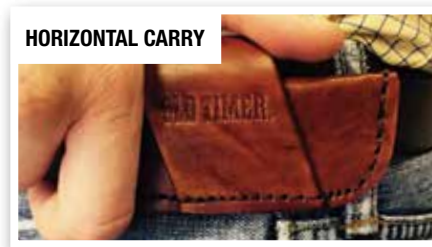

LS5 / **OLD TIMER® LEATHER SHEATH**

Overall Length 3.8" (9.7 cm) **LS5CP CLAM PACK**
Weight 0.88 oz. UPC 044356224871
UPC 044356224444



NEW

LS56/LS56L / **SCHRADE® LEATHER SHEATHS**

LS56 (For SCHRADE® SCHF56)	LS56L (For SCHRADE® SCHF56L)
Overall Length 8.2" (20.8 cm)	Overall Length 9.2" (23.3 cm)
Weight 3.1 oz.	Weight 3.2 oz.
UPC 044356228558	UPC 044356228565



NEW

LS6 / **UNCLE HENRY® LEATHER SHEATH**

Overall Length 5.9" (15.0 cm) UPC 044356228299
Weight 2.4 oz.



SNYLON / **SCHRADE® POLYESTER BELT SHEATH**

Overall Length 5.7" (14.4 cm) UPC 044356200493
Weight 1.2 oz.

+ SCH550BK



+ SCH550GR



+ SCH550BKGR



SCSK1 Includes

- + Waterproof Case
- + 2 - Needles
- + Compass w/Whistle
- + 2 - Fishing Hooks
- + 6 - Matches
- + 2 - Split Shots
- + Match Strike
- + Fishing Line

SCHRADE 550 PARACORD BRAIDED LANYARD

SCH550BK	SCH550GR	SCH550BKGR
UPC 044356224451	UPC 044356224475	UPC 044356224468

SCSK1 SCHRADE® SURVIVAL KIT

Overall Length	3.4" (8.7 cm)	UPC	044356223287
Weight	1.1 oz.		

OLD TIMER®

- OTD1 (Window Decal)
- UPC 044356221881
- OTS1 (Sticker)
- UPC 044356223812

SCHRADE®

- SCHD1 (Window Decal)
- UPC 044356221867
- SCHS1 (Sticker)
- UPC 044356223799

UNCLE HENRY®

- UHD1 (Window Decal)
- UPC 044356221874
- UHS1 (Sticker)
- UPC 044356223805

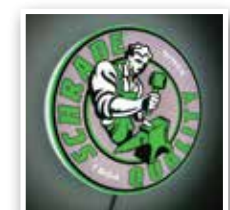

+ UL Approved
+ 110 Volt



SCHRADE 6" WINDOW DECALS & STICKERS

SCHQSI SCHRADE® 12W LED SIGN

UPC	044356224161
-----	--------------



Striker Plate



NEW

SCHFS1 FERRO ROD FIRE STRIKER

Overall Length	4.0" (10.1 cm)	UPC	044356221016
Weight	1.1 oz.		

SCHFS2 LARGE FERRO ROD

Overall Length	6.0" (15.2 cm)	UPC	044356229616
Weight	3.9 oz.		



+ FR2



+ FR4

FR2
Overall Length
1.6" (4.1 cm)
Weight
0.2 oz.

+ RST



+ FR3



FR2/FR4 REPLACEMENT FERRO RODS

FR2 (Replacement SCPEN4 Series)	FR4 (Removable Attachment)
UPC 044356221443	UPC 044356227780

RST/FR3 SLINGSHOT TUBING/FERRO ROD

RST (Replacement for SCHF39)	FR3 (Replacement for SCHF39)
UPC 044356226042	UPC 044356226059

+ Schrade® Header For TBD1
HSC UPC 044356224154



MAGNETIC DISPLAY



TBD1 ROTATABLE COUNTER DISPLAY

UPC	044356224079
-----	--------------

SCHRADE PLEXIGLASS DISPLAYS

PLEXBR (Resting Display)	PLEXSD (Standing Display)
UPC 044356224055	UPC 044356224048



SC204 - Panel 1

UPC 044356217613

- | | |
|------|--------|
| 44OT | 80T |
| 120T | 330T |
| 30T | 1080T |
| 340T | 10110T |
| 770T | 110T |
| 940T | 8580T |
| 50T | 90T |



SC204 - Panel 2

UPC 044356217620

- | | |
|-------|-------|
| 11UH | 804UH |
| 834UH | 285UH |
| 12UH | 16UH |
| 124UH | 5UH |
| 885UH | LB5 |
| 877UH | LB7 |
| 897UH | |



SC204 - Panel 3

UPC 044356217637

- | | |
|------|-------|
| 44OT | LB5 |
| 120T | 80T |
| 30T | 12UH |
| 940T | 897UH |
| 330T | 11UH |
| 340T | 124UH |
| 5UH | 285UH |



SC204 ROTATING COUNTER DISPLAY

UPC 044356217606



SC500 FLOOR DISPLAY

UPC 044356217644

DISPLAY UNITS

- + Vacuum formed panels
- + Each display utilizes steel panels with movable magnets for product placement
- + **SC204** Two-sided rotating display with lockable inside storage
- + **SC500** Lockable display with inside storage

SC500 - Panel 1

UPC 044356217651

- | | |
|-------|-------|
| 44OT | 80T |
| 1250T | 330T |
| 30T | 1080T |
| 340T | 180T |
| 770T | 110T |
| 940T | 8580T |
| 50T | 690T |



SC500 - Panel 2

UPC 044356217668

- | | |
|-------|-------|
| 834UH | 877UH |
| 897UH | 285UH |
| 885UH | 124UH |
| 707UH | 5UH |
| 11UH | LB5 |
| 16UH | LB7 |
| 804UH | |



SC500 - Panel 3

UPC 044356217675

- | | |
|-------|-------|
| 1580T | 510T |
| 1520T | 1560T |
| 1650T | 227UH |
| 1600T | 162UH |
| 150T | 153UH |



SC500 - Panel 4

UPC 044356217682

- | | |
|-------|--------|
| 180T | 897UHP |
| 1080T | 12UH |
| 940T | 834UH |
| 440T | 285UH |
| 80T | 885UH |
| 50T | LB7 |
| 124UH | |



SC500 - Panel 5

UPC 044356217699

- | | |
|-------|-------|
| 770TW | 30T |
| 340TW | 330T |
| 940TW | 11UH |
| 440TY | 340T |
| 940TY | 5UH |
| 80TY | LB5 |
| 8580T | 897UH |



SCHRADE® CUSTOM LASER ETCHING

BTI TOOLS, LLC PROUDLY OFFERS THE ABILITY TO CUSTOM LASER AND CREATE FULL COLOR INSERTS ON A WIDE RANGE OF PRODUCTS.



SCHRADE® FULL COLOR INSERTS

WE CAN CREATE A FULL COLOR INSERT USING YOUR EXISTING ARTWORK OR LET OUR TEAM OF EXPERIENCED ARTISTS CREATE SOMETHING NEW AND UNIQUE ESPECIALLY FOR YOU.

SCH206, SCH207, SCH208 & SCH209 MODELS ONLY. SMALL MINIMUM ORDERS.



+ SCH206



+ SCH207



+ SCH208



+ SCH209

General Care/Use Instructions

Your cutting tool is produced from the highest quality materials by expert craftsmen and with reasonable care it will serve you faithfully for a lifetime. Below is general information concerning the use and care for your item.

FIXED & FOLDING BLADE KNIVES:

The primary defenses against wear, corrosion and potential injury are to keep your knife sharp, oiled, clean and dry. Proper care of your knife will help to extend the life of the product as well as increase its reliability and durability. Always keep your knife clean. Be sure to clean the handle and blade of the knife after each use. A mild solution of water and soap should remove any debris and dirt that would have accumulated during use (always avoid harsh detergents such as dish soap, and chlorine products).

After cleaning your knife always make sure it is then dried (always keep your knife dry when possible). Please always take special care with sensitive handle materials such as leather. We recommend using a soft dry cloth and a small amount of water-displacing oil (we recommend WD-40 or 3-in-1), to apply to the blade, this will help prevent water spots as well as retard rusting and oxidation.

We recommend always keeping your knife oiled. Weather and fingerprints are the main causes of corrosion and rusting on a knife blade. You should always give your blade a light coat of oil after each cleaning and prior to long term storage. If you choose to store you knife for extended periods of time it is recommended to use a desiccant to remove moisture from the air. Stainless steel does not stain, corrode, or rust as easily as ordinary steel, but it is not stain-proof and will rust without proper maintenance.

Always keep your knife as sharp as possible because a sharp knife is easier to work with and safer to use than a dull one. Fixed-angle sharpening kits are available and recommended if you are new to sharpening blades, a consistent grind from tip to base is necessary to properly sharpen you knife (please note that damage to your blade from home-sharpening is not covered by our warranty).

While not in use you should oil and store your blade in a cardboard scabbard type of sheath. Never store the knife in a leather/nylon/Kydex® sheath (even if the knife comes in these type of sheaths) as these sheaths can retain moisture which will accelerate the rusting/oxidation process. A cardboard sheath will wick moisture away from the blades surface as well as help to prevent debris and dust from accumulating. For best results a low moisture/humidity room-temperature environment is preferred for storage. The blade should be re-oiled periodically during this period. Remember that all steels will eventually rust/oxidize but that with proper maintenance you should experience reliability and longevity on your product throughout the years.

MULTI-TOOLS:

BTI Tools LLC recommends regular maintenance and upkeep on your multi tool. For maximum benefit on the life of the product you should regularly clean and dry your multi-tool after use. When necessary, use a light oil to oil the pivot points. Always be sure to clean the handle set and blade after each use. A mild solution of water and soap should remove any debris and dirt that would have accumulated during use (always avoid harsh detergents such as dish soap, and chlorine products). We do not recommend fully immersing the tool in water. To remove debris from inside the handle you can use a Q-Tip or toothpick. A can of compressed air also can be useful for cleaning these hard to reach areas (please always read the instructions and warnings on the compressed air can as some of these products use an accelerant which could damage the products finish). After exposure to salt water or if extremely dirty please first rinse the tool in fresh water or with a mild solution of water and soap then completely dry with a soft cloth. Next apply a desiccant (drying agent) or a light coat of water-displacing oil (we recommend WD-40 or 3-in-1). Finally wipe down and lightly lubricate the tool's surface and pivot points. This process should remove any debris and dirt which could inhibit the tool's functioning but should also help to prevent rusting and oxidation on the surface steel. It is not recommended that you store the tool in a pouch or sheath for long periods of time, moisture can remain trapped in the fabric of the sheath/pouch and or tanning oils in leather sheaths might accelerate rusting and oxidation.

CONSUMER AWARENESS STATEMENT:

The blades that go into every cutting tool are extremely sharp. Be very cautious when opening, using or sharpening this product. Cutting tools are intended to be used as working tools, they are not weapons and should not be used as such. If an injury occurs during the use (or misuse) of a BTI Tools cutting tool, this is a risk that our customers assume and BTI Tools can in no way be held accountable. Locking systems such as liner locks, safeties, frame locks and lock back mechanisms are added features designed to help keep blades in the open position when fully extended. These systems are not designed to take pressure or blows to the backside (dull side) of the blade and failure of these systems can happen when not used properly. When a cutting tool is used properly the cutting pressure exerted on the blade will always be against the cutting edge of the blade pushing and keeping the blade in the open position, when used properly it is not possible for the blade to close when in use.

NOTE: Not all cutting tool have blades that lock in the open position. If you have purchased a cutting tool with a locking blade please see the instructions below:

HOW TO CLOSE LOCKING KNIVES

LOCKBACK KNIVES: Hold the knife open with the blade pointing down. Depress the lock firmly with your thumb to release the locked blade. Then with your other hand ease the blade into the closed position.

LINER LOCK OR FRAME LOCK MECHANISMS: Carefully hold the knife and move the liner or frame lock to the side to release the locked blade. With your other hand ease the blade towards the closed position. Make sure your handle is clear of the blade's path, slowly close the blade the rest of the way.

Misuse of your product can cause serious injury or even death. Misuse often will result in a product failing and breaking in which cases the BTI Tools warranty will not apply. Failure to properly maintain your product may cause it's mechanisms to not function properly and could also result in injury to you and/or damage to your product.

Use with approved eye protection to protect from debris. Flying debris can result in eye or other injury. Use cutting edge for cutting wood only. Contact with hard object can result in blade or head chipping.

Do not use to strike with or against another tool, hardened nail, or other object. Do not use if blade is dull, chipped, or otherwise damaged or if handle is broken or loose. Blade is sharp. Handle with Care. Contact with blade can result in injury. When not in use, store in safe place.

Caution: This is not a toy, keep away from children.

RELEASE, ASSUMPTION OF RISK, WAIVER OF LIABILITY AND INDEMNITY AGREEMENT

By purchasing any item produced by BTI Tools LLC the buyer assumes responsibility to ascertain and follow all applicable international, federal, state and local laws in owning, carrying, having, shipping, transporting and using any BTI Tools LLC product. The buyer expressly agrees to indemnify and hold harmless BTI Tools LLC for all claims resulting directly or indirectly from the ownership, purchase, transportation or use of the item in violation of applicable federal, state and local laws or regulations. BTI Tools LLC is not liable for misuse of any BTI Tools LLC product purchased either directly from BTI Tools LLC or from a dealer/distributor. You must be 18 years of age to purchase BTI Tools LLC products. BTI Tools LLC warranty gives you certain legal rights. You may have other rights, which vary in different states and municipalities.

Warranty Information

BTI TOOLS LLC LIMITED LIFETIME WARRANTY FOR CUTTING TOOLS

This product is warrantied to the original consumer purchaser, for as long as he or she owns this product. Coverage ends if you transfer or sell the product to someone else or if the product is modified in any way. The warranty covers defects in materials, manufacture or assembly. If one of our products ever breaks or fails due to material or manufacturing defect we will repair or replace the product.

The warranty does not cover normal wear, damage caused by abuse, misuse, improper handling, loss, accident, alterations, neglect, disassembly or improper sharpening. Cosmetic damage which occurs over time and use, such as scratches on a products finish or coatings on a product rubbing or wearing off are normal and are not covered by the warranty. Our products rarely fail because of a defect and in most cases the failure or breakage is due to “tool abuse”. “Tool abuse”, is when the product is used for unsuitable non intended purposes. Examples would be using a knife for any other purpose than cutting (pounding, prying, using as a screw-driver, throwing the knife etc). Multi-purpose tools are not intended to replace full-sized tools and are for use only on light or moderately heavy-duty applications. Collapsible batons are not pry bars etc. Always use the proper tools for the proper intended purposes.

Locking systems such as liner locks, safeties, frame locks and lock back mechanisms are added features designed to help keep the blade in the open position when fully extended. These systems are not designed to take pressure or blows to the backside (dull side) of the blade and failure of these systems can happen when not used properly. When a cutting tool/knife is used properly the cutting pressure exerted on the knife blade will always be against the cutting edge of the blade pushing and keeping the knife blade open, when used properly it is impossible for the knife to close when cutting.

Misuse of your product can cause serious injury or even death. Misuse often will result in your product failing and breaking in which cases the BTI Tools warranty will not apply. Failure to properly maintain your product may cause it’s mechanisms to not function properly and could also result in injury to you and/or damage to your product. All natural materials such as Buffalo Horn, Sheep Horn, Mother of Pearl, Pickbone, Stag Horn, etc. are subject to natural processes such as cracking over time and are not covered by this warranty.

INTERNATIONAL CUSTOMERS

Please take your item(s) to your local dealer where the product was purchased, ask that they contact BTI Tools LLC with regard to your defective item and BTI Tools LLC will include replacement parts or a replacement item on their next shipment of goods to our authorized distributor in your area. If you are unable to find a dealer or distributor in your area we ask that you send your item in for repair/replacement to our facilities following the normal warranty procedure with the exception that the cost of shipping may be adjusted upon receipt of the item in order to cover return shipping to your out of country location.

THE BTI TOOLS LLC ACCESSORY WARRANTY

BTI Tools LLC has a one (1) year limited warranty which covers defects in materials, manufacture or assembly. The warranty does not cover normal wear, damage caused by abuse, misuse, improper handling, loss, accident, alterations, neglect or disassembly on any accessories including but not limited to sheaths, sharpeners, tactical pens and carry and deployment systems. Proof of purchase may be required.

Any accessories falling under this limited warranty must be returned for evaluation.

THE BTI TOOLS COLLAPSIBLE BATON WARRANTY

All BTI Tools LLC expandable batons are warranted to the original consumer purchaser, for as long as he or she owns this product. Coverage ends if you transfer or sell the product to someone else or if the product is modified in any way. This warranty covers defects in materials, manufacture or assembly and includes a repair or replacement guarantee, under normal field use, against breaking, bending, torn grip and if rust or corrosion prevents the batons from functioning. This warranty covers defects in materials, manufacture or assembly. If one of our products ever breaks or fails due to material or manufacturing defect we will repair or replace the product.

The warranty does not cover normal wear, damage caused by abuse, misuse, improper handling, loss, accident, alterations, neglect or disassembly. Cosmetic damage which occurs over time and use, such as scratches on a products finish or coatings on a product rubbing or wearing off are normal and are not covered by the warranty.

Any batons falling under this limited warranty must be returned for evaluation.

Trademarks and Patents

PATENT INFORMATION

The products of BTI Tools LLC, Kingsport, Tennessee may be covered by one or more of the following United States utility and design patents (other patents pending):

Utility: 6308420, 6550142, 6651344, 6810588, 7111402, 7797838, 8348539, 8595941, 8967899

Design: D469365, D469366, D482257, D482258, D505057, D512624, D519018, D539616, D539631, D554964, D560460, D561295, D561554, D562102, D562932, D578857, D599640, D599641, D600090, D613145, D613438, D627852, D630292, D632154, D632539, D632755, D646324, D647562, D647563, D647963, D651647, D652081, D660676, D670149, D685848, D688933, D689934, D692289, D692480, D706605, D733515, D734117, D737111, D746922, D768454, D768455, D768456, D768457, D768458, D768459, D769694

TRADEMARK INFORMATION

The following are pending, registered and/or common law trademarks & associated logos of Battenfeld Technologies INC., and BTI Tools LLC, Kingsport, Tennessee: (Alphabetically):

1ST RESPONSE	GUN BUTLER	SCHRADE EXTREME SURVIVAL
24/7	H.R.T.	SCHRADE OLD TIMER
ADVANT-EDGE	HAMMER BRAND	SCHRADE TOUGH
AMMO VAULT	HOMELAND SECURITY	SCHRADE UNCLE HENRY
AQUANAUT	HOOYMAN	SCHRADE UP
BATTENFELD TECHNOLOGIES, INC.	IMPERIAL	SCHRADE WALDEN
BLACK OPS	JACK-MASTER	SCHRADE WATER RAT
BLAZE THE NEW TRAIL	JETHRO	SCHRADE WESTERN EDGE
BOGGEAR	LA CUISINE	SEARCH & RESCUE
BOG-POD	LAND SHARK	SEASWEPT
BOMB TECH	LEROY	SHARPFINGER
BONEYARD	LITTLE PAL	SHASTA MC'NASTY
BORDER GUARD	LITTLE RICKY	SHIZNIT
BR PIVOT	LOCKDOWN	SHIZZLE
BULLSEYE	LONG LIVE THE BLADE	SOLSTAR SMART LIGHT
CALDWELL	M.A.G.I.C.	SPEC OPS
CAPYBARA	MAG CHARGER	SPECIAL OPS
CHEROKEE	MAGNUM RIFLE GONG	SPECIAL TACTICAL
CLIPHANGER	MANILLA FOLDER	SPLINTER
COLORSHIFT	MOE	STABLE TABLE
CUTTIN' HORSE	M-SAT MULTI-SWITCH ADVANCED TECHNOLOGY	STAGLON
DEADSHOT	NEEDLE	STRONGER THAN ALL
DELTA FORCE	NEW YORK KNIFE CO.	SURE-LOCK
DELTA SERIES	NITRO	SWITCH-IT
DSS	NON-TYPICAL WILDLIFE SOLUTIONS	TAYLOR BRANDS
DSS-DISTANCE SEEKING SENSOR	NXT	TAYLOR BRANDS LLC
DURA EDGE	OASIS	TEXAS HOLD 'EM
ELK HORN	OLD TIMER	THE LEAD SLED
ELK HUNTER	ORANGE PEEL	THE RANCHER
E-MAX	OUTBACK	TIDBIT
EVERLASTINGLY SHARP	OWL HEAD	TIPTON
EXTRACTION & EVASION	PHANTOM	TRACTOR UP
EXTREME OPS	POCKET PROTECTOR	TRADESMAN
F.A.T. WRENCH	POSI-LOCK	ULSTER
FAJEN	PRISCILLA	ULTRA GLIDE
FIELD HAND	PRO HUNTER	UNCLE HENRY
FIELD SKINNER	PROFESSIONALS	URBAN TITANIUM CAMO
FIELDPOD	QUE-N-SKEW	VERI-SHARP
FIRE CONTROL	RAPSCALLION	VIPER
FRANKFORD ARSENAL	RELY ON YOU	WALDEN KNIFE CO.
FRONTIER	S.O.R.T.	WESTERN EDGE
GALAXY	S.W.A.T.	WHEELER
GALAXY GREEN BEAM	SAFE-T-GRIP	WHIPPERSNAPPER
GOLDEN BEAR	SAFE-T-LOCK	XLA BIPOD
GOLDEN ROD	SAINT HUBERTUS	X-TIMER
GRIP A LEGEND	SCHRADE	ZYLITE
GUIDE-MASTER	SCHRADE CLIPHANGER SYSTEM	

Associated product configurations and designs including the registered designs/product configurations of U.S. Reg. Nos. 2,984,344, 3,506,417, 3,691,152, and 3,368,278.

Steel Information

Steel is a critical component of any knife. The purpose of this guide is to provide a more detailed look into steel to help assist you in better defining what your own preferences are and why. As a word of caution this information is not intended to be all-inclusive nor could it ever be as the world of steel is ever evolving. The quest for higher performance steels has led to the development of many new excellent materials over the years and there are currently over 3,000 different types of steel, each having its own positive and negative attributes.

Of course steel is not the only factor that determines a knife's performance. Blade geometry, heat treatment processes, handle geometry, and other materials used in the production of the knife all contribute to how the end product will handle particular jobs. It is not possible to tell just by looking at a blade how well the item has been heat treated and it is only possible to make an educated guess as to how well the handle and blade geometry will work. However by knowing the grade of steel used you are better able to understand the alloying elements involved giving you something measurable to go by when determining your own preferences.

The result of knowing the grade of steel can unfortunately sometimes put the end user into a trap of placing too much of an emphasis on the steel itself. A knife is more than just the steel that goes into it and its important to recognize this. In fact so many modern steels perform so well that knife decisions can often be made based on other factors than just the marginal increases in steel performances.

Often the question of “what’s the best steel” or “which steels rank better than others in terms of best to worst” come up. There is never a truly correct and accurate response to this as the blade geometry of the product, the quality of the heat treatment, the materials used, and the tasks or goals of the end user all will factor in to determine how well a product will perform and in turn how well the user will be satisfied with the product.

BTI Tools uses specific blade steels to create the most efficient balance of properties based on the anticipated applications of our products.

Steel is an alloy of iron, other metals, and carbon. Stainless steel refers to a family of corrosion-resistant alloy steels which contain of a minimum of 10.5% chromium. A common misconception is that stainless steels will not stain, rust, or corrode. Stainless steels will simply stain less than other steels that do not contain chromium. Each alloy in the various steels lends unique properties to the stainless steel.

When selecting the steel for the various products we factor in the overall performance requirements of what the tool will be used for, the goal price range for the end product, and the costs of manufacturing and finishing the item(s). As with any materials there are generally trade-offs. For instance while higher alloy levels and final hardness levels keep an edge longer they also will make it more difficult to field sharpen a blade. Some alloys can be found to be low in nickel, which will result in increased staining if not kept regularly oiled and cleaned after use. Knives that will be placed to hard use must be constructed with very tough steel materials so we will use steels that are considered to have high ductility (or toughness) over a higher hardened steel. Please note that final hardness levels are achieved not only by factors of composition but from proper heat treating and quenching, of which we pay great attention.

BTI Tools sources premium steel from many international suppliers. The information chart referenced below shows a reasonable range of the compositions of the various steels we utilize. The blade steel we use for each product is included in the catalog to help make this information easy for you to locate.

STEEL TERMS

Alloy: A material that is dissolved in another metal in a solid solution. A material that results when two or more elements combine in a solid solution.

Corrosion Resistance: The ability of a material to resist deterioration as a result of a reaction to its environment. Provided by the elements Chromium (Cr), Copper (Cu), Molybdenum (Mo), and Nitrogen (N).

Ductility: The ability of a material to be stretched or drawn, plastically deform appreciably before fracturing. Provided by the element Manganese (Mn).

Edge Retention: The ability of a material to resist abrasion and wear. Provided by the elements Carbon (C), Chromium (Cr), Manganese (Mn), Nitrogen (N), and Vanadium (V).

Hardness: The resistance of a steel to deformation or penetration analogous to strength. Provided by the elements Carbon (C), Chromium (Cr), Cobalt (Co), Molybdenum (Mo), Nitrogen (N), and Phosphorus (P).

Hardenability: The ability of a steel to be hardened by a heat treating process. Provided by the elements Manganese (Mn), Molybdenum (Mo), and Tungsten (W).

Heat Treating: A controlled heating and cooling process to prescribed temperatures and set limits for the purpose of changing the physical properties and behavior of the metal.

Impact Strength: The ability of a material to resist cracking due to a sudden force.

Rockwell Test (HRC): A measurement of steel hardness based on the depth of penetration of a small diamond cone pressed into the steel under a constant load.

Tensile Strength: Indicated by the force at which a material breaks due to stretching. Provided by the elements Chromium (Cr) and Manganese (Mn).

Toughness: The ability of a material to resist shock or impact. Provided by the element Chromium (Cr).

KNIFE STEEL SELECTION CHART

1070: This is a plain carbon steel which means it has a low resistance to corrosion and low to medium edge retention. The benefit of this steel is that it is very easy to sharpen and will take an extremely sharp edge.

1095: This is a plain carbon steel which means it has a low resistance to corrosion and low to medium edge retention. The benefit of this steel is that it is very easy to sharpen and will take an extremely sharp edge.

4034: A good quality grade of stainless steel. This steel is known for its ability to be honed to a razor sharp edge. While this steel has medium edge retention it is a very easy steel to field sharpen. A choice steel to use for an everyday carry product.

4116: A fine grained stainless steel. The balance of carbon and chromium content give it a high degree of corrosion resistance and also impressive physical characteristics of strength and edge holding. Edge retention in actual cutting tests exceeded blades made of 420 and 440 series of stainless steels. Other alloying elements contribute to grain refinement which increase blade strength and edge toughness and also allow for a finer, sharper edge.

420J2: A good quality stainless steel commonly used in knife blades as well as for impact cutting tools such as axes, hatchets, and machetes. Known as a hard, strong steel, this steel has decent edge holding capabilities and is easy to resharpen, sticking a good balance of the most desirable traits for knife steel.

2Cr13: A good quality stainless steel commonly used in knife blades as well as for impact cutting tools such as axes, hatchets, and machetes. Known as a hard, strong steel, this steel has decent edge holding capabilities and is easy to resharpen.

3Cr13: A good quality stainless steel commonly used in knife blades as well as for impact cutting tools such as axes, hatchets, and machetes. Known as a hard, strong steel, this steel has decent edge holding capabilities and is easy to resharpen, sticking a good balance of the most desirable traits for knife steel.

7Cr17MoV: A good quality stainless steel that has a high tensile strength. This steel has excellent corrosion resistance and can be honed to a razor sharp edge.

8Cr13MoV: A high quality stainless steel similar in properties to AUS-8. This steel exhibits extreme toughness and excellent edge retaining capabilities.

9Cr14MoV: A high quality stainless steel. This steel has good corrosion resistance and excellent edge retaining capabilities.

9Cr18MoV: A higher end stainless steel commonly used in precision surgical instruments. This steel has good corrosion resistance and excellent edge retaining capabilities.

AUS-8: A very high quality stainless steel known for extreme toughness and excellent edge retaining capabilities. This steel has great corrosion resistance and is easy to sharpen.

D2: An air hardened tool steel. Sometimes called a “semi-stainless” steel because it does contain 12% Chromium. This steel offers exceptional edge retention as well as decent corrosion resistance. Somewhat difficult to sharpen this steel can be finished to a high polish shine.

SK5: The Japanese equivalent of American 1080 steel, a high carbon steel with carbon between 0.75%-0.85% and 0.60%-0.90% manganese. This grade of steel has an ideal balance of very good blade toughness with superior edge holding ability and is used in a variety of hand tools and cutting products.

S30V: This steel contains carbon along with high amounts of chromium, molybdenum, and vanadium. Double tempered for hardness and edge retention this steel has excellent corrosion resistance but is somewhat difficult to sharpen.

Ceramic: A ceramic is an inorganic, nonmetallic solid prepared by the action of heat and subsequent cooling. When used in the application of a knife blade the ceramic material will stay sharp for much longer than that of a steel knife. The only drawback is the ceramic material is more brittle than steel and can snap from a hard impact.

Stainless Steel Alloy Specifications													
Steel	HRC	C	CR	MN	MO	N	NI	P	S	SI	Cu	V	W
65Mn	52-56	0.6-0.71		0.8-1.1				0.04	0.05				
1070	54-56	0.65-0.75		0.6-0.9				0.03	0.05				
1095	57-59	0.9-1.03		0.3-0.5				0.03	0.05				
4034	56-58	0.42-0.5	12.5-14.5	1									
4116	55-57	0.45-0.55	14-15		0.5-0.8							0.1-0.2	
420J2	52-55	0.15-0.36	12-14	1			1	0.04	0.03	1			
440C		0.95-1.2	16-18	1	0.75			0.04	0.03	1			
2Cr13	51-53	0.15	12-14	1				0.04	0.03	1	0.09		
3Cr13	52-55	0.26-0.35	12-14	1			0.6	0.04	0.03	1			
7Cr17MoV	56-58	0.6-0.75	16-18	1	0.75		0.6	0.04	0.03	1		0.04	
8Cr13MoV	58-60	0.7-0.8	13-14.5	1	0.1-0.3		0.2	0.04	0.03	1		0.1-0.25	
9Cr14MoV	57-59	0.85-0.9	13.5-14	0.3-0.6	0.2-0.25			0.035	0.03	0.3-0.6		0.1-0.15	
9Cr18MoV	58-60	0.85-0.95	17-19	0.8	1-1.3		0.6	0.04	0.03	0.8		0.07-0.12	
AUS-8	58-59	0.7-0.75	13-14.5	0.5	0.1-0.3		0.49	0.04	0.03	1		0.1-0.26	
D2	57-61	1.5-1.6	11.5-12	0.15-0.45	0.6-0.9			0.03	0.03	0.1-0.4		0.9-1.1	
SK5	57-58	0.8-0.9	0.0-0.3	0.1-0.5			0.0-0.25	0.03	0.03	0.1-0.35	0.0-2.5		
S30V	59.5-61	1.45-1.46	14	0.5	2	0.1		0.03	0.03	.5		4	0.1-0.4

Various Benefits of Elements Used in Stainless Steels								
Element	Increases Corrosion Resistance	Increases Edge Retention	Increases Hardness	Increases Hardenability	Increases Tensile Strength	Increases Impact Strength	Increases Toughness	Increases Wear & Abrasion Resistance
Carbon		X	X		X			X
Chromium	X		X		X		X	X
Copper	X							
Manganese				X	X			X
Molybdenum			X	X	X		X	X
Nickel	X		X					
Nitrogen	X							
Phosphorus			X		X			
Silicon					X			
Tungsten						X	X	X
Vanadium			X		X	X		

Tough		All-Purpose			Edge Hold	
USA	420HC/425MOD		440A		440C/154CM	S30V
China	2Cr13/3Cr13/65Mn	5Cr15MoV/6Cr13	7Cr17MoV	8Cr13MoV	9Cr14MoV/9Cr18MoV	
Europe		4116				
Taiwan/Japan	420J2	AUS-6/4034		AUS-8	AUS-10/ATS34	
Hardness (HRC)	51-55	55-58	57-59	58-60	57-60	59-61



Saw Cut OT Handle



Staglon® Handle



Aluminum



TPE



TPR



Polyamides (PA)



Polypropylene (PP)



Carbon Fiber



G-10



Grivory

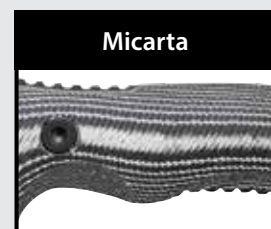

Micarta



Nylon Fiber



Stainless Steel

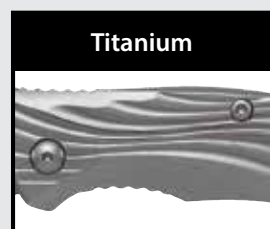

Titanium

Handle & Sheath Materials

Saw Cut OT Handle Scales: This lightweight and durable polymer was engineered for its excellent long-term wear characteristics.

Staglon® Handle Scales: This lightweight and durable polymer was engineered for its excellent long-term wear characteristics. Cosmetically designed to mimic Stag Horn.

Aluminum: Relatively soft, durable, lightweight, corrosion resistant, non-metallic metal. Aluminum has about one-third the density and stiffness of steel and is easily machined, cast, drawn and extruded.

TPE: This black thermoplastic elastomer is basically a softer version of TPR and offers a superb flexibility and memory elasticity even under harsh conditions. Most often molded onto a harder sub structure TPE material offers excellent grip and comfort.

TPR: This thermoplastic rubber is best described as a material which has both the characteristics of rubber as well as plastic. TPR rubber is usually light in weight, has good tear strength, flexible on low temperature, weather resistant, reusable and recyclable and it performs like vulcanized rubber.

PA: A plastic material Polyamides (PA) are semi-crystalline polymers. Polyamides have very good mechanical properties, are particularly tough, and have excellent sliding and wear characteristics. Properties vary from the hard and tough PA 66 to the soft and flexible PA 12. Depending on the type, polyamides absorb different amounts of moisture which also affect the mechanical characteristics.

PP: Polypropylene (PP) is a thermoplastic polymer used in a wide variety of applications. Commonly used in manufacturing processes such as injection molding.

Carbon Fiber: This material is a woven composite of graphite fibers fused together with an epoxy resin. The result is an ultra light weight handle with an extreme tensile strength. Most often seen with a visible weave-like pattern which can be varied as can the color of the epoxy used.

G-10: An epoxy filled woven "E" glass composite, reinforced with glass fibers for strength. Originally designed for circuit boards G-10 offers the knife industry a handle which is impervious to most elements such as oils, water, and acids. It can be produced in many colors, and finished in a variety of ways, offering different amounts of texture matched to different end users.

Grivory: Polyphthalamide is a thermoplastic synthetic resin that can be used to replace metals in high temperature applications. This material is suitable for other applications such as handle materials in knives and other cutting tools. Typical characteristics are high heat resistance, high chemical resistance, abrasion/corrosion resistance, high tensile strength, high dimensional stability, and direct bonding to many elastomers to give plastic-rubber composites.

Leather Sheaths: Our leather sheaths are made of 100% vegetable tanned top grain genuine cowhide. No finished split leather, bonded or imitation leather, nor any chrome tanned leather that can cause corrosion to the knife blades. The leather is "roller coated" for durability with a rich top coat finish. The tough, durable "roller coated" finish provides for protection from the outdoor elements, is more scratch resistant and has shown proven long-lasting wear. The sheaths are stitched with heavy duty nylon thread in order to provide high tensile strength, durability and long term wear. The 24 and 20 line durable and baby durable all metal snap fasteners are nickel-plated to prevent rust and corrosion. No plastic snaps are used. Many of the styles receive nickel-plated metal rivets in strategic locations to provide added strength, durability and safety.

Micarta: Technically described as "fabric reinforced phenolic laminate", micarta is created by pouring a resin into a flat pan, then laying down a strip of linen or paper fabric, which then is saturated with a resin. This process is repeated until the desired thickness is achieved. Micarta can be in many different colors, is lightweight, and can be finished in many ways.

Nylon Fiber: A synthetic thermoplastic polymer. Engineering grade nylon fiber is processed by extrusion, casting, and injection molding and is available in glass-filled variants which increases structural, impact strength and rigidity.

Stainless Steel: A steel alloy with a minimum of 10.5% chromium. Stainless steel does not readily corrode, rust, or stain with water as ordinary steel does, it is not stain proof but rather stains less.

Titanium: A chemical element with the symbol Ti. It is a lustrous transition metal with a silver color, low density, and high strength. Two of the most useful properties of the metal are corrosion resistance and the highest strength-to-weight ratio of any metal.

General Terms

Anodizing: An electro-chemical coating altering appearance and improving texture.

Black Oxide: A coating used mostly on military knives to avoid reflection.

Black or Grey Ti: A thin black or grey coating of titanium carbonitride, provides corrosion resistance.

Bolster: A piece of metal, generally nickel silver or stainless steel, that is located at one or both ends of a folding knife handle.

Button Lock: Found mainly on automatic knives, this type of lock uses a small push-button to open and release the blade.

Choil: A choil is a dip or cut out separating the cutting edge from the ricasso. It is also used to describe a cut out, molded or formed area where the handle and blade meet which positions/guards the index finger while gripping the opened knife.

Detent: A minute divot or dimple machined into the blade tang. A ball bearing drops into the detent hole when the knife is in the closed position, helping to hold the knife blade closed inside the handle.

Ergonomics: The applied science of equipment design intended to maximize productivity by reducing operator fatigue, safety, and discomfort. Knives which are designed to be comfortable and less fatiguing when used are labeled "ergonomic".

Finger Choil: A purposeful and specific area/curve cut out between the blade and handle. It creates a grip position point closer to the cutting edge for better control while cutting.

Frame Lock: Also known as the integral lock or monolock, this locking mechanism works in a manner similar to the liner lock but uses a partial cutout of the actual knife handle, rather than a separate liner inside the handle to hold the blade in place. To close you simply move the frame out of the way and rotate the blade into the closed position.

Handguard: Protrusion/expansion on the knife's handle proximal to the blade keeping the hand safely positioned on the handle inhibiting sliding forward.

Lanyard Hole: A small hole in a knife's handle for threading through a cord/string as a backup attachment when using the knife around water or where it may be dropped and lost.

Liner Lock: The liner lock's locking side liner is split from the top toward the bottom, similar to an automotive leaf spring (also called a lock bar) that when the blade is fully open will butt up against the tang of the blade to prevent the blade from closing. To release the lock, the user presses the lock bar back toward the handle side, at which time the blade is free to close. In the closed position the lock bar (leaf spring) rests alongside the handle and the blade.

Lockback: Also known as a spine lock, the lockback includes a pivoted latch affixed to a spring, and can be disengaged only by pressing the latch down to release the blade.

MOLLE: Modular Lightweight Load-carrying Equipment is the current system of loadbearing equipment based in the Pouch Attachment Ladder System (PALS) used by military and law enforcement. It consists of a grid of nylon webbing allowing the modular attachment of pouches and other equipment to achieve customized and mission-specific configurations.

Pommel: The knob or expansion found on the butt-end of a knife handle.

Quillion: A handguard protruding from both sides of the handle (where handle and blade meet) stopping the hand from slipping up onto the blade.

Ricasso: Unsharpened and thicker portion of the blade, just before the handle. Allows users to choke up on the blade for better control.

Scale: A knife handle made of scales or slabs of material that are riveted, screwed, or bonded together.

Skeletonized Liners: Internal steel handle liners that are hollowed out (skeletonized). In removing sections of the steel, bulk, and weight are reduced while allowing the liner to maintain its strength and rigidity.

Slip Joint: Non Locking Blade-a blade having a spring acting against it, which provides some resistance to its opening and closing as it pivots within the handle.

Spine Jimping: Small serrations, notching, or texturing located on the spine of a blade where the hand or finger grips. Jimping creates tactile resistance, adds purchase, traction, and slip resistance.

Swedge: Blade grind where a portion of the blade's spine is removed to reduce weight, add style to a blade or both.

Tang: The portion of the blade where it connects to the handle.

Tip-Up/Tip-Down: Refers to which direction the folded knife is positioned by its pocket clip. When closed and clipped in a pocket, whichever direction (up or down) the blade's tip sits defines if it is termed tip-up or tip-down.



Bolster



Button Lock

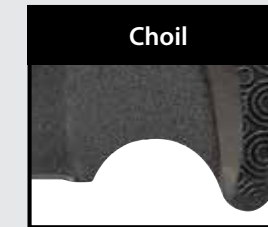

Choil

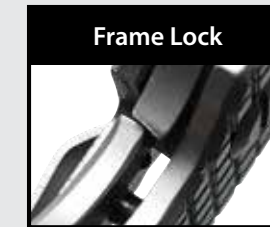

Frame Lock



Handguard



Liner Lock



Lockback

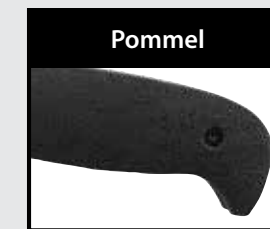

Pommel



Quillion



Ricasso

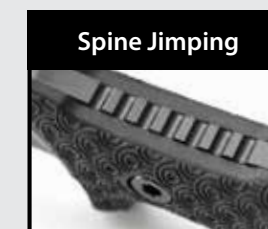

Spine Jimping

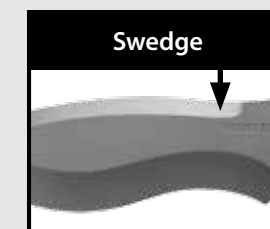

Swedge



Tang



Tip-Up/Tip-Down

Smith & Wesson®

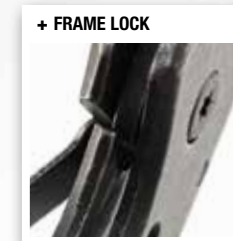
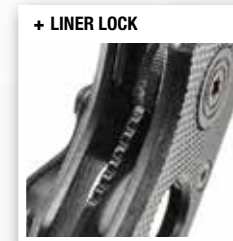



4034 Stainless Steel Blade Aluminum Handle

- + M.A.G.I.C. Assisted Opening
- + Finger Actuator
- + Thumb Plate
- + Liner Lock
- + Safety Lock
- + Glass Breaker
- + Pocket Clip



SWMP9B M&P® SMITH & WESSON®

Blade Length
3.5" (8.9 cm)
Overall Length
8.5" (21.6 cm)
Weight
7.8 oz.
UPC
028634706662

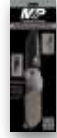

SWMP9BCP Clam Pack
UPC 028634706709



SWMP9BS M&P® SMITH & WESSON®

Blade Length
3.5" (8.9 cm)
Overall Length
8.5" (21.6 cm)
Weight
7.8 oz.
UPC
028634706679



SWMP9BT M&P® SMITH & WESSON®

Blade Length
3.5" (8.9 cm)
Overall Length
8.5" (21.6 cm)
Weight
7.8 oz.
UPC
028634706686



SWMP9BTS M&P® SMITH & WESSON®

Blade Length
3.5" (8.9 cm)
Overall Length
8.5" (21.6 cm)
Weight
7.8 oz.
UPC
028634706693



SWMP9BTSCP Clam Pack
UPC 028634706730



4034 Stainless Steel Blade Aluminum Handle

- + M.A.G.I.C. Assisted Opening
- + Finger Actuator
- + Thumb Plate
- + Liner Lock
- + Safety Lock
- + Glass Breaker
- + Pocket Clip



SWMP4LBS M&P® SMITH & WESSON®

Blade Length
3.6" (9.1 cm)
Overall Length
8.6" (21.8 cm)
Weight
7.6 oz.
UPC
028634702589



SWMP4L M&P® SMITH & WESSON®

Blade Length
3.6" (9.1 cm)
Overall Length
8.6" (21.8 cm)
Weight
7.6 oz.
UPC
028634702558



SWMP4LS M&P® SMITH & WESSON®

Blade Length
3.6" (9.1 cm)
Overall Length
8.6" (21.8 cm)
Weight
7.6 oz.
UPC
028634702565



SWMP4LSCP Clam Pack
UPC 028634703678





**4034 Stainless Steel Blade
Aluminum Handle**

- + M.A.G.I.C. Assisted Opening
- + Finger Actuator
- + Dual Thumb Knobs
- + Liner Lock
- + Safety Lock
- + Pocket Clip



SWMP6 M&P® SMITH & WESSON®

Blade Length
3.4" (8.6 cm)
Overall Length
7.7" (19.6 cm)
Weight
5.5 oz.
UPC
028634704798



SWMP6CP Clam Pack
UPC 028634704859



SWMP6S M&P® SMITH & WESSON®

Blade Length
3.4" (8.6 cm)
Overall Length
7.7" (19.6 cm)
Weight
5.5 oz.
UPC
028634704804



SWMP6B M&P® SMITH & WESSON®

Blade Length
3.4" (8.6 cm)
Overall Length
7.7" (19.6 cm)
Weight
5.5 oz.
UPC
028634704811



SWMP6BS M&P® SMITH & WESSON®

Blade Length
3.4" (8.6 cm)
Overall Length
7.7" (19.6 cm)
Weight
5.5 oz.
UPC
028634704828



SWMP6CN M&P® SMITH & WESSON®

Blade Length
3.4" (8.6 cm)
Overall Length
7.7" (19.6 cm)
Weight
5.5 oz.
UPC
028634705009



SWMP6CNCP Clam Pack
UPC 028634705023



SWMP6CNS M&P® SMITH & WESSON®

Blade Length
3.4" (8.6 cm)
Overall Length
7.7" (19.6 cm)
Weight
5.5 oz.
UPC
028634705016



SWMP6CNSCP Clam Pack
UPC 028634705030



4034 Stainless Steel Blade Aluminum Handle

- + M.A.G.I.C. Assisted Opening
- + Finger Actuator
- + Dual Thumb Knobs
- + Liner Lock
- + Safety Lock
- + Glass Breaker
- + Pocket Clip



SWMP1 M&P® SMITH & WESSON®

Blade Length
2.9" (7.4 cm)
Overall Length
7.1" (18.0 cm)
Weight
4.1 oz.
UPC
028634701001



SWMP1B M&P® SMITH & WESSON®

Blade Length
2.9" (7.4 cm)
Overall Length
7.1" (18.0 cm)
Weight
4.1 oz.
UPC
028634701063



SWMP1BCP Clam Pack
UPC 028634703708



SWMP1BS M&P® SMITH & WESSON®

Blade Length
2.9" (7.4 cm)
Overall Length
7.1" (18.0 cm)
Weight
4.1 oz.
UPC
028634701070



SWMP1BSCP Clam Pack
UPC 028634703142



SWMP1BSD M&P® SMITH & WESSON®

4034 Stainless Steel Blade Aluminum Handle

- + M.A.G.I.C. Assisted Opening
- + Finger Actuator
- + Dual Thumb Knobs
- + Liner Lock
- + Safety Lock
- + Glass Breaker
- + Pocket Clip

Blade Length
2.9" (7.4 cm)
Overall Length
7.1" (18.0 cm)
Weight
4.1 oz.
UPC
028634701483



SWMP2BS M&P® SMITH & WESSON®

4034 Stainless Steel Blade Aluminum Handle

- + M.A.G.I.C. Assisted Opening
- + Finger Actuator
- + Dual Thumb Knobs
- + Liner Lock
- + Safety Lock
- + Glass Breaker
- + Pocket Clip

Blade Length
2.8" (7.1 cm)
Overall Length
7.0" (17.8 cm)
Weight
4.1 oz.
UPC
028634701094



4034 Stainless Steel Blade Aluminum Handle

- + M.A.G.I.C. Assisted Opening
- + Finger Actuator
- + Dual Thumb Knobs
- + Liner Lock
- + Safety Lock
- + Glass Breaker
- + Pocket Clip



SWMP3BSD M&P® SMITH & WESSON®

Blade Length
2.8" (7.1 cm)
Overall Length
7.1" (18.0 cm)
Weight
4.1 oz.
UPC
028634701520

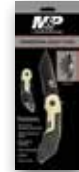

SWMP3BSDCP Clam Pack
UPC 028634703609



SWMP3B M&P® SMITH & WESSON®

Blade Length
2.8" (7.1 cm)
Overall Length
7.1" (18.0 cm)
Weight
4.1 oz.
UPC
028634701100



SWMP3BS M&P® SMITH & WESSON®

Blade Length
2.8" (7.1 cm)
Overall Length
7.1" (18.0 cm)
Weight
4.1 oz.
UPC
028634701117



SWMP3BS SPC Clam Pack
UPC 028634703487



SWMP5L M&P® SMITH & WESSON®

4034 Stainless Steel Blade Aluminum Handle

- + M.A.G.I.C. Assisted Opening
- + Finger Actuator
- + Thumb Plate
- + Liner Lock
- + Safety Lock
- + Glass Breaker
- + Pocket Clip

Blade Length
3.5" (8.9 cm)
Overall Length
8.5" (21.6 cm)
Weight
7.2 oz.
UPC
028634702732



SWMP5L LCP Clam Pack
UPC 028634703685



SWMP5LS M&P® SMITH & WESSON®

4034 Stainless Steel Blade Aluminum Handle

- + M.A.G.I.C. Assisted Opening
- + Finger Actuator
- + Thumb Plate
- + Liner Lock
- + Safety Lock
- + Glass Breaker
- + Pocket Clip

Blade Length
3.5" (8.9 cm)
Overall Length
8.5" (21.6 cm)
Weight
7.2 oz.
UPC
028634702749



SWMP10 M&P® SMITH & WESSON®

**7Cr17MoV High Carbon Stainless Steel Blade
Aluminum Handle**

- + Dual Thumb Knobs
- + Liner Lock
- + Index Flipper
- + Strap Cutter
- + Ceramic Glass Breaker
- + Pocket Clip

Blade Length
3.9" (9.8 cm)
Overall Length
8.9" (22.6 cm)
Weight
5.2 oz.
UPC
028634708451



SWMP10CP Clam Pack
UPC 028634708482



SWMP11B M&P® SMITH & WESSON®

**7Cr17MoV High Carbon Stainless Steel Blade
Aluminum Handle**

- + Dual Thumb Knobs
- + Liner Lock
- + Strap Cutter
- + Ceramic Glass Breaker
- + Pocket Clip

Blade Length
3.8" (9.6 cm)
Overall Length
8.9" (22.7 cm)
Weight
5.7 oz.
UPC
028634708604



SWMP11BCP Clam Pack
UPC 028634708611



SWMP10G M&P® SMITH & WESSON®

**7Cr17MoV High Carbon Stainless Steel Blade
Aluminum Handle**

- + Dual Thumb Knobs
- + Liner Lock
- + Index Flipper
- + Strap Cutter
- + Ceramic Glass Breaker
- + Pocket Clip

Blade Length
3.9" (9.8 cm)
Overall Length
8.9" (22.6 cm)
Weight
5.2 oz.
UPC
028634708444



SWMP10GCP Clam Pack
UPC 028634708475

SWMP11G M&P® SMITH & WESSON®

**7Cr17MoV High Carbon Stainless Steel Blade
Aluminum Handle**

- + Dual Thumb Knobs
- + Liner Lock
- + Strap Cutter
- + Ceramic Glass Breaker
- + Pocket Clip

Blade Length
3.8" (9.6 cm)
Overall Length
8.9" (22.7 cm)
Weight
5.7 oz.
UPC
028634708895



SWMP11GCP Clam Pack
UPC 028634708901

SWMP7TS M&P® SMITH & WESSON®

9Cr18MoV High Carbon Steel Blade
Rubber Injected Aluminum Handle

- + Dual Thumb Knobs
- + Push Button Lock
- + Pocket Clip

Blade Length
3.1" (7.8 cm)
Overall Length
7.7" (19.5 cm)
Weight
3.2 oz.
UPC
028634706167



SWMP7TSCP Clam Pack
UPC 028634706129

SWMP8BS M&P® SMITH & WESSON®

9Cr18MoV High Carbon Steel Blade
Rubber Injected Aluminum Handle

- + Dual Thumb Knobs
- + Push Button Lock
- + Strap Cutter
- + Glass Breaker
- + Pocket Clip

Blade Length
3.2" (8.1 cm)
Overall Length
7.8" (19.8 cm)
Weight
3.5 oz.
UPC
028634706150



SWMP8BSCP Clam Pack
UPC 028634706112

SWMP12S M&P® SMITH & WESSON®



8Cr13MoV High Carbon Stainless Steel Blade
Aluminum w/Rubber Handle

- + Dual Thumb Knobs
- + Liner Lock
- + Index Flipper
- + Pocket Clip

Blade Length
3.5" (8.8 cm)
Overall Length
8.3" (21.0 cm)
Weight
5.1 oz.
UPC
028634709298



SWMP12BLS M&P® SMITH & WESSON®



8Cr13MoV High Carbon Stainless Steel Blade
Aluminum w/Rubber Handle

- + Dual Thumb Knobs
- + Liner Lock
- + Index Flipper
- + Pocket Clip

Blade Length
3.5" (8.8 cm)
Overall Length
8.3" (21.0 cm)
Weight
5.1 oz.
UPC
028634709311



8Cr13MoV High Carbon S.S. Blade Aluminum Handle

- + Dual Thumb Knobs
- + Liner Lock

- + Index Flipper
- + Pocket Clip



SWMP13BS M&P® SMITH & WESSON®

NEW

Blade Length
3.5" (8.8 cm)
Overall Length
8.2" (20.9 cm)
Weight
4.9 oz.
UPC
028634709250



SWMP13BSCP Clam Pack
UPC 028634709267



SWMP13GS M&P® SMITH & WESSON®

NEW

Blade Length
3.5" (8.8 cm)
Overall Length
8.2" (20.9 cm)
Weight
4.9 oz.
UPC
028634709236



SWMP13GSCP Clam Pack
UPC 028634709243



SWMP13GLS M&P® SMITH & WESSON®

NEW

Blade Length
3.5" (8.8 cm)
Overall Length
8.2" (20.9 cm)
Weight
4.9 oz.
UPC
028634709274



SWMP13GLSCP Clam Pack
UPC 028634709281



SWMPF2BS M&P® SMITH & WESSON®

NEW

8Cr13MoV High Carbon S.S. Blade Aluminum w/Rubber Handle

- + Full Tang
- + M.O.L.L.E. Compatible Thermoplastic Belt Sheath

Blade Length
4.1" (10.3 cm)
Overall Length
8.7" (22.1 cm)
Weight
6.6 oz.
UPC
028634709502



SWMPF2BSCP Clam Pack
UPC 028634709519



SWMPF3BR M&P® SMITH & WESSON®

NEW

8Cr13MoV High Carbon S.S. Blade Rubberized Handle

- + Full Tang
- + Thermoplastic Belt/Boot Sheath

Blade Length
4.6" (11.6 cm)
Overall Length
9.0" (22.9 cm)
Weight
3.5 oz.
UPC
028634709540



SWMPF3BRCP Clam Pack
UPC 028634709526



SWMPF3G M&P® SMITH & WESSON®

NEW

8Cr13MoV High Carbon S.S. Blade Rubberized Handle

- + Full Tang
- + Thermoplastic Belt/Boot Sheath

Blade Length
4.6" (11.6 cm)
Overall Length
9.0" (22.9 cm)
Weight
3.5 oz.
UPC
028634709557



SWMPF3GCP Clam Pack
UPC 028634709533





**AUS-8 Steel Blade
Aluminum Handle**

- + Blade Release
- + Safety Lock
- + Glass Breaker
- + Blade Slider
- + Pocket Clip



BLADE SLIDER



Out The Front Assisted Opening

SWOTF9B SMITH & WESSON® OUT THE FRONT

NEW

Blade Length
3.6" (9.1 cm)
Overall Length
8.8" (22.3 cm)
Weight
6.0 oz.
UPC
028634709762
No Ship CA, NY, MA



SWOTF9TB SMITH & WESSON® OUT THE FRONT

NEW

Blade Length
3.6" (9.1 cm)
Overall Length
8.8" (22.3 cm)
Weight
6.0 oz.
UPC
028634709786



SWOTF9BS SMITH & WESSON® OUT THE FRONT

NEW

Blade Length
3.6" (9.1 cm)
Overall Length
8.8" (22.3 cm)
Weight
6.0 oz.
UPC
028634709779
No Ship CA, NY, MA



SWOTF9TBS SMITH & WESSON® OUT THE FRONT

NEW

Blade Length
3.6" (9.1 cm)
Overall Length
8.8" (22.3 cm)
Weight
6.0 oz.
UPC
028634709793



4034 Stainless Steel Blade Aluminum Handle

- + M.A.G.I.C. Assisted Opening
- + Finger Actuator
- + Dual Thumb Knobs
- + Liner Lock
- + Safety Lock
- + Pocket Clip



SWBLOP3 SMITH & WESSON® BLACK OPS®

Blade Length
3.4" (8.6 cm)
Overall Length
7.7" (19.5 cm)
Weight
4.8 oz.
UPC
028634703524



SWBLOP3CP Clam Pack
UPC 028634704316



SWBLOP3S SMITH & WESSON® BLACK OPS®

Blade Length
3.4" (8.6 cm)
Overall Length
7.7" (19.5 cm)
Weight
4.8 oz.
UPC
028634703531



SWBLOP3SCP Clam Pack
UPC 028634704354



SWBLOP3T SMITH & WESSON® BLACK OPS®

Blade Length
3.4" (8.6 cm)
Overall Length
7.7" (19.5 cm)
Weight
4.8 oz.
UPC
028634703548



SWBLOP3TS SMITH & WESSON® BLACK OPS®

Blade Length
3.4" (8.6 cm)
Overall Length
7.7" (19.5 cm)
Weight
4.8 oz.
UPC
028634703555



SWBLOP3TSCP Clam Pack
UPC 028634704446



SWBLOP3TD

SMITH & WESSON® BLACK OPS®

Blade Length
3.4" (8.6 cm)
Overall Length
7.7" (19.5 cm)
Weight
4.8 oz.
UPC
028634706372



SWBLOP3TBL/SWBLOP3TBLS

SMITH & WESSON® BLACK OPS®

Blade Length
3.4" (8.6 cm)
Overall Length
7.7" (19.5 cm)
Weight
4.8 oz.

+ SWBLOP3TBL

SWBLOP3TBL UPC
028634704040

+ SWBLOP3TBLS

SWBLOP3TBLS UPC
028634704057



SWBLOP3R/SWBLOP3RS

SMITH & WESSON® BLACK OPS®

Blade Length
3.4" (8.6 cm)
Overall Length
7.7" (19.5 cm)
Weight
4.8 oz.

+ SWBLOP3R

SWBLOP3R UPC
028634704026

+ SWBLOP3RS

SWBLOP3RS UPC
028634704033





4034 Stainless Steel Blade Aluminum Handle

- + M.A.G.I.C. Assisted Opening
- + Finger Actuator
- + Dual Thumb Knobs
- + Liner Lock
- + Safety Lock
- + Pocket Clip

SWBLOP3SMP SMITH & WESSON® BLACK OPS®

Blade Length
2.5" (6.3cm)
Overall Length
5.8" (14.7 cm)
Weight
2.6 oz.
UPC
028634705993



SWBLOP3SMPCP Clam Pack
UPC 028634705795



SWBLOP3SMS SMITH & WESSON® BLACK OPS®

Blade Length
2.5" (6.3cm)
Overall Length
5.8" (14.7 cm)
Weight
2.6 oz.
UPC
028634705641



SWBLOP3SMSCP Clam Pack
UPC 028634705702



SWBLOP3SMT SMITH & WESSON® BLACK OPS®

Blade Length
2.5" (6.3cm)
Overall Length
5.8" (14.7 cm)
Weight
2.6 oz.
UPC
028634705658



4034 Stainless Steel Blade Aluminum Handle

- + M.A.G.I.C. Assisted Opening
- + Finger Actuator
- + Dual Thumb Knobs
- + Liner Lock
- + Safety Lock
- + Pocket Clip



SWBLOP2SMTB SMITH & WESSON® BLACK OPS®

Blade Length
2.6" (6.6 cm)
Overall Length
5.9" (15.0 cm)
Weight
2.3 oz.
UPC
028634705610



SWBLOP2SMTBCP Clam Pack
UPC 028634705672



SWBLOP2SMB5 SMITH & WESSON® BLACK OPS®

Blade Length
2.6" (6.6 cm)
Overall Length
5.9" (15.0 cm)
Weight
2.3 oz.
UPC
028634705603



SWBLOP2SMB5CP Clam Pack
UPC 028634705665



SWBLOP2B SMITH & WESSON® BLACK OPS®

Blade Length
3.4" (8.6 cm)
Overall Length
7.7" (19.5 cm)
Weight
4.2 oz.
UPC
028634702398



SWBLOP2BS SMITH & WESSON® BLACK OPS®

Blade Length
3.4" (8.6 cm)
Overall Length
7.7" (19.5 cm)
Weight
4.2 oz.
UPC
028634702404



SWBLOP2BSCP Clam Pack
UPC 028634702909





**4034 Stainless Steel Blade
Aluminum Handle**

- + M.A.G.I.C. Assisted Opening
- + Finger Actuator
- + Dual Thumb Knobs
- + Liner Lock
- + Safety Lock
- + Reversible Pocket Clip

SWBLOP4 SMITH & WESSON® BLACK OPS®

Blade Length
3.3" (8.4 cm)
Overall Length
7.7" (19.5 cm)
Weight
4.9 oz.
UPC
028634704934



SWBLOP4BS SMITH & WESSON® BLACK OPS®

Blade Length
3.3" (8.4 cm)
Overall Length
7.7" (19.5 cm)
Weight
4.9 oz.
UPC
028634704965



SPECM SMITH & WESSON® SPECIAL OPS®

Blade Length
3.1" (7.9 cm)
Overall Length
7.4" (18.8 cm)
Weight
4.1 oz.
UPC
028634701322



SPECMS SMITH & WESSON® SPECIAL OPS®

Blade Length
3.1" (7.9 cm)
Overall Length
7.4" (18.8 cm)
Weight
4.1 oz.
UPC
028634701339



BSPECL SMITH & WESSON® SPECIAL OPS®

Blade Length
3.7" (9.4 cm)
Overall Length
8.5" (21.6 cm)
Weight
6.0 oz.
UPC
028634701360



BSPECLCP Clam Pack
UPC 028634704323

4034 Stainless Steel Blade Aluminum Handle

- + M.A.G.I.C. Assisted Opening
- + Finger Actuator
- + Dual Thumb Knobs
- + Liner Lock
- + Safety Lock
- + Pocket Clip



BSPECLS SMITH & WESSON® SPECIAL OPS®

Blade Length
3.7" (9.4 cm)
Overall Length
8.5" (21.6 cm)
Weight
6.0 oz.
UPC
028634701377



BSPECLS SPC Clam Pack
UPC 028634704330



SW6000MB SMITH & WESSON® ASSISTED OPENING

Blade Length
2.4" (6.1 cm)
Overall Length
5.6" (14.3 cm)
Weight
1.9 oz.
UPC
028634707904



SW6000MBCP Clam Pack
UPC 028634708635



4034 Stainless Steel Blade Aluminum Handle

- + M.A.G.I.C. Assisted Opening
- + Finger Actuator
- + Dual Thumb Knobs
- + Liner Lock
- + Safety Lock
- + Pocket Clip

SW6000MS SMITH & WESSON® ASSISTED OPENING

Blade Length
2.4" (6.1 cm)
Overall Length
5.6" (14.3 cm)
Weight
1.9 oz.
UPC
028634707911



SWATMB SMITH & WESSON® S.W.A.T.®

Blade Length
3.2" (8.2 cm)
Overall Length
7.5" (19.0 cm)
Weight
3.9 oz.
UPC
028634700165



SWATMBBCP Clam Pack
UPC 028634703722



4034 Stainless Steel Blade Aluminum Handle

- + M.A.G.I.C. Assisted Opening
- + Finger Actuator
- + Dual Thumb Knobs
- + Liner Lock
- + Safety Lock
- + Pocket Clip

SWATMBS SMITH & WESSON® S.W.A.T.®

Blade Length
3.2" (8.2 cm)
Overall Length
7.5" (19.0 cm)
Weight
3.9 oz.
UPC
028634700172



SW6000B SMITH & WESSON® ASSISTED OPENING

Blade Length
3.3" (8.4 cm)
Overall Length
7.7" (19.6 cm)
Weight
3.7 oz.
UPC
028634707348



SW6000BCP Clam Pack
UPC 028634707355



SWATLB SMITH & WESSON® S.W.A.T.®

Blade Length
3.7" (9.4 cm)
Overall Length
8.5" (21.7 cm)
Weight
5.8 oz.
UPC
028634700714



SW6000BS SMITH & WESSON® ASSISTED OPENING

Blade Length
3.3" (8.4 cm)
Overall Length
7.7" (19.6 cm)
Weight
3.7 oz.
UPC
028634707362



SW6000BSCP Clam Pack
UPC 028634707379



SWATLBS SMITH & WESSON® S.W.A.T.®

Blade Length
3.7" (9.4 cm)
Overall Length
8.5" (21.7 cm)
Weight
5.8 oz.
UPC
028634700721



SWATS SMITH & WESSON® S.W.A.T.®

4034 Stainless Steel Blade Aluminum Handle

- + M.A.G.I.C. Assisted Opening
- + Finger Actuator
- + Dual Thumb Knobs
- + Liner Lock
- + Safety Lock
- + Pocket Clip

Blade Length
2.5" (6.3 cm)
Overall Length
5.8" (14.7 cm)
Weight
2.3 oz.
UPC
028634700745



SWATSCP Clam Pack
UPC 028634703807



SWATB SMITH & WESSON® S.W.A.T.®

4034 Stainless Steel Blade Aluminum Handle

- + M.A.G.I.C. Assisted Opening
- + Finger Actuator
- + Dual Thumb Knobs
- + Liner Lock
- + Safety Lock
- + Pocket Clip

Blade Length
2.5" (6.3 cm)
Overall Length
5.8" (14.7 cm)
Weight
2.3 oz.
UPC
028634700752



SWATBCP Clam Pack
UPC 028634703470



SWATBS SMITH & WESSON® S.W.A.T.®

4034 Stainless Steel Blade Aluminum Handle

- + M.A.G.I.C. Assisted Opening
- + Finger Actuator
- + Dual Thumb Knobs
- + Liner Lock
- + Safety Lock
- + Pocket Clip

Blade Length
2.5" (6.3 cm)
Overall Length
5.8" (14.7 cm)
Weight
2.3 oz.
UPC
028634700769



4034 Stainless Steel Blade Nylon Fiber Handle

- + M.A.G.I.C. Assisted Opening
- + Finger Actuator
- + Dual Thumb Knobs
- + Liner Lock
- + Safety Lock
- + Spring Loaded Glass Punch
- + Pocket Clip



SW911B SMITH & WESSON® 1ST RESPONSE®

Blade Length
3.4" (8.6 cm)
Overall Length
8.2" (20.8 cm)
Weight
4.9 oz.
UPC
028634702176



Spring Loaded Glass Punch



Re-Curve Tanto Blade

SW911N SMITH & WESSON® 1ST RESPONSE®

Blade Length
3.4" (8.6 cm)
Overall Length
8.2" (20.8 cm)
Weight
4.9 oz.
UPC
028634702077



Spring Loaded Glass Punch



Blunt Tip Blade

Strap Cutter

SWFR SMITH & WESSON® 1ST RESPONSE®

**7Cr17MoV High Carbon Stainless Steel Blade
Stainless Steel w/G-10 Inlay Handle**

- + Thumb Plate
- + Liner Lock
- + Strap Cutter
- + Glass Breaker
- + Pocket Clip

Blade Length
3.3" (8.4 cm)
Overall Length
8.0" (20.3 cm)
Weight
5.8 oz.
UPC
028634700677



SW608S SMITH & WESSON® FOLDING KNIFE

NEW

**8Cr13MoV High Carbon S.S. Blade
Aluminum Handle**

- + Liner Lock
- + Index Flipper
- + Strap Cutter
- + Glass Breaker
- + Pocket Clip

Blade Length
3.4" (8.7 cm)
Overall Length
8.5" (21.5 cm)
Weight
4.3 oz.
UPC
028634709175



SWFRS SMITH & WESSON® 1ST RESPONSE®

**7Cr17MoV High Carbon Stainless Steel Blade
Stainless Steel w/G-10 Inlay Handle**

- + Thumb Plate
- + Liner Lock
- + Strap Cutter
- + Glass Breaker
- + Pocket Clip

Blade Length
3.3" (8.4 cm)
Overall Length
8.0" (20.3 cm)
Weight
5.8 oz.
UPC
028634700684



SWFRSCP Clam Pack
UPC 028634701391

SW608BLS SMITH & WESSON® FOLDING KNIFE

NEW

**8Cr13MoV High Carbon S.S. Blade
Aluminum Handle**

- + Liner Lock
- + Index Flipper
- + Strap Cutter
- + Glass Breaker
- + Pocket Clip

Blade Length
3.4" (8.7 cm)
Overall Length
8.5" (21.5 cm)
Weight
4.3 oz.
UPC
028634709199



SWFR2S SMITH & WESSON® EXTREME OPS®

**7Cr17MoV High Carbon Stainless Steel Blade
Special Coated Aluminum Handle**

- + Dual Thumb Knobs
- + Liner Lock
- + Strap Cutter
- + Glass Breaker
- + Pocket Clip

Blade Length
3.3" (8.4 cm)
Overall Length
8.0" (20.3 cm)
Weight
4.4 oz.
UPC
028634701605



SWFR2SCP Clam Pack
UPC 028634706174

SW608ORS SMITH & WESSON® FOLDING KNIFE

NEW

**8Cr13MoV High Carbon S.S. Blade
Aluminum Handle**

- + Liner Lock
- + Index Flipper
- + Strap Cutter
- + Glass Breaker
- + Pocket Clip

Blade Length
3.4" (8.7 cm)
Overall Length
8.5" (21.5 cm)
Weight
4.3 oz.
UPC
028634709397



**8Cr13MoV High Carbon S.S. Blade
Aluminum Handle**

- + Dual Thumb Knobs
- + Liner Lock
- + Index Flipper
- + Pocket Clip



SW605 SMITH & WESSON® FOLDING KNIFE

NEW

Blade Length
3.5" (8.8 cm)
Overall Length
8.2" (20.9 cm)
Weight
4.9 oz.
UPC
028634709076



SW605BL SMITH & WESSON® FOLDING KNIFE

NEW

Blade Length
3.5" (8.8 cm)
Overall Length
8.2" (20.9 cm)
Weight
4.9 oz.
UPC
028634709090



SW607S SMITH & WESSON® FOLDING KNIFE

NEW

8Cr13MoV High Carbon S.S. Blade Aluminum Handle

- + Dual Thumb Knobs
- + Liner Lock
- + Index Flipper
- + Pocket Clip

Blade Length
3.6" (9.0 cm)
Overall Length
8.4" (21.2 cm)
Weight
4.4 oz.
UPC
028634709151



SW607SCP Clam Pack
UPC 028634709168



SW609 SMITH & WESSON® FOLDING KNIFE

NEW

**Stone Washed 8Cr13MoV High Carbon S.S. Blade
Stone Washed S.S. w/G-10 Handle**

- + Dual Thumb Knobs
- + Frame Lock
- + Index Flipper
- + Pocket Clip

Blade Length
3.6" (9.0 cm)
Overall Length
8.3" (21.0 cm)
Weight
5.9 oz.
UPC
028634709212



SW609CP Clam Pack
UPC 028634709229



SW612S SMITH & WESSON® FOLDING KNIFE

NEW

8Cr13MoV High Carbon S.S. Blade TPE Handle

- + Dual Thumb Knobs
- + Liner Lock
- + Pocket Clip

Blade Length
3.6" (9.0 cm)
Overall Length
8.3" (21.0 cm)
Weight
5.3 oz.
UPC
028634709373



SW612SCP Clam Pack
UPC 028634709380



SW603 SMITH & WESSON® FOLDING KNIFE

NEW



**Stone Washed 8Cr13MoV High Carbon S.S. Blade
G-10 Handle**

- + Dual Thumb Knobs
- + Liner Lock
- + Index Flipper
- + Pocket Clip

Blade Length
3.8" (9.7 cm)
Overall Length
8.8" (22.4 cm)
Weight
6.9 oz.
UPC
028634708994



Paracord Lanyard

SW604 SMITH & WESSON® FOLDING KNIFE

NEW

**8Cr13MoV High Carbon S.S. Blade
G-10 Handle**

- + Dual Thumb Knobs
- + Liner Lock
- + Index Flipper
- + Pocket Clip

Blade Length
3.5" (8.9 cm)
Overall Length
8.5" (21.5 cm)
Weight
6.8 oz.
UPC
028634709014



Paracord Lanyard

SWBG9BS SMITH & WESSON® BORDER GUARD®

**Stone Washed 7Cr17MoV High Carbon S.S. Blade
G-10 Handle**

- + Dual Thumb Knobs
- + Liner Lock
- + Pocket Clip

Blade Length
3.4" (8.6 cm)
Overall Length
7.9" (20.2 cm)
Weight
4.5 oz.
UPC
028634708536



SWBG9BLS SMITH & WESSON® BORDER GUARD®

**Stone Washed 7Cr17MoV High Carbon S.S. Blade
G-10 Handle**

- + Dual Thumb Knobs
- + Liner Lock
- + Pocket Clip

Blade Length
3.4" (8.6 cm)
Overall Length
7.9" (20.2 cm)
Weight
4.5 oz.
UPC
028634708543



SWBG10S SMITH & WESSON® BORDER GUARD®

**Stone Washed 7Cr17MoV High Carbon S.S. Blade
Stone Washed Aluminum G-10 Insert Handle**

- + Dual Thumb Knobs
- + Liner Lock
- + Index Flipper
- + Strap Cutter
- + Glass Breaker
- + Pocket Clip

Blade Length
3.5" (8.9 cm)
Overall Length
8.3" (21.0 cm)
Weight
6.0 oz.
UPC
028634708550



SWBG10SCP Clam Pack
UPC 028634708888



**7Cr17MoV High Carbon Stainless Steel Blade
Aluminum Handle**

- + Dual Thumb Knobs
- + Liner Lock
- + Strap Cutter
- + Glass Breaker
- + Pocket Clip

SWBG1 SMITH & WESSON® BORDER GUARD®

Blade Length
4.4" (11.2 cm)
Overall Length
10.0" (25.4 cm)
Weight
8.8 oz.
UPC
028634702435



SWBG1S SMITH & WESSON® BORDER GUARD®

Blade Length
4.4" (11.2 cm)
Overall Length
10.0" (25.4 cm)
Weight
8.8 oz.
UPC
028634702442



SWBG2T SMITH & WESSON® BORDER GUARD®

Blade Length
4.4" (11.2 cm)
Overall Length
10.0" (25.4 cm)
Weight
8.8 oz.
UPC
028634702459



SWBG2TS SMITH & WESSON® BORDER GUARD®

Blade Length
4.4" (11.2 cm)
Overall Length
10.0" (25.4 cm)
Weight
8.8 oz.
UPC
028634702466



7Cr17MoV High Carbon S.S. Blade Aluminum Handle

- + Dual Thumb Knobs
- + Liner Lock
- + Strap Cutter
- + Glass Breaker
- + Pocket Clip

SWBG6TS SMITH & WESSON® BORDER GUARD®

Blade Length
4.2" (10.6 cm)
Overall Length
10.1" (25.6 cm)
Weight
9.2 oz.
UPC
028634706266

7Cr17MoV High Carbon S.S. Blade G-10 Handle

- + Dual Thumb Knobs
- + Liner Lock
- + Strap Cutter
- + Glass Breaker
- + Pocket Clip



**7Cr17MoV High Carbon Stainless Steel Blade
Stainless Steel Handle**

- + Dual Thumb Knobs
- + Liner Lock
- + Strap Cutter
- + Ceramic Glass Breaker
- + Pocket Clip



SWBG7 SMITH & WESSON® BORDER GUARD®

Blade Length
4.3" (11.0 cm)
Overall Length
10.2" (25.8 cm)
Weight
11.6 oz.
UPC
028634707584



SWBG7S SMITH & WESSON® BORDER GUARD®

Blade Length
4.3" (11.0 cm)
Overall Length
10.2" (25.8 cm)
Weight
11.6 oz.
UPC
028634707591



**7Cr17MoV High Carbon Stainless Steel Blade
Stainless Steel Handle**

- + Dual Thumb Knobs
- + Liner Lock
- + Strap Cutter
- + Pocket Clip



SWBG8T SMITH & WESSON® BORDER GUARD®

Blade Length
4.3" (11.0 cm)
Overall Length
10.0" (25.4 cm)
Weight
9.0 oz.
UPC
028634707607



SWBG8TS SMITH & WESSON® BORDER GUARD®

Blade Length
4.3" (11.0 cm)
Overall Length
10.0" (25.4 cm)
Weight
9.0 oz.
UPC
028634707614



**7Cr17MoV High Carbon Stainless Steel Blade
Aluminum Handle**

- + Push Button Lock
- + Safety Lock
- + Pocket Clip



SW40BS SMITH & WESSON® EXTREME OPS®

Blade Length
2.6" (6.7 cm)
Overall Length
6.3" (15.9 cm)
Weight
2.5 oz.
UPC
028634992249



SW40BTS SMITH & WESSON® EXTREME OPS®

Blade Length
2.6" (6.7 cm)
Overall Length
6.3" (15.9 cm)
Weight
2.5 oz.
UPC
028634992287



**7Cr17MoV High Carbon Stainless Steel Blade
Aluminum Handle**

- + Push Button Lock
- + Safety Lock
- + Pocket Clip



SW50B SMITH & WESSON® EXTREME OPS®

Blade Length
3.3" (8.3 cm)
Overall Length
7.8" (19.8 cm)
Weight
4.5 oz.
UPC
028634500017



SW50BS SMITH & WESSON® EXTREME OPS®

Blade Length
3.3" (8.3 cm)
Overall Length
7.8" (19.8 cm)
Weight
4.5 oz.
UPC
028634500024



SW50BT SMITH & WESSON® EXTREME OPS®

Blade Length
3.3" (8.3 cm)
Overall Length
7.8" (19.8 cm)
Weight
4.5 oz.
UPC
028634500031



SW50BTS SMITH & WESSON® EXTREME OPS®

Blade Length
3.3" (8.3 cm)
Overall Length
7.8" (19.8 cm)
Weight
4.5 oz.
UPC
028634500048



SW601 SMITH & WESSON® FOLDING KNIFE

**7Cr17MoV High Carbon Stainless Steel Blade
G-10 Handle**

- + Thumb Plate
- + Liner Lock
- + Pocket Clip

Blade Length
3.5" (9.0 cm)
Overall Length
8.8" (22.3 cm)
Weight
6.9 oz.
UPC
028634707461



CK13T SMITH & WESSON® EXTREME OPS®

**7Cr17MoV High Carbon Stainless Steel Blade
G-10 Handle**

- + Dual Thumb Knobs
- + Liner Lock
- + Pocket Clip

Blade Length
3.3" (8.4 cm)
Overall Length
7.8" (19.8 cm)
Weight
3.7 oz.
UPC
028634705320



CK13TCP Clam Pack
UPC 028634705115



SW601S SMITH & WESSON® FOLDING KNIFE

**7Cr17MoV High Carbon Stainless Steel Blade
G-10 Handle**

- + Thumb Plate
- + Liner Lock
- + Pocket Clip

Blade Length
3.5" (9.0 cm)
Overall Length
8.8" (22.3 cm)
Weight
6.9 oz.
UPC
028634707478



CK5TBSD SMITH & WESSON® EXTREME OPS®

**7Cr17MoV High Carbon Stainless Steel Blade
Aluminum Handle**

- + Dual Thumb Knobs
- + Liner Lock
- + Pocket Clip

Blade Length
3.2" (8.2 cm)
Overall Length
7.4" (18.7 cm)
Weight
2.9 oz.
UPC
028634000616



SW602 SMITH & WESSON® FOLDING KNIFE

**7Cr17MoV High Carbon Stainless Steel Blade
G-10 Handle**

- + Dual Thumb Knobs
- + Liner Lock
- + Pocket Clip

Blade Length
3.1" (8.0 cm)
Overall Length
7.6" (19.2 cm)
Weight
5.5 oz.
UPC
028634707485



CK5TBS SMITH & WESSON® EXTREME OPS®

**7Cr17MoV High Carbon Stainless Steel Blade
Aluminum Handle**

- + Dual Thumb Knobs
- + Liner Lock
- + Pocket Clip

Blade Length
3.2" (8.2 cm)
Overall Length
7.4" (18.7 cm)
Weight
2.9 oz.
UPC
028634105649



CK5TBS SCP Clam Pack
UPC 028634105656





CK105BK SMITH & WESSON® EXTREME OPS®

**7Cr17MoV High Carbon Stainless Steel Blade
Aluminum Handle**

- + Dual Thumb Knobs
- + Liner Lock
- + Pocket Clip

Blade Length
3.2" (8.2 cm)
Overall Length
7.3" (18.5 cm)
Weight
2.9 oz.
UPC
028634702503



CK105BKCP Clam Pack
UPC 028634704125



CK105BKEU SMITH & WESSON® EXTREME OPS®

**7Cr17MoV High Carbon Stainless Steel Blade
Aluminum Handle**

- + Nail Groove
- + Lockback
- + Pocket Clip

Blade Length
3.4" (8.6 cm)
Overall Length
8.0" (20.2 cm)
Weight
4.6 oz.
UPC
028634703401



CK105BL SMITH & WESSON® EXTREME OPS®

**7Cr17MoV High Carbon Stainless Steel Blade
Aluminum Handle**

- + Dual Thumb Knobs
- + Liner Lock
- + Pocket Clip

Blade Length
3.2" (8.2 cm)
Overall Length
7.3" (18.5 cm)
Weight
2.9 oz.
UPC
028634105632



CK105BLCP Clam Pack
UPC 028634105625



CK105HD SMITH & WESSON® EXTREME OPS®

**7Cr17MoV High Carbon Stainless Steel Blade
Aluminum Handle**

- + Dual Thumb Knobs
- + Liner Lock
- + Pocket Clip

Blade Length
3.2" (8.1 cm)
Overall Length
7.4" (18.7 cm)
Weight
2.9 oz.
UPC
028634000593



CK105HDCP Clam Pack
UPC 028634705122

CK105H SMITH & WESSON® EXTREME OPS®

**7Cr17MoV High Carbon Stainless Steel Blade
Aluminum Handle**

- + Dual Thumb Knobs
- + Liner Lock
- + Pocket Clip

Blade Length
3.2" (8.2 cm)
Overall Length
7.3" (18.5 cm)
Weight
2.9 oz.
UPC
028634105663



CK105HCP Clam Pack
UPC 028634105687





CK400 SMITH & WESSON® FOLDING KNIFE

**7Cr17MoV High Carbon Stainless Steel Blade
Stainless Steel Handle**

- + Dual Thumb Knobs
- + Frame Lock
- + Pocket Clip

Blade Length
2.2" (5.6 cm)
Overall Length
5.4" (13.6 cm)
Weight
1.6 oz.
UPC
028634707027



CK400CP Clam Pack
UPC 028634707164



CK401 SMITH & WESSON® FOLDING KNIFE

**7Cr17MoV High Carbon Stainless Steel Blade
Stainless Steel Handle**

- + Dual Thumb Knobs
- + Frame Lock
- + Pocket Clip

Blade Length
2.5" (6.3 cm)
Overall Length
5.9" (14.9 cm)
Weight
2.6 oz.
UPC
028634707034



CK401CP Clam Pack
UPC 028634707171



CK400L SMITH & WESSON® FOLDING KNIFE

**7Cr17MoV High Carbon Stainless Steel Blade
Stainless Steel Handle**

- + Dual Thumb Knobs
- + Frame Lock
- + Pocket Clip

Blade Length
3.0" (7.6 cm)
Overall Length
7.3" (18.5 cm)
Weight
3.4 oz.
UPC
028634707157



CK400LCP Clam Pack
UPC 028634707195



CK402 SMITH & WESSON® FOLDING KNIFE

**7Cr17MoV High Carbon Stainless Steel Blade
Aluminum Handle**

- + Dual Thumb Knobs
- + Liner Lock
- + Pocket Clip

Blade Length
2.8" (7.2 cm)
Overall Length
6.8" (17.2 cm)
Weight
3.4 oz.
UPC
028634707041



CK402CP Clam Pack
UPC 028634707188



CK400LTS SMITH & WESSON® FOLDING KNIFE

**7Cr17MoV High Carbon Stainless Steel Blade
Stainless Steel Handle**

- + Dual Thumb Knobs
- + Frame Lock
- + Pocket Clip

Blade Length
3.0" (7.6 cm)
Overall Length
7.3" (18.5 cm)
Weight
3.4 oz.
UPC
028634708116



CK400LTS SCP Clam Pack
UPC 028634708055



CK404 SMITH & WESSON® EXTREME OPS®

**Stone Washed 7Cr17MoV High Carbon S.S. Blade
Stone Washed Stainless Steel Handle**

- + Dual Thumb Knobs
- + Liner Lock
- + Pocket Clip

Blade Length
2.7" (6.7 cm)
Overall Length
6.2" (15.7 cm)
Weight
2.3 oz.
UPC
028634707409



CK404CP Clam Pack
UPC 028634707416



CK116 SMITH & WESSON® FOLDING KNIFE

**7Cr17MoV High Carbon Stainless Steel Blade
Stone Washed Aluminum Handle**

- + Dual Thumb Knobs
- + Liner Lock
- + Pocket Clip

Blade Length
3.1" (7.9 cm)
Overall Length
7.1" (18.0 cm)
Weight
4.2 oz.
UPC
028634708499



CK405 SMITH & WESSON® EXTREME OPS®

**Stone Washed 7Cr17MoV High Carbon S.S. Blade
G-10 & Stone Washed Aluminum Handle**

- + Dual Thumb Knobs
- + Liner Lock
- + Index Flipper
- + Strap Cutter
- + Pocket Clip

Blade Length
2.4" (6.0 cm)
Overall Length
5.8" (14.8 cm)
Weight
2.6 oz.
UPC
028634707423



CK405CP Clam Pack
UPC 028634707430



CK111 SMITH & WESSON® EXTREME OPS®

**7Cr17MoV High Carbon S.S. Blade
Aluminum Handle**

- + Dual Thumb Knobs
- + Liner Lock
- + Pocket Clip

Blade Length
3.1" (7.8 cm)
Overall Length
7.3" (18.5 cm)
Weight
2.8 oz.
UPC
028634700455



SW421 SMITH & WESSON® OASIS®

**7Cr17MoV High Carbon Stainless Steel Blade
Stainless Steel Handle**

- + Dual Thumb Knobs
- + Liner Lock
- + Pocket Clip

Blade Length
2.6" (6.7 cm)
Overall Length
6.2" (15.8 cm)
Weight
3.0 oz.
UPC
028634707447



SW421CP Clam Pack
UPC 028634707454



CK111S SMITH & WESSON® EXTREME OPS®

**7Cr17MoV High Carbon S.S. Blade
Aluminum Handle**

- + Dual Thumb Knobs
- + Liner Lock
- + Pocket Clip

Blade Length
3.1" (7.8 cm)
Overall Length
7.3" (18.5 cm)
Weight
2.8 oz.
UPC
028634700462



CK112 SMITH & WESSON® BULLSEYE®

Blade Length
3.4" (8.6 cm)
Overall Length
7.9" (20.1 cm)
Weight
4.2 oz.
UPC
028634702794

7Cr17MoV High Carbon S.S. Blade Aluminum Handle

- + Dual Thumb Knobs
- + Liner Lock
- + Pocket Clip



CK112S SMITH & WESSON® BULLSEYE®

Blade Length
3.4" (8.6 cm)
Overall Length
7.9" (20.1 cm)
Weight
4.2 oz.
UPC
028634702800



CK113 SMITH & WESSON® EXTREME OPS®

Blade Length
2.7" (6.8 cm)
Overall Length
6.4" (16.2 cm)
Weight
2.3 oz.
UPC
028634702831

7Cr17MoV High Carbon S.S. Blade Aluminum Handle

- + Dual Thumb Knobs
- + Liner Lock
- + Pocket Clip



CK113S SMITH & WESSON® EXTREME OPS®

Blade Length
2.7" (6.8 cm)
Overall Length
6.4" (16.2 cm)
Weight
2.3 oz.
UPC
028634702848



SWA24S SMITH & WESSON® EXTREME OPS®

7Cr17MoV Stainless Steel Blade Aluminum Handle

- + Dual Thumb Knobs
- + Liner Lock
- + Index Flipper
- + Pocket Clip

Blade Length
3.1" (7.9 cm)
Overall Length
7.1" (18.0 cm)
Weight
3.5 oz.
UPC
028634705436



SWA24SCP Clam Pack
UPC 028634704743



SWA25 SMITH & WESSON® EXTREME OPS®

7Cr17MoV High Carbon Stainless Steel Blade Aluminum Handle

- + Dual Thumb Knobs
- + Liner Lock
- + Pocket Clip

Blade Length
3.3" (8.4 cm)
Overall Length
7.8" (19.8 cm)
Weight
3.2 oz.
UPC
028634705443



SWA25CP Clam Pack
UPC 028634704750



CK204CP SMITH & WESSON® EXTREME OPS®

7Cr17MoV High Carbon Stainless Steel Blade Aluminum Handle

- + Dual Thumb Knobs
- + Liner Lock
- + Pocket Clip

Blade Length
3.1" (7.8 cm)
Overall Length
7.7" (19.5 cm)
Weight
4.0 oz.



CK204CP Clam Pack Only
UPC 028634708642





CK117B SMITH & WESSON® FOLDING KNIFE

**7Cr17MoV Stainless Steel Blade
Aluminum Handle**

- + Dual Thumb Knobs
- + Liner Lock
- + Pocket Clip

Blade Length
2.9" (7.4 cm)
Overall Length
7.1" (18.0 cm)
Weight
4.0 oz.
UPC
028634708819



CK117BCP Clam Pack
UPC 028634708826



CK117BR SMITH & WESSON® FOLDING KNIFE

**7Cr17MoV Stainless Steel Blade
Aluminum Handle**

- + Dual Thumb Knobs
- + Liner Lock
- + Pocket Clip

Blade Length
2.9" (7.4 cm)
Overall Length
7.1" (18.0 cm)
Weight
4.0 oz.
UPC
028634708512



CK117BRCP Clam Pack
UPC 028634708833



CK117SL SMITH & WESSON® FOLDING KNIFE

**7Cr17MoV Stainless Steel Blade
Aluminum Handle**

- + Dual Thumb Knobs
- + Liner Lock
- + Pocket Clip

Blade Length
2.9" (7.4 cm)
Overall Length
7.1" (18.0 cm)
Weight
4.0 oz.
UPC
028634708840



CK117SLCP Clam Pack
UPC 028634708857



CK10HBS SMITH & WESSON® EXTREME OPS®

**7Cr17MoV High Carbon Stainless Steel Blade
Stainless Steel Handle**

- + Dual Thumb Knobs
- + Frame Lock
- + Pocket Clip

Blade Length
3.4" (8.6 cm)
Overall Length
7.8" (19.8 cm)
Weight
3.9 oz.
UPC
028634700806



CK11HS SMITH & WESSON® EXTREME OPS®

**7Cr17MoV High Carbon Stainless Steel Blade
Stainless Steel Handle**

- + Dual Thumb Knobs
- + Frame Lock
- + Pocket Clip

Blade Length
3.4" (8.6 cm)
Overall Length
7.8" (19.8 cm)
Weight
4.8 oz.
UPC
028634700820





CK110B SMITH & WESSON® EXECUTIVE™

Titanium Coated 7Cr17MoV High Carbon S.S. Blade
Titanium Coated Stainless Steel Handle

- + Dual Thumb Knobs
- + Frame Lock
- + Pocket Clip

Blade Length
2.8" (7.1 cm)
 Overall Length
6.8" (17.3 cm)
 Weight
3.5 oz.
 UPC
028634700448



CK110GL SMITH & WESSON® EXECUTIVE™

Titanium Coated 7Cr17MoV High Carbon S.S. Blade
Titanium Coated Stainless Steel Handle

- + Dual Thumb Knobs
- + Frame Lock
- + Pocket Clip

Blade Length
2.8" (7.1 cm)
 Overall Length
6.8" (17.3 cm)
 Weight
3.5 oz.
 UPC
028634700431



Titanium Coated 7Cr17MoV High Carbon S.S. Blade
Titanium Coated S.S. Handle

- + Dual Thumb Knobs
- + Liner Lock
- + Pocket Clip



SW423G SMITH & WESSON® OASIS®

Blade Length
3.2" (8.1 cm)
 Overall Length
7.5" (19.1 cm)
 Weight
4.8 oz.
 UPC
028634700776



SW423GCP Clam Pack
 UPC 028634701407



SW423B SMITH & WESSON® OASIS®

Blade Length
3.2" (8.1 cm)
 Overall Length
7.5" (19.1 cm)
 Weight
4.8 oz.
 UPC
028634700783



SW423BS SMITH & WESSON® OASIS®

Blade Length
3.2" (8.1 cm)
 Overall Length
7.5" (19.1 cm)
 Weight
4.8 oz.
 UPC
028634701650



**7Cr17MoV High Carbon Stainless Steel Blade
ABS w/Rubber Coating Handle**

- + Dual Thumb Knobs
- + Liner Lock
- + Index Flipper
- + Pocket Clip



CKTAC SMITH & WESSON® SPECIAL TACTICAL®

Blade Length
3.5" (8.9 cm)
Overall Length
8.1" (20.6 cm)
Weight
3.5 oz.
UPC
028634000753



CKTACS SMITH & WESSON® SPECIAL TACTICAL®

Blade Length
3.5" (8.9 cm)
Overall Length
8.1" (20.6 cm)
Weight
3.5 oz.
UPC
028634000760



CKTACSD SMITH & WESSON® SPECIAL TACTICAL®

Blade Length
3.5" (8.9 cm)
Overall Length
8.1" (20.6 cm)
Weight
3.5 oz.
UPC
028634700233



CKTACSDCP Clam Pack
UPC 028634704477



**7Cr17MoV High Carbon Stainless Steel Blade
ABS w/Rubber Coating Handle**

- + Dual Thumb Knobs
- + Liner Lock
- + Index Flipper
- + Pocket Clip



CKTACB SMITH & WESSON® SPECIAL TACTICAL®

Blade Length
3.5" (8.9 cm)
Overall Length
8.1" (20.6 cm)
Weight
3.5 oz.
UPC
028634000777



CKTACBS SMITH & WESSON® SPECIAL TACTICAL®

Blade Length
3.5" (8.9 cm)
Overall Length
8.1" (20.6 cm)
Weight
3.5 oz.
UPC
028634000784



CKTACBSCP Clam Pack
UPC 028634700226



CKTACBSD SMITH & WESSON® SPECIAL TACTICAL®

Blade Length
3.5" (8.9 cm)
Overall Length
8.1" (20.6 cm)
Weight
3.5 oz.
UPC
028634700240



CKTACBSDCP Clam Pack
UPC 028634704385



CK6AEU SMITH & WESSON® EXTREME OPS®

**7Cr17MoV High Carbon Stainless Steel Blade
Aluminum Handle**

- + Nail Groove
- + Lockback
- + Pocket Clip

Blade Length
3.5" (8.9 cm)
Overall Length
8.1" (20.6 cm)
Weight
3.9 oz.
UPC
028634701865



CK108 SMITH & WESSON® 24-7®

**7Cr17MoV High Carbon Stainless Steel Blade
Aluminum Handle**

- + Thumb Hole
- + Lockback
- + Pocket Clip

Blade Length
2.9" (7.4 cm)
Overall Length
7.2" (18.3 cm)
Weight
2.8 oz.
UPC
028634700417



SW480BS SMITH & WESSON® HOMELAND SECURITY®

**7Cr17MoV High Carbon Stainless Steel Blade
Aluminum Handle**

- + Dual Thumb Knobs
- + Liner Lock
- + Pocket Clip

Blade Length
3.4" (8.6 cm)
Overall Length
8.1" (20.7 cm)
Weight
3.8 oz.
UPC
028634700301



CK109 SMITH & WESSON® 24-7®

**7Cr17MoV High Carbon Stainless Steel Blade
Aluminum Handle**

- + Dual Thumb Knobs
- + Lockback
- + Pocket Clip

Blade Length
3.0" (7.6 cm)
Overall Length
7.4" (18.7 cm)
Weight
2.8 oz.
UPC
028634700424





CK32C SMITH & WESSON® EXTREME OPS®

**7Cr17MoV High Carbon Stainless Steel Blade
Titanium Coated Stainless Steel Handle**

- + Thumb Hole
- + Frame Lock
- + Finger Hole
- + Pocket Clip

Blade Length
3.0" (7.6 cm)
Overall Length
8.0" (20.3 cm)
Weight
4.7 oz.
UPC
028634010394



CKLPB SMITH & WESSON®

**7Cr17MoV High Carbon Stainless Steel Blade
Stainless Steel Handle**

- + Dual Thumb Knobs
- + Frame Lock

Blade Length
2.3" (5.8 cm)
Overall Length
5.3" (13.5 cm)
Weight
1.0 oz.
UPC
028634001422



CKLPBCP Clam Pack
UPC 028634001439



Actual Size

CK33 SMITH & WESSON® EXTREME OPS®

**7Cr17MoV High Carbon Stainless Steel Blade
G-10 Handle**

- + Dual Thumb Knobs
- + Liner Lock
- + Finger Hole
- + Pocket Clip

Blade Length
3.1" (8.0 cm)
Overall Length
7.8" (19.8 cm)
Weight
6.8 oz.
UPC
028634010486



CKLPR SMITH & WESSON®

**7Cr17MoV High Carbon Stainless Steel Blade
Stainless Steel Handle**

- + Dual Thumb Knobs
- + Frame Lock

Blade Length
2.3" (5.8 cm)
Overall Length
5.3" (13.5 cm)
Weight
1.0 oz.
UPC
028634990689



CKLPRCP Clam Pack
UPC 028634990702



Actual Size

SWF4LM SMITH & WESSON® FIXED BLADE

**7Cr17MoV High Carbon Stainless Steel Blade
Micarta Handle**

+ Ballistic Sheath w/Sharpening Stone

Blade Length
5.8" (14.6 cm)
Overall Length
11.2" (28.6 cm)
Weight
9.6 oz.
UPC
028634708581



SWF4LMCP Clam Pack
UPC 028634708765



*Horizontal/Vertical &
Left/Right Carry Options*

SWF5LM SMITH & WESSON® FIXED BLADE

**7Cr17MoV High Carbon Stainless Steel Blade
Micarta Handle**

+ Ballistic Sheath w/Sharpening Stone

Blade Length
6.3" (16.0 cm)
Overall Length
11.1" (28.2 cm)
Weight
11.3 oz.
UPC
028634708598



SWF611 SMITH & WESSON® FIXED BLADE

NEW

**8Cr13MoV High Carbon Stainless Steel Blade
TPE Handle**

+ Multi-Carry Option Thermoplastic Belt Sheath

Blade Length
4.6" (11.8 cm)
Overall Length
9.3" (23.6 cm)
Weight
7.5 oz.
UPC
028634709335



SWF603 SMITH & WESSON® FIXED BLADE

NEW



**Stone Washed 8Cr13MoV High Carbon S.S. Blade
G-10 Handle**

- + Full Tang
- + Thermoplastic Belt Sheath

Blade Length
4.9" (12.6 cm)
Overall Length
10.0" (25.4 cm)
Weight
10.3 oz.
UPC
28634709007



Paracord Lanyard



SWF604 SMITH & WESSON® FIXED BLADE

NEW

**8Cr13MoV High Carbon Stainless Steel Blade
G-10 Handle**

- + Full Tang
- + Thermoplastic Belt Sheath

Blade Length
5.0" (12.7 cm)
Overall Length
10.0" (25.4 cm)
Weight
9.9 oz.
UPC
28634709021



Paracord Lanyard



SWF6 SMITH & WESSON® FIXED BLADE

NEW



**Ti-Nitride Coated 8Cr13MoV High Carbon S.S. Blade
TPE Handle**

- + Full Tang
- + Polyester Belt Sheath

Blade Length
4.4" (11.1 cm)
Overall Length
9.1" (23.1 cm)
Weight
7.7 oz.
UPC
028634709489



SWF6CP Clam Pack
UPC 028634709496

SWF1L SMITH & WESSON® FIXED BLADE

**7Cr17MoV High Carbon Stainless Steel Blade
G-10 Handle**

- + Full Tang
- + Nylon Belt Sheath

Blade Length
4.4" (11.1 cm)
Overall Length
9.2" (23.4 cm)
Weight
7.6 oz.
UPC
028634707652



SWF1LCP Clam Pack
UPC 028634707836



SWF2 SMITH & WESSON® FIXED BLADE

**7Cr17MoV High Carbon Stainless Steel Blade
G-10 Handle**

+ Ballistic Sheath

Blade Length
4.8" (12.2 cm)
Overall Length
9.8" (25.0 cm)
Weight
10.4 oz.
UPC
028634708567



SWF2CP Clam Pack
UPC 028634708864

SWF3L SMITH & WESSON® FIXED BLADE

**7Cr17MoV High Carbon Stainless Steel Blade
G-10 Handle**

+ Ballistic Sheath

Blade Length
6.4" (16.2 cm)
Overall Length
11.9" (30.1 cm)
Weight
15.5 oz.
UPC
028634708574



SWF3LCP Clam Pack
UPC 028634708871

SW910TAM SMITH & WESSON® NECK KNIFE

Blade Length
2.8" (7.1 cm)
Overall Length
5.9" (15.0 cm)
Weight
1.8 oz.
UPC
028634707737



SW910TAMCP Clam Pack
UPC 028634707744



7Cr17MoV High Carbon S.S. Blade

- + Full Tang w/550 Paracord Wrapped Handle
- + Nylon Fiber Neck Sheath w/Breakaway Chain

SW910 SMITH & WESSON® NECK KNIFE

Blade Length
3.4" (8.6 cm)
Overall Length
7.9" (20.0 cm)
Weight
3.4 oz.
UPC
028634707492



7Cr17MoV High Carbon S.S. Blade

- + Full Tang w/550 Paracord Wrapped Handle
- + Nylon Fiber Neck Sheath w/Pocket Clip

SW910TA SMITH & WESSON® NECK KNIFE

Blade Length
3.4" (8.6 cm)
Overall Length
7.9" (20.0 cm)
Weight
3.4 oz.
UPC
028634707508



SW910TACP Clam Pack
UPC 028634707690

SWF606 SMITH & WESSON® FIXED BLADE

NEW

**Stone Washed 8Cr13MoV High Carbon S.S. Blade
TPE Handle**

- + Full Tang
- + Leather Boot/Belt Sheath

Blade Length
4.4" (11.1 cm)
Overall Length
8.6" (22.0 cm)
Weight
5.8 oz.
UPC
028634709113

No Ship CA, NY, MA
(SWF606 only)

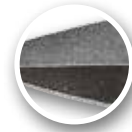

SWF606FCP False Edge
UPC 028634709120 Clam Pack



SWF606GR SMITH & WESSON® FIXED BLADE

NEW

**Stone Washed 8Cr13MoV High Carbon S.S. Blade
G-10 Handle**

- + Full Tang
- + Leather Boot/Belt Sheath

Blade Length
4.4" (11.1 cm)
Overall Length
8.6" (22.0 cm)
Weight
5.8 oz.
UPC
028634709137

No Ship CA, NY, MA



SWHRT3 SMITH & WESSON® H.R.T.®

**7Cr17MoV High Carbon Stainless Steel Blade
TPR Handle**

- + Nylon/Fiberglass Sheath

Blade Length
3.5" (8.9 cm)
Overall Length
7.5" (19.1 cm)
Weight
4.6 oz.
UPC
028634892303

No Ship CA, NY, MA

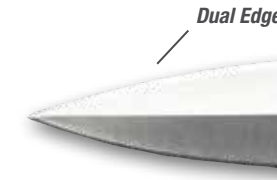

SWHRT3BF SMITH & WESSON® H.R.T.®

**7Cr17MoV High Carbon Stainless Steel Blade
TPR Handle**

- + Nylon/Fiberglass Sheath

Blade Length
3.5" (8.9 cm)
Overall Length
7.5" (19.1 cm)
Weight
4.4 oz.
UPC
028634892310

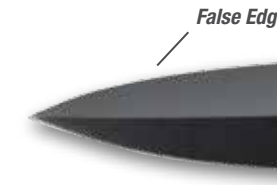

SWHRT7T SMITH & WESSON® H.R.T.®

**7Cr17MoV High Carbon Stainless Steel Blade
TPE Handle**

- + Leather Sheath

Blade Length
4.7" (12.1 cm)
Overall Length
9.0" (22.9 cm)
Weight
7.2 oz.
UPC
028634932108



SWHRT9B SMITH & WESSON® H.R.T.®

**7Cr17MoV High Carbon Stainless Steel Blade
TPE Handle**

- + Leather Sheath

Blade Length
4.7" (12.1 cm)
Overall Length
9.0" (22.9 cm)
Weight
7.7 oz.
UPC
028634939206

No Ship CA, NY, MA
(SWHRT9B/SWHRT9BCP only)



SWHRT9BCP Clam Pack
UPC 028634703456



SWHRT9BF False Edge
UPC 028634705450
SWHRT9BFCP False Edge
UPC 028634705047 Clam Pack



SW7 SMITH & WESSON® SPECIAL OPS®



**9Cr17MoV High Carbon Stainless Steel Blade
TPE Handle**

+ Ambidextrous Sheath

Blade Length
5.2" (13.2 cm)
Overall Length
10.6" (26.9 cm)
Weight
8.5 oz.
UPC
028634706075



SW7S SMITH & WESSON® SPECIAL OPS®

**9Cr17MoV High Carbon Stainless Steel Blade
TPE Handle**

+ Ambidextrous Sheath

Blade Length
5.2" (13.2 cm)
Overall Length
10.6" (26.9 cm)
Weight
8.5 oz.
UPC
028634706099



CKSUR1 SMITH & WESSON® SEARCH & RESCUE®



**7Cr17MoV High Carbon Stainless Steel Blade
Rubberized Aluminum Handle**

+ Ballistic Sheath w/Sharpening Stone

Blade Length
6.0" (15.3 cm)
Overall Length
10.5" (26.7 cm)
Weight
7.4 oz.
UPC
028634892655



CKSUR2 SMITH & WESSON® SEARCH & RESCUE®

**7Cr17MoV High Carbon Stainless Steel Blade
Rubberized Aluminum Handle**

+ Ballistic Sheath w/Sharpening Stone

Blade Length
6.0" (15.3 cm)
Overall Length
10.5" (26.7 cm)
Weight
7.4 oz.
UPC
028634892662



CKSUR2CP Clam Pack
UPC 028634892693



CKSURT SMITH & WESSON® SEARCH & RESCUE®

**7Cr17MoV High Carbon Stainless Steel Blade
Rubberized Aluminum Handle**

+ Ballistic Sheath w/Sharpening Stone

Blade Length
6.0" (15.3 cm)
Overall Length
10.5" (26.7 cm)
Weight
7.9 oz.
UPC
028634892648



CKSURTCP Clam Pack
UPC 028634892679

CKSURTC SMITH & WESSON® SEARCH & RESCUE®

**7Cr17MoV High Carbon Stainless Steel Blade
Rubberized Aluminum Handle**

+ Ballistic Sheath w/Sharpening Stone

Blade Length
6.0" (15.3 cm)
Overall Length
10.5" (26.7 cm)
Weight
7.9 oz.
UPC
028634707324



CKSURC SMITH & WESSON® HOMELAND SECURITY®

**7Cr17MoV High Carbon S.S. Blade
G-10 Handle**

+ Ballistic Sheath w/Sharpening Stone

Blade Length
8.6" (22.0 cm)
Overall Length
13.8" (34.9 cm)
Weight
1 lb. 14.2 oz.
UPC
028634892600



CKSUR4N SMITH & WESSON® HOMELAND SECURITY®

**7Cr17MoV High Carbon S.S. Blade
G-10 Handle**

+ Ballistic Sheath w/Sharpening Stone

Blade Length
6.0" (15.2 cm)
Overall Length
11.8" (29.8 cm)
Weight
1 lb. 10.0 oz.
UPC
028634705399



CKSUR4NCP Clam Pack
UPC 028634705139



SW1B SMITH & WESSON® M-9 BAYONET

**420J2 Stainless Steel Blade
Nylon Fiber Handle**

+ Scabbard w/Sharpening Stone

Blade Length
7.1" (18.1 cm)
Overall Length
12.2" (31.0 cm)
Weight
14.1 oz.
UPC
028634700554

Dual Edge Spear Point Blade
w/Partially Serrated Saw Spine



WIRE CUTTER



SW3B SMITH & WESSON® M-9 BAYONET

**420J2 Stainless Steel Blade
Nylon Fiber Handle**

+ Scabbard w/Sharpening Stone

Blade Length
7.8" (19.7 cm)
Overall Length
12.8" (32.6 cm)
Weight
14.6 oz.
UPC
028634700592

Spear Point Blade w/Notched Spine



WIRE CUTTER



SW3BCP Clam Pack
UPC 028634706631

SW3G SMITH & WESSON® M-9 BAYONET

**420J2 Stainless Steel Blade
Nylon Fiber Handle**

+ Scabbard w/Sharpening Stone

Blade Length
7.8" (19.7 cm)
Overall Length
12.8" (32.6 cm)
Weight
14.6 oz.
UPC
028634700608

Spear Point Blade w/Notched Spine



WIRE CUTTER





CK300, CK301 and CH200
(Only available in SWCAMP combo)

CK300

Overall 10.7" (27.2 cm)
Weight 12.5 oz.



CK301

Overall 6.6" (16.8 cm)
Weight 2.1 oz.



CH200

Overall 9.5" (24.1 cm)
Weight 8.9 oz.



CH100 and CH200
(Only available in CH629 combo)

CH100

Overall 10.7" (27.2 cm)
Weight 1 lb. 5.6 oz.



CH200

Overall 9.5" (24.1 cm)
Weight 8.9 oz.



SWCAMP / SMITH & WESSON® 3 PC. CAMPING SET

Blade Steel 3Cr13 High Carbon S.S. Handle Material Rubberized Steel UPC 028634002016

CH629 / SMITH & WESSON® HATCHET/KNIFE COMBO

Blade Steel 3Cr13 Stainless Steel Handle Material Rubberized Steel UPC 028634381029

SWFS1 SMITH & WESSON® SURVIVAL KIT



- SWFS1** Includes
- + Compass
 - + 6 - Matches
 - + Match Strike
 - + Ferro Rod w/Striking Plate
 - + 2 - Needles
 - + 2 - Fishing Hooks
 - + 2 - Split Shots
 - + Fishing Line

Ferro Rod
 Overall Length
 4.2" (10.6 cm)
 Weight
 0.7 oz.
 UPC
 028634704019



SW8 SMITH & WESSON® SPEAR

3Cr13 Stainless Steel Blade
Glass Filled Nylon Handle

- + Screws Onto Common Broom Handle Thread
- + Nylon Belt Sheath

Blade Length
 4.2" (10.7 cm)
Overall Length
 10.7" (27.2 cm)
Weight
 8.5 oz.
 UPC
 028634706648



SWTK8BCP SMITH & WESSON® THROWING KNIVES

NEW

- 2Cr13 Stainless Steel**
- + Three, 8" Throwing Knives
 - + Nylon Belt Sheath

Overall Length
 8.0" (20.3 cm)
Overall Weight
 12.3 oz.
Individual Weight
 4.1 oz.
 UPC
 028634708963

Only available in clam pack



SWTK8CP SMITH & WESSON® THROWING KNIVES

- 2Cr13 Stainless Steel**
- + Six, 8" Throwing Knives
 - + Nylon Belt Sheath

Overall Length
 8.0" (20.3 cm)
Overall Weight
 1 lb. 12.2 oz.
Individual Weight
 4.7 oz.
 UPC
 028634706280

Only available in clam pack



SWTK10CP SMITH & WESSON® THROWING KNIVES

- 2Cr13 Stainless Steel**
- + Three, 10" Throwing Knives
 - + Nylon Belt Sheath

Overall Length
 10.0" (25.4 cm)
Overall Weight
 1 lb. 5.1 oz.
Individual Weight
 7.0 oz.
 UPC
 028634706297

Only available in clam pack



SWBH

SMITH & WESSON® KUKRI

**7Cr17MoV High Carbon Stainless Steel Blade
Rubberized Steel Handle**

- + Full Tang
- + Nylon Belt Sheath w/Shoulder Strap

Blade Length
11.9" (30.2 cm)
Overall Length
17.0" (43.2 cm)
Weight
1 lb. 3.8 oz.
UPC
028634990818



SW671

SMITH & WESSON® TOMAHAWK

**1070 High Carbon Steel Blade
TPE & Steel Handle**

- + Full Tang
- + Nylon Sheath

Blade Length
3.9" (9.9 cm)
Overall Length
15.9" (40.4 cm)
Weight
2 lbs. 11.0 oz.
UPC
028634703432



SWRT1 Includes

1. Scope Adjustment Tool
2. Choke Tube Wrench
3. Oxygen Tank Valve Opener
4. Bit Driver (4mm Box Wrench)
5. Front Sight Adjustment Tool
6. Cut Hook
7. Bottle Opener
8. Buffer Wrench
9. Broadhead Wrench
10. 14-Gauge & 15-Gauge Spoke Wrench
11. Flash Hider
12. Carabiner Tool
13. Box Wrench
 - + 1/4", 5/16", 3/8", 7/16", 1/2"
 - + 4mm, 5mm, 6mm, 7mm, 8mm, 10mm, 12mm
14. Replaceable Firearm Disassembly Punch & Hex 4mm
15. Torx #10 & #15
16. Phillips #0 & #2
17. Hex 7/64" & 1/4" Screwdriver
18. Bits Holder

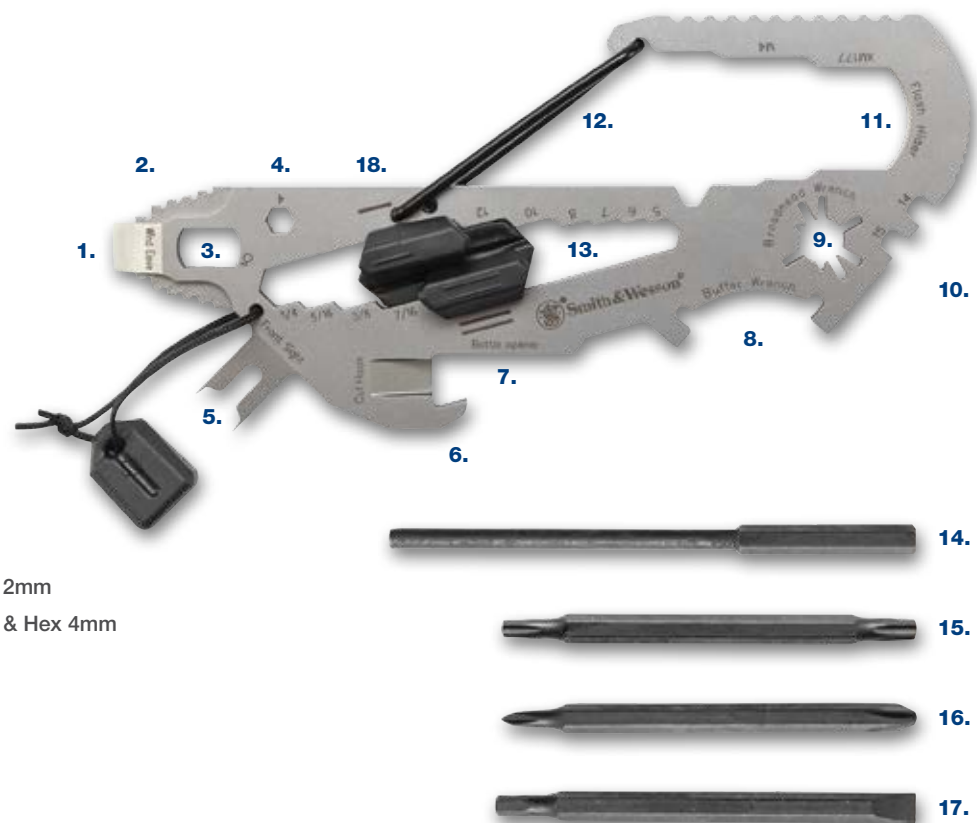

Only available in clam pack

NEW

SWRT1CP RIFLE/SHOTGUN/ARCHERY TOOL

Steel	4034 Steel	Weight	3.7 oz.
Overall Length	5.5" (14.0 cm)	UPC	028634709410



SWUAT1 Includes

- + 1/16" Allen Wrench
- + 1/16" Roll Tip Punch Pin
- + 1/8" Roll Tip Punch Pin
- + 1/16" Flat Tip Punch Pin
- + 1/8" Flat Tip Punch Pin
- + M&P Slave Pin
- + 1/8" Solid Punch Pin
- + 1/8" Brass Flat Tip Punch Pin
- + 1/8" Brass Roll Tip Punch Pin
- + 1/32" Cut Tip Punch Pin
- + 1/16" Cut Tip Punch Pin
- + 1/8" Cut Tip Punch Pin



SWUAT1CP Clam Pack
UPC 028634705894

SWUAT1 SMITH & WESSON® UNIVERSAL ARMORER TOOL

Steel	Aluminum	Weight	2.0 oz.
Overall Length	5.1" (13.0 cm)	UPC	028634705887



SWMT1 Functions

- + Needle Nose Plier
- + Regular Plier
- + Wire Cutter
- + Fine Edge Blade
- + Small Phillips Head
- + Can Opener
- + Ruler
- + Fine Grit File
- + Hexagon Wrench - 3 Sizes
- + Large Screwdriver
- + Bottle Opener
- + Nail Puller
- + Small Screwdriver
- + Saw
- + Spring Loaded



Only available in clam pack

SWMT1CP / SMITH & WESSON® MULTI-TOOL

Steel	2Cr13 Stainless Steel	Weight	8.6 oz.
Closed Length	4.2" (10.6 cm)	SWMT1CP CLAM PACK	
Overall Length	6.5" (16.5 cm)	UPC	028634706877



SWMT2 Functions

- + Needle Nose Pliers
- + Regular Pliers
- + Wire Cutter
- + Wire Stripper
- + Fine Edge Blade
- + Coarse File
- + Fine File
- + Large Flat Head Screwdriver
- + Saw
- + Scissors
- + Medium Phillips Head
- + Medium Flat Head Screwdriver
- + Small Phillips Head
- + Small Flat Head Screwdriver
- + Carabineer Clip



Only available in clam pack

SWMT2CP / SMITH & WESSON® MULTI-TOOL

Steel	2Cr13 Stainless Steel	Weight	7.8 oz.
Closed Length	4.4" (11.1 cm)	SWMT2CP CLAM PACK	
Overall Length	6.0" (15.11 cm)	UPC	028634707645

SWPENMP2BK M&P® SMITH & WESSON®

T6061 Aircraft Aluminum

- + Screw Cap Pen
- + Schmidt P900M Parker Style Black Ball Point Pen Refill

Overall Length
5.8" (14.7 cm)

Weight
1.4 oz.

UPC
028634704897



SWPENMPBK M&P® SMITH & WESSON®

T6061 Aircraft Aluminum

- + Pull Cap Pen
- + Schmidt P900M Parker Style Black Ball Point Pen Refill

Overall Length
6.1" (15.5 cm)

Weight
1.4 oz.

UPC
028634702961



SWPENMP2BL M&P® SMITH & WESSON®

T6061 Aircraft Aluminum

- + Screw Cap Pen
- + Schmidt P900M Parker Style Black Ball Point Pen Refill

Overall Length
5.8" (14.7 cm)

Weight
1.4 oz.

UPC
028634704927



SWPENMPG M&P® SMITH & WESSON®

T6061 Aircraft Aluminum

- + Pull Cap Pen
- + Schmidt P900M Parker Style Black Ball Point Pen Refill

Overall Length
6.1" (15.5 cm)

Weight
1.4 oz.

UPC
028634702978



SWPENMP2BR M&P® SMITH & WESSON®

T6061 Aircraft Aluminum

- + Screw Cap Pen
- + Schmidt P900M Parker Style Black Ball Point Pen Refill

Overall Length
5.8" (14.7 cm)

Weight
1.4 oz.

UPC
028634704903

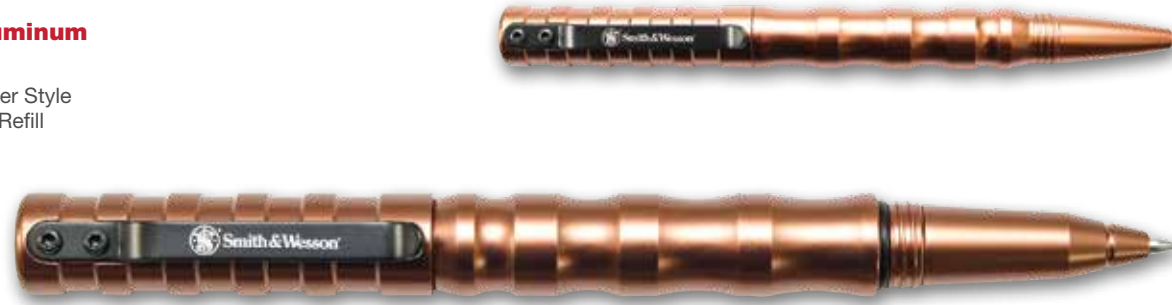

SWPENMPOD M&P® SMITH & WESSON®

T6061 Aircraft Aluminum

- + Pull Cap Pen
- + Schmidt P900M Parker Style Black Ball Point Pen Refill

Overall Length
6.1" (15.5 cm)

Weight
1.4 oz.

UPC
028634702985



SWPENMP2G M&P® SMITH & WESSON®

T6061 Aircraft Aluminum

- + Screw Cap Pen
- + Schmidt P900M Parker Style Black Ball Point Pen Refill

Overall Length
5.8" (14.7 cm)

Weight
1.4 oz.

UPC
028634704910



SWPENMPS M&P® SMITH & WESSON®

T6061 Aircraft Aluminum

- + Pull Cap Pen
- + Schmidt P900M Parker Style Black Ball Point Pen Refill

Overall Length
6.1" (15.5 cm)

Weight
1.4 oz.

UPC
028634702992



SWPEN3BK TACTICAL STYLUS PEN

T6061 Aircraft Aluminum

- + Includes Replacement Stylus Tip
- + Schmidt P900M Parker Style Black Ball Point Pen Refill

Overall Length
5.4" (13.7 cm)

Weight
1.6 oz.

UPC
028634705498



SWPEN3G TACTICAL STYLUS PEN

T6061 Aircraft Aluminum

- + Includes Replacement Stylus Tip
- + Schmidt P900M Parker Style Black Ball Point Pen Refill

Overall Length
5.4" (13.7 cm)

Weight
1.6 oz.

UPC
028634705481



SWPEN3P TACTICAL STYLUS PEN

T6061 Aircraft Aluminum

- + Includes Replacement Stylus Tip
- + Schmidt P900M Parker Style Black Ball Point Pen Refill

Overall Length
5.4" (13.7 cm)

Weight
1.6 oz.

UPC
028634705474



SWPEN3S TACTICAL STYLUS PEN

T6061 Aircraft Aluminum

- + Includes Replacement Stylus Tip
- + Schmidt P900M Parker Style Black Ball Point Pen Refill

Overall Length
5.4" (13.7 cm)

Weight
1.6 oz.

UPC
028634705467



SWPEN3SCP Clam Pack
UPC 028634705580



SWPENBK TACTICAL PEN

T6061 Aircraft Aluminum

- + Screw Cap Pen
- + Schmidt P900M Parker Style Black Ball Point Pen Refill

Overall Length
5.7" (14.5 cm)

Weight
1.4 oz.

UPC
028634702411



SWPENBKCP Clam Pack
UPC 028634703616

SWPENBL TACTICAL PEN

T6061 Aircraft Aluminum

- + Screw Cap Pen
- + Schmidt P900M Parker Style Black Ball Point Pen Refill

Overall Length
5.7" (14.5 cm)

Weight
1.4 oz.

UPC
028634702428





Smith & Wesson®



NEW

HRC 59-61

SWBATGB1 / GLASS BREAKER

Steel S45C w/JIS SKD11 Tip Weight 2.8 oz.
Overall Length 1.2" (3.0 cm) UPC 028634709465



NEW

HRC 59-61

SWBATGB2 / ROUNDED GLASS BREAKER

Steel S45C w/JIS SKD11 Tip Weight 6.7 oz.
Overall Length 1.7" (4.4 cm) UPC 028634709472

4130 Seamless Alloy Steel Tubing w/HRC 46-47

- + Textured & Raised Rubber Handle
- + 1680 Denier Outer Shell Belt Sheath (M.O.L.L.E. Compatible)



Tensile Strength 6,639 lbf (3,011 kgf)
Bending Strength 4,056 lbf (1,840 kgf)

SWBAT16H / COLLAPSIBLE BATON

Overall Length 16.0" (40.5 cm)
Handle Length 6.6" (16.7 cm)
Weight 13.9 oz.
UPC 028634703012



SWBAT16HCP Clam Pack
UPC 028634703166



SWBAT21H / COLLAPSIBLE BATON

Overall Length 21.0" (53.3 cm)
Handle Length 8.2" (20.8 cm)
Weight 1 lb. 1.1 oz.
UPC 028634703029



SWBAT21HCP Clam Pack
UPC 028634703173



SWBAT24H / COLLAPSIBLE BATON

Overall Length 24.0" (60.9 cm)
Handle Length 9.2" (23.3 cm)
Weight 1 lb. 2.9 oz.
UPC 028634703036



SWBAT24HCP Clam Pack
UPC 028634703180



SWBAT26H / COLLAPSIBLE BATON

Overall Length 26.0" (66.0 cm)
Handle Length 9.7" (24.6 cm)
Weight 1 lb. 3.8 oz.
UPC 028634703043



SWBAT26HCP Clam Pack
UPC 028634703197



Tip Steel 1215MS Free Cutting Steel
First Shaft Steel STKM 11A Carbon Steel
Middle Shaft Material 7076 T6 Aluminum

- + 7076 T6 Aluminum Handle w/Soft Foam Grip
- + 1680 Denier Outer Shell Belt Sheath



Tensile Strength 2,653 lbf (1,204 kgf)
 Bending Strength 1,986 lbf (901 kgf)

SWBAT16LT COLLAPSIBLE LITE BATON **NEW**

Overall Length
16.0" (40.5 cm)
 Handle Length
6.5" (16.5 cm)
 Weight
7.2 oz.
 UPC
028634709427



SWBAT21LT COLLAPSIBLE LITE BATON **NEW**

Overall Length
21.0" (53.3 cm)
 Handle Length
8.1" (20.5 cm)
 Weight
8.8 oz.
 UPC
028634709434



SWBAT24LT COLLAPSIBLE LITE BATON **NEW**

Overall Length
24.0" (60.9 cm)
 Handle Length
9.4" (23.9 cm)
 Weight
9.7 oz.
 UPC
028634709441

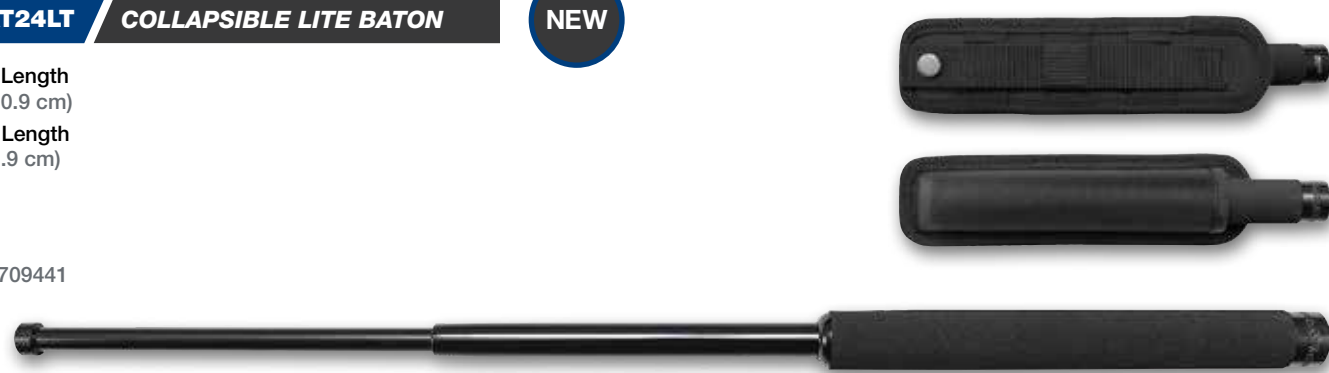

SWBAT26LT COLLAPSIBLE LITE BATON **NEW**

Overall Length
26.0" (66.0 cm)
 Handle Length
9.6" (24.5 cm)
 Weight
10.6 oz.
 UPC
028634709458



SWBAT12B Features

- + Includes Handheld Sheath for Jogging, Walking and Hiking
- + Pocket Clip



SWBAT12BCP Clam Pack
 UPC 028634705870



SWBAT12B SMITH & WESSON® SMALL COLLAPSIBLE BATON

Steel	STKM-11A Carbon Steel	Overall Length	12.1" (30.7 cm)
Handle Material	STKM-11A Carbon Steel	Weight	8.9 oz.
Handle Length	5.0" (12.7 cm)	UPC	028634705863

SWBAT12P Features

- + Includes Handheld Sheath for Jogging, Walking and Hiking
- + Pocket Clip



SWBAT12PCP Clam Pack
 UPC 028634705856



SWBAT12P SMITH & WESSON® SMALL COLLAPSIBLE BATON

Steel	STKM-11A Carbon Steel	Overall Length	12.1" (30.7 cm)
Handle Material	7076 T6 Aluminum	Weight	7.4 oz.
Handle Length	5.0" (12.7 cm)	UPC	028634705849



Smith & Wesson®

SWD1/SWS1 SMITH & WESSON® 6" DECAL & STICKER

SWD1 (Window Decal) SWS1 (Sticker)
 UPC 028634708796 UPC 028634708789

SWPLEXSD PLEXIGLASS STANDING DISPLAY

UPC 028634707577

SWPED Features

+ Extra Storage

TBD1 Features

- + Magnetic Display
- + Extra Storage



+ Smith & Wesson® Header For TBD1

HSW UPC 028634707386



TBD1 ROTATABLE COUNTER DISPLAY

UPC 044356224062



SWPED SMITH & WESSON® FLOOR PEDESTAL DISPLAY

UPC 044356708772

