

Log Furniture Facts

As with all rustic and log furniture, some cracking (or checking) may develop during the log drying process. Cracking occurs mainly on the your furniture. Some cracking is to be expected and it is a natural characteristic of all log furniture.

Cracking usually occurs from the center of the log, cracking outward in one direction as the wood releases moisture. The degree of cracking will vary from log to log. Some cracks will be wider than others, depending upon the diameter of the log. Typically, logs that are larger in diameter will have larger cracks. This natural process adds to the unique rustic appeal of your log furniture.



Care

Apply lemon oil with a soft cotton cloth. Do not use products with silicones. This may cause damage to the finish. Never let the wood get in contact with any type of paint remover.

Connections

Changes in temperature and humidity will cause the wood to dry out possibly causing the bolts loosen. Check the bolts periodically to make sure they are still tight. DO NOT put your wood piece directly against hot radiators or sources of heat. Doing this may cause the wood to dry and crack.







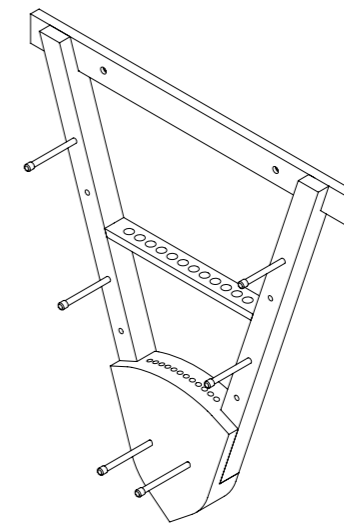

Bow and Arrow Rack

Item #
39-4008

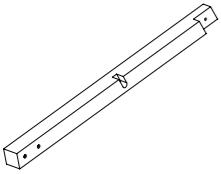
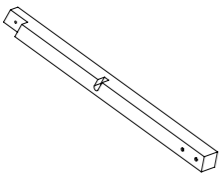
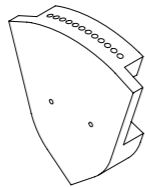
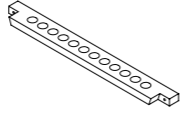
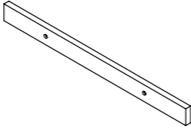
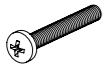

Please keep this instruction manual for future reference

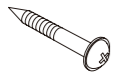
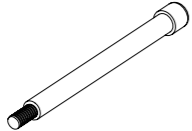
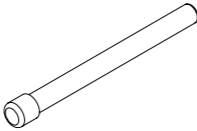
Parts List

| | | | | |
|--|--|--|---|--|
| 1  x1 | 2  x1 | 3  x1 | 4  x1 | 5  x1 |
| 6  x4 | 7  x2 | 8  x4 | 9  x2 | 10  x2 |
| 11  x2 | 12  x2 | 13  x4 | 14  x2 | 15  x1 |

