



FAST • AFFORDABLE • FUN

BLACKOUT

XTE PRO



1/10 SCALE MONSTER TRUCK

USER MANUAL

[RC CARS & TRUCKS](#)

WARNING!

READ ALL INSTRUCTIONS INCLUDED WITH VEHICLE BEFORE OPERATING



Age warning: This radio controlled vehicle is not a toy! You must be 14yrs of age or older to operate this vehicle. Adult supervision is required.



RISK OF FIRE!

RISK OF EXPLOSION!

There is a risk of fire and explosion when dealing with Fuel and Batteries.

Nitro fuel contains Nitromethane and Methyl alcohol. These chemicals are highly flammable and explosive. Only use in well ventilated areas. Keep away from fire, spark, and heat. Store in a cool place away from heat. **NEVER SMOKE AROUND FUEL OF ANY KIND!**



Only use in a well ventilated area. Never run your engine indoors.

Rechargeable batteries may become hot and catch fire if left unattended or charged too quickly. Use extra caution when charging LiPO batteries. Use only LiPO specific chargers. Charge away from flammable materials. Never charge at a rate higher than 1S. (2000Mah pack = 2amps charge rate). Overcharging can lead to fire and explosion. Always store battery packs in a cool place.



POISONOUS!

Fuels contain Nitromethane and Methyl alcohol and are toxic. Injury or death can occur if swallowed. May irritate skin and cause injury if absorbed into the skin. Injury or death can occur from breathing the toxic fumes. **KEEP AWAY FROM CHILDREN AND PETS!** Always follow manufacturer's recommendations on fuel container.



RISK OF BURNS!

The engine, exhaust pipe, batteries, electronic speed controller, electric motor, and other areas of the vehicle get hot. Burns can occur if touched after vehicle operation. Allow adequate time to cool before handling.



RISK OF ELECTRICAL SHOCK!

Use caution when charging batteries. Do not touch positive and negative leads together. Do not lay battery on metal. Use only chargers specified for the battery type being charged. Keep batteries and chargers away from water.



RISK OF INJURY!

Hobby grade RC vehicles can cause serious injury or death if not operated correctly. Never use vehicle in crowds. Never chase people or animals. Drive in safe open areas only. Keep body parts away from moving parts.



RISK OF DAMAGE!

Never operate RC vehicles on public roads. Damage of vehicle and property can occur. Only operate on open private property.

Welcome to the world of hobby grade RC

Recommended for ages 14+ (with adult supervision)

Congratulations on your new hobby grade radio control vehicle. Hobby grade RCs offer many advantages over radio controlled vehicles sold in the toy department. One of the greatest advantages to hobby grade RC vehicles is the ability to set up the vehicle the way YOU want it. This includes tuning the motor for top performance, changing gear ratios to better suit your terrain, tuning the many adjustable suspension components like changing ride height and geometry, as well as customizing the overall appearance of your vehicle. Redcat Racing hobby grade RC vehicles were designed with all these characteristics in mind to provide you with much fun and adjustability.

Redcat hobby grade RC vehicles are incredibly fast with some reaching speeds of 40 mph. While this is fun and exciting, it also comes with a great deal of responsibility. A 10-20 pound RC vehicle traveling at 30 mph carries much momentum. Getting hit in the leg at that speed is like being hit with a sledge hammer and serious injury may occur. Property damage as well as damage to your RC vehicle are also possible. Great care must be used while operating these vehicles.

This is not a toy and should not be treated as one. These two-stroke gas engines are highly tuned pieces of equipment and need to be used only as directed. Follow the included instructions closely and be sure to keep hands away from the hot surfaces of the engine and exhaust pipe. Make sure you read all included manuals completely before attempting to start your gas powered RC vehicle.

The engine in this RC vehicle runs on a mixture of unleaded gasoline and two-stroke oil. Proper mixture ratios is crucial in having a good running vehicle that will last. Gas is dangerous for many reasons. Highly flammable, explosive fumes, and poisonous chemicals are a few reasons gas should be handled with care. Gasoline should be used by an adult and always within it's safety confinements. When mixing gas with two-stroke oil, never guess at the amounts used. Use a gas/oil mixing container designed for mixing fuel for two-stroke engines. Always use special two-stroke oil. You can find these products at hardware stores and automotive stores.

Redcat radio controlled vehicles are engineered for performance as well as durability. This means shedding weight where ever possible and using complex suspension components that offer many tuning options. This allows the operator to make adjustments that will effect the way the vehicle responds to all aspects of the terrain. As you may know, any RC vehicle, whether it be hobby or toy grade, can break. How and when it breaks depends solely on your driving style. Unlike toy grade RCs, hobby grade RCs are designed with parts replacement in mind. Spare parts are readily available from Redcat and more durable aluminum parts are available as well. It is recommended to keep spare parts on hand so if you run into that oak tree at full speed, you will have the necessary replacement parts to get you up and running again quickly.

Appearance is just as important as speed and handling. Who wants to go fast and look good doing it? You do! That is why Redcat has also designed their vehicles to look as good as they perform. Accessories may also be added to your vehicle to customize its looks. As mentioned earlier, Redcat hobby grade RC vehicles can be completely customized, so the fun never ends.

Imagine yourself being on the pit crew of a full scale monster truck. Making suspension adjustments for smoother landings or changing the gearing to get that hole-shot from the start. That is the feeling you will get when adjusting the suspension on your new Redcat. Increase ride height so you can clear the driveway with a single jump or thicken the oil inside the oil filled shocks to make high speed laps around your front yard. The possibilities are endless with Redcat, so put on you favorite pit crew cap, grab your Redcat and have the time of your life!

Features:

- KV 3800 Brushless Electric Motor
- Waterproof 45 Amp ESC LIPO Ready
- Forward & Reverse
- 4 Wheel Drive
- Big Bore Aluminum Oil Filled Shocks
- 7.4v 3200mAh 20c LIPO Pack
- LIPO Battery Charger
- 2.4GHz Radio System
- 15KG Waterproof Metal Gear Steering Servo

Specifications:

- Scale: 1/10
- Length: 440mm
- Width: 275mm
- Height: 140mm (without body)
- Wheelbase: 290mm
- Ground Clearance: 40mm (adjustable)
- ESC: 45 Amp
- Motor: KV 3800
- Battery: 7.4V 3200mAh

Required equipment for operation

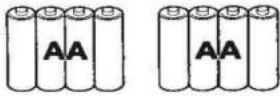

8pcs AA alkaline batteries for transmitter

Tools required for maintenance:

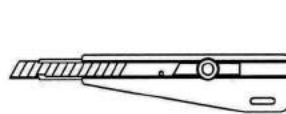

• Hobby knife

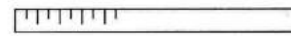

• Precision ruler

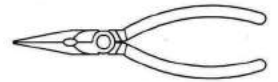

• Needle nose pliers

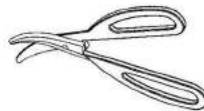

• Lexan scissors

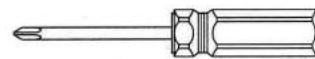

• Flat and Philips screwdriver

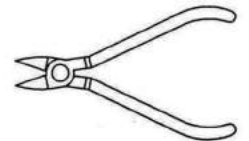

• Wire cutters

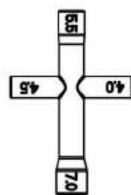

• Cross wrench

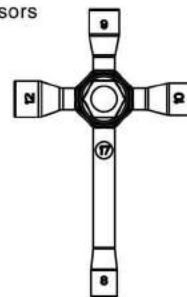

• Cross wrench



• CA glue & rubber cement

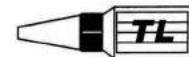

• Thread locking compound



• Hex wrench

WARNING:

Never use a drill or powered screw driver while working on R/C vehicles. The heat generated from fast turning screws can melt the threads inside the plastic. This can cause loose parts, resulting in poor performance, premature wear, and breakage.

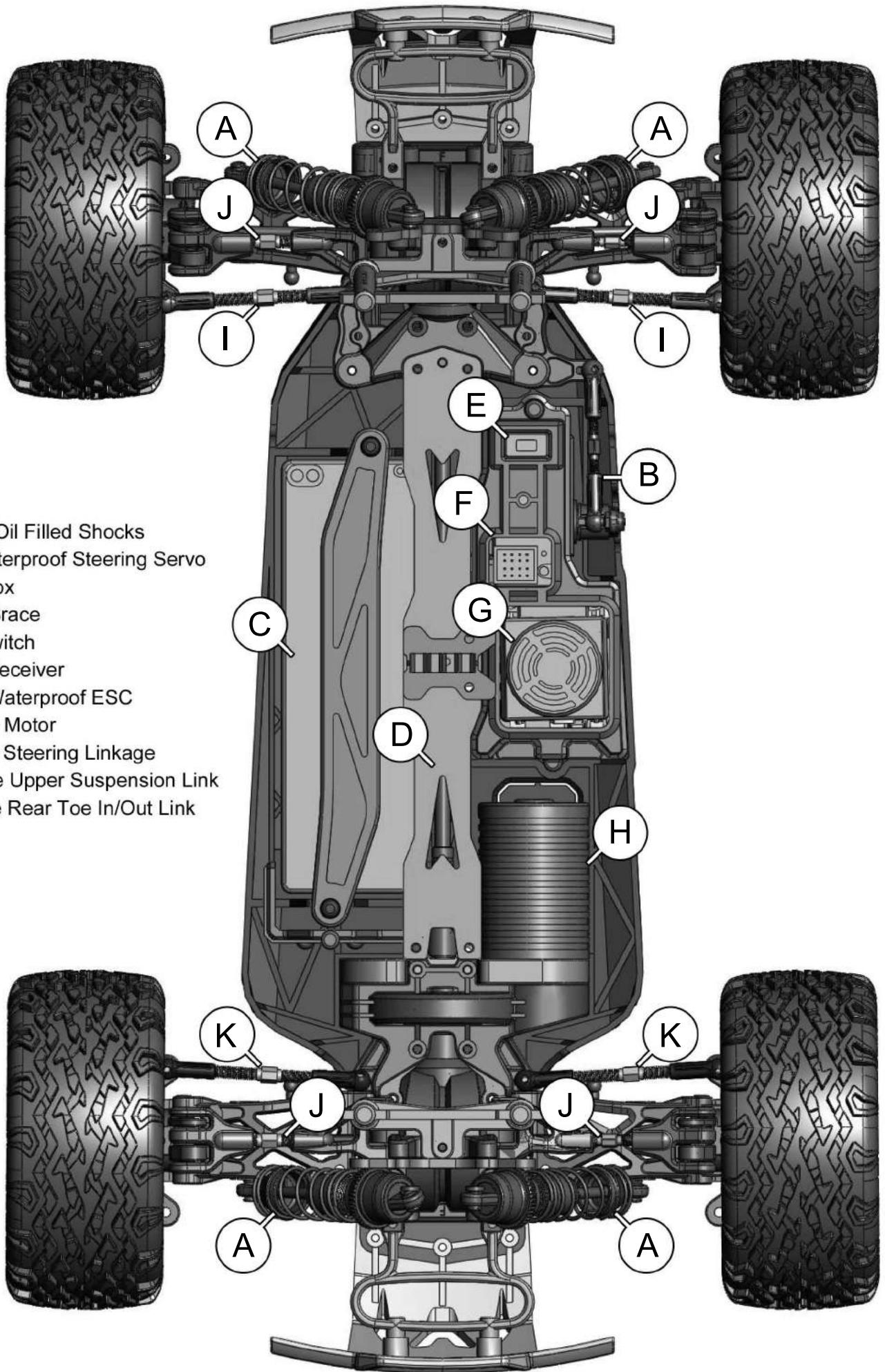

- A: Big Bore Oil Filled Shocks
- B: 15KG Waterproof Steering Servo
- C: Battery Box
- D: Chassis Brace
- E: On/Off Switch
- F: 2.4GHz Receiver
- G: 45 Amp Waterproof ESC
- H: Brushless Motor
- I: Adjustable Steering Linkage
- J: Adjustable Upper Suspension Link
- K: Adjustable Rear Toe In/Out Link

Unpacking and setting up your new vehicle

The moment you've been waiting for is finally here. Your new Redcat Racing package has arrived. Before you go crazy from excitement, let's go over a few simple steps.

Unboxing your Redcat Racing RC vehicle

- Be sure you've removed all parts, equipment, tools, and documentation from the box. It's easy for small parts to get hidden in the packing materials and overlooked.
- Completely read all documents and instructions included with your vehicle.
- Acquire any necessary items such as battery packs, chargers, transmitter batteries, and any additional tools and supplies that may not be included.

Looking over your Redcat Racing vehicle

1. Be sure to look over your new Redcat Racing RC. This may save you some hassle in the future.
2. Check all screws to make sure they are tight. Do not over tighten screws nested into plastic as this may damage the plastic threads. Avoid using power tools for this step.
3. Check all nuts, bolts, and clips to ensure they are tight and secure.
4. Add medium strength liquid threadlock (like blue Loctite) to any screws threaded into metal parts, especially the motor mounts. Do not apply threadlock to screws threaded into plastic parts, this may damage the plastic threads. Threadlock can be found at auto parts stores.
5. Check all electrical connections. Loose connections create heat that may shorten battery life or worse, cause damage to the vehicle and components.
6. **Perform a radio range check.**
 - Thread the vehicle's antenna through the plastic antenna tube and turn on the transmitter.
 - Keeping fingers away from potentially moving parts, hold the vehicle off the ground and turn on the ESC switch found in the vehicle.
 - Check that the controls are working properly. The steering wheel should operate the steering and the trigger should operate the motor. Pulling the trigger should make the vehicle go forward, pushing the trigger should apply brake and reverse.
 - You may need to adjust the throttle trim found on the transmitter to keep wheels from spinning while trigger is in neutral position.
 - Have a buddy hold the vehicle and walk 50 yards away. You and your buddy decide on a routine since it will be difficult to communicate with each other while testing. An example would be.... turn wheel left and count to ten, turn wheel right and count to ten, Pull trigger and count to ten, and push brakes and count to ten. You will want to repeat these steps moving further out as you progress until you are beyond the maximum distance you plan to run the vehicle.
 - If the radio performed without any glitches or twitching, you are ready.

CONTROL PANEL



RCR-2C RADIO GUIDE

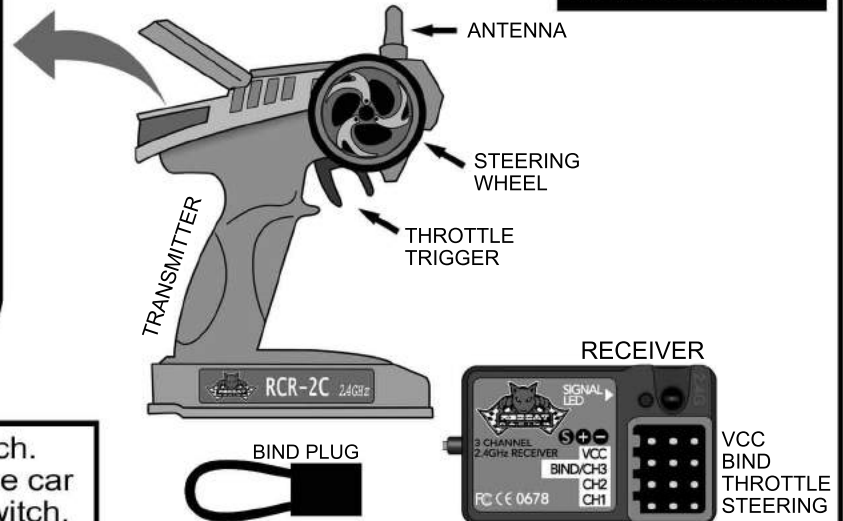

STEERING REVERSE SWITCH: Top left switch. Used to change steering orientation. If the car turns right when you steer left, flip this switch.

THROTTLE REVERSE SWITCH: Top right switch. Used to change throttle trigger orientation. If the car goes in reverse while you pull the throttle trigger, flip this switch.

POWER LED: Left LED light. Lights up when the transmitter is turned on.

BATTERY LEVEL LED: Right LED light. Lights up green when transmitter batteries are full. Flashes when transmitter batteries are low and need replacing.

BIND BUTTON: Used to bind the transmitter to the receiver. See receiver instructions.

STEERING TRIM: Left knob. Used to set the steering neutral point. If the vehicle veers in one direction while the steering wheel is centered, turn this knob in the opposite direction until the car drives straight.

THROTTLE TRIM: Middle knob. Used to set the throttle neutral point. If the vehicle moves forward or reverse while the throttle trigger is centered, turn this knob until the vehicle remains still. For maximum setting, turn slowly until the vehicle creeps forward, then turn the knob the opposite direction until the car stops.

STEERING DUAL RATE: Right knob. Used to limit the amount of steering. 0= little/no steering & 6= maximum steering. Set the knob to the amount of steering you feel comfortable with. If the vehicle has a tendency to spin out, lower the steering rate.

ON/OFF SWITCH: Bottom switch. Turns transmitter On and Off.

VCC: Used for gas and nitro vehicles that require a separate battery pack to power the servos and receiver. Electric vehicles that have an ESC will not utilize this port.

BIND/CH3: Used when binding to transmitter. Used for 3rd channel when needed.

CH2: Electric vehicles - Used for ESC
Nitro vehicles - Used for throttle servo.

CH1: Used for steering servo.

BINDING:

1. Insert the BIND PLUG into the receiver BIND port.
2. If using an electric vehicle, make sure your ESC is plugged into CH2, and insert the bind plug into BIND/CH3. For nitro and gas vehicles, your switch should be plugged into the VCC port, and insert the bind plug into BIND/CH3. Now, power the vehicle on and the receiver light should begin to blink red.
3. Press the BIND button in the center of the transmitter's Control Panel and turn on radio.
4. Release the bind button when you see the green light on the radio flashing. At this point, your receiver's LED should now be solid red. If so, turn off the power to your vehicle, as well as the radio.
5. Remove the BIND PLUG from the receiver and reinstall the servos, battery, and/or ESC according to the paragraph above.
6. Now turn your radio and vehicle on as normal. Your radio and receiver should be bound together and communicating with each other.

CHARGERS

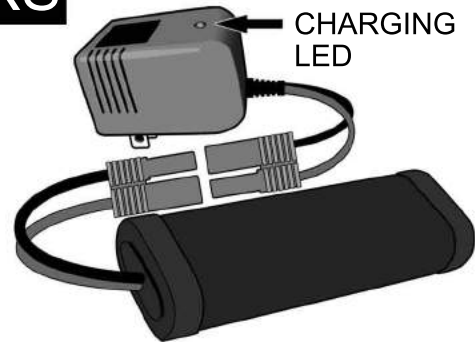
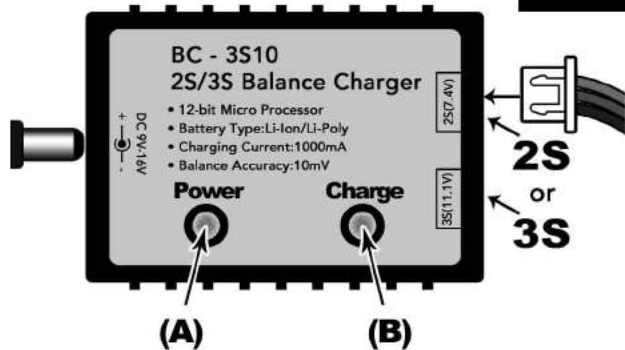

LIPO: The BC - 3S10 Balance charger is capable of charging 2S and 3S LIPO batteries.

DC PORT: Single round port on left end of charger. Plug in DC adapter here.

POWER LED: Left LED light. Lights up when charger is connected to a 110v power source.

CHARGE LED: Right LED light. Blinks while battery is charging. LED light will turn solid red when battery is fully charged

2S PORT: Used to charge 2S 7.4v LIPO battery packs.

3S PORT: Used to charge 3S 11.1v LIPO battery packs.

CHARGING INSTRUCTIONS:

1. Plug the charger into a 110v power receptacle using the included DC power adapter. - Power light will be on.
2. Plug the 2S/3S LIPO battery "balance charge plug" into the appropriate charge port. (as seen above) - Charge light will blink while the LIPO battery is charging.
4. When the charge light turns solid red, unplug the battery as charging is complete.
5. Unplug charger from the 110v power source.

NOTE: LEAVING BATTERY UNATTENDED WHILE CHARGING MAY RESULT IN FIRE AND DAMAGE/INJURY. NEVER LEAVE UNATTENDED WHILE CHARGING. IF BATTERY GETS "HOT", UNPLUG AND LET COOL.

It's normal for the battery pack to get warm, but it should never get hot!

A LIPO SAFE CHARGING BAG SHOULD BE USED WHENEVER CHARGING LIPO BATTERIES TO HELP PREVENT FIRES.

NIMH: Charging NiMh battery packs with the included charger is very simple.

1. Plug the charger into a 110v wall receptacle.

ATTENTION

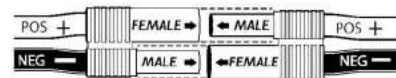

Ensure POS+ wire is connected to POS+ & NEG- is connected to NEG-

2. Plug the battery pack into the charger.
3. Red light indicates the battery is charging.
4. Battery takes 8 hrs to completely charge.

NOTE: LEAVING BATTERY UNATTENDED WHILE CHARGING MAY RESULT IN FIRE AND DAMAGE/INJURY. NEVER LEAVE UNATTENDED WHILE CHARGING. IF BATTERY GETS "HOT", UNPLUG AND LET COOL. It's normal for the battery pack to get warm, but it should never get hot!

RECEIVER BATTERY



Not all vehicles have rechargeable receiver packs, but those that do:

1. Plug the charger into a 110v wall receptacle.
2. Plug the battery pack into the charger.
3. Red light indicates the battery is charging.

NOTE: LEAVING BATTERY UNATTENDED WHILE CHARGING MAY RESULT IN FIRE AND DAMAGE/INJURY. NEVER LEAVE UNATTENDED WHILE CHARGING. IF BATTERY GETS "HOT", UNPLUG AND LET COOL. It's normal for the battery pack to get warm, but it should never get hot!

Understanding battery packs

We will go over three different types of battery packs in this section. NiCd, NiMH, and LiPo. Although these three types of batteries have their differences, they also have some things in common. Such as, needing to be charged with a charger designed to charge that specific type of battery. Below are some terms used when talking about batteries.

What is cell count?

This is the number of battery cells used to make a battery pack. The more cells a battery pack contains, the higher the overall pack voltage.

Summary: The higher the cell count, the more voltage a pack has which causes the vehicle to go faster.

mAh rating?

MAh stands for Milliamp-hour and is used to rate a batteries capacity. The higher the mAh rating, the more capacity a battery can hold allowing longer run times.

It is easiest to think in terms of amp hours (Ah) instead of milliamp-hours (mAh). To get this figure, divide the mAh rating by 1000. If you have a battery rated at 3000 mAh, it is equivalent to a 3 Ah rating. Battery companies use milliamp-hours because it looks more impressive than amp-hours do. A battery rated at 3000 mAh = 3 Ah. That means if this battery was being discharged at a constant 1 amp, it would last for 3 hours before completely discharging, hence 3 amp-hours.

Summary: The higher the mAh rating, the longer the run times.

C rating?

The C rating is basically the capacity at which a battery can safely discharge without damaging it's cells. C ratings are multiplied by the pack's Ah to give you the safe amp discharge rate of a battery. For example: A 3000mAh , 20C pack will safely discharge at 60 amps.

3000 mAh = 3 Ah. 3 Ah x 20C = 60 amps.

Summary: The higher the C-rating, the higher the ESC & motor amp draw can be used.

NiCd

NiCd stands for Nickel-cadmium. NiCd batteries were used in RC for a long time. They were the first of the three to be developed. NiCd batteries are similar to alkaline batteries, but NiCd batteries can be recharged. A NiCd battery can be discharged at high rates without damage but they are limited in terms of capacity. NiCd packs were the standard for toy department RC cars.

NiMH

NiMH stands for Nickel-metal hydride. NiMH batteries have larger capacity capabilities than NiCd batteries but they tend to self discharge quicker. While a NiCd would be preferred in a remote, the NiMH batteries high capacity makes it a great choice for RC vehicles.

LiPo

LiPo stands for Lithium-ion polymer. LiPo batteries are a completely different chemistry than both NiCd and NiMH batteries. LiPo batteries don't require pressure as do NiCd and NiMH which allows them to be constructed without the same metal casings the other cells use. LiPo batteries are superior in performance but require more care when being used. LiPo batteries must be charged with a LiPo specific charger and must be used with a voltage cut off device. If a LiPo battery is completely discharged it will not be usable again. Many of the brushless vehicles come with a LiPo ready ESC which has a built in voltage cutoff for that reason. Most brushless systems work best with LiPo batteries because of their large mAh ratings and lighter weight.

Battery comparison chart

	Nicd	NiMH	LiPo
Nominal Cell Voltage	1.2v per cell	1.2v per cell	3.7v per cell
Typical sizes used in RC	6 cell = 7.2 volts 7 cell = 8.4 volts	6 cell = 7.2 volts 7 cell = 8.4 volts	2S = 7.4 volts, 8.4v max. 3S =11.1 volts, 12.6v max. 4S =14.8 volts, 16.8v max.
Capacity rating	Low	High	Very high
Advantages	<ul style="list-style-type: none"> • Handles fast discharge rates because of low internal resistance • Many chargers can charge NiCd batteries 	<ul style="list-style-type: none"> • High discharge ratings • Do not form memory from not discharging 	<ul style="list-style-type: none"> • Very high capacity ratings • Light weight • An even discharge rate through out charge
Disadvantages	<ul style="list-style-type: none"> • Must be discharged before recharging or cells will form a memory which will prevent the battery from completely discharging and can shorten the life of the battery • Can get hot during charging which damages the cells 	<ul style="list-style-type: none"> • Higher self discharge rate than the other battery types when left unused 	<ul style="list-style-type: none"> • Will be damaged if over discharged • Could explode and catch fire if over charged • Cells need to be balanced • Must use an ESC with a voltage cut-off designed for LiPo batteries
Self discharge	Low self discharge	High self discharge	Low initial self discharge
Cautions	<ul style="list-style-type: none"> • Best if completely discharged • Monitor heat during charging 	<ul style="list-style-type: none"> • Best if not completely discharged • Must used NiMH rated charger 	<ul style="list-style-type: none"> • Do not over discharge • Do not over charge • Use a protective battery bag (sold at RC stores) when charging • Must have LiPo voltage cut off on the ESC to use these batteries. • Must have LiPo specific charger

Electric motors

There are two types of electric motors used in RC vehicles, brushed and brushless. Redcat Racing offers vehicles with brushed motors as well as vehicles with brushless motors. In this section we will compare the two.

Brushed motors

Brushed motors use magnets mounted to the inside walls of the motor can. The center shaft, called an armature, contains wire coils used to create positive and negative charges. In order for these coils to work, they must have power supplied to them. Brushed motors use brushes to transfer power to the center shaft through the commutator, located toward the top of the shaft. A typical motor uses two brushes as seen to the right. These brushes must keep constant contact to the commutator in order to charge the coils and keep the motor running.

As you can imagine, lots of heat and friction are created between the brushes and commutator. Keeping this part of the motor clean is important to having a good running motor. Motor cleaning sprays are sold at hobby stores and come in easy to use spray cans. Spray the end of the motor that contains the brushes with motor spray every couple of runs to keep it working properly. Thin bearing oil can be used to lubricate the bearings or bushings after cleaning.

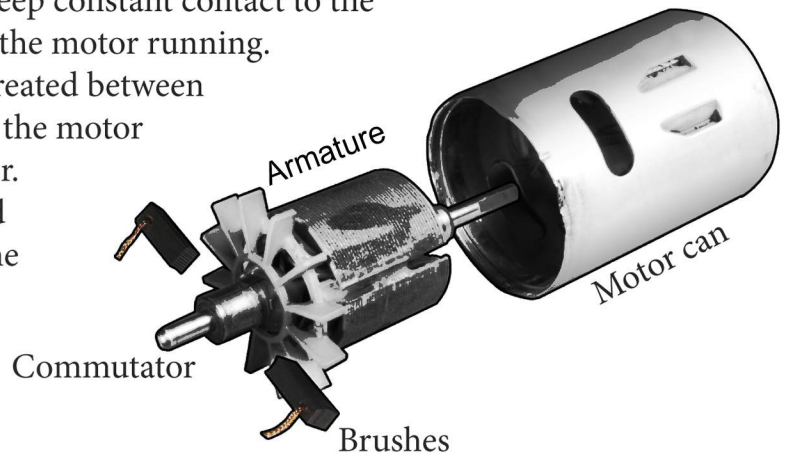

Brushless motors





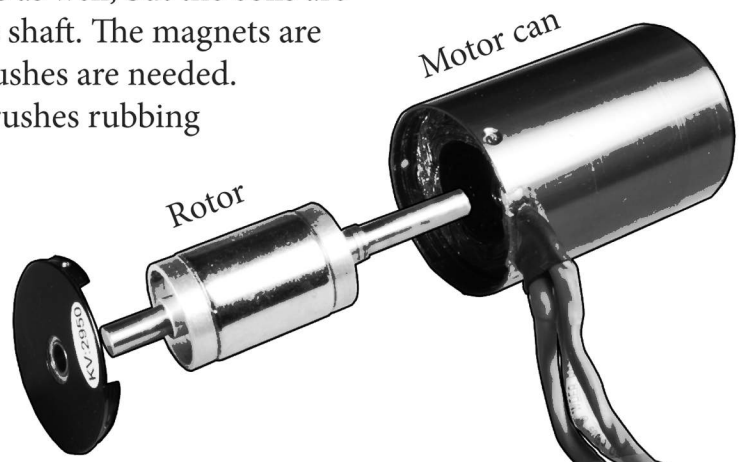

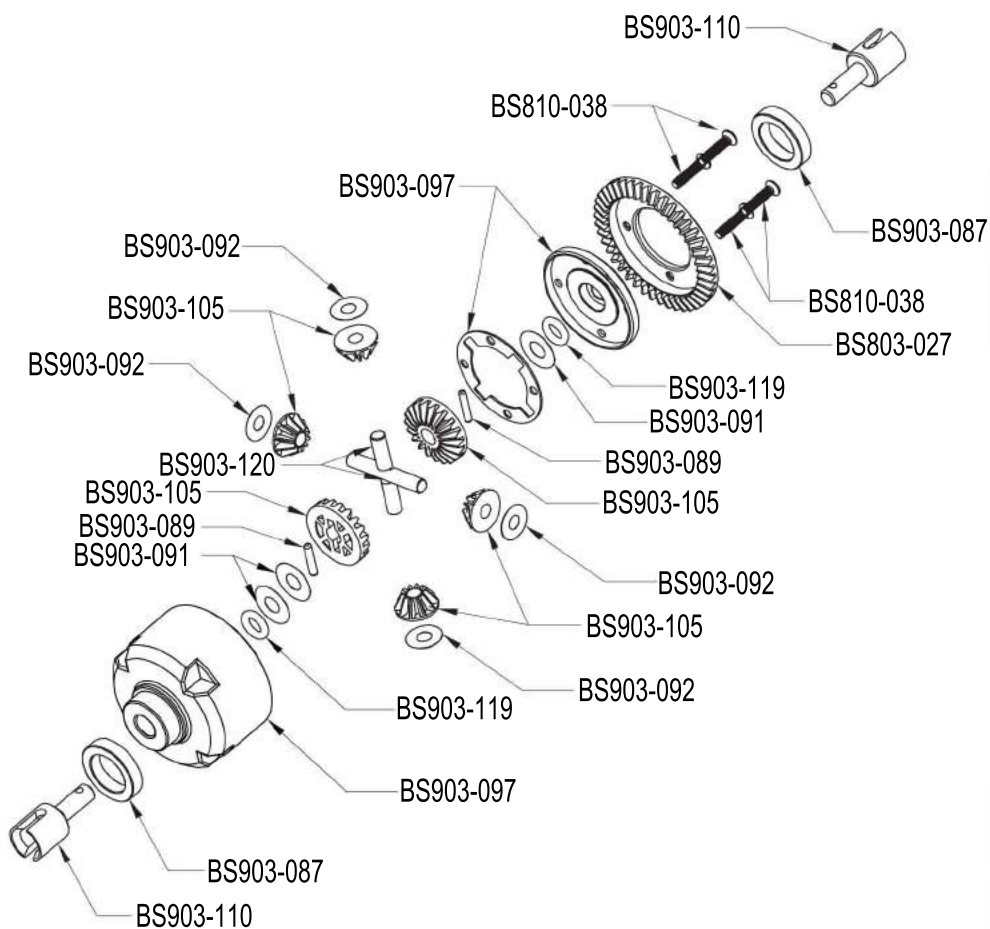

Brushless motors need an electrical supply to the coils as well, but the coils are mounted to the inside of the motor can instead of the shaft. The magnets are mounted to the center shaft, called a rotor, and no brushes are needed.

The lack of friction and electrical arc caused by the brushes rubbing the commutator allow brushless motors to run more efficiently than brushed motors. This means more power and longer run times. Although brushless motors are efficient, they still create heat and over heating any electric motor can cause failure.









BS803-026 Diff Gear box unit

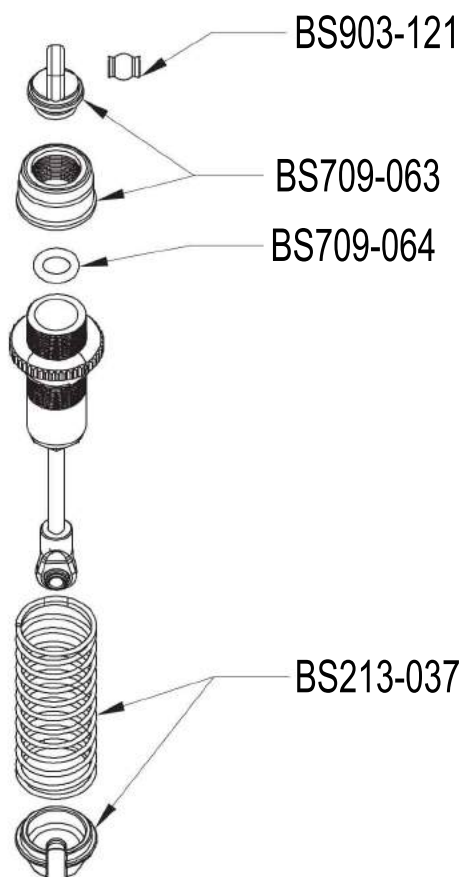

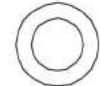
BS903-110	Joint B		-----	1
BS903-087	Ball Bearing(12*18*4)		-----	2
BS810-038	B head hex fine pitch screws HM2.5*12		-----	12
BS903-119	O ring 5*9*2		-----	12
BS903-091	Washer A(5.2*10*0.2)		-----	12
BS903-092	Washer B(4.2*8*0.2)		-----	12
BS903-089	Pin(2*9.8)		-----	12
BS903-120	Diff Gear Shaft (4*26.2)		-----	6

BS213-001 Shock Unit

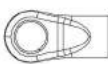

BS709-059	Spacer bush 3.6*5.9*1		-----	4
BS709-059	Shock Low Cylinders		-----	4
BS709-060	O Ring 6.5*3.5*1.5		-----	12
BS709-061	O Ring 5*8*1.5		-----	12
BS709-062	Shock Ball end		-----	6
BS903-121	Shock ball head		-----	12
BS709-064	O Ring 6*10*2		-----	12

BLACKOUT XTE PRO EXPLODED VIEW

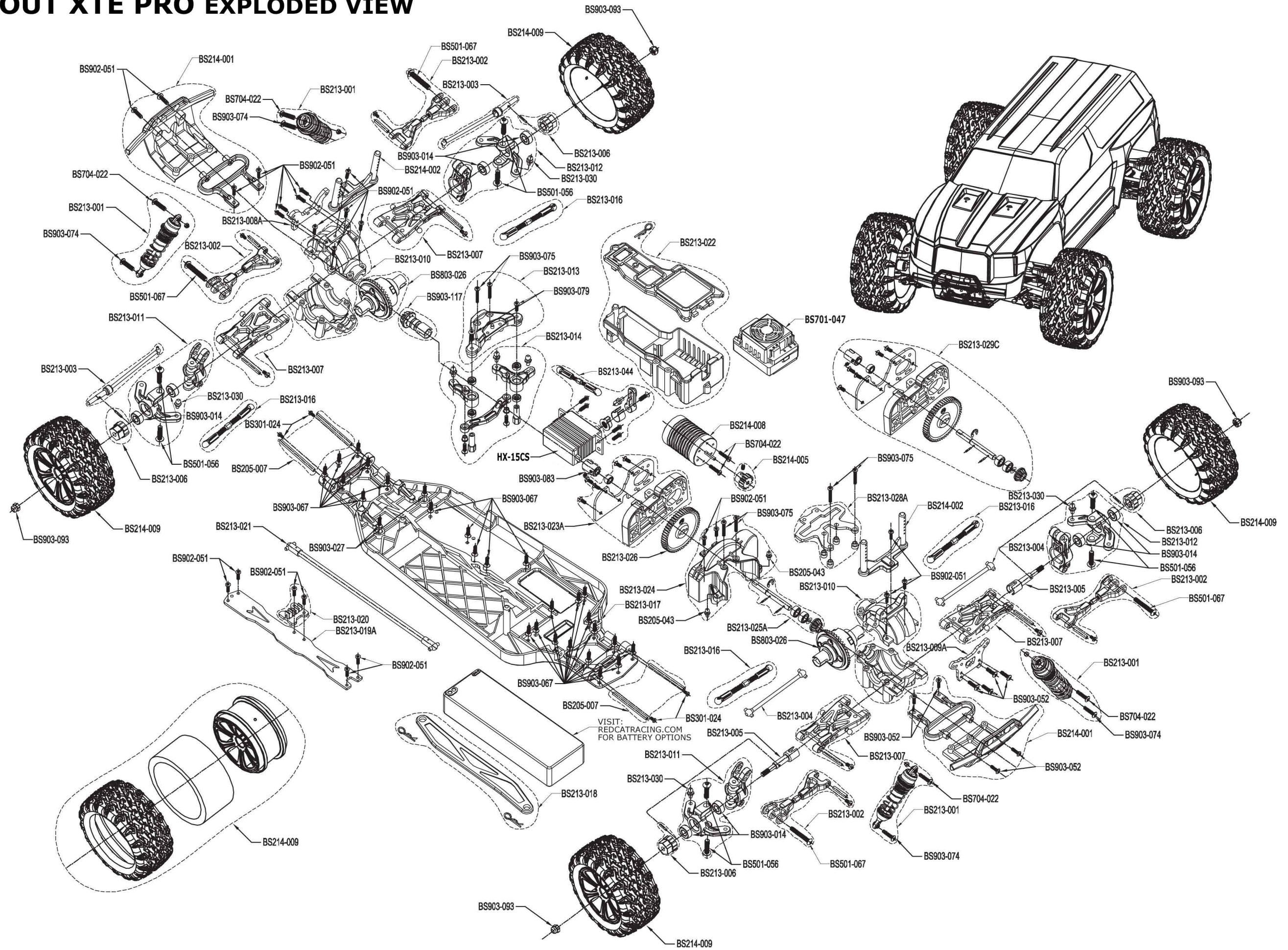

BS213-029A Spur Gear Unit (steel)

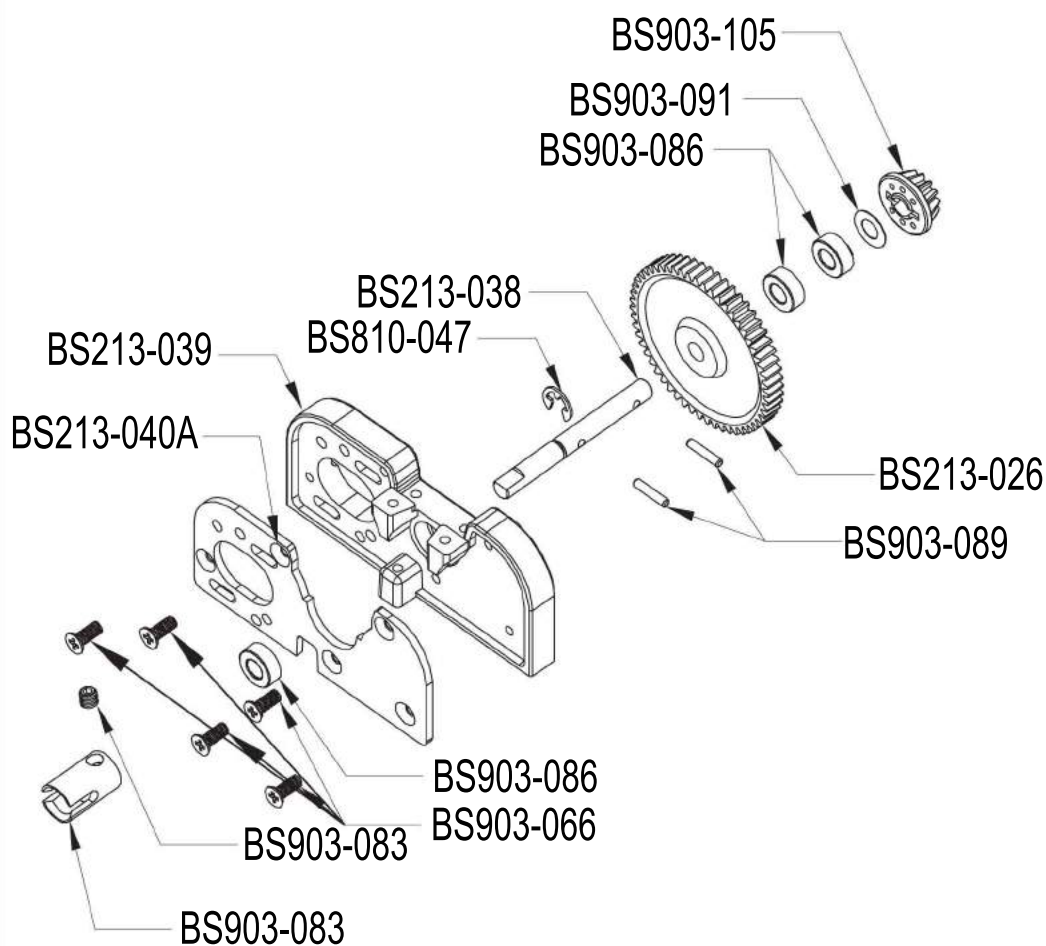

BS903-091	Washer A (5.2*10*0.2)	-----	12
BS903-086	Ball Bearing 5*10*4	-----	2
BS903-089	Pin 2*9.8	-----	12
BS810-047	E Clip	-----	12
BS213-038	Gear shaft	-----	1
BS903-066	Flat Cross Screw(TPF3*8)	-----	12
BS903-083	Joint D	-----	1

BS213-014 Steering System Unit

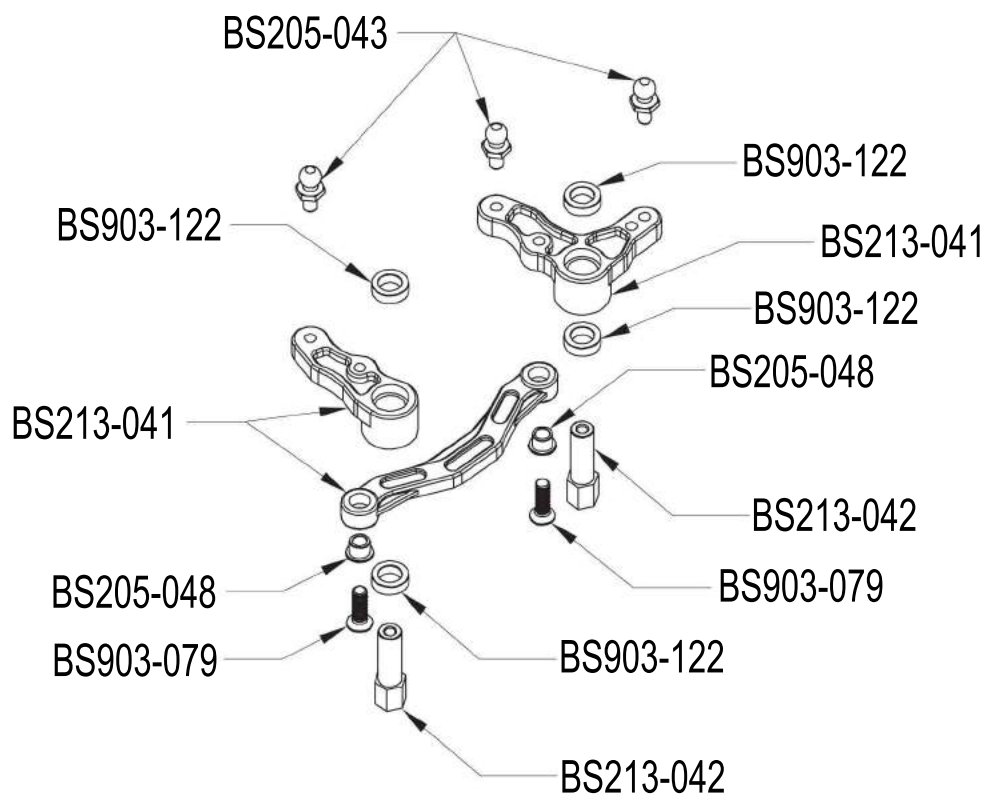

BS205-043	Ball head screw 4.8*12.3	-----	6
BS903-122	Copper bush 5.1*8*2.5	-----	12
BS205-048	Spacer bush 3.05*3.7	-----	12
BS903-079	B-Head Cross Screw(BM3*10)	-----	12
BS213-039	Steering Axis (5*20.9)	-----	2



BS213-001 Shock Unit 2pcs

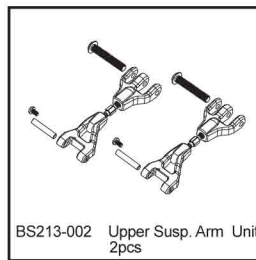

BS213-002 Upper Susp. Arm Unit 2pcs

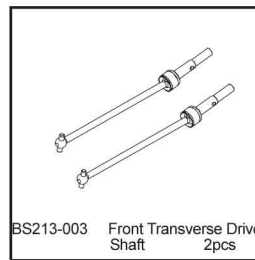

BS213-003 Front Transverse Drive Shaft 2pcs

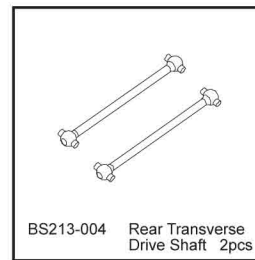

BS213-004 Rear Transverse Drive Shaft 2pcs

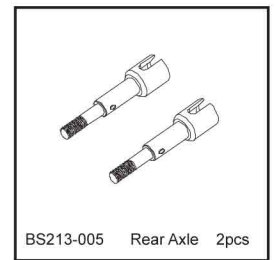

BS213-005 Rear Axle 2pcs

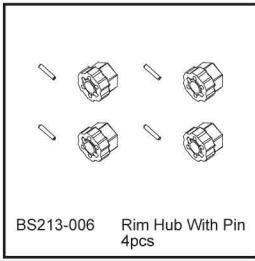

BS213-006 Rim Hub With Pin 4pcs

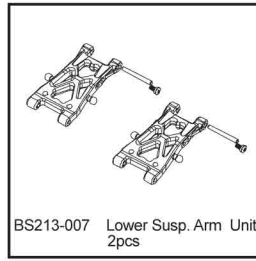

BS213-007 Lower Susp. Arm Unit 2pcs

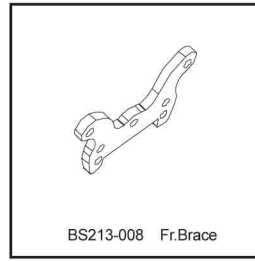

BS213-008 Fr.Brace

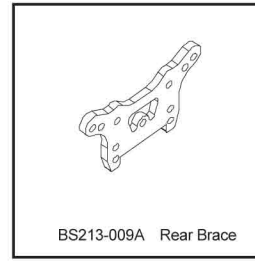

BS213-009A Rear Brace

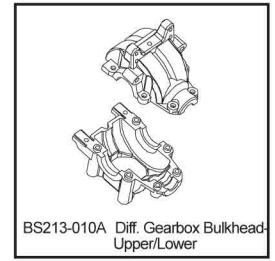

BS213-010A Diff. Gearbox Bulkhead Upper/Lower

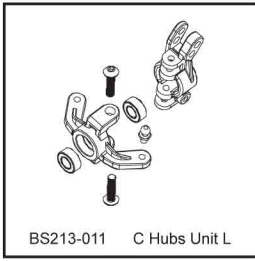

BS213-011 C Hubs Unit L

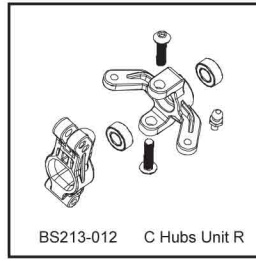

BS213-012 C Hubs Unit R

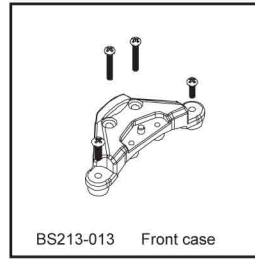

BS213-013 Front case

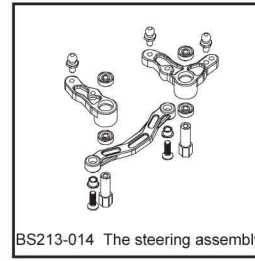

BS213-014 The steering assembly



BS213-016 Steering Link 4pcs

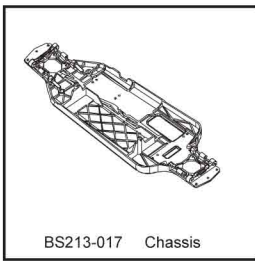

BS213-017 Chassis

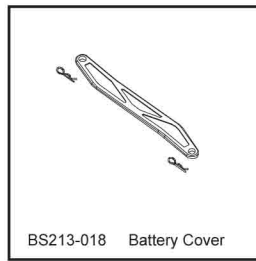

BS213-018 Battery Cover

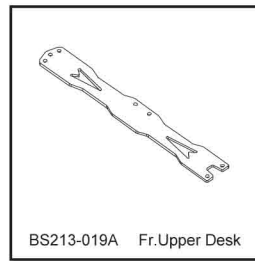

BS213-019A Fr.Upper Desk

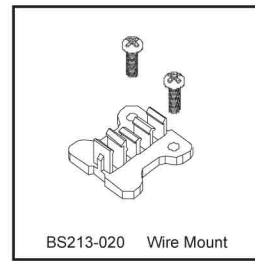

BS213-020 Wire Mount

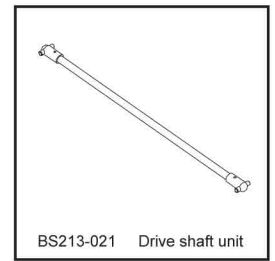

BS213-021 Drive shaft unit

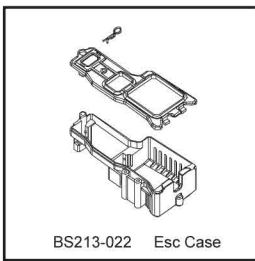

BS213-022 Esc Case

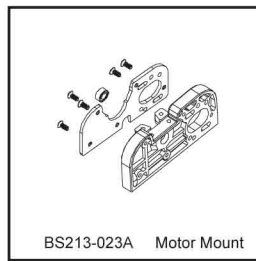

BS213-023A Motor Mount

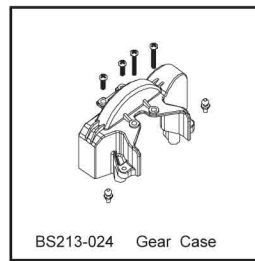

BS213-024 Gear Case



BS213-026 Spur Gear 55T

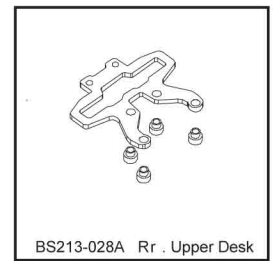

BS213-028A Rr . Upper Desk

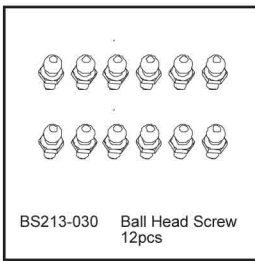

BS213-030 Ball Head Screw 12pcs

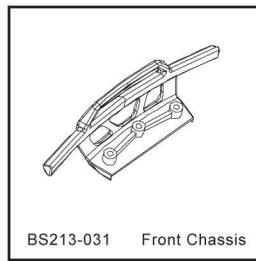

BS213-031 Front Chassis

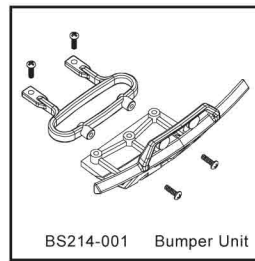

BS214-001 Bumper Unit

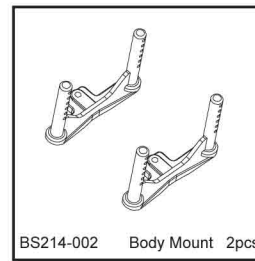

BS214-002 Body Mount 2pcs

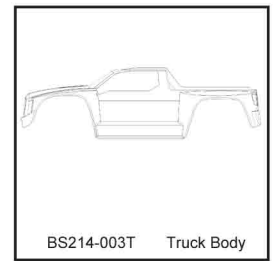

BS214-003T Truck Body

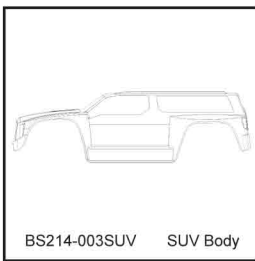

BS214-003SUV SUV Body

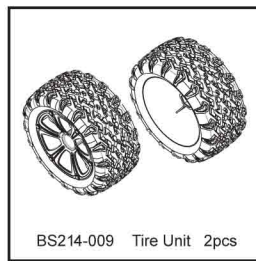

BS214-009 Tire Unit 2pcs

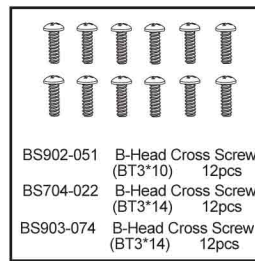

BS902-051 B-Head Cross Screw (BT3*10) 12pcs

BS704-022 B-Head Cross Screw (BT3*14) 12pcs

BS903-074 B-Head Cross Screw (BT3*14) 12pcs

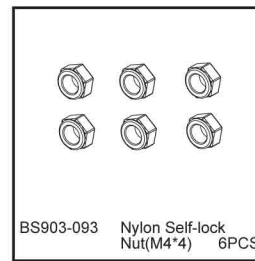

BS903-093 Nylon Self-lock Nut(M4*4) 6PCS

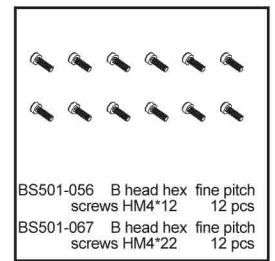

BS501-056 B head hex fine pitch screws HM4*12 12 pcs

BS501-067 B head hex fine pitch screws HM4*22 12 pcs

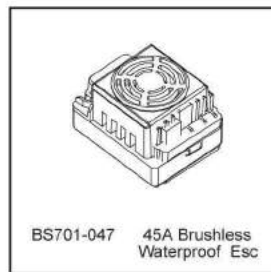
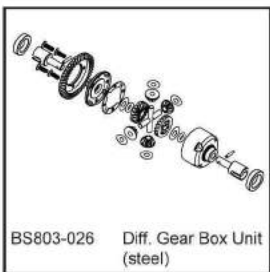
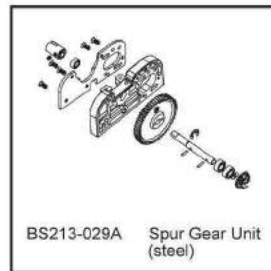
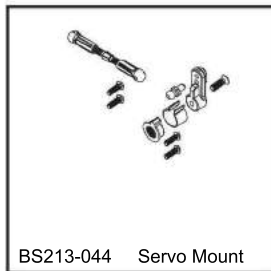
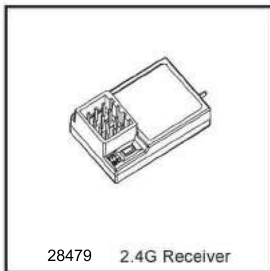
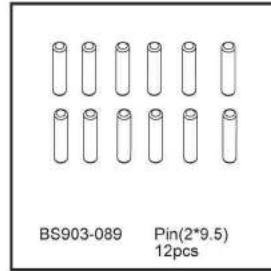
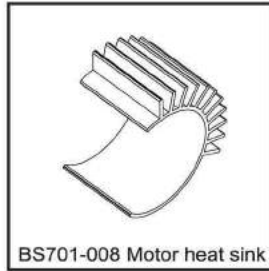
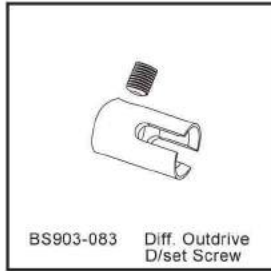
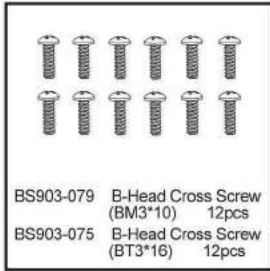
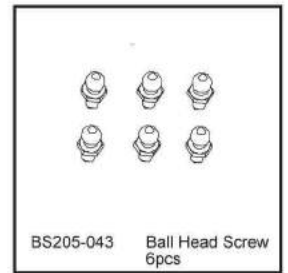
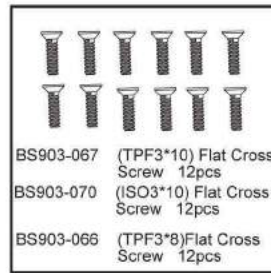
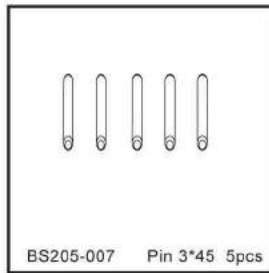
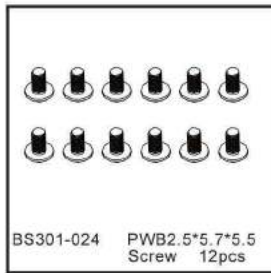
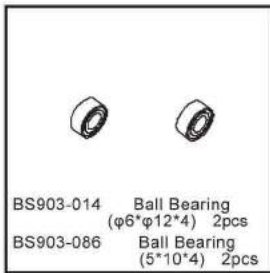

Driving Tips

Here are some tips to help improve your driving skills.

Perspective:

The single most difficult aspect of driving RC vehicles is perspective. Perspective involves your relation to the vehicle. Are you behind the vehicle, in front of the vehicle, or beside it?

Driving an RC vehicle while standing behind it is like driving a full size car or go-cart. When you turn left, it goes to the left and when you turn right, it goes to the right. Simple.

What if the vehicle is coming toward you? When to turn the wheel to the left, will it go toward your left? No! Because the vehicle is coming toward you, the controls seem reversed. The controller doesn't actually change, it just seems like it does because of perspective.

Always imagine yourself sitting inside the vehicle, not standing outside with a remote. Imagine you are driving and the wheel on the remote is the actual steering wheel inside the car. Keeping this mind set will help you make the correct steering decisions no matter which direction the RC vehicle is pointed.

Controlling Steering and throttle input

The steering and throttle inputs are both proportional. This means slightly pulling the trigger will make the RC vehicle move slowly. Pulling the trigger all the way back will cause the RC vehicle to go fast. The same applies to the steering.

The most common mistake with new RC enthusiasts is over correction. Over correction is when a slight amount of steering or throttle is needed and full throttle or steering is applied causing "crazy driving".

It's a good time to learn how to control your movements. This may sound silly, but nerves and adrenaline have a lot to do with over correction. It is sometimes difficult to control our movements when we are excessively excited and I promise you, when this vehicle blasts across your yard and the grass starts flying, you will get excited.

As you become more familiar with your RC vehicle, you will tend to relax a little more making it easier to concentrate on small control inputs instead of great big ones.

Look where your going

While controlling a vehicle going 30 mph it's important to look where it's going instead of where it's been. Looking a good five-to-fifteen feet in front of the vehicle will give you time to react to uncertain obstacles. It also prevents trees from jumping out in front of you.

Driving with minimal braking:

Let me clarify what I am talking about. Do not disable the brakes at any time on your Redcat Racing RC vehicle. I am talking about planning ahead and looking where you are going.

Find a large field or empty lot you have permission to be on. Set out some small cones or plastic cups to mark the corners of an oval. Drive around your newly created test track and see how it goes.

Now drive around the same track but this time, look at the corner before you get there. Let off the throttle before you get to the corner and plan how you will get around it. Using this technique, try to make it around the whole track without using the brakes. Let the vehicle coast around each corner and apply throttle as you exit. Continue this over and over, increasing speed with each lap. If it gets too exciting in the corner, let off the throttle sooner. This will teach you to look ahead eliminating surprises. Use caution! If you think you might hit something, hit the brakes instead.

Advanced driving tips

As you become comfortable driving your Redcat Racing RC vehicle, you may want to drive smoother and with more precision so you can go faster. Here are a few driving tips that are sure to add some excitement.

Drifting:

Driving on loose surfaces like dirt or gravel can be fun, but how do you keep from spinning out?

Counter steering is the answer to that question. Here is a rule of thumb to go by. Always keep the front tires pointed in the direction you want the car to go. This is true regardless which direction the vehicle itself is pointed.

Here is an example:

Let's say you are driving in loose dirt. You are traveling at full speed and you want to make a left hand turn while maintaining most of your speed. You turn the wheel left spinning the vehicle 360 degrees resulting in a complete loss of speed.

Try this! Get the RC up to full speed again, only this time, turn left and when the vehicle starts to spin, turn right keeping the front tires pointed where you want the car to go. When done correctly, the vehicle will enter into a slide or "drift" allowing you to turn while maintaining most of your speed. Practice this many times in both directions and you'll be drifting like a pro.

Jumping:

When done correctly, jumping is by far the most impressive maneuver done with RC vehicles. All RC's can go up, but how they land determines whether it was a success or a mess. Anyone can hit a jump at full speed, I'm going to teach you how to land on all four tires.

The wheels on an RC vehicle act as gyroscopes. All this really means is, you can drive the vehicle while it's in the air. The amount of throttle or brake applied while in mid flight will control whether the nose is up or down. Applying throttle will raise the nose and applying brake will lower the nose.

This is good to know if you hit a jump and your vehicle's nose is pointed at the ground. Hit the gas! Hitting the gas will raise the nose to help level out the landing. The amount of throttle used is in direct relation to the amount of correction needed.

This is where it gets complicated. Adding steering input in conjunction with throttle inputs will cause a whole new outcome.

Let's say you are in mid flight, your left front tire is closest to the ground, and you want to level the vehicle out. In this case you would steer left and apply throttle. This will raise the left front tire. Applying too much throttle will raise the left front tire too high.

Here is a good rule of thumb. Steer into the front corner of the vehicle you want to correct and apply the appropriate trigger response. Remember, applying throttle raises the nose and applying the brake lowers it.

This will take much practice so be sure to have some spare parts on hand. Bad landings can do lots of damage.

TROUBLE SHOOTING ELECTRIC

Vehicle steers left/right but won't drive forward/backward:
Battery is too low and needs to be charged.

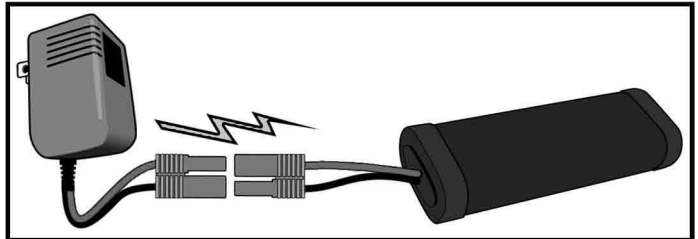
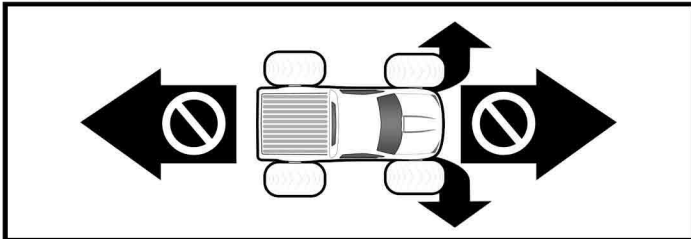

Vehicle drives forward/backward but won't steer left/right:
Steering dual rate is set too low. Turn the steering dual rate knob counterclockwise.

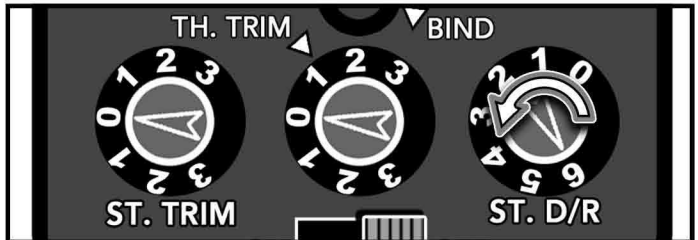
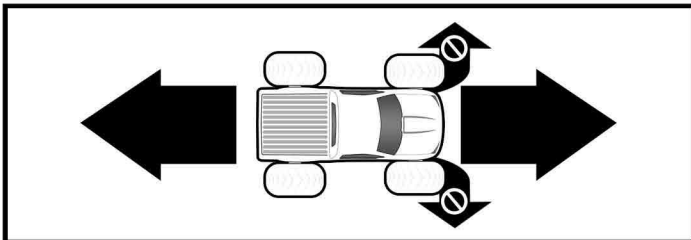

Vehicle drives fast, slow, fast, slow (LIPOs only):
ESCs low voltage cutoff is warning you that the LIPO battery needs to be recharged.
Turn off the vehicle immediately and disconnect the LIPO battery to avoid over discharge.
Recharge the LIPO battery before driving your R/C vehicle again.

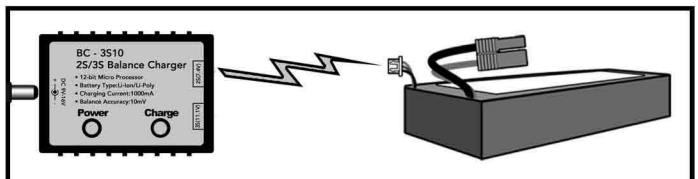
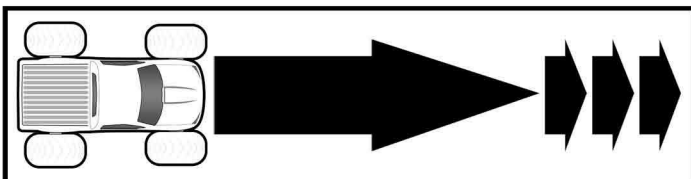

Trouble Shooting Guide

SYMPTOMS	PROBLEM	CORRECTION
Vehicle won't steer or move	<ul style="list-style-type: none"> • Transmitter not turned on • Transmitter batteries are dead • ESC not turned on • Battery packs not charged or plugged in 	<ul style="list-style-type: none"> • Turn on transmitter • Replace transmitter batteries • Turn on ESC • Charge battery packs and ensure proper connection
Vehicle steers but won't move	<ul style="list-style-type: none"> • Battery pack not charged • Motor wires damaged or unplugged • ESC needs to be reset 	<ul style="list-style-type: none"> • Charge battery packs • Plug in or fix motor wires. Use electrical tape to cover bare metal • Follow ESC manual to reset
Grinding sound	<ul style="list-style-type: none"> • Screws on rim rubbing linkage • Gears loose or worn 	<ul style="list-style-type: none"> • Set steering rate lower on transmitter • Tighten or replace gears
Motor spins but truck won't move	<ul style="list-style-type: none"> • Hex inside wheel is rounded out • Axle damaged or missing 	<ul style="list-style-type: none"> • Replace rim • Reinstall axle, replace if damaged
Trucks bounces or wobbles while driving fast	<ul style="list-style-type: none"> • Dirt stuck inside the rims • Bent axle or drive shaft 	<ul style="list-style-type: none"> • Clean rims • Replace axle or drive shaft
Truck turns to the side automatically	<ul style="list-style-type: none"> • Steering trim on transmitter needs to be adjusted • Servo saver too loose • Front wheels have too much toe-out • Steering servo horn needs to be re-aligned or replaced • Gears in servo are stripped 	<ul style="list-style-type: none"> • Adjust steering trim • Tighten servo saver • Adjust linkage to align front wheel parallel (0° toe) • Check servo horn by removing and replace if worn • Replace gears or servo
Makes clicking noise while steering	<ul style="list-style-type: none"> • Screws on rim rubbing linkage • Gears in servo are stripped • Servo horn is stripped 	<ul style="list-style-type: none"> • Set steering rate lower on transmitter • Replace servo horn
Sluggish steering	<ul style="list-style-type: none"> • Servo saver too loose 	<ul style="list-style-type: none"> • Tighten servo saver
Loss of control	<ul style="list-style-type: none"> • Transmitter batteries too low 	<ul style="list-style-type: none"> • Replace transmitter batteries
Battery pack won't charge	<ul style="list-style-type: none"> • Loose connection • Bad battery pack • Using wrong charger 	<ul style="list-style-type: none"> • Ensure proper connection • Replace battery pack • Use LIPO specific charger
Truck moves with no throttle input	<ul style="list-style-type: none"> • Throttle trim on transmitter is not set properly 	<ul style="list-style-type: none"> • Adjust throttle trim so vehicle does not move while throttle is in neutral
Suspension is bouncy and lower suspension arm is wet	<ul style="list-style-type: none"> • Shock leaking oil 	<ul style="list-style-type: none"> • Remove shock, refill with oil, and replace cap tightly. • Tighten lower shock cap

Maintaining your Redcat Racing vehicle

There is much fun to be had running RC vehicles. To ensure that fun continues throughout the years, here are some maintenance tips to follow.

Chassis maintenance:

Many substances such as dirt, grass, & grime can find its way onto your RC chassis. It's a good idea to clean this off after each days use. There are many ways to clean an RC vehicle. Here are a few examples.

1. One of the most effective ways to clean the chassis is with a used tooth brush, old paint brush, and rag. These three tools work well for removing dirt and debris.
2. Pay close attention to areas with moving parts such as suspension components, steering components, and drive train. It is important to get these areas clean to help prevent wear.
3. Though running your vehicle through water is never recommended, moisture may still make its way into the vehicles bearings. Here are some tips on drying, cleaning, and oiling the bearings.

Your Redcat Racing vehicle may have bearings in various locations like wheel hubs, steering linkages, gear supports, and drive shaft supports. First you must have access to all the bearings. Remove all four wheels and any other parts blocking bearing access.

- Spray the bearings with a water displacer such as WD40 or Wire Dryer. This will flush out moisture, dirt, and grime.
 - After a good spraying with a water displacer, the bearing will be left dry and in need of oil. Use a light bearing oil found at the hobby shop or auto parts store. *This step is important* Failing to re-oil the bearing will cause them to wear prematurely and replacements will be necessary. A few drops of oil per bearing should be fine. Spin the bearing to work the oil into the inner race.
4. Check all screws and moving parts
 - It's a good idea to quickly go over the entire vehicle after each run to ensure all screws remain tight and there isn't any excess slop in the moving parts.
 - Thread lock should be used on any screws that fasten into metal parts, especially the motor mount.
 5. Checking for cracks and excess wear is also a good way to save yourself from headaches down the road.

Maintaining your Redcat Racing vehicle

Electronics:

Be sure to check your electronics after each use. The electronics are the life line of the vehicle and if they aren't working properly, a crash is almost certain.

- Periodically range check your radio system to ensure proper operation.
- Check batteries regularly. It is important to have fresh batteries in the transmitter.
- Check the antenna on both the receiver and the transmitter. Make sure there are no cuts or breaks in the receiver antenna. This will cause glitches and possible signal loss.
- Using the transmitter, check the steering servo by turning the wheel back and forth. Check that it is operating smoothly and no clicking noises can be heard.
- Make sure all electronics stay dry. Water can short out the circuit boards inside the electronics causing failure.
- Brushed motors should be sprayed with electric motor spray found at your local hobby shop. This will prolong the motor's life by keeping the commutator and brushes clean. Remember to re-oil the bearings or bushings with a light bearing oil. Brushless motors do not need cleaning.
- The electronic speed controller should be inspected after each use. Make sure all connections are tight and no wires are in harm's way. Check the fan (if included) on the ESC for any debris. The fan is an important component in keeping the ESC cool. Make sure the ESC stays dry and never store with a battery pack plugged in.

SETUP TIPS

Redcat Racing cars, trucks, and buggies offer many tuning options to help you achieve the exact feel you like in a vehicle. These tuning options include shock position, ride height, camber, toe in or out, shock stiffness, and over all suspension geometry.

SHOCK POSITION:

Shock position plays a big role in how your vehicle handles bumps as well as turning stability. The effects of shock position effect the area of the vehicle you change. For instance, if you change the front shock positions, it will effect the traction and stiffness of the front tires.

FRONT SHOCK POSITION:

POSITION: TOP=1 & BOTTOM=3:

The straighter up and down the shock is, the stiffer it will feel. This may also decrease bump handling stability as well as decrease traction. The benefit of this position in increased steering response.

POSITION: TOP=3 & BOTTOM=1:

Shocks in a more leaned position will give a softer feel. This increases bump stability and front traction however, it decreases steering response.

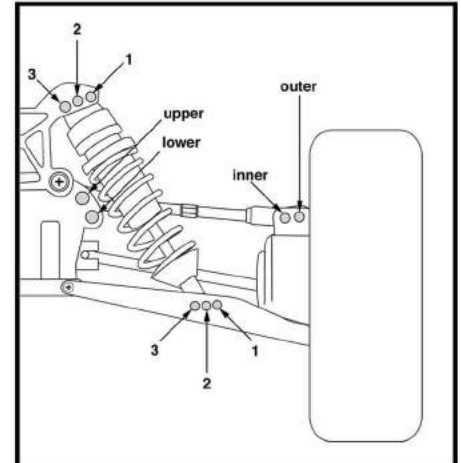

REAR SHOCK POSITION:

POSITION: TOP=1 & BOTTOM=3:

The straighter up and down the rear shocks are, the stiffer the feel. This decreases rear traction which increases steering, but gives less stability over bumps.

POSITION: TOP=3 & BOTTOM=1:

Leaning the rear shocks in decreases steering by providing more rear traction and increases bump stability.

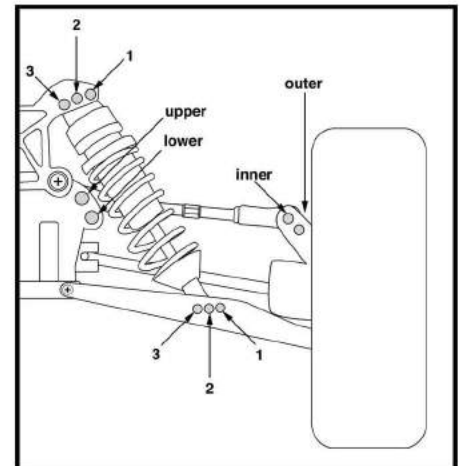

RIDE HEIGHT:

Adjust ride height by moving the top spring collar up or down on the shock body. Increasing ride height allows you to drive over larger obstacles but also raises the vehicle's center over gravity (C.O.G.). A higher (C.O.G.) means less stability. Decreasing ride height increases stability but decreases the size of the obstacles you can maneuver over.

SHOCK OIL:

Heavier weight shock oil (bigger number) will provide more dampening and slow down the speed at which the shock travels. This will reduce chassis roll for more stability. Lighter weight shock oil (smaller number) will offer less dampening allowing the shock to recover quicker. This is better for rough terrain but offers less high speed stability from increases chassis roll.

UPPER LINK ADJUSTMENTS:

Adjusting the upper link effects the vehicle's "roll center". Adjusting "roll center" will effect the way the chassis rolls at its center of gravity.

There are two mounting positions to chose from on the chassis side and hub carrier side of the upper link.

Two things to watch for are upper link length and upper link angle.

UPPER LINK LENGTH:

The longer the upper link, the more the chassis wants to roll in turns. While chassis roll may not seem good, it adds traction in the turns. This is good for a loose track where much traction is needed.

The shorter the upper link, the less the chassis will roll. This is good for a high bite track where stability is needed.

UPPER LINK ANGLE:

The angle of the upper links also effect chassis roll.

PARALLEL UPPER LINK:

When the upper link is parallel (level) to the lower arm, the chassis has a tendency to roll more giving more cornering traction on low grip tracks.

ANGLED UPPER LINK:

You must first understand, when I refer to an angled upper link, I'm referring to the inside of the link angling downward. This will give the vehicle a more stable feel with less overall traction. This is good for high bite tracks where stability is needed.

FRONT OR REAR:

Keep in mind, changes made to the rear effect the rear and changes made to the front effect the front. Both front and rear traction effect the vehicles turn-ability. Less traction in the front will make the vehicle more difficult to steer, but less traction in the rear will make the vehicle steer more easily.

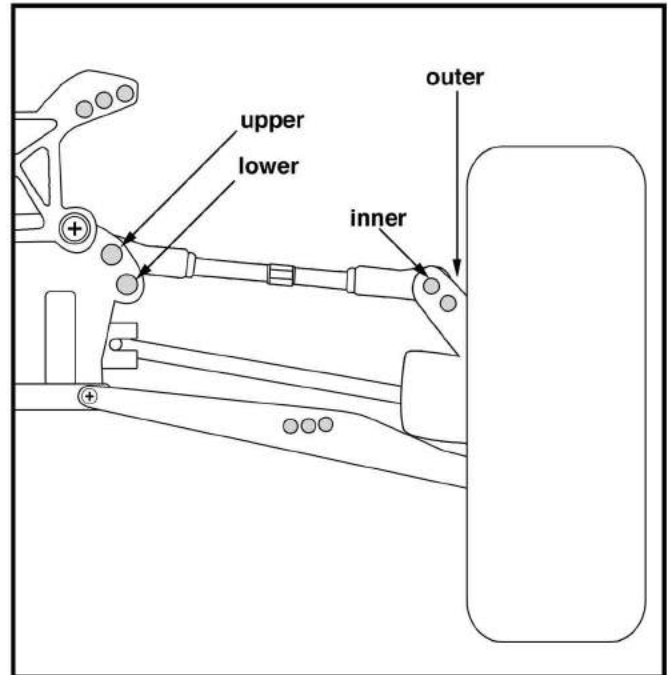

TOE IN & OUT:

Toe in and out refers to whether the front of the tires are angled in or out.

TOE OUT:

Toe out gives less straight line tracking (darty feel) but more steering. 2 degrees of toe out is usually good for the front.

TOE IN:

Toe in gives less steering and more straight line tracking. 0-2 degrees of toe in are usually good for the rear.

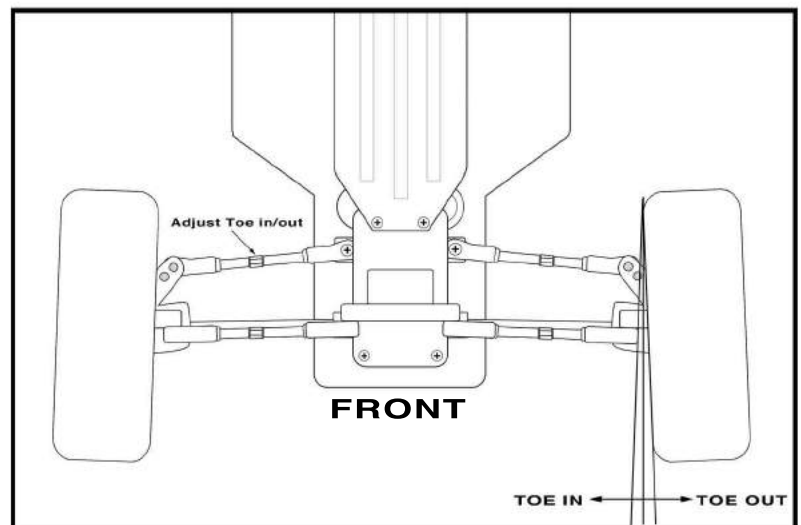

CAMBER:

Camber is the vertical angle at which the tires sit in relation to the ground.

NEGATIVE CAMBER:

Adding little negative camber (1-2 deg.) will lean the tops of the tires inward providing more traction while cornering.

POSITIVE CAMBER:

Adding little positive camber will lean the tops of the tires outward providing much less traction while cornering. Positive camber is usually not used.

NEUTRAL CAMBER:

No camber added will set the tires straight up and down offering the most straight line traction but slightly decreased traction while cornering.

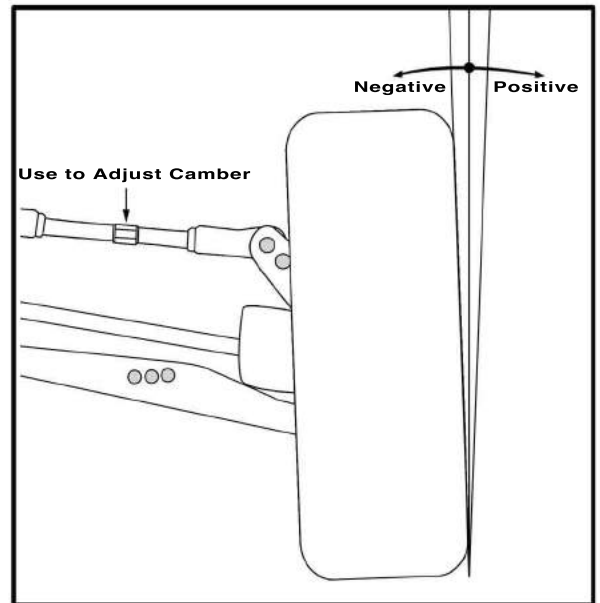

SLIPPER CLUTCH ADJUSTMENTS:

INCREASING SLIP:

The small nut on the end of the slipper clutch (large spur gear next to motor) allows you to tune the vehicles traction to your driving style.

Loosening the nut provides more clutch slip which reduces the amount of wheel spin. Over loosening the slipper clutch will cause the spur gear to slip too much resulting in high levels of heat from friction. This can ruin a gear quickly.

DECREASING SLIP:

Tightening the small slipper nut will reduce gear slippage sending the power to the ground resulting in more wheel spin. The slipper clutch also acts to protect the inner gears from shock failure. This occurs when landing while on full throttle or hitting something while on throttle. Over tightening the slipper clutch will reduce that protection and will not save the inner gears in the spoken circumstances.

SETTING THE SLIPPER:

The slipper should slip slightly (not easily) when rolling the vehicle while holding the spur gear. If it slips easily, it is too loose. If it will not slip at all, it is too tight.

GEARING:

Gearing the vehicle down will provide more initial power and less top speed. Gearing the vehicle up will provide more top speed and less initial power.

GEARING UP:

There are two ways you can rear up for more speed. Increase the size (more teeth) of the pinion gear (small gear attached to the motor) or Decrease the size (less teeth) of the spur gear (large gear on the slipper clutch)

GEARING DOWN:

There are two ways to gear the vehicle down for more power. Decrease the size (less teeth) of the pinion gear (small gear attached to motor) or increase the size (more teeth) of the spur gear (large gear on slipper clutch)

SETTING GEAR MESH

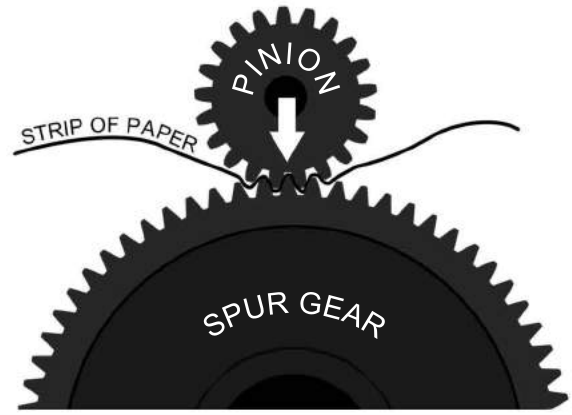
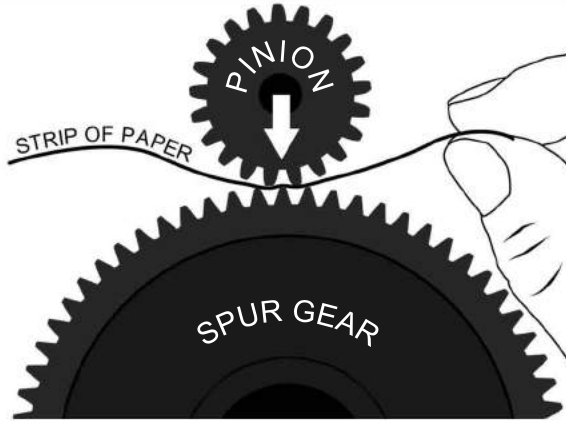

Proper gear mesh is very important. Improperly meshed gears will result in gear and/or engine, motor, ESC, and battery failure.

1. Loosen the motor mount screws, allowing the motor to slide, opening the gap between the pinion and spur gear.
2. Place a strip of paper between the pinion and spur gears.

3. Firmly press the pinion to the spur gear.
4. Ensure blue thread lock is on the motor mounting screws & lightly tighten each screw.
5. Check for movement between the two gears (fig.1) (fig.2) (fig.3) and tighten the motor mount screws completely. Alternate between screws as tightening.
6. Remove paper and check gear mesh. See (fig.1) (fig.2) (fig.3) below.

TESTING GEAR MESH

TOO LOOSE



Gears are too loose.

There is too much movement between the two gears. (fig.1)

RESULT: Stripped gears. Overheated and damaged engine.

GOOD



Gears are spaced correctly.

TEST: Hold the pinion gear completely still. Place a finger nail on the spur gear and try to rock it back and forth. There should be a very small (almost no) amount of movement in the spur gear. (fig.2)

TOO TIGHT



Gears are too tight.

There is no movement between the pinion and spur gear. (fig.3)

RESULT: Overheated and damaged engine, motor, ESC, and/or battery.

Set-up Sheet

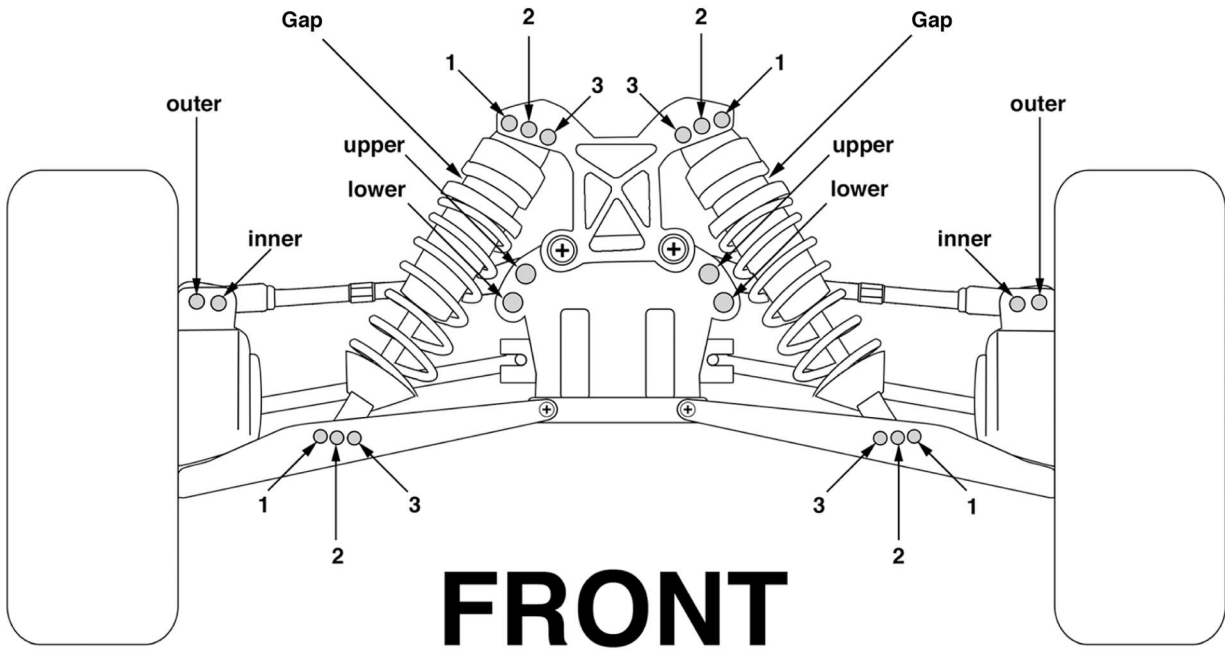

Shock Position:

Top: 1 2 3
 Bottom: 1 2 3

Upper Link Position:

Inside: Upper Lower
 Outside: Inner Outer

Shock oil: _____ wt.

Camber Deg:

Negative: _____ degrees
 Positive: _____ degrees

Spring pre-load "Gap": _____

Toe:

In: _____ degrees
 Out: _____ degrees

Piston inserts: _____ (1, 2, or 3 holes)

Additional notes: _____

Battery:

LiPO: _____ Cell, _____ Mah, _____ C
 NiMH: _____ Cell, _____ Mah _____
 LiFE: _____ Cell, _____ Mah, _____ C

Set-up Sheet

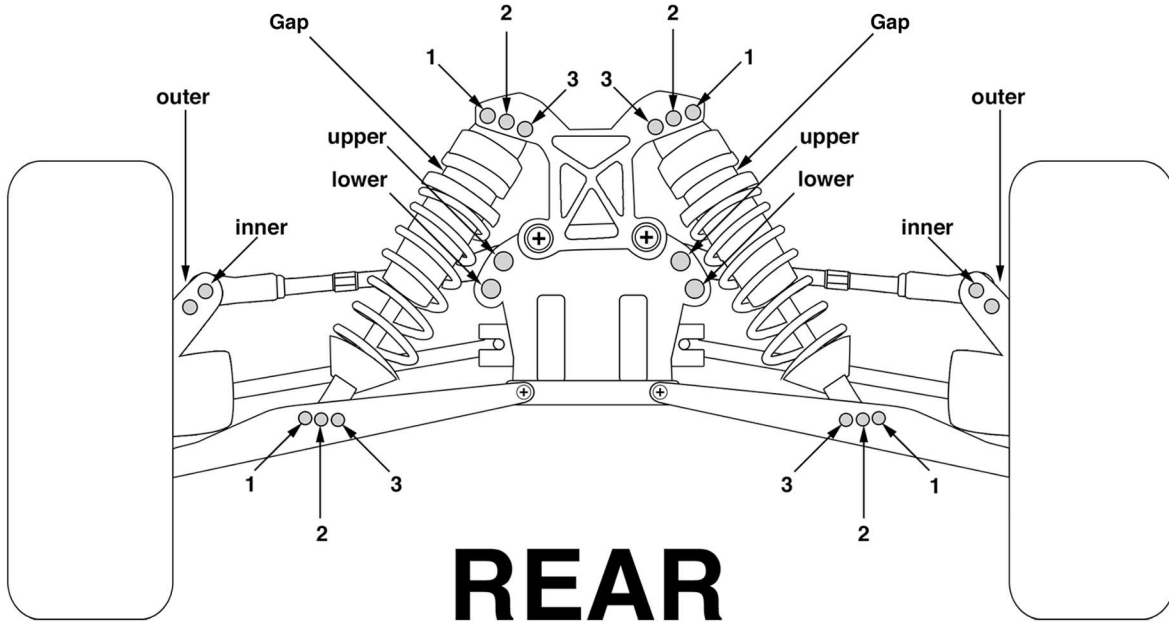

Shock Position:

Top: 1 2 3
 Bottom: 1 2 3

Upper Link Position:

Inside: Upper Lower
 Outside: Inner Outer

Shock oil: _____ wt.

Camber Deg:

Negative: _____ degrees
 Positive: _____ degrees

Spring pre-load "Gap":

Piston inserts: _____ (1, 2, or 3 holes)

Additional notes: _____

Pinion Gear: _____ teeth

Spur Gear: _____ teeth

Spur Gear: metal plastic

Tires: _____
