



dirt rocket
MX350 & MX400



OWNER'S MANUAL

**Read and understand this entire manual before riding!
DO NOT RETURN TO STORE!**

**NOTE: Manual illustrations are for demonstration purposes only.
Illustrations may not reflect exact appearance of actual product.
Specifications subject to change without notice.**

Item Numbers:
Dirt Rocket MX350 15128040
Dirt Rocket MX400 15128030

SAFETY WARNINGS

⚠ WARNING: Riding an electric motorbike can be a hazardous activity. Certain conditions may cause the equipment to fail without fault of the manufacturer. Like other electric products, the Dirt Rocket can and is intended to move, and it is therefore possible to lose control, fall off and/or get into dangerous situations that no amount of care, instruction or expertise can eliminate. If such things occur you can be seriously injured or die, even when using safety equipment and other precautions. **RIDE AT YOUR OWN RISK AND USE COMMON SENSE.**

This manual contains many warnings and cautions concerning the consequences of failing to maintain, inspect or properly use your electric motorbike. Because any incident can result in serious injury or even death, we do not repeat the warning of possible serious injury or death each time such a possibility is mentioned.

APPROPRIATE RIDER USE AND PARENTAL SUPERVISION

This manual contains important safety information. It is your responsibility to review this information and make sure that all riders understand all warnings, cautions, instructions and safety topics and assure that young riders are able to safely and responsibly use this product. Razor USA recommends that you periodically review and reinforce the information in this manual with younger riders, and that you inspect and maintain your children's product to insure their safety.

The recommended rider age of 13 years (MX350/MX400) is only an estimate, and can be affected by the rider's size, weight or skills. Any rider unable to fit comfortably on the Dirt Rocket should not attempt to ride it. **A parent's decision to allow his or her child to ride this product should be based on the child's maturity, skill and ability to follow rules.**

Keep this product away from small children and remember that this product is intended for use only by persons who are, at a minimum, completely comfortable and competent while operating the products.

Do not exceed 140lbs. (63kgs.) total weight on the MX350 and MX400. Rider weight does not necessarily mean a person's size is appropriate to fit or maintain control of the Dirt Rocket.

Do not touch the brakes or electric motor on your electric motor bike when in use as they can become very hot.

Refer to the section on safety for additional warnings.

ACCEPTABLE RIDING PRACTICES AND CONDITIONS

Always check and obey any local laws or regulations which may affect the locations where the Dirt Rocket may be used.

Ride defensively. Watch out for potential objects that could catch your wheel or force you to swerve suddenly or lose control. Be careful to avoid pedestrians, skaters, skateboards, scooters, bikes, children or animals who may enter your path, and respect the rights and property of others.

The Dirt Rocket is meant to be used only in controlled environments free of potential traffic hazards and not on public streets or sidewalks. Do not ride your electric motor bike in any areas where pedestrian or product traffic is present.

Do not activate the speed control on the hand grip unless you are on the electric motor bike and in a safe, outdoor environment suitable for riding.

These bikes were manufactured for performance and durability but are not impervious to damage. Jumping or other aggressive riding can over-stress and damage any product, including the electric motorbike, and the rider assumes all risks associated with high-stress activity.

Be careful and know your limitations. Risk of injury increases as the degree of riding difficulty increases. The rider assumes all risk associated with aggressive riding activities.

Maintain a hold on the handlebars at all times.

Never carry passengers or allow more than one person at a time to ride the electric motor bike.

Never use near steps or swimming pools.

Keep your fingers and other body parts away from the drive chain, steering system, wheels and all other moving components.

Never use headphones or a cell phone when riding.

Never hitch a ride with another vehicle.

Do not ride the Dirt Rocket in wet or icy weather and never immerse the electric motor bike in water, as the electrical and drive components could be damaged by water or create other possibly unsafe conditions.

The Dirt Rocket is intended for use on flat, level ground without loose debris such as rocks or gravel. Wet, slick, bumpy, uneven or rough surfaces may impair traction and contribute to possible accidents. Do not ride the electric motorbike in mud, ice, puddles or water. Avoid excessive speeds that can be associated with downhill rides. Never risk damaging surfaces such as carpet or flooring by use of an electric motor bike indoors.

Do not ride at night or when visibility is limited.

PROPER RIDING ATTIRE

Always wear proper protective equipment such as an approved safety helmet (with chin strap securely buckled). A helmet may be legally required by local law or regulation in your area. Elbow pads and kneepads, a long-sleeved shirt, long pants and gloves are recommended. Always wear athletic shoes (lace-up shoes with rubber soles), never ride barefooted or in sandals, and keep shoelaces tied and out of the way of the wheels, motor and drive system.

USING THE CHARGER

The charger supplied with the electric motor bike should be regularly examined for damage to the cord, plug, enclosure and other parts, and in the event of such damage, the bike must not be charged until the charger has been repaired or replaced.

Use only with the recommended charger.

Use caution when charging.

The charger is not a toy. Charger should be operated by an adult.

Do not operate charger near flammable materials.

Unplug charger and disconnect from bike when not in use.

Always disconnect from the charger prior to wiping down and cleaning your scooter with liquid.

FAILURE TO USE COMMON SENSE AND HEED THE ABOVE WARNINGS INCREASES RISK OF SERIOUS INJURY. USE WITH APPROPRIATE CAUTION AND SERIOUS ATTENTION TO SAFE OPERATION.

BEFORE YOU BEGIN

Remove contents from box. Remove the foam separators that protect the components from damage during shipping. Inspect the contents of the box for scratches in the paint, dents or kinked cables that may have occurred during shipping. Because the Dirt Rocket is 95 percent assembled and packed at the factory, there should not be any problems, even if the box has a few scars or dents.

MAKE SURE POWER SWITCH IS TURNED "OFF" BEFORE CONDUCTING ANY MAINTENANCE PROCEDURES.

Estimated Assembly and Set-Up Time

Razor recommends assembly by an adult.

Allow up to 30 minutes for assembly.

Allow up to 12 hours for initial charge (see page 4 for charging information).

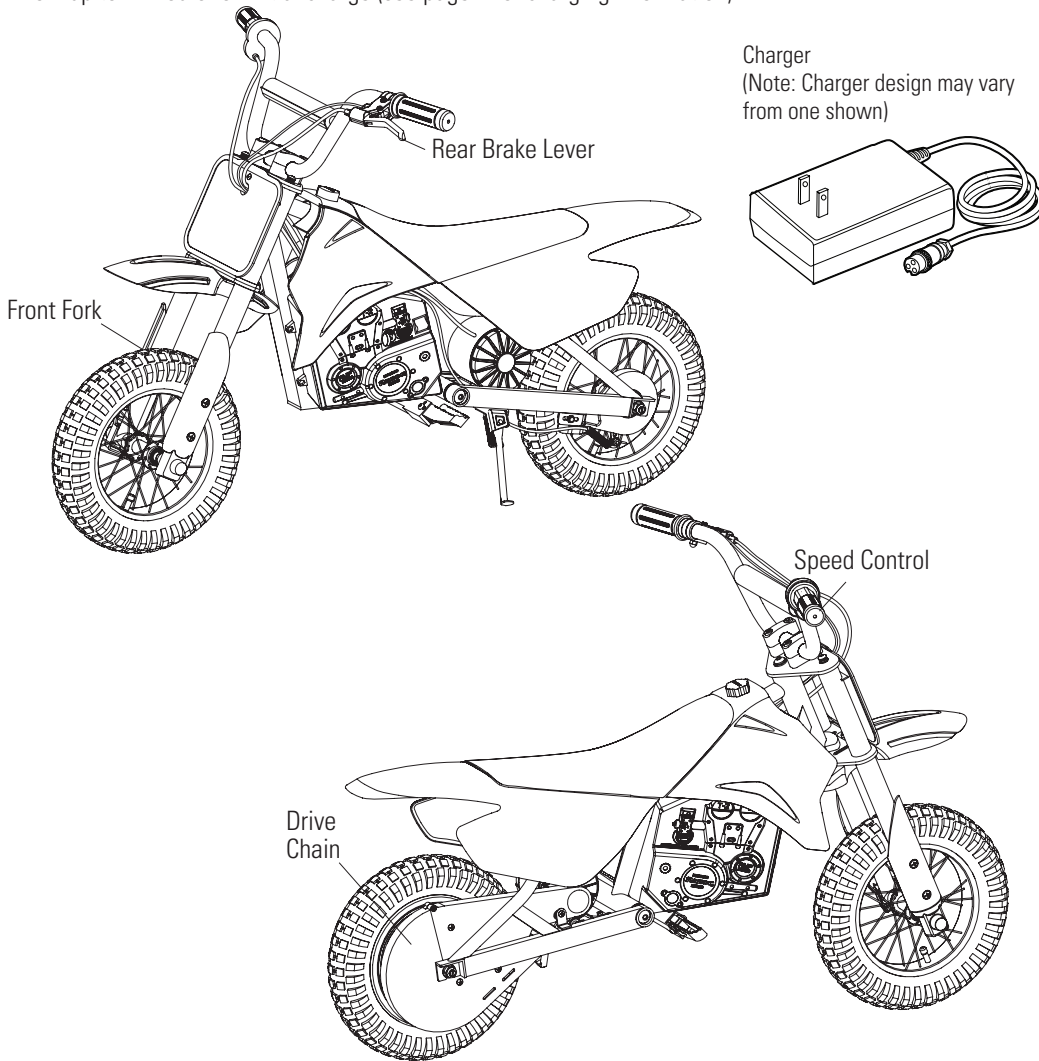

WARNING:
DO NOT USE NON-RAZOR PRODUCTS WITH YOUR RAZOR DIRT ROCKET. The Dirt Rocket has been built to certain Razor design specifications. The original equipment supplied at the time of sale was selected on the basis of its compatibility with the frame, fork and all other parts. Certain aftermarket products may or may not be compatible and may void your warranty.

Required Tools

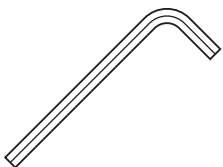

5mm and 6mm Allen wrenches (Included)
3mm Allen wrench (Not Included)



10mm open wrench (Included)
8mm and 15mm open wrenches (Not Included)

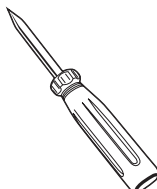

Screwdriver (included)

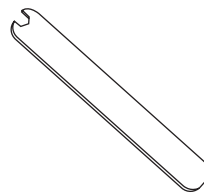

Spoke tightener (Included)

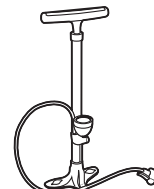

Bicycle tire pump for Schrader valves, with pressure gauge (Not Included)

ASSEMBLY AND SET-UP

□ Attaching the Handlebars MX350 & MX400

Tools required: 6mm Allen wrench

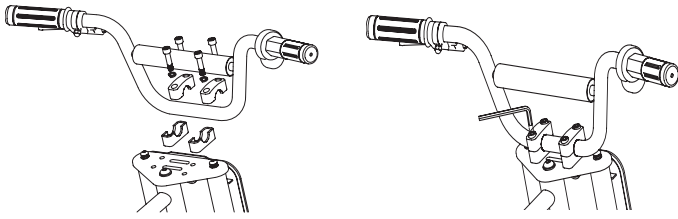

1 Place the handlebars in the handlebar clamps.

2 Align parallel to the fork and tighten the bolts using a 6mm Allen wrench. When properly tightened, the handlebars should not move forward or back.

□ Attaching the Front Fender

Tools required: 10mm open wrench and 5mm Allen wrench

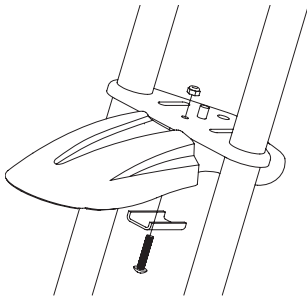

1 Align fender with the hole in the fork and insert the bolt. Tighten securely using a 10mm open wrench and 5mm Allen wrench.

□ Attaching the Number Plate

Tools required: Philips screw driver

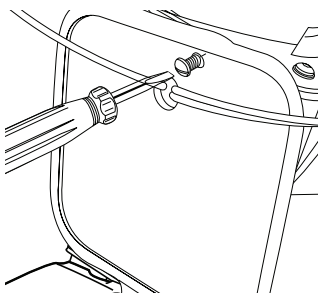

1 Remove screw from front fork. Align the number plate with the hole in the fork and tighten with a Philips screw driver.

⚠ **WARNING:**

Failing to properly adjust and tighten the bolts that affix the handlebars can cause you to lose control and crash.

ASSEMBLY AND SET-UP

□ Inflating the Tires

Tires are inflated when shipped, but they invariably lose some pressure between the point of manufacturing and your purchase.

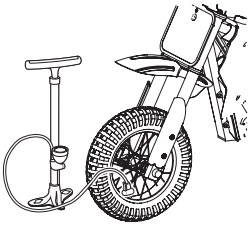

Using a bicycle tire pump equipped for a Schrader valve, inflate both tires to the PSI indicated on the sidewall of the tire.

BEFORE RIDING

□ Charging the Battery

Your electric motorbike may not have a fully charged battery; you must charge the battery prior to use.

- Initial charge time: 12 hours
- Recharge time: up to 12 hours, depending on level of depletion.
- Fully charge battery before storing.
- When the motorbike is not in regular use, recharge the battery at least once a month until normal use is resumed.
- Run time: Up to 30 minutes of continuous ride time. Run time may vary depending on riding conditions, climate and/or proper maintenance.
- Average battery life: 250 charge/discharge cycles
- To ensure long battery life, do not store the battery in temperatures above 75° or below -10° F.

Charger

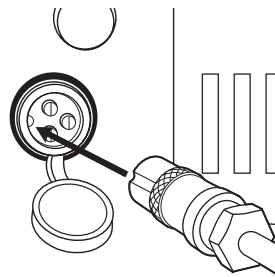
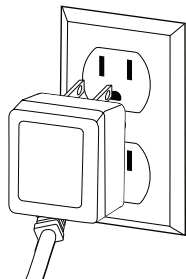
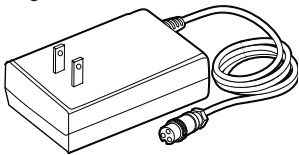

Note: Make sure power is turned **OFF** when unit is not in use. If the power switch is left on for an extended period of time, the battery may reach a stage at which it will no longer hold a charge.

1 Plug the charger into a wall outlet. If the lights on charger do not light up, check the power to the outlet. If necessary, try a different outlet.

2 Turn power **OFF** before charging. Plug the charger into the charger port to charge unit.

Note: The pressurized air supplies found at gasoline stations are designed to inflate high-volume automobile tires. If you decide to use such an air supply to inflate your tires, first make sure the pressure gauge is working, then use very short bursts to inflate to the correct PSI. If you inadvertently over-inflate the tire, release the excess pressure immediately.

⚠ **WARNING:**

Rechargeable batteries are only to be charged under adult supervision. Always disconnect your electric motorbike from the charger before cleaning with liquid.

Note: If your charger does not look like the one illustrated, your unit has been supplied with an alternative charger. The specifications and charging procedure would not change.

The charger has a small window with one LED to indicate the charge status. Refer to the illustration on the charger unit for the actual "charging" and "charged" status indications for your model charger.

Chargers have built-in over-charge protection to prevent battery from being over-charged.

Charger will get warm during use. This is normal for some chargers and is no cause for concern. If your charger does not get warm during use, it does not mean that it is not working properly.

⚠ **WARNING:** Failure to recharge the battery at least once a month may result in a battery that will no longer hold a charge.

REPAIR AND MAINTENANCE

Turn power switch "OFF" before conducting any maintenance procedures.

□ Adjusting the Brakes

Tools required: 10mm open wrench

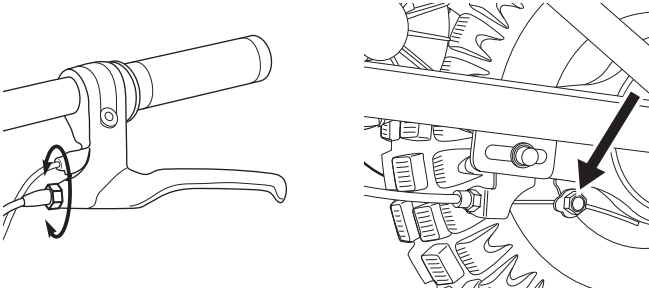

1 To adjust the tension, thread the brake lever adjuster in or out 1/4 to 1/2 turn until the desired brake adjustment is attained. Most adjustments are complete at this step. If brake still needs further adjustment, proceed to step 2.

2 If the brake has too much slack, use a 10mm open wrench to loosen the brake anchor cable for additional adjustment.

□ Testing the Brakes

To use the brake, squeeze the lever to increase the pressure on the brake. The brake lever is fitted with a cable adjuster to compensate for cable stretch and/or to fine-tune the lever movement to brake engagement. If brake is not engaging properly, follow instructions for adjusting the brakes outlined below.

□ Chain and Rear Tire Replacement

Tools required: 10mm open wrench, two (2) 8mm open wrenches, and two (2) 15mm open wrenches.

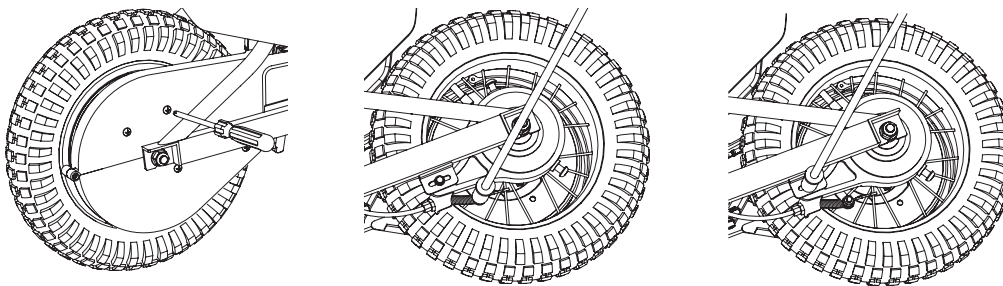

1 Loosen screws and remove chain guard.

2 With a 10mm open wrench, loosen the brake cable anchor and disconnect the cable.

3 With two 8mm open wrenches, loosen brake housing anchor and disconnect. Keep the spacer and washers together.

⚠ WARNING:

The brake is capable of causing the electric motorbike to skid the tire throwing an unsuspecting rider. Practice in an open area free from obstacles until you are familiar with the brake function. Avoid skidding to a stop as this can cause you to lose control or damage the rear tire.

REPAIR AND MAINTENANCE

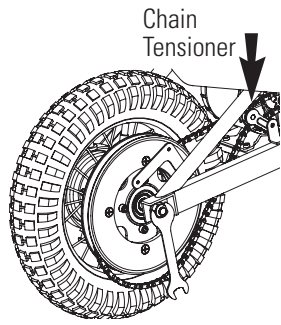

4 With two 15mm open wrenches, loosen the axle. Push the chain tensioner down to loosen the chain and pull the wheel out.

Note: Your hands will get greasy doing this.

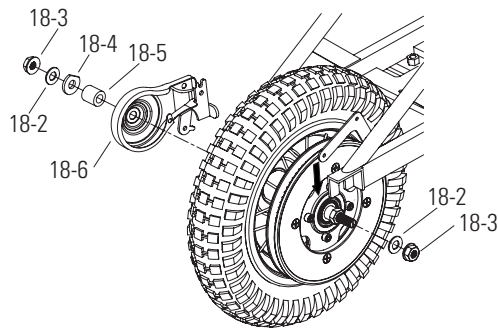

Note the sequence of the hardware

Right Side (Throttle)

- 18-2 Flat Washer
- 18-3 M10 Flange Locknut

Left Side (Brake)

- 18-6 Brake Plate
- 18-5 Spacer
- 18-4 4mm Washer
- 18-2 Flat Washer
- 18-3 M10 Flange Locknut

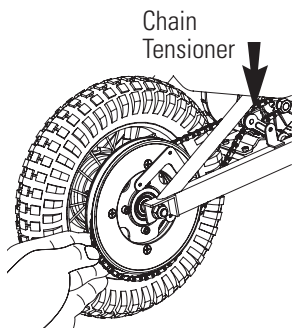

5 Install the new chain or wheel by slipping the chain around the axle. Slide the axle into the slots on the frame. Slide the chain tensioner down and maneuver the chain onto the sprocket on the rear wheel and motor.

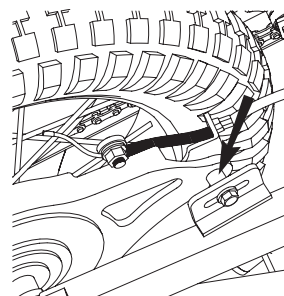

6 To re-attach the brake housing anchor, align the cable guide adjuster and install the spacer and bolt. Do not tighten until final step.

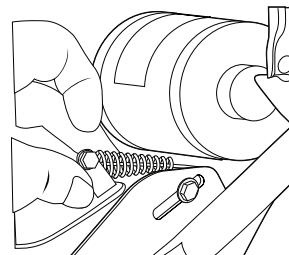

7 Install the brake spring and thread the cable wire into the cable anchor. Thread the cable to its original position and tighten securely.

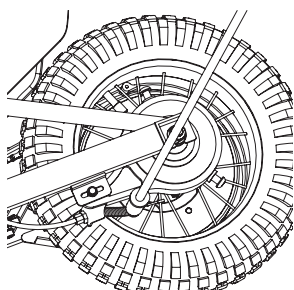

8 Tighten the brake housing anchor securely. Re-attach the chain guard. Test ride. Readjust as needed.

REPAIR AND MAINTENANCE

□ Replacing the Fuse

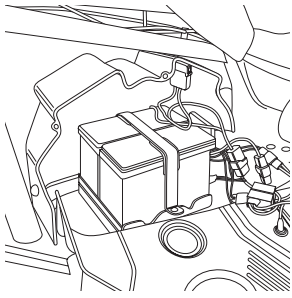

1 Remove the battery cover.

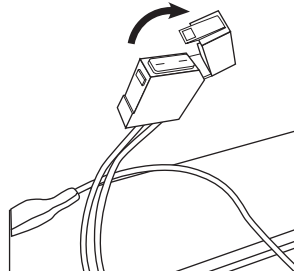

2 Locate the fuse box attached to the batteries. Open the fuse cover to expose the fuse.

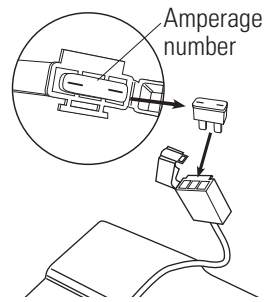

3 Remove the fuse and replace with a new one of equal amperage. Requires 30 amp fuse. Close the fuse cover and reattach the battery cover.

⚠ WARNING:

To prevent shock, please follow the instructions accordingly and do not skip or combine any steps.

□ Checking Spoke Tension

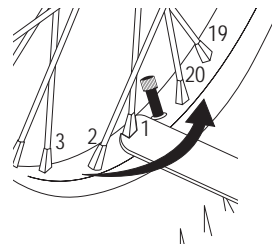
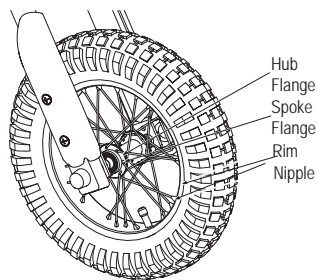
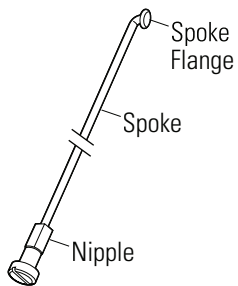

1 Verify the spoke tension by grasping and shaking each spoke. Spoke should not be loose from hub. Look for any play between the spoke flanges where it mates with the hub. Try to turn the nipple using your fingers. You should not be able to spin any nipple by hand. If one or more spokes is loose, all spokes should be checked and tightened with a spoke wrench if needed.

2 Start with spoke closest to the tire valve stem and tighten each nipple, in sequence, exactly 1/4 to 1/2 turn. A single 1/4 to 1/2 turn may not be enough to bring the spokes into proper tension. Continue tightening all spokes no more than 1/2 turn in sequence until all spokes are tight.

Note: More than a 1/2 turn each can cause the wheel to become distorted and wobbly thus permanently damaging the wheel.

REPAIR AND MAINTENANCE

❑ Chain and Sprocket

The chain will typically have a "loose spot" and "tight spot" corresponding with a particular sprocket rotational position. This is normal and common to all chain-driven products due to run-out tolerances of the freewheel and sprocket. The chain should be adjusted to the ideal tension with chain in the tightest spot.

Proper chain alignment must be maintained. The wheel must not be skewed. If the chain is noisy or rough running, check the lubrication, tension and alignment of the sprockets, in that order.

❑ Battery Care and Disposal

Do not store the battery in temperatures above 75° F or below -10° F.



CONTAINS SEALED NON-SPILLABLE LEAD BATTERIES. BATTERIES MUST BE RECYCLED.

Disposal: Your Razor product uses sealed lead-acid batteries which must be recycled or disposed of in an environmentally sound manner. Do not dispose of a lead-acid battery in a fire. The battery may explode or leak. Do not dispose of a lead-acid battery in your regular household trash. The incineration, land filling or mixing of sealed lead-acid batteries with household trash is prohibited by law in most areas. Return exhausted batteries to a federal or state approved lead-acid battery recycler or a local seller of automotive batteries. If you live in Florida or Minnesota, it is prohibited by law to throw away lead-acid batteries in the municipal waste stream.

❑ Charger

The charger supplied with the bike should be regularly examined for damage to the cord, plug, enclosure and other parts, and, in the event of such damage, the motorbike must not be charged until it has been repaired or replaced.

Use **ONLY** with the recommended charger.

WARNING:

To avoid a pinch or injury, keep fingers away from moving sprockets and chain.

WARNING:

If a battery leak develops, avoid contact with the leaking acid and place the damaged battery in a plastic bag. Refer to the disposal instructions at left. If acid comes into contact with skin or eyes, flush with cool water for at least 15 minutes and contact a physician.

 **WARNING:** Battery posts, terminals and related accessories contain lead and lead compounds. **Wash your hands after handling.**

TROUBLESHOOTING GUIDE

Problem	Possible Cause	Solution
Motor bike does not run	Undercharged battery	Charge the battery. A new battery should have been charged for at least 12 hours before using the motor bike for the first time and up to 12 hours after each subsequent use. Check all connectors. Make sure the charger connector is tightly plugged into the charging port, and that the charger is plugged into the wall. Make sure power flow to the wall outlet is on.
	Loose wires or connectors	Check all wires and connectors to make sure they are tight. The fuse will burn out and automatically shut off the power if the motor is overloaded.
	Burned-out fuse	An excessive overload, such as too heavy a rider or too steep a hill, could cause the motor to overheat. Replace the fuse with a new one of equal amperage. Correct the conditions that caused the fuse to burn out and avoid repeatedly burning out fuse.
Motor bike was running but suddenly stopped	Motor or electrical switch damage	Contact your local Razor authorized service center for diagnosis and repair.
	Undercharged battery	Charge the battery. A new battery should have been charged for at least 12 hours before using the motor bike for the first time and up to 12 hours after each subsequent use. Check all wires and connectors. Make sure the battery connector is tightly plugged into the charger connector, and that the charger is plugged into the wall.
Short run time (less than 15 minutes per charge)	Tires are not properly inflated	The tires are inflated when shipped but they invariably will lose some pressure between the point of manufacturing and your purchase. Refer to instructions on page 4 of this manual to properly inflate tires.
	Battery is old and will not accept full charge	Even with proper care, a rechargeable battery does not last forever. Average battery life is 1 to 2 years depending on product use and conditions. Replace only with a Razor replacement battery.
	Brakes are not adjusted properly	Refer to brake adjustment instructions on page 5 of this manual.
	Riding conditions are too stressful	Use only on solid, flat, clean and dry surfaces such as pavement or level ground.
Motor bike runs sluggishly	Tires are not properly inflated	The tires are inflated when shipped, but they invariably will lose some pressure between the point of manufacturing and your purchase. Refer to instructions on page 4 of this manual to properly inflate tires.
	Motor bike is overloaded	Make sure you do not overload the motor bike by allowing more than one rider at one time, exceeding the maximum weight limit, going up too steep a hill or towing objects behind the vehicle.

TROUBLESHOOTING GUIDE

Problem	Possible Cause	Solution
Sometimes the motor bike doesn't run, but other times it does	Loose wires or connectors	Check all wires around the motors and all connectors to make sure they are tight.
	Motor or electrical switch damage	Contact your local Razor authorized service center for diagnosis and repair.
Charger gets warm during use	Normal response to charger use	No action required. This is normal for some chargers and is no cause for concern. If your charger does not get warm during use, it does not mean that it is not working properly.
Motor bike does not stop when applying the brake	Brakes are not adjusted properly	Refer to instructions on page 5 of this manual to properly adjust brakes.
Motor bike makes loud noises or grinding sounds	Chain is too dry	Apply a lubricant such as 3 in 1™ or Tri-Flow™ to the chain.

MX350 / MX400 PARTS

(Specifications subject to change without notice.)

- | | | | | | |
|------|----------------------------------|-----|----------------------------|-----|---------------------|
| 1. | Handlebar Grip (Right/Left) | 7. | Front Fork | 14. | Charger Port |
| 2. | Single Speed Twist Grip Throttle | 8. | Front Fender | 15. | Control Module |
| 2-1. | Sleeve | 9. | Fork Cover (Right/Left) | 16. | Kickstand |
| 3. | Handlebar | 10. | Battery (2- 12V/ 7Ah) | 17. | Motor (24V / 250W) |
| 4. | Brake Lever Assembly | 11. | Fuse | 18. | Rear Wheel Complete |
| 5. | Handlebar Clamp (Upper/Lower) | 12. | Battery Cover (Right/Left) | 19. | Chain |
| 6. | Front Wheel Complete | 13. | On/ Off Switch | 20. | Chain Guard |
| | | | | 21. | Seat Fairing |

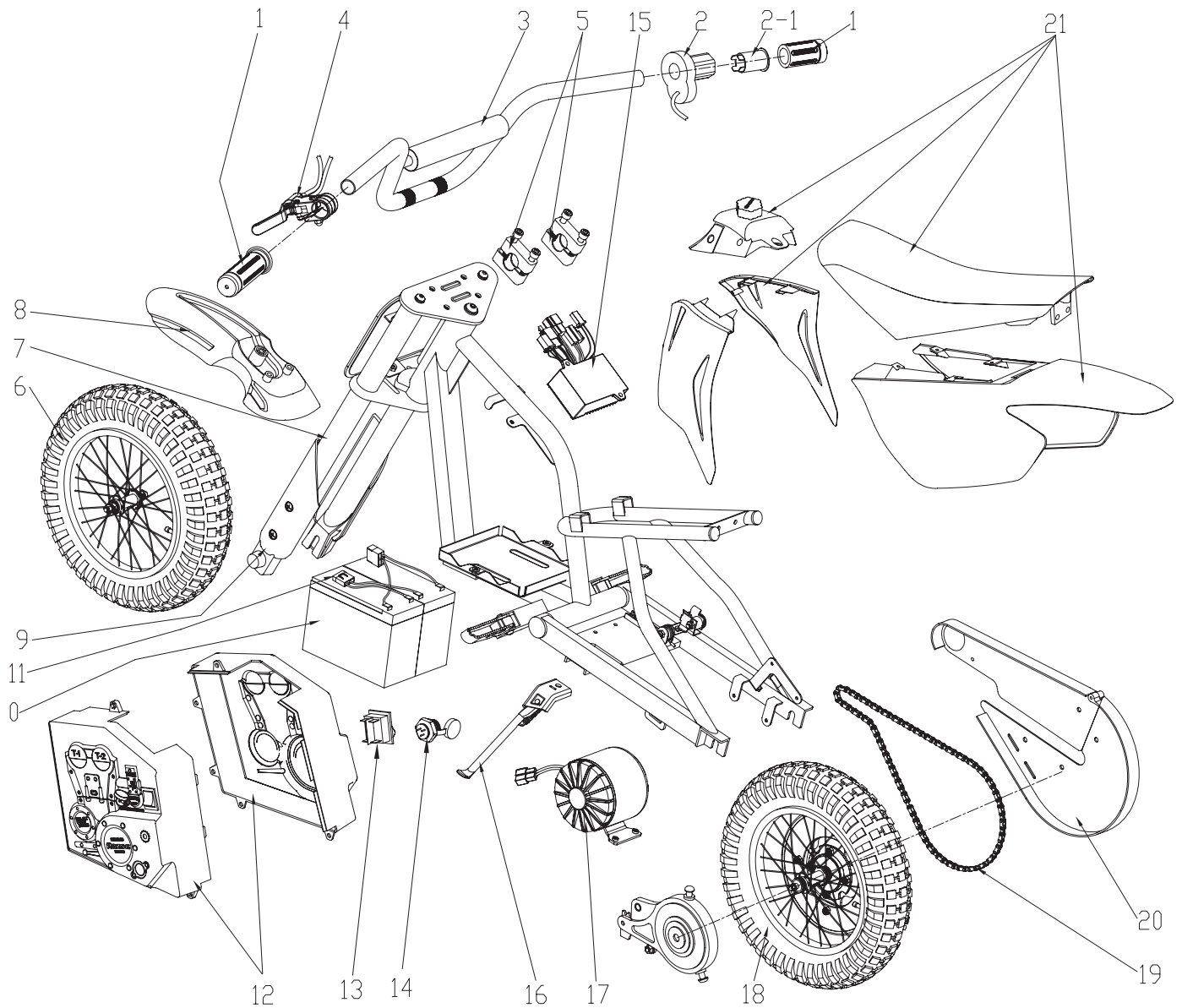

SB 1918 (CALIFORNIA) DECLARATION

YOUR INSURANCE POLICIES MAY NOT PROVIDE COVERAGE FOR ACCIDENTS INVOLVING THE USE OF THIS SCOOTER/ELECTRIC RIDE-ON PRODUCT. TO DETERMINE IF COVERAGE IS PROVIDED, YOU SHOULD CONTACT YOUR INSURANCE COMPANY OR AGENT.

SAFETY REMINDERS

PRE-RIDE CHECKLIST



Loose Parts

Check and secure all fasteners before every ride. Make sure handlebar clamp bolts are locked properly in place. There should not be any unusual rattles or sounds from loose parts or broken components. If you are not sure, ask an experienced mechanic to check.



Brake

Check the brake for proper function. When you squeeze the lever, the brake should provide positive braking action. When you apply the brake with the speed control on, the brake cut-off switch will stop the motor.



Frame, Fork and Handlebars

Check for cracks or broken connections. Although broken frames are rare, it is possible for an aggressive rider to run into a curb or wall and wreck and bend or break a frame. Get in the habit of inspecting yours regularly.



Tire Inflation

Periodically inspect the tires for excess wear, and regularly check the tire pressure and re-inflate as necessary. If you get a flat tire, the inner tube can be patched or a new tube can be purchased from Razor or an authorized repair center.



Safety Gear

Always wear proper protective equipment such as an approved safety helmet, elbow pads and kneepads. Always wear athletic shoes (lace-up shoes with rubber soles), never ride barefooted or in sandals, and keep shoelaces tied and out of the way of the wheels, motor and drive system.

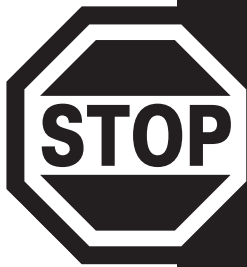

DO NOT RETURN TO STORE

Do not use this product for the first time until you have inflated the tires to the correct PSI and charged the battery for at least 12 hours.

Failure to follow these instructions may damage your product and void your warranty.

WARRANTY

Razor Limited Warranty

The manufacturer warrants this product to be free of manufacturing defects for a period of 90 days from date of purchase. This Limited Warranty does not cover normal wear and tear, tires, tubes, cables or any damage, failure or loss caused by improper assembly, maintenance, or storage or use of the Razor Dirt Rocket.

This Limited Warranty will be void if the product is ever:

- used in a manner other than for recreation or transportation;
- modified in any way;
- rented.

The manufacturer is not liable for incidental or consequential loss or damage due directly or indirectly to the use of this product.

Razor does not offer an extended warranty. If you have purchased an extended warranty, it must be honored by the store at which it was purchased.

For your records, save your original sales receipt with this manual and write the serial number below.

Item Numbers:

MX350 15128040

MX400 15128030