

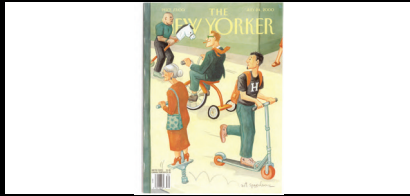

2020 US CATALOG

HISTORY & AWARDS



2000 THE ORIGINAL RAZOR LAUNCHES - 5 MILLION SOLD IN 6 MONTHS



2001 RAZOR SCOOTER TOY OF THE YEAR



2002 REINVENTED CLASSIC SCREAM MACHINE



2003 RAZOR INTRODUCES ELECTRIC SCOOTERS



2004 CREATION OF NEW ELECTRIC RIDE-ON CATEGORY



2005 PRO MODEL KICK SCOOTER LAUNCHES



2006 PLAYTHINGS GIVES TOP 15 AWARDS TO MX350, E300, AND POCKET MOD



2007 RIPSTIK DEBUTS WITH NATIONAL TV ADVERTISING



2008 POWERWING SIDE-TO-SIDE TECHNOLOGY



2009 RIPRIDER 360 DOMINATES MARKET ACCOLADES



2010 10TH ANNIVERSARY 35 MILLION SCOOTERS SOLD



2011 PRO SCOOTER MOVEMENT TAKES OFF



2012 TEAM RAZOR DEMOS X-GAMES LOS ANGELES



2013 FLASHRIDER 360 OUTDOOR TOY OF THE YEAR FINALIST



2014 CRAZY CART WINNER OUTDOOR TOY OF THE YEAR



2015 15TH ANNIVERSARY 48 MILLION SCOOTERS SOLD



2016 HOVERTRAX 2.0 DEBUTS WITH NATIONAL TV AND DIGITAL ADVERTISING



2017 RAZORX ELECTRIC SKATEBOARDS LAUNCH



2018 TURBO JETTS OUTDOOR TOY OF THE YEAR FINALIST



2019 UB1 BEST OF TOY BUZZ AWARD



HISTORY & AWARDS

2



KICK SCOOTERS

4



RIDE-ONS

20



ELECTRIC SCOOTERS

32



ELECTRIC RIDE-ONS

54



DIRT

76



RIPSTIK

88



ACCESSORIES

98



RAZOR JR.

104

A5 LUX LIGHT-UP

A5 LUX

A5 DLX

A5 AIR

A5 PRIME

A6

A3

A2

A

PARTY POP

TEKNO

SPARK ULTRA

BEAST V6





KICK SCOOTERS

The legendary scooters that started it all! Shred the pavement, bust out big tricks, or just cruise around town in style. With innovative design, quality construction and cool features, these are the scooters that sparked a revolution.

A5 LUX LIGHT-UP

SPECIFICATIONS:

- **T-tube:** Anodized aluminum with multi-color graphic decal
- **Handlebars:** Adjustable-height, folding
- **Grips:** Foam
- **Downtube:** Folding
- **Deck:** Anodized aluminum with multi-color, full-deck grip tape
- **Wheels:** Light-up, 8" (200 mm), urethane
- **Brake:** Rear-fender
- **Kickstand:** Retractable

RIDER TYPE:

- **Age:** 8+
- **Max Rider Weight:** 220 lb (100 kg)

COLORS:

 OR | Item#: 13013280 | UPC: 8-45423-02352-2

 GR | Item#: 13013230 | UPC: 8-45423-02353-9



No assembly required



Always check local laws to see where and how particular Razor products may be ridden. An adult's decision to permit a child to use these products should be based upon Razor's recommendations and the child's skills, maturity and the ability to follow rules. Product specifications subject to change.

A5 LUX

Time To Upgrade To Deluxe. The popular kick scooter in a deluxe size. With extra-large urethane wheels and a cool profile, it's the smoothest ride around! The A5 Lux kick scooter is easy to fold and ready to go.

SPECIFICATIONS:

- **T-tube/Deck:** Anodized aluminum
- **Handlebars:** Adjustable-height, folding
- **Grips:** Foam
- **Downtube:** Folding
- **Wheels:** 8" (200 mm), urethane
- **Brake:** Rear-fender
- **Kickstand:** Retractable

RIDER TYPE:

- **Age:** 8+
- **Max Rider Weight:** 220 lb (100 kg)

COLORS:

 BL | Item#: 13013240 | UPC: 8-45423-01064-5

 PK | Item#: 13013261 | UPC: 8-45423-01662-3

 SL | Item#: 13013201 | UPC: 8-45423-00295-4



No assembly required



Always check local laws to see where and how particular Razor products may be ridden. An adult's decision to permit a child to use these products should be based upon Razor's recommendations and the child's skills, maturity and the ability to follow rules. Product specifications subject to change.

A5 DLX

The Go-To Ride For An On-The-Go Lifestyle. Building on our classic A5 Lux frame, the A5 DLX adds our patent-pending, anti-rattle system to deliver a smooth, solid ride. Paired with extra-large, urethane wheels and super-strong, aluminum t-tube and deck, the A5 DLX is the king of comfort for quick cruises or long joy rides.

SPECIFICATIONS:

- **T-tube/Deck:** Anodized aluminum
- **Handlebars:** Width 16.75" (425 mm), adjustable-height and patent-pending, anti-rattle, folding T-bar
- **Grips:** Foam
- **Downtube:** Patent-pending, anti-rattle, folding mechanism
- **Wheels:** 8" (200 mm), urethane
- **Brake:** Rear-fender
- **Kickstand:** Retractable

RIDER TYPE:

- **Age:** 8+
- **Max Rider Weight:** 220 lb (100 kg)

COLOR:

SL | Item#: 13013211 | UPC: 8-45423-01827-6



**ANTI-RATTLE
TECHNOLOGY™**

No assembly required



Always check local laws to see where and how particular Razor products may be ridden. An adult's decision to permit a child to use these products should be based upon Razor's recommendations and the child's skills, maturity and the ability to follow rules. Product specifications subject to change.

A5 AIR

Transform Your Commute! The Razor A5 Air is built for everyday commuting on rough, urban terrain. Designed with reliability and durability in mind, the A5 Air's super-strong construction, pneumatic, commuter tires, and patent-pending, anti-rattle technology make it the ideal daily ride.

SPECIFICATIONS:

- **T-tube/Deck:** Aluminum
- **Handlebars:** Width 16.75" (425 mm), adjustable-height and anti-rattle, folding T-bar
- **Grips:** Soft, rubber
- **Downtube:** Patent-pending, anti-rattle, folding mechanism
- **Fork:** Steel with plastic fender
- **Deck:** Length 13.4" (340 mm)
- **Tires:** 8" (200 mm), pneumatic (60 PSI), commuter
- **Brake:** Rear-fender
- **Kickstand:** Retractable

RIDER TYPE:

- **Age:** 8+
- **Max Rider Weight:** 220 lb (100 kg)

COLORS:

 BK | Item#: 13013205 | UPC: 8-45423-01830-6

 SL | Item#: 13013290 | UPC: 8-45423-01825-2



No assembly required

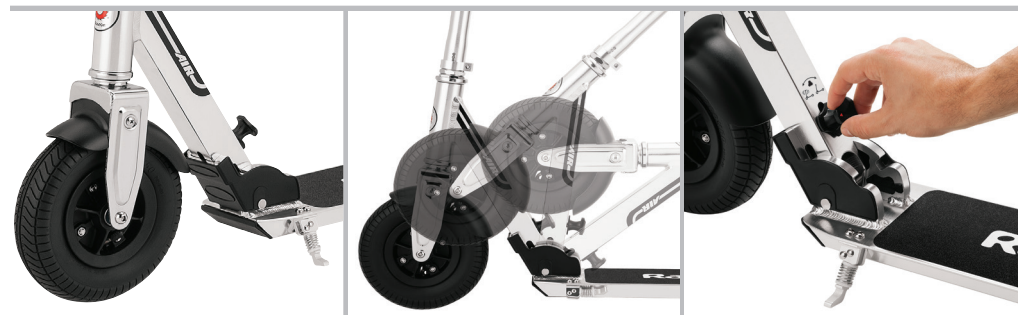

Always check local laws to see where and how particular Razor products may be ridden. An adult's decision to permit a child to use these products should be based upon Razor's recommendations and the child's skills, maturity and the ability to follow rules. Product specifications subject to change.

A5 PRIME

The Premier Kick Scooter. The Razor A5 Prime is a sleek, high-style, sophisticated scooter fusing modern design and craftsmanship unique to the scooter market. The A5 Prime features the patent-pending, anti-rattle system and includes taller, easy-adjust handlebars, wider deck and extra-large wheels to accommodate taller riders. The A5 Prime is built to be the next must-own scooter.

SPECIFICATIONS:

- **Frame:** Anodized aluminum
- **Handlebars:** Width 16.75" (425 mm), two-degree sweep, adjustable-height
- **Grips:** Prism-shaped design molded in soft rubber
- **Clamp:** Double-stacked
- **Downtube:** Hydro-formed aluminum, featuring patent-pending, anti-rattle, folding mechanism
- **Fork:** One-piece billet, aluminum
- **Deck:** Extrusion profile: length 13.4" (340 mm), width 5.1" (130 mm)
- **Wheels:** Exclusive spoke design, 8" (200 mm), urethane
- **Brake:** Rear-fender
- **Kickstand:** Retractable, center stand

RIDER TYPE:

- **Age:** 8+
- **Max Rider Weight:** 220 lb (100 kg)

COLOR:

GM | Item#: 13013215 | UPC: 8-45423-01743-9



ANTI-RATTLE TECHNOLOGY™

Some assembly required



Always check local laws to see where and how particular Razor products may be ridden. An adult's decision to permit a child to use these products should be based upon Razor's recommendations and the child's skills, maturity and the ability to follow rules. Product specifications subject to change.

A6

You're Never Too Tall To Ride! The Razor A6 kick scooter was designed and constructed with taller riders in mind. No more hunching over, the A6 features handlebars that adjust to an incredible height of 42" (1067 mm), an extra-long deck with additional foot room, and ultra-sized, ultra-sturdy, 10" (254 mm) urethane wheels. Built to last with a super-strong, folding aluminum frame, and patent-pending, anti-rattle technology, the A6 takes riding to new heights.

SPECIFICATIONS:

- **Frame:** Anodized aluminum
- **Handlebars:** Width 16.75" (425 mm), adjustable-height up to 42" (1067 mm) and anti-rattle, folding
- **Grips:** Foam
- **Downtube:** Patent-pending, anti-rattle, folding mechanism
- **Deck:** Length 13.4" (340 mm)
- **Wheels:** Spoked, 10" (254 mm), urethane with double bearings
- **Brake:** Rear-fender
- **Kickstand:** Retractable

RIDER TYPE:

- **Age:** 8+
- **Max Rider Weight:** 220 lb (100 kg)

COLORS:



WT | Item#: 13013710 | UPC: 8-45423-01832-0



SL | Item#: 13013713 | UPC: 8-45423-01823-8



No assembly required



Always check local laws to see where and how particular Razor products may be ridden. An adult's decision to permit a child to use these products should be based upon Razor's recommendations and the child's skills, maturity and the ability to follow rules. Product specifications subject to change.

A3

The A3 kick scooter is an updated version of the original Razor kick scooter, with larger wheels to ensure a smoother ride. The front fork is equipped with a springless suspension system and also includes a wheelie bar.





SPECIFICATIONS:

- **T-tube/Deck:** Aluminum with wheelie bar
- **Handlebars:** Adjustable-height, folding
- **Grips:** Foam
- **Downtube:** Folding
- **Fork:** Springless suspension
- **Wheels:** Large, urethane
- **Brake:** Rear-fender

RIDER TYPE:

- **Age:** 5+
- **Max Rider Weight:** 143 lb (65 kg)

COLORS:

-  BL | Item#: 13014340 | UPC: 8-45423-00289-3
-  CL | Item#: 13014300 | UPC: 8-45423-00288-6
-  GR | Item#: 13014330 | UPC: 8-45423-00291-6
-  RD | Item#: 13014360 | UPC: 8-45423-00290-9



No assembly required

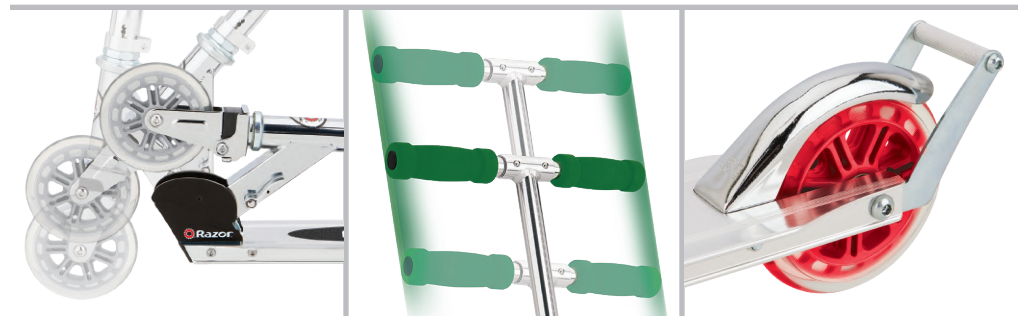

Always check local laws to see where and how particular Razor products may be ridden. An adult's decision to permit a child to use these products should be based upon Razor's recommendations and the child's skills, maturity and the ability to follow rules. Product specifications subject to change.

A2

With the phenomenal success of the original A model kick scooter, Razor expanded the line with the A2. Sleek, with that classic aluminum style, Razor added cool features, including springless front suspension and a wheelie bar.

SPECIFICATIONS:

- **T-tube/Deck:** Aluminum with wheelie bar
- **Handlebars:** Adjustable-height, folding
- **Grips:** Foam
- **Downtube:** Folding
- **Fork:** Springless suspension
- **Wheels:** Urethane
- **Brake:** Rear-fender

RIDER TYPE:

- **Age:** 5+
- **Max Rider Weight:** 143 lb (65 kg)

COLORS:

 PU | Item#: 13003A2-PU | UPC: 8-45423-00278-7

 BL | Item#: 13003A2-BL | UPC: 8-45423-00277-0

 CL | Item#: 13003A2-CL | UPC: 8-45423-00280-0

 RD | Item#: 13003A2-RD | UPC: 8-45423-00282-4



No assembly required



Always check local laws to see where and how particular Razor products may be ridden. An adult's decision to permit a child to use these products should be based upon Razor's recommendations and the child's skills, maturity and the ability to follow rules. Product specifications subject to change.

A

The Original and Still The Best. A revolution in motion, the Razor A kick scooter has set the standard for fun since it launched a global phenomenon. Still one of the most talked about and desired rides, our iconic kick scooter combines pass-down quality with timeless design for a ride that never goes out of style.

SPECIFICATIONS:

- **T-tube/Deck:** Aluminum
- **Handlebars:** Adjustable-height, folding
- **Grips:** Foam
- **Downtube:** Folding
- **Wheels:** Urethane
- **Brake:** Rear-fender
- **Sweet Pea A:** Includes bell and streamers

RIDER TYPE:

- **Age:** 5+
- **Max Rider Weight:** 143 lb (65 kg)

COLORS:

 GR | Item#: 13003A-GR | UPC: 8-45423-00267-1

 BL | Item#: 13003A-BL | UPC: 8-45423-00263-3

 CL | Item#: 13003A-CL | UPC: 8-45423-00264-0

 PK | Item#: 13010067 | UPC: 8-45423-00898-7

 RD | Item#: 13003A-RD | UPC: 8-45423-00266-4

 **SWEET PEA**
PK | Item#: 13012062 | UPC: 8-45423-00227-5



No assembly required



Always check local laws to see where and how particular Razor products may be ridden. An adult's decision to permit a child to use these products should be based upon Razor's recommendations and the child's skills, maturity and the ability to follow rules. Product specifications subject to change.

PARTY POP

The light-up Party Pop is a party on wheels! Stepping on the deck fires up the pulsating multi-color light show that keeps the fun rolling with kick power to tour the neighborhood.

SPECIFICATIONS:

- **T-tube/Frame:** Steel
- **Grips:** Foam
- **Downtube:** Non-folding, rigid
- **Wheels:** Urethane
- **Deck:** 12 multi-color LED lights, polypropylene
- **Brake:** Rear-fender
- **Batteries:** Two (2) AAA (included and replaceable)
- **Approximate Battery Life:** 20 hours or 3,600 cycles
- **Packaging:** "Try Me" box

RIDER TYPE:

- **Age:** 6+
- **Max Rider Weight:** 143 lb (65 kg)

COLOR:

■ PU | Item#: 13011762 | UPC: 8-45423-01474-2



Some assembly required

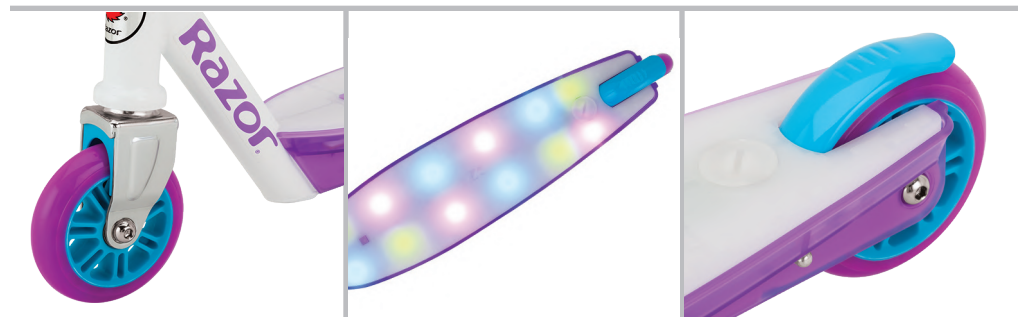

Always check local laws to see where and how particular Razor products may be ridden. An adult's decision to permit a child to use these products should be based upon Razor's recommendations and the child's skills, maturity and the ability to follow rules. Product specifications subject to change.

TEKNO

Ride The Light! Break new frontiers of light and fun with the neon glow of the futuristic Tekno light-up scooter. Step on board and step up the excitement with a new dimension of flashing fun as pulsating blue lights give your ride a digital edge.

SPECIFICATIONS:

- **T-tube/Frame:** Steel
- **Grips:** Foam
- **Downtube:** Non-folding, rigid
- **Wheels:** Urethane
- **Deck:** 12 blue LED lights, polypropylene
- **Brake:** Rear-fender
- **Batteries:** Two (2) AAA (included and replaceable)
- **Approximate Battery Life:** 20 hours or 3,600 cycles
- **Packaging:** "Try Me" box

RIDER TYPE:

- **Age:** 6+
- **Max Rider Weight:** 143 lb (65 kg)

COLOR:

■ BK | Item#: 13011701 | UPC: 8-45423-01567-1



Some assembly required



Always check local laws to see where and how particular Razor products may be ridden. An adult's decision to permit a child to use these products should be based upon Razor's recommendations and the child's skills, maturity and the ability to follow rules. Product specifications subject to change.

SPARK ULTRA

Lightning On Wheels. The Spark Ultra is a blur of brilliant light that's ready to take riders to a new dimension of fun. Featuring the brightest LED wheels of any scooter in the Razor lineup, the Spark Ultra doubles down on flash with every blast from its Spark Bar for a glowing ride that will light it up all day long. The full-length grip tape sets the tone with its spark-inspired design, while the folding system makes it easy to take this show on the go.

SPECIFICATIONS:

- **Spark Bar:** Includes replaceable spark cartridge (additional replacements sold separately)
- **T-tube:** Aluminum
- **Handlebars:** Adjustable-height, folding
- **Grips:** Foam
- **Downtube:** Folding
- **Deck:** Aluminum with full-deck grip tape
- **Wheels:** Ultra-bright LED, urethane
- **Brake:** Rear-fender

RIDER TYPE:

- **Age:** 8+
- **Max Rider Weight:** 143 lb (65 kg)

COLORS:

 RD | Item#: 13010455 | UPC: 8-45423-02075-0

 OR | Item#: 13010412 | UPC: 8-45423-01970-9



No assembly required



Always check local laws to see where and how particular Razor products may be ridden. An adult's decision to permit a child to use these products should be based upon Razor's recommendations and the child's skills, maturity and the ability to follow rules. Product specifications subject to change.

BEAST V6

Roar onto the scene, throwing down tricks like a pro, on the Razor Beast V6 sport scooter! A pro-style stunt scooter for more advanced riders, the Beast V6 features custom-designed graphics on a pro-style, aluminum deck, a fixed, riser-style handlebar, soft, rubber grips, and 100 mm, solid core, urethane wheels with smooth-rolling bearings for a fast ride and sick stunts. Rule the skatepark on the Beast V6.

SPECIFICATIONS:

- **Handlebars:** Width 18" (457 mm), height 21" (533 mm), fixed, riser-style, heavy-duty, steel
- **Grips:** Soft, rubber
- **Clamp:** Quad-stacked
- **Fork:** Heavy-duty, steel
- **Deck:** Width 3.94" (100 mm), length 19.1" (485 mm), aluminum
- **Grip Tape:** Full-deck with custom-designed graphics
- **Wheels:** Metalized solid core, 100 mm, urethane
- **Brake:** Contoured spring, rear-fender

RIDER TYPE:

- **Age:** 6+
- **Max Rider Weight:** 220 lb (100 kg)

COLOR:



RD | Item#: 13017957 | UPC: 8-45423-02187-0



Some assembly required



Always check local laws to see where and how particular Razor products may be ridden. An adult's decision to permit a child to use these products should be based upon Razor's recommendations and the child's skills, maturity and the ability to follow rules. Product specifications subject to change.



- JETTS DLX
- JETTS
- DXT
- DELTAWING
- POWERWING DLX
- POWERWING
- FLASHRIDER 360
- RIPRIDER 360
- GOGO POGO





RIDE-ONS

The radical way to ride! Wing it, drift it, spin like crazy. Standing or sitting, these awesome machines produce a crazy ride style that's easy to learn. You'll be freestyling in no time. Rip it up with a Razor ride-on!

JETTS DLX

Light, Spark 'N' Roll! Put your sneakers into warp drive with the Razor Jetts DLX heel wheels. The glowing, LED wheels and translucent, polycarbonate frame will take you to another dimension of fun, with an extra burst of flashing sparks when you want to really light it up. Step up, strap down and roll out with the brightest ride around.

SPECIFICATIONS:

- **Spark Pads:** Easily removable and replaceable
- **Frame:** Translucent, polycarbonate "quick click" with hook-and-loop strap
- **Wheels:** LED lighted, 50 mm urethane with sealed bearings
- **Sizes:** Fits shoe sizes U.S. youth 12 through adult 12 (European youth 42 through adult 45)
- **Includes:** Spark pads and skid pads
- **Patent Pending**

RIDER TYPE:

- **Age:** 8+
- **Max Rider Weight:** 176 lb (80 kg)

COLORS:

 GR | Item#: 25056196 | UPC: 8-45423-01836-8

 PK | Item#: 25056161 | UPC: 8-45423-01923-5



No assembly required



Always check local laws to see where and how particular Razor products may be ridden. An adult's decision to permit a child to use these products should be based upon Razor's recommendations and the child's skills, maturity and the ability to follow rules. Product specifications subject to change.

JETTS

You Are Clear For Takeoff! Fire up your afterburner and get your spark on with the high-flying Jetts by Razor. Just step up, strap down and take off with these easily adjustable, always awesome heel wheels to transform your ordinary sneakers into the hottest way to roll.

SPECIFICATIONS:

- **Spark Pads:** Easily removable and replaceable
- **Frame:** Heavy-duty, polymer, “quick-click” with hook-and-loop strap
- **Wheels:** Proprietary, 50 mm, urethane with sealed bearings
- **Sizes:** Fits shoe sizes U.S. youth 12 through adult 12 (European youth 42 through adult 45)
- **Includes:** Spark pads and skid pads
- **Patent Pending**

RIDER TYPE:

- **Age:** 8+
- **Max Rider Weight:** 176 lb (80 kg)

COLORS:

 GR | Item#: 25056130 | UPC: 8-45423-01604-3

 PU | Item#: 25056150 | UPC: 8-45423-01603-6



No assembly required



Always check local laws to see where and how particular Razor products may be ridden. An adult's decision to permit a child to use these products should be based upon Razor's recommendations and the child's skills, maturity and the ability to follow rules. Product specifications subject to change.

DXT

Where downhill meets drift! There's no thrill too extreme for the DXT drift trike. With its full-sized steel frame, moto-style construction and 10" slick surface rear wheels, the DXT is built for edge-of-your-seat downhill drifting action, so you can let it all hang out from the freewheeling straights to the tightest curves.

SPECIFICATIONS:

- **Frame:** 2-piece, welded steel, 792 mm wide rear axle
- **Handlebars:** Moto-style flat bar
- **Grips:** Pro-style, soft, rubber
- **Clamp:** Moto-style double, aluminum
- **Fork:** Dual-crown, moto-style, sealed bearing headset
- **Brake:** V-style
- **Front Wheel:** Spoked with 20" x 2.125" pneumatic tire, internal free-wheel with cranks
- **Rear Wheels:** 10" diameter cart-style blow molded HDPE, 4" wide with slick surface, high-speed bearings, chrome-finished hub caps
- **Seat:** Adjustable (2 positions), bucket-style
- **Pedals:** BMX-style platform

RIDER TYPE:

- **Age:** 14+
- **Max Rider Weight:** 198 lb (90 kg)

COLOR:

YE | Item#: 20030501 | UPC: 8-45423-01524-4



Some assembly required



Always check local laws to see where and how particular Razor products may be ridden. An adult's decision to permit a child to use these products should be based upon Razor's recommendations and the child's skills, maturity and the ability to follow rules. Product specifications subject to change.

DELTAWING

Cleared For Take Off! The DeltaWing steps up to the next level of three-wheel action. Its drop frame, large, pneumatic front tire and low-angle, rear casters make the self-propelled DeltaWing a powerful yet smooth side-to-side ride, to shred sidewalks and carve up the pavement in style.

SPECIFICATIONS:

- **Frame:** Steel with high-tech polymer wings
- **Handlebars:** 2-piece “Y” drop
- **Grips:** Soft, rubber
- **Front Wheel:** Spoked with large 16" (406 mm) pneumatic tire
- **Rear Wheels:** Low-angle trailing casters with large 120 mm urethane wheels for drifting and spinning
- **Brake:** Hand-operated, front

RIDER TYPE:

- **Age:** 6+
- **Max Rider Weight:** 143 lb (65 kg)

COLOR:

 BK | Item#: 20036007 | UPC: 8-45423-01520-6



Some assembly required



Always check local laws to see where and how particular Razor products may be ridden. An adult's decision to permit a child to use these products should be based upon Razor's recommendations and the child's skills, maturity and the ability to follow rules. Product specifications subject to change.

POWERWING DLX

The deluxe version of the PowerWing incorporates an adjustable-height handlebar to better suit taller riders.

SPECIFICATIONS:

- **Frame:** Aluminum
- **Grips:** Foam
- **T-tube:** Adjustable-height, folding
- **Front Wheel:** Urethane
- **Rear Wheels:** Inclined casters for drifting and spinning, urethane
- **Brake:** Hand-operated, front
- **Stability Bars:** Removable

RIDER TYPE:

- **Age:** 6+
- **Max Rider Weight:** 143 lb (65 kg)

COLOR:

SL | Item#: 20036099 | UPC: 8-45423-00156-8



Some assembly required



Always check local laws to see where and how particular Razor products may be ridden. An adult's decision to permit a child to use these products should be based upon Razor's recommendations and the child's skills, maturity and the ability to follow rules. Product specifications subject to change.

POWERWING

The PowerWing ushered in a radical new way to ride. This awesome three-wheel design gets going with a side-to-side movement and allows riders to master sideways drifting and 360-degree spins.

SPECIFICATIONS:

- **Frame:** Steel main beam and high-tech polymer wings
- **Grips:** Foam
- **Front Wheel:** Urethane
- **Rear Wheels:** Inclined casters for drifting and spinning, urethane
- **Brake:** Hand-operated, front
- **Stability Bars:** Removable

RIDER TYPE:

- **Age:** 6+
- **Max Rider Weight:** 143 lb (65 kg)

COLOR:

BL | Item#: 20036003 | UPC: 8-45423-01218-2



Some assembly required



Always check local laws to see where and how particular Razor products may be ridden. An adult's decision to permit a child to use these products should be based upon Razor's recommendations and the child's skills, maturity and the ability to follow rules. Product specifications subject to change.

FLASHRIDER 360

Yet another Razor improvement on the classic three-wheeler of the 1970s, the FlashRider 360 turns and drifts on dual-inclined caster wheels and adds a Spark Bar. Now kids can spin and spark!

SPECIFICATIONS:

- **Spark Bar:** Includes replaceable spark cartridge (replacement cartridges sold separately)
- **Frame/Fork:** Welded steel
- **Handlebars:** MX-style
- **Grips:** Soft, rubber
- **Crank:** 3-piece
- **Front Tire:** Airless, flat-free
- **Rear Wheels:** Inclined casters for drifting and spinning, urethane

RIDER TYPE:

- **Age:** 6+
- **Max Rider Weight:** 160 lb (73 kg)

COLOR:



RD | Item#: 20036559 | UPC: 8-45423-01089-8



Some assembly required



Always check local laws to see where and how particular Razor products may be ridden. An adult's decision to permit a child to use these products should be based upon Razor's recommendations and the child's skills, maturity and the ability to follow rules. Product specifications subject to change.

RIPRIDER 360

Razor has a thing for reinvention, and the RipRider 360 does not disappoint. A successor to the classic three-wheeler of the 1970s, the RipRider 360 rides like no other—thanks to dual-inclined caster wheels. The casters allow resistance-free drifting and spinning action.

SPECIFICATIONS:

- **Frame/Fork:** Welded steel
- **Handlebars:** MX-style
- **Grips:** Soft, rubber
- **Crank:** 3-piece
- **Front Tire:** Airless, flat-free
- **Rear Wheels:** Inclined casters for drifting and spinning, urethane

RIDER TYPE:

- **Age:** 5+
- **Max Rider Weight:** 160 lb (73 kg)

COLOR:

BL | Item#: 20036542 | UPC: 8-45423-01091-1



Some assembly required



Always check local laws to see where and how particular Razor products may be ridden. An adult's decision to permit a child to use these products should be based upon Razor's recommendations and the child's skills, maturity and the ability to follow rules. Product specifications subject to change.

GOGO POGO

We took the pogo stick, an all-time favorite, and made it foldable and more portable. With an aluminum frame, folding foot rests and handlebars, the GoGo Pogo is a new twist on an old classic.

SPECIFICATIONS:

- **Frame:** Aluminum
- **Handlebars:** Spring-button, folding
- **Grips:** Foam
- **Spring System:** Fully enclosed with low-friction bushings
- **Foot Rests:** Folding
- **Foot Pads:** Replaceable

RIDER TYPE:

- **Age:** 6+
- **Max Rider Weight:** 140 lb (63 kg)

COLOR:

■ BK | Item#: 10068060 | UPC: 8-45423-01155-0



No assembly required



Always check local laws to see where and how particular Razor products may be ridden. An adult's decision to permit a child to use these products should be based upon Razor's recommendations and the child's skills, maturity and the ability to follow rules. Product specifications subject to change.



- E PRIME III
- E PRIME AIR
- E PRIME
- ECOSMART SUP
- ECOSMART METRO HD
- ECOSMART METRO
- E-XR
- UB1
- E300 HD
- ELECTRIC PARTY POP
- ELECTRIC TEKNO
- POWER A2
- POWER A
- POWER CORE E90 GLOW
- POWER CORE E90
- POWER CORE E100
- E100 GLOW
- E100
- E200/S
- E300/S





ELECTRIC SCOOTERS

Power to the people! Our electric-powered scooters make it easy and exciting to keep on charging. It's the awesome way to put some zip in your ride.

E PRIME III

SPECIFICATIONS:

- **Distance:** Up to 15 miles (24 km) on a single charge
- **Speed:** Up to 18 mph (29 km/h)
- **Run Time:** Up to 50 minutes of continuous use
- **Motor:** 250-watt, kick-to-start, high-torque, brushless, rear-wheel hub-driven
- **Headlight:** LED
- **Throttle:** Electronic, thumb-activated, variable-speed, paddle control
- **Brake:** Electronic, thumb-activated paddle and rear-fender controlled
- **Frame:** Aluminum
- **Fork:** Steel
- **Grips:** "Prism" design, molded in soft rubber
- **Downtube:** Aluminum, featuring patent-pending, anti-rattle, folding mechanism
- **Clamp:** Double-stacked, aluminum
- **Deck:** Length 16.5" (419 mm), width 5.5" (140 mm) with full-deck grip tape
- **Front Tire:** 8" (200 mm), pneumatic
- **Rear Tire:** 8" (200 mm), abrasion-resistant, airless, flat-free
- **Tailight/Brake Light:** LED
- **Kickstand:** Retractable
- **Battery:** 36V lithium-ion pack, rechargeable (UL2271)
- **Includes:** Security lock point, reflective decals, 5-stage LED battery indicator display and battery charger
- **Patents Pending**

RIDER TYPE:

- **Age:** 18+
- **Max Rider Weight:** 220 lb (100 kg)

COLOR:

■ GY | Item#: 13111818 | UPC: 8-45423-02316-4



**LITHIUM
POWER
TECHNOLOGY** 

**ANTI-RATTLE
TECHNOLOGY™**

Some assembly required



Always check local laws to see where and how particular Razor products may be ridden. An adult's decision to permit a child to use these products should be based upon Razor's recommendations and the child's skills, maturity and the ability to follow rules. Product specifications subject to change.

E PRIME AIR

Premium Electric Scooter. Comfort, performance, and style, the Razor E Prime Air premium electric scooter has it all! Sporting the sophisticated design and electric efficiency of the original E Prime, the E Prime Air also features a large, 8" (200 mm), pneumatic front tire that softens out rough surfaces and a sturdy aluminum frame for the smoothest ride around. Whether you're commuting to work or running errands around town (local laws will apply), we've got you covered – in comfort.

SPECIFICATIONS:

- **Distance:** Up to 7.5 miles (12 km) on a single charge
- **Speed:** Up to 15 mph (24 km/h)
- **Run Time:** Up to 40 minutes of continuous use
- **Motor:** Kick-to-start, high-torque, brushless, hub-driven
- **Throttle:** Electronic, thumb-activated, variable-speed, paddle controlled
- **Brake:** Electronic, thumb-activated paddle and rear-fender controlled
- **Frame:** Aluminum
- **Fork:** Steel with plastic fender
- **Grips:** Prism-shaped design, molded in soft rubber
- **Downtube:** Aluminum, featuring patent-pending, anti-rattle, folding mechanism
- **Clamp:** Double-stacked
- **Deck:** Length 16.75" (425 mm), width 5.5" (140 mm)
- **Front Tire:** 8" (200 mm), pneumatic
- **Rear Tire:** 8" (200 mm), abrasion-resistant, airless, flat-free
- **Handlebars:** Adjustable-height
- **Kickstand:** Retractable
- **Battery:** 36V lithium-ion pack, rechargeable (UL2271)
- **Includes:** 5-stage LED battery indicator display and battery charger

RIDER TYPE:

- **Age:** 14+
- **Max Rider Weight:** 200 lb (91 kg)

COLOR:

■ BK | Item#: 13111816 | UPC: 8-45423-02155-9

Always check local laws to see where and how particular Razor products may be ridden. An adult's decision to permit a child to use these products should be based upon Razor's recommendations and the child's skills, maturity and the ability to follow rules. Product specifications subject to change.



**LITHIUM
POWER**
TECHNOLOGY 

**ANTI-RATTLE
TECHNOLOGY™**

Some assembly required



E PRIME

The Elite Electric Scooter. Designed to impress at the office or around the neighborhood, the E Prime combines sleek style with electric efficiency to bring a new level of sophistication to every ride. Featuring a high-torque, electric hub motor, our patent-pending, anti-rattle, folding technology, taller, easy-adjust handlebars and extra-large, aluminum deck, the E Prime will have you cruising or commuting, where permitted, in style at speeds up to 15 mph (24 km/h).

SPECIFICATIONS:

- **Distance:** Up to 7.5 miles (12 km) on a single charge
- **Speed:** Up to 15 mph (24 km/h)
- **Run Time:** Up to 40 minutes of continuous use
- **Motor:** Kick-to-start, high-torque, brushless, hub-driven
- **Throttle:** Electronic, thumb-activated, variable-speed, paddle controlled
- **Brake:** Electronic, thumb-activated paddle and rear-fender controlled
- **Frame:** Aluminum
- **Fork:** One-piece billet, aluminum
- **Grips:** Prism-shaped design, molded in soft rubber
- **Downtube:** Aluminum, featuring patent-pending, anti-rattle, folding mechanism
- **Clamp:** Double-stacked
- **Deck:** Length 16.75" (425 mm), width 5.5" (140 mm)
- **Front Tire:** Extra-wide, 8" (200 mm), airless, flat-free
- **Rear Tire:** 8" (200 mm), abrasion-resistant, airless, flat-free
- **Handlebars:** Adjustable-height
- **Kickstand:** Retractable
- **Battery:** 36V lithium-ion pack, rechargeable (UL2271)
- **Includes:** 5-stage LED battery indicator display and battery charger

RIDER TYPE:

- **Age:** 14+
- **Max Rider Weight:** 176 lb (80 kg)

COLOR:

GM | Item#: 13111813 | UPC: 8-45423-02008-8

Always check local laws to see where and how particular Razor products may be ridden. An adult's decision to permit a child to use these products should be based upon Razor's recommendations and the child's skills, maturity and the ability to follow rules. Product specifications subject to change.



**LITHIUM
POWER**
TECHNOLOGY 

**3X STATIC
LOAD TESTED**

525 LB
ASTM F2641

SEE RAZOR.COM FOR DETAILS

**ANTI-RATTLE
TECHNOLOGY™**

Some assembly required



ECOSMART SUP

SPECIFICATIONS:

- **Distance:** Up to 12 miles (19 km) on a single charge
- **Speed:** Up to 15.5 mph (25 km/h)
- **Run Time:** Up to 60 minutes of continuous use
- **Motor:** 350-watt, variable-speed, high-torque, brushless, rear-wheel hub-driven
- **Throttle:** Twist-grip
- **Brake:** Hand-operated, rear
- **Frame:** Steel
- **Grips:** Soft, rubber
- **Deck:** Bamboo
- **Front Wheel:** Spoked with 16" (406 mm), pneumatic tire
- **Rear Tire:** 16" (406 mm), pneumatic
- **Kickstand:** Retractable
- **Battery:** 36V (three 12V) sealed lead-acid, rechargeable
- **Includes:** Battery charger

RIDER TYPE:

- **Age:** 16+
- **Max Rider Weight:** 220 lb (100 kg)

COLORS:

WH | Item#: 13114560 | UPC: 8-45423-02295-2

BK | Item#: 13114510 | UPC: 8-45423-02373-7



Some assembly required



Always check local laws to see where and how particular Razor products may be ridden. An adult's decision to permit a child to use these products should be based upon Razor's recommendations and the child's skills, maturity and the ability to follow rules. Product specifications subject to change.

ECOSMART METRO HD

SPECIFICATIONS:

- **Distance:** Up to 12 miles (19 km) on a single charge
- **Speed:** Up to 15.5 mph (25 km/h)
- **Run Time:** Up to 60 minutes of continuous use
- **Motor:** 350-watt, variable-speed, high-torque, brushless, rear-wheel hub-driven
- **Throttle:** Twist-grip
- **Brake:** Hand-operated, rear
- **Frame:** Steel
- **Grips:** Soft, rubber
- **Deck:** Bamboo
- **Front Wheel:** Spoked with 16" (406 mm), pneumatic tire
- **Rear Tire:** 16" (406 mm), pneumatic
- **Kickstand:** Retractable
- **Seat:** Padded
- **Storage:** Luggage rack and basket
- **Battery:** 36V (three 12V) sealed lead-acid, rechargeable
- **Includes:** Battery charger

RIDER TYPE:

- **Age:** 16+
- **Max Rider Weight:** 220 lb (100 kg)

COLOR:

■ BK | Item#: 13114508 | UPC: 8-45423-02374-4



Some assembly required



Always check local laws to see where and how particular Razor products may be ridden. An adult's decision to permit a child to use these products should be based upon Razor's recommendations and the child's skills, maturity and the ability to follow rules. Product specifications subject to change.

ECOSMART METRO

The battery-operated EcoSmart Metro electric scooter is a sleek way to get around town. With a modern design featuring a bamboo deck its perfect for trips to work, to the coffee shop, or just around the block (local laws will apply).

SPECIFICATIONS:

- **Distance:** Up to 12 miles (19 km) on a single charge
- **Speed:** Up to 18 mph (29 km/h)
- **Run Time:** Up to 40 minutes of continuous use
- **Motor:** 500-watt, variable-speed, high-torque, chain-driven
- **Throttle:** Twist-grip
- **Brake:** Hand-operated, rear
- **Frame:** Steel
- **Grips:** Soft, rubber
- **Deck:** Bamboo
- **Wheels:** Spoked with 16" (406 mm), pneumatic tires
- **Kickstand:** Retractable
- **Seat:** Padded
- **Storage:** Luggage rack and basket
- **Battery:** 36V (three 12V) sealed lead-acid, rechargeable
- **Includes:** Battery charger

RIDER TYPE:

- **Age:** 16+
- **Max Rider Weight:** 220 lb (100 kg)

COLOR:



WH | Item#: 13114501 | UPC: 8-45423-00250-3



Some assembly required



E-XR

Designed to dominate long-distance rides with the perfect balance of performance, comfort, and control, the E-XR electric scooter is Razor's most advanced personal electric scooter. Whether you're commuting to work, running errands, or hitting the town, (local laws will apply) the E-XR has you covered, with up to 16 miles (25.6 km) or up to 60 minutes of continuous use on a single charge. Ultra-durable, steel construction, and a pneumatic front tire offer an ultra-smooth ride. Experience the freedom of the Razor E-XR: for the Last Mile®.

SPECIFICATIONS:

- **Distance:** Up to 16 miles (25.6 km) on a single charge
- **Speed:** Up to 17 mph (27.4 km/h)
- **Run Time:** Up to 60 minutes of continuous use
- **Motor:** 350-watt, kick-to-start, high-torque, brushless, hub-driven
- **Headlight:** LED projection beam
- **Throttle:** Thumb-activated, variable-speed, paddle controlled
- **Brake:** Hand-operated, rear disc
- **Frame:** Heavy-duty, steel
- **Fork:** Tubular, steel
- **Grips:** Soft, rubber
- **Clamp:** Double-stacked, aluminum
- **Deck:** Length 26.2" (666 mm), width 8" (204 mm) with anti-slip rubber surface
- **Front Tire:** 9" (229 mm), pneumatic (60 PSI) commuter
- **Rear Tire:** 8" (200 mm), abrasion-resistant, airless, flat-free
- **Taillight/Brake Light:** LED
- **Kickstand:** Retractable
- **Battery:** 36V lithium-ion pack, rechargeable (UL2271)
- **Includes:** 3-stage LED battery indicator display and battery charger

RIDER TYPE:

- **Age:** 18+
- **Max Rider Weight:** 220 lb (100 kg)

COLOR:



BK | Item#: 13113618 | UPC: 8-45423-02170-2

Always check local laws to see where and how particular Razor products may be ridden. An adult's decision to permit a child to use these products should be based upon Razor's recommendations and the child's skills, maturity and the ability to follow rules. Product specifications subject to change.



Some assembly required



UB1

Take a Seat and Ride in Style. Sit back and enjoy the ride on the Razor UB1 seated electric scooter. The Razor UB1 electric scooter blends sophisticated design, portability and seated ride comfort with electric efficiency, speed, and reliability so enjoy the ride, wherever you're going. Commute in comfort (where permitted), on the Razor UB1 seated electric scooter: for the Last Mile®.

SPECIFICATIONS:

- **Speed:** Up to 13.5 mph (22 km/h)
- **Run Time:** Up to 40 minutes of continuous use
- **Motor:** 250-watt, brushless, aluminum hub-driven
- **Throttle:** Electronic, thumb-activated, variable-speed, paddle controlled
- **Brake:** Hand-operated, rear disc
- **Frame:** Aluminum with oversized downtube
- **Fork:** Stamped steel
- **Handlebars:** Folding
- **Grips:** Soft, rubber
- **Seat:** Adjustable-height, padded, suspension post with carry handle
- **Front Tire:** 8" (200 mm), pneumatic
- **Rear Tire:** Abrasion-resistant, airless, flat-free
- **Kickstand:** Retractable
- **Foot Pegs:** Folding, metal
- **Battery:** 36V lithium-ion pack, rechargeable (UL2271)
- **Includes:** Battery charger

RIDER TYPE:

- **Age:** 14+
- **Max Rider Weight:** 220 lb (100 kg)

COLOR:

■ BK | Item#: 15127016 | UPC: 8-45423-02149-8



Some assembly required



Always check local laws to see where and how particular Razor products may be ridden. An adult's decision to permit a child to use these products should be based upon Razor's recommendations and the child's skills, maturity and the ability to follow rules. Product specifications subject to change.

E300 HD

SPECIFICATIONS:

- **Distance:** Up to 10 miles (16 km) on a single charge
- **Speed:** Up to 15 mph (24 km/h)
- **Run Time:** Up to 40 minutes of continuous use
- **Motor:** 230-watt, high-torque, brushless, rear-wheel hub-driven
- **Headlight:** LED
- **Throttle:** Variable-speed, twist-grip
- **Brake:** Hand-operated, rear
- **Frame:** Steel
- **Handlebars:** Height 25" (647 mm), width 16" (420 mm)
- **Grips:** Soft, rubber
- **Clamp:** Double-stacked
- **Fork:** Tubular steel
- **Front Tire:** 9" (229 mm), pneumatic
- **Rear Tire:** 8" (200 mm), abrasion-resistant, airless, flat-free
- **Taillight/Brake Light:** LED
- **Kickstand:** Retractable
- **Battery:** 24V (two 12V) sealed lead-acid, rechargeable
- **Includes:** Battery charger

RIDER TYPE:

- **Age:** 18+
- **Max Rider Weight:** 220 lb (100 kg)

COLOR:



BK | Item#: 13113634 | UPC: 8-45423-02293-8



Some assembly required



Always check local laws to see where and how particular Razor products may be ridden. An adult's decision to permit a child to use these products should be based upon Razor's recommendations and the child's skills, maturity and the ability to follow rules. Product specifications subject to change.

ELECTRIC PARTY POP

Keep The Party Rolling! The fun doesn't stop with the Razor Electric Party Pop scooter. Featuring a unique, foot-activated pressure sensor, and light-up deck and front wheel, this lightweight, electric powered ride offers up a new way to get in the groove and bust a move at speeds up to 7.5 mph (12 km/h).

SPECIFICATIONS:

- **Speed:** Up to 7.5 mph (12 km/h)
- **Run Time:** Up to 30 minutes of continuous use
- **Motor:** 80-watt, push-to-start, high-torque hub-driven
- **Throttle:** Electronic, pressure sensor, foot-activated controlled
- **Brake:** Rear-fender with power cut-off
- **Deck:** Multi-color LED lights on and below deck
- **Frame:** Steel
- **Handlebars:** Non-folding, steel
- **Grips:** Foam
- **Front Wheel:** Light-up, urethane
- **Rear Tire:** Abrasion-resistant, airless, flat-free
- **Battery:** 10.8V lithium-ion pack, quick-charge (UL2271)
- **Includes:** Battery charger
- **Patent Pending**

RIDER TYPE:

- **Age:** 8+
- **Max Rider Weight:** 110 lb (50 kg)

COLOR:

WH | Item#: 13111710 | UPC: 8-45423-02298-3



Some assembly required



Always check local laws to see where and how particular Razor products may be ridden. An adult's decision to permit a child to use these products should be based upon Razor's recommendations and the child's skills, maturity and the ability to follow rules. Product specifications subject to change.

ELECTRIC TEKNO

Keep The Party Rolling! The fun doesn't stop with the Razor Electric Tekno scooter. Featuring a unique, foot-activated pressure sensor, and light-up deck and front wheel, this lightweight, electric powered ride offers up a new way to get in the groove and bust a move at speeds up to 7.5 mph (12 km/h).

SPECIFICATIONS:

- **Speed:** Up to 7.5 mph (12 km/h)
- **Run Time:** Up to 30 minutes of continuous use
- **Motor:** 80-watt, push-to-start, high-torque hub-driven
- **Throttle:** Electronic, pressure sensor, foot-activated controlled
- **Brake:** Rear-fender with power cut-off
- **Deck:** Multi-color LED lights on and below deck
- **Frame:** Steel
- **Handlebars:** Non-folding, steel
- **Grips:** Foam
- **Front Wheel:** Light-up, urethane
- **Rear Tire:** Abrasion-resistant, airless, flat-free
- **Battery:** 10.8V lithium-ion pack, quick-charge (UL2271)
- **Includes:** Battery charger
- **Patent Pending**

RIDER TYPE:

- **Age:** 8+
- **Max Rider Weight:** 110 lb (50 kg)

COLOR:

■ BK | Item#: 13111701 | UPC: 8-45423-02301-0



Some assembly required



Always check local laws to see where and how particular Razor products may be ridden. An adult's decision to permit a child to use these products should be based upon Razor's recommendations and the child's skills, maturity and the ability to follow rules. Product specifications subject to change.

POWER A²

Taking Performance to Another Level. Packed with innovation from its lithium-ion battery pack and push-button throttle control to its kick-to-start, in-hub electric motor, the Power A² is ushering in a new age of performance in an ultra-modern, compact and easily foldable update of our classic A scooter. Lightweight and streamlined, the Power A² packs a powered punch with bold style and a rattle-free ride at speeds up to 10 mph (16 km/h) and up to 40 minutes of continuous use.

SPECIFICATIONS:

- **Speed:** Up to 10 mph (16 km/h)
- **Run Time:** Up to 40 minutes of continuous use
- **Motor:** Kick-to-start, high-torque, hub-driven
- **Throttle:** Push-button
- **Brake:** Integrated, rear-fender with power cut-off
- **T-tube/Deck:** Aluminum
- **Handlebars:** Adjustable-height
- **Grips:** Foam
- **Downtube:** Patent-pending, anti-rattle, folding mechanism
- **Front Wheel:** Spoked, urethane
- **Rear Tire:** Abrasion-resistant, airless, flat-free
- **Kickstand:** Retractable
- **Battery:** 22V lithium-ion pack, rechargeable
- **Includes:** Battery charger
- **Patents Pending**

RIDER TYPE:

- **Age:** 8+
- **Max Rider Weight:** 143 lb (65 kg)

COLOR:

 RD | Item#: 13110002 | UPC: 8-45423-02043-9



Some assembly required

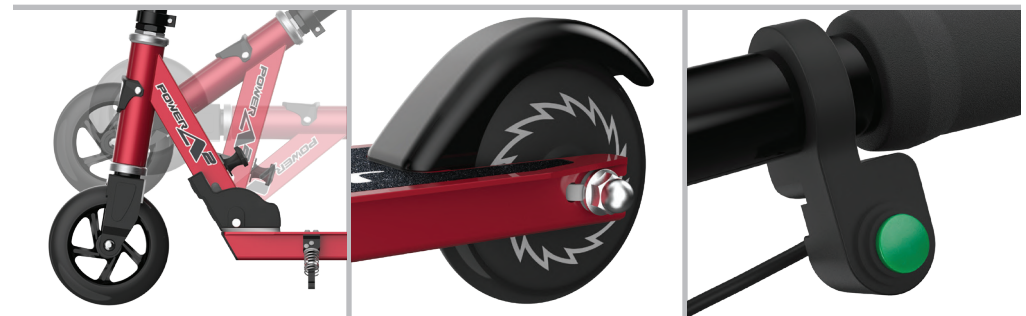

Always check local laws to see where and how particular Razor products may be ridden. An adult's decision to permit a child to use these products should be based upon Razor's recommendations and the child's skills, maturity and the ability to follow rules. Product specifications subject to change.

POWER A

The Original Reimagined. The Power A is reimagining Razor's iconic A kick scooter with the extra punch of a 100-watt, lithium-ion powered electric hub motor. Lightweight, and featuring a light-up front wheel, this electric scooter is a classic reborn for a new generation.

SPECIFICATIONS:

- **Speed:** Up to 9 mph (15 km/h)
- **Run Time:** Up to 40 minutes of continuous use
- **Motor:** 100-watt, kick-to-start, high-torque, brushless hub-driven
- **Handlebars:** Height 36" (915 mm)
- **Throttle:** Push-button
- **Grips:** Foam
- **Downtube:** Non-folding, rigid
- **Deck:** Aluminum
- **Front Wheel:** 140 mm, light-up, spoked urethane
- **Rear Tire:** Abrasion-resistant, airless, flat-free
- **Brake:** Integrated, rear-fender with power cut-off
- **Kickstand:** Retractable
- **Battery:** 22V lithium-ion pack, rechargeable (UL2271)
- **Includes:** Battery charger

RIDER TYPE:

- **Age:** 8+
- **Max Rider Weight:** 143 lb (65 kg)

COLOR:

BL | Item#: 13110041 | UPC: 8-45423-02345-4



Some assembly required



Always check local laws to see where and how particular Razor products may be ridden. An adult's decision to permit a child to use these products should be based upon Razor's recommendations and the child's skills, maturity and the ability to follow rules. Product specifications subject to change.

POWER CORE E90 GLOW

The Razor Power Core E90 Glow electric scooter is upping the ante for electric scooters once again, rolling out an awesome glow wherever you go! Just step on, kick off, and go – the lights on and below deck glow as you roll. With a high-torque, hub motor and long-lasting, 12V battery, you're good to glow for up to 60 minutes of continuous ride time at speeds up to 10 mph (16 km/h).

SPECIFICATIONS:

- **Power Core™ Technology and Design**
 - Increased ride time
 - Maintenance free (no alignment, no chain, no belt)
- **Speed:** Up to 10 mph (16 km/h)
- **Run Time:** Up to 60 minutes of continuous use
- **Motor:** 90-watt, kick-to-start, high-torque, hub-driven
- **Throttle:** Push-button
- **Brake:** Hand-operated, front
- **Frame/Fork:** Steel
- **Grips:** Foam
- **Lighting:** Includes electroluminescent wire on top of deck and 6 LEDs below deck
- **Front Wheel:** Spoked, urethane
- **Rear Tire:** Abrasion-resistant, airless, flat-free
- **Kickstand:** Retractable
- **Battery:** 12V sealed lead-acid, rechargeable
- **Includes:** Battery charger
- **U.S. and International Patents Pending**

RIDER TYPE:

- **Age:** 8+
- **Max Rider Weight:** 120 lb (54 kg)

COLOR:



RD | Item#: 13112195 | UPC: 8-45423-02147-4

Always check local laws to see where and how particular Razor products may be ridden. An adult's decision to permit a child to use these products should be based upon Razor's recommendations and the child's skills, maturity and the ability to follow rules. Product specifications subject to change.



Some assembly required



POWER CORE E90

Power Up Your Ride! The Razor Power Core E90 electric scooter is upping the ante for electric scooters once again, rolling out an amazing 80 minutes of continuous ride time! Its innovative hub motor delivers an efficient, maintenance-free ride, while the steel frame, lighter weight and increased torque take performance to the next level. Just step on, kick off, and go!

SPECIFICATIONS:

- **Power Core™ Technology and Design**
 - Increased ride time
 - Maintenance free (no alignment, no chain, no belt)
- **Speed:** Up to 10 mph (16 km/h)
- **Run Time:** Up to 80 minutes of continuous use
- **Motor:** 90-watt, kick-to-start, high-torque, hub-driven
- **Throttle:** Push-button
- **Brake:** Hand-operated, front
- **Frame/Fork:** Steel
- **Grips:** Foam
- **Front Wheel:** Spoked, urethane
- **Rear Tire:** Abrasion-resistant, airless, flat-free
- **Kickstand:** Retractable
- **Battery:** 12V sealed lead-acid, rechargeable
- **Includes:** Battery charger
- **U.S. and International Patents Pending**

RIDER TYPE:

- **Age:** 8+
- **Max Rider Weight:** 120 lb (54 kg)

COLORS:

 GR | Item#: 13111416 | UPC: 8-45423-01649-4

 PK | Item#: 13111463 | UPC: 8-45423-01646-3



Some assembly required



POWER CORE E100

Power To The Core. Enjoy the maxed-up power and longer ride time of the Razor Power Core E100 and its innovative, in-wheel hub motor. Lighter and more efficient, the maintenance-free Power Core E100, delivers 50% more torque and ride time than the Razor E100 – up to 60 minutes of continuous use at speeds up to 11 mph (18 km/h). Kick to start the high-torque hub motor, twist the throttle and see what adventure awaits.

SPECIFICATIONS:

- **Razor Power Core™ Technology and Design**
 - Maintenance free (no alignment, no chain, no belt)
 - 50% more torque than the Razor E100
- **Speed:** Up to 11 mph (18 km/h)
- **Run Time:** Up to 60 minutes of continuous use
- **Motor:** 100-watt, kick-to-start, high-torque, hub-driven
- **Throttle:** Twist-grip
- **Brake:** Hand-operated, caliper, front
- **Frame/Fork:** Steel
- **Grips:** Foam
- **Deck:** Aluminum
- **Front Tire:** 8" (200 mm), pneumatic
- **Rear Tire:** Abrasion-resistant, airless, flat-free
- **Kickstand:** Retractable
- **Battery:** 24V (two 12V) sealed lead-acid, rechargeable
- **Includes:** Battery charger
- **U.S. and International Patents Pending**

RIDER TYPE:

- **Age:** 8+
- **Max Rider Weight:** 120 lb (54 kg)

COLORS:

- BL | Item#: 13111298 | UPC: 8-45423-01961-7
- PU | Item#: 13111248 | UPC: 8-45423-02005-7
- RD | Item#: 13111288 | UPC: 8-45423-02010-1



Some assembly required



E100 GLOW

The E100 Glow streaks through the neighborhood like a bolt of blue lightning. With speeds up to 10 mph (16 km/h) and blue LEDs that light up each time you twist the throttle, the Glow transforms our best selling E100 electric scooter into an out-of-this-world ride for kids ages 8 and up.

SPECIFICATIONS:

- **Speed:** Up to 10 mph (16 km/h)
- **Run Time:** Up to 40 minutes of continuous use
- **Motor:** 100-watt, kick-to-start, high-torque, chain-driven
- **Handlebars:** Height 22" (552 mm)
- **Throttle:** Twist-grip
- **Brake:** Hand-operated, caliper, front
- **Frame/Fork:** Steel
- **Grips:** Soft, rubber
- **Deck:** Kid-sized - length 21" (530 mm), width 7" (180 mm), with blue LED glow
- **Front Tire:** 8" (200 mm), pneumatic
- **Rear Wheel:** Urethane
- **Kickstand:** Retractable
- **Battery:** 24V (two 12V) sealed lead-acid, rechargeable
- **Includes:** Battery charger

RIDER TYPE:

- **Age:** 8+
- **Max Rider Weight:** 120 lb (54 kg)

COLOR:

■ BK | Item#: 13111231 | UPC: 8-45423-01370-7



Some assembly required



Always check local laws to see where and how particular Razor products may be ridden. An adult's decision to permit a child to use these products should be based upon Razor's recommendations and the child's skills, maturity and the ability to follow rules. Product specifications subject to change.

E100

Your Ticket To Ride. The Razor E100 electric scooter is the perfect introduction to the world of electric-powered fun. Designed to help riders ages 8 and up ease into their first motorized ride, the E100 pairs a kid-sized frame with intuitive, hand-operated throttle and brake controls and a 100-watt motor – just enough speed to thrill young riders. Hop on, kick to start, twist the throttle and get a taste of the fun and freedom of an electric-powered Razor ride at speeds up to 10 mph (16 km/h).

SPECIFICATIONS:

- **Speed:** Up to 10 mph (16 km/h)
- **Run Time:** Up to 40 minutes of continuous use
- **Motor:** 100-watt, kick-to-start, high-torque, chain-driven
- **Handlebars:** Height 22" (552 mm)
- **Throttle:** Twist-grip
- **Brake:** Hand-operated, caliper, front
- **Frame/Fork:** Steel
- **Grips:** Soft, rubber
- **Deck:** Kid-sized - length 21" (530 mm), width 7" (180 mm)
- **Front Tire:** 8" (200 mm), pneumatic
- **Rear Wheel:** Urethane
- **Kickstand:** Retractable
- **Battery:** 24V (two 12V) sealed lead-acid, rechargeable
- **Includes:** Battery charger

RIDER TYPE:

- **Age:** 8+
- **Max Rider Weight:** 120 lb (54 kg)

COLORS:

 RD | Item#: 13111260 | UPC: 8-17378-00829-9

 PK | Item#: 13111261 | UPC: 8-45423-00039-4

 **SWEET PEA**
PK | Item#: 13111263 | UPC: 8-45423-00329-6



Some assembly required



Always check local laws to see where and how particular Razor products may be ridden. An adult's decision to permit a child to use these products should be based upon Razor's recommendations and the child's skills, maturity and the ability to follow rules. Product specifications subject to change.

E200/E200S

The Freedom to Go. Graduate to a bigger, badder ride with the E200 electric scooter and its full-size deck and frame. Designed for riders ages 13 and up, the E200 matches its bigger size with extra power to thrill older riders with its smooth acceleration and speeds up to 12 mph (19 km/h). With up to 40 minutes of continuous use, the E200 is perfect for a solo adventure or a cruise with friends, with the range to tackle both.

SPECIFICATIONS:

- **Speed:** Up to 12 mph (19 km/h)
- **Run Time:** Up to 40 minutes of continuous use
- **Motor:** 200-watt, high-torque, chain-driven
- **Handlebars:** Height 25" (647 mm), width 16" (420 mm)
- **Throttle:** Twist-grip
- **Brake:** Hand-operated, rear
- **Frame/Fork:** Steel
- **Grips:** Soft, rubber
- **Deck:** Full-size - length 26" (650 mm), width 8" (192 mm)
- **Tires:** 8" (200 mm), pneumatic
- **Kickstand:** Retractable
- **Battery:** 24V (two 12V) sealed lead-acid, rechargeable
- **Includes:** Battery charger
- **E200S:** Seat post and padded seat easily remove for stand-up riding

RIDER TYPE:

- **Age:** 13+
- **Max Rider Weight:** 154 lb (70 kg)

COLORS:

 **E200**
WH/RD | Item#: 13112410 | UPC: 8-45423-01972-3

 **E200S**
WH/RD | Item#: 13112758 | UPC: 8-45423-02012-5



Some assembly required



Always check local laws to see where and how particular Razor products may be ridden. An adult's decision to permit a child to use these products should be based upon Razor's recommendations and the child's skills, maturity and the ability to follow rules. Product specifications subject to change.

E300/E300S

There Goes the Neighborhood. Tears of joy or just the wind in your face, the Razor E300 electric scooter will have you zooming through the neighborhood. Top of the line and top of the speed chart, the E300's super-sized deck and frame are built for older riders and thrilling rides. Leave other rides in the dust with 250 watts of high-torque, electric punch, then turn the landscape into a blur at speeds up to 15 mph (24 km/h).

SPECIFICATIONS:

- **Speed:** Up to 15 mph (24 km/h)
- **Run Time:** Up to 40 minutes of continuous use
- **Motor:** 250-watt, high-torque, chain-driven
- **Handlebars:** Height 25" (647 mm), width 16" (420 mm)
- **Throttle:** Twist-grip
- **Brake:** Hand-operated, rear
- **Frame/Fork:** Steel
- **Grips:** Soft, rubber
- **Deck:** Super-sized - length 26.2" (666 mm), width 8" (204 mm)
- **Tires:** 9" (229 mm), pneumatic
- **Kickstand:** Retractable
- **Battery:** 24V (two 12V) sealed lead-acid, rechargeable
- **Includes:** Battery charger
- **E300S:** Seat post and padded seat easily remove for stand-up riding

RIDER TYPE:

- **Age:** 13+
- **Max Rider Weight:** 220 lb (100 kg)

COLORS:

 **E300**
WH/BL | Item#: 13113610 | UPC: 8-45423-02048-4

 **E300S**
WH/BL | Item#: 13116210 | UPC: 8-45423-02050-7

 **E300**
GY | Item#: 13113614 | UPC: 8-45423-01004-1

 **E300S**
GY | Item#: 13116214 | UPC: 8-45423-01005-8



Some assembly required



Always check local laws to see where and how particular Razor products may be ridden. An adult's decision to permit a child to use these products should be based upon Razor's recommendations and the child's skills, maturity and the ability to follow rules. Product specifications subject to change.

POCKET MOD PETITE

POCKET MOD

POCKET MOD BELLEZZA

HOVERTRAX PRIZMA

E-PUNK

ELECTRIC SKATEBOARD - DLX

ELECTRIC SKATEBOARD - CRUISER

ELECTRIC SKATEBOARD - LONGBOARD

RSF350

RSF650

CRAZY CART SHIFT

CRAZY CART

CRAZY CART XL

DXT ELECTRIC

DRIFT RIDER

POWERRIDER 360

GFD FURY

GROUND FORCE DRIFTER

GROUND FORCE





ELECTRIC RIDE-ONS

Hop on and hold on. Our innovative electric ride-ons pack a punch with thrilling rides and unique features. From the super-stylish to the wild and crazy, these high-performance, adrenaline-pumping rides set a new standard for fun on wheels.

POCKET MOD PETITE

SPECIFICATIONS:

- **Speed:** Up to 8 mph (13 km/h)
- **Run Time:** Up to 30 minutes of continuous use
- **Motor:** 100-watt, high-torque, brushless, rear-wheel hub-driven
- **Throttle:** Twist-grip
- **Brake:** Hand-operated, rear
- **Frame:** Steel
- **Fairings:** Shatter-resistant, plastic
- **Grips:** Foam
- **Front Wheel:** Spoked with 10" (255 mm), pneumatic white wall tire
- **Rear Tire:** 10" (255 mm), pneumatic, white wall
- **Kickstand:** Retractable, center
- **Battery:** 12V sealed lead-acid, rechargeable
- **Includes:** Battery charger
- **Patents Pending**

RIDER TYPE:

- **Age:** 7+
- **Max Rider Weight:** 120 lb (54 kg)

COLOR:

BL | Item#: 15130840 | UPC: 8-45423-02324-9



Some assembly required



Always check local laws to see where and how particular Razor products may be ridden. An adult's decision to permit a child to use these products should be based upon Razor's recommendations and the child's skills, maturity and the ability to follow rules. Product specifications subject to change.

POCKET MOD

The Pocket Mod gives every girl with an eye for fashion and a passion for action, a set of wheels that is sure to be the hottest ride on the block. The vintage-inspired Pocket Mod includes a storage compartment under the seat.

SPECIFICATIONS:

- **Speed:** Up to 15 mph (24 km/h)
- **Run Time:** Up to 40 minutes of continuous use
- **Motor:** High-torque, chain-driven
- **Throttle:** Twist-grip
- **Brake:** Hand-operated, rear
- **Frame:** Steel
- **Fairings:** Shatter-resistant plastic
- **Grips:** Soft, rubber
- **Wheels:** Spoked with 12" pneumatic tires
- **Kickstand:** Retractable, center
- **Storage:** Under seat
- **Battery:** 24V (two 12V) sealed lead-acid, rechargeable
- **Includes:** Battery charger
- **Sweet Pea:** Includes bell and streamers

RIDER TYPE:

- **Age:** 13+
- **Max Rider Weight:** 170 lb (77 kg)

COLORS:

BETTY
PU | Item#: 15130661 | UPC: 8-45423-00305-0

SWEET PEA
PK | Item#: 15130659 | UPC: 8-45423-00197-1



Some assembly required



Always check local laws to see where and how particular Razor products may be ridden. An adult's decision to permit a child to use these products should be based upon Razor's recommendations and the child's skills, maturity and the ability to follow rules. Product specifications subject to change.

POCKET MOD BELLEZZA

Style À La Mod! Checking in at the intersection of fashion and fun, the Pocket Mod Bellezza delivers classic Italian styling in a deluxe size. Featuring custom artwork, more legroom and up to 70 minutes of continuous ride time, this stylish electric scooter gives older riders the freedom to explore in style.

SPECIFICATIONS:

- **Speed:** Up to 16 mph (26 km/h)
- **Run Time:** Up to 70 minutes of continuous use
- **Motor:** 500-watt, high-torque, self-adjusting, chain-driven
- **Throttle:** Variable-speed, twist-grip
- **Brakes:** Hand-operated, dual disc
- **Frame:** Steel
- **Fairings:** Shatter-resistant plastic
- **Grips:** Soft, rubber
- **Wheels:** Spoked with 16" pneumatic tires
- **Kickstand:** Retractable, center
- **Storage:** Under seat
- **Battery:** 36V (three 12V) sealed lead-acid, quick-change compartment, rechargeable
- **Includes:** Battery charger

RIDER TYPE:

- **Age:** 14+
- **Max Rider Weight:** 220 lb (100 kg)

COLOR:

RD | Item#: 15130600 | UPC: 8-45423-01648-7



Always check local laws to see where and how particular Razor products may be ridden. An adult's decision to permit a child to use these products should be based upon Razor's recommendations and the child's skills, maturity and the ability to follow rules. Product specifications subject to change.

HOVERTRAX PRIZMA

SPECIFICATIONS:

- **Cruise Speed:** Up to 6 mph (10 km/h)
- **Run Time:** Up to 45 minutes of continuous use
- **Modes:** Training and Normal
- **Frame:** Steel with shatter-resistant polymer body and front multi-color LED light bars
- **Motor:** Dual, 150-watt (cruising power), 350-watt (peak power), hub cap-driven motors, with EverBalance® auto-self-balancing, gyro-sensor technology
- **Steering:** Foot-controlled, seamless maneuvering
- **Tires:** Rubber with aluminum, multi-color LED-lighted hubs
- **Foot Pads:** Anti-slip, rubber
- **Battery:** 25.2V lithium-ion pack, rechargeable
- **Includes:** Battery power indicator, balance level and mode indicator, and battery charger
- **Patent:** U.S. Patent No. 8,738,278 & RE46964 (July 24, 2018). Additional International Patents Pending

RIDER TYPE:

- **Age:** 8+
- **Max Rider Weight:** 176 lb (80 kg)



COLORS:

- BK | Item#: 15156205 | UPC: 8-45423-02327-0
- BL | Item#: 15156239 | UPC: 8-45423-02333-1
- PK | Item#: 15156257 | UPC: 8-45423-02330-0

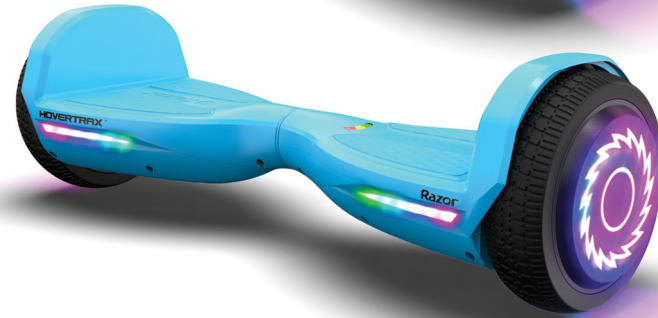

No assembly required



Always check local laws to see where and how particular Razor products may be ridden. An adult's decision to permit a child to use these products should be based upon Razor's recommendations and the child's skills, maturity and the ability to follow rules. Product specifications subject to change.

E-PUNK

Punk your ride with the Razor E-Punk – an electric-powered micro bike! Super compact and totally portable, the E-Punk is perfect for rolling and ripping around the playground, or bustin' a ride to a buddy's house. With a rigid steel frame, 8" (200 mm) pneumatic front tire, and speeds up to 9 mph (14 km/h), it's an epic ride on a micro bike!

SPECIFICATIONS:

- **Speed:** Up to 9 mph (14 km/h)
- **Run Time:** Up to 40 minutes of continuous use
- **Motor:** 90-watt, high-torque, hub-driven
- **Throttle:** Push-button
- **Brake:** Hand-operated, caliper, front
- **Frame:** Steel with oversized downtube
- **Fork:** Tubular steel
- **Handlebars:** Riser-style, padded
- **Grips:** Foam
- **Seat:** Adjustable-height, padded
- **Front Tire:** 8" (200 mm), pneumatic
- **Rear Tire:** Abrasion-resistant, airless, flat-free
- **Kickstand:** Retractable
- **Foot Pegs:** Folding, metal
- **Battery:** 12V sealed lead-acid, rechargeable
- **Includes:** Battery charger
- **Patent Pending**

RIDER TYPE:

- **Age:** 8+
- **Max Rider Weight:** 120 lb (54 kg)

COLOR:

■ BK | Item#: 15127060 | UPC: 8-45423-02087-3



Some assembly required



Always check local laws to see where and how particular Razor products may be ridden. An adult's decision to permit a child to use these products should be based upon Razor's recommendations and the child's skills, maturity and the ability to follow rules. Product specifications subject to change.

RAZORX – DLX ELECTRIC SKATEBOARD

The New Speed of Skate. This is the new era of skateboards. The 150-watt, smooth riding hub motor makes the RazorX DLX electric skateboard the leader of the pack. The wireless, digital, hand-held remote puts the thrilling electric power in the palm of your hand to help you make the flats feel like a downhill rush at speeds up to 12 mph (19 km/h).

SPECIFICATIONS:

- **Speed:** Up to 12 mph (19 km/h)
- **Run Time:** Up to 40 minutes of continuous use
- **Deck:** Length 34.25" (870 mm), twin-tip, 7-ply maple
- **Wheels:** 83 mm, 80a PU cruiser
- **Trucks:** Custom, reverse kingpin for increased turning and stability
- **Motor:** Kick-to-start, 150-watt, rear-wheel-drive, hub
- **Battery:** 22V lithium-ion battery pack, rechargeable
- **Includes:** Wireless (2.4 GHz), digital, hand-held remote with wrist strap (replaceable), LED battery indicator display, battery charger
- **US & International Patents Pending**

RIDER TYPE:

- **Age:** 9+
- **Max Rider Weight:** 220 lb (100 kg)

COLOR:



Item#: 25133090 | UPC: 8-45423-02077-4

**LITHIUM
POWER**
TECHNOLOGY 



No assembly required

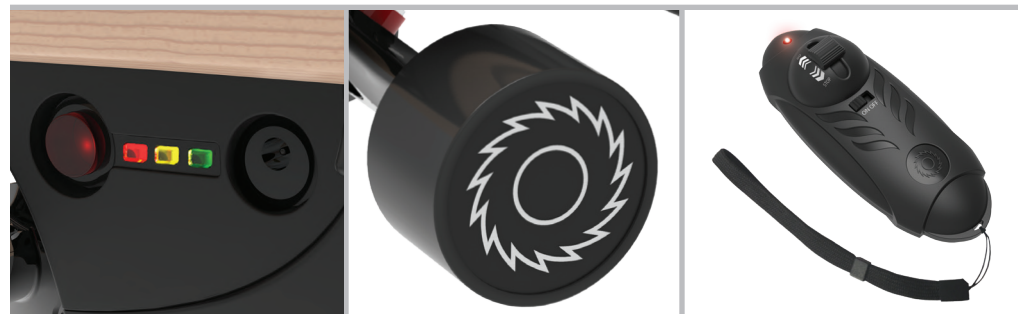

Always check local laws to see where and how particular Razor products may be ridden. An adult's decision to permit a child to use these products should be based upon Razor's recommendations and the child's skills, maturity and the ability to follow rules. Product specifications subject to change.

RAZORX – CRUISER ELECTRIC SKATEBOARD

Made To Zoom! The RazorX Cruiser is a skateboard with an electrifying kick, putting the control of the 125-watt, rear-wheel-drive motor in the palm of your hand and under your feet. Get the fun rolling with the variable-speed control on this versatile cruiser, then lean into the lithium-ion-powered, carve-and-turn skate action at speeds up to 10 mph (16 km/h).

SPECIFICATIONS:

- **Speed:** Up to 10 mph (16 km/h)
- **Run Time:** Up to 40 minutes of continuous use
- **Deck:** Length 29.7" (754 mm), 5-ply maple
- **Wheels:** 80 mm, 80a PU cruiser
- **Trucks:** Custom, reverse kingpin for increased turning and stability
- **Motor:** Kick-to-start, 125-watt, geared, rear-wheel drive (no alignment, no chain or belt)
- **Battery:** 22V lithium-ion battery pack, rechargeable (UL2271)
- **Includes:** Wireless (2.4 GHz), digital, hand-held remote with wrist strap (replaceable), battery charger
- **Patent Pending**

RIDER TYPE:

- **Age:** 9+
- **Max Rider Weight:** 220 lb (100 kg)

COLOR:



Item#: 25133099 | UPC: 8-45423-01845-0

**LITHIUM
POWER
TECHNOLOGY** 

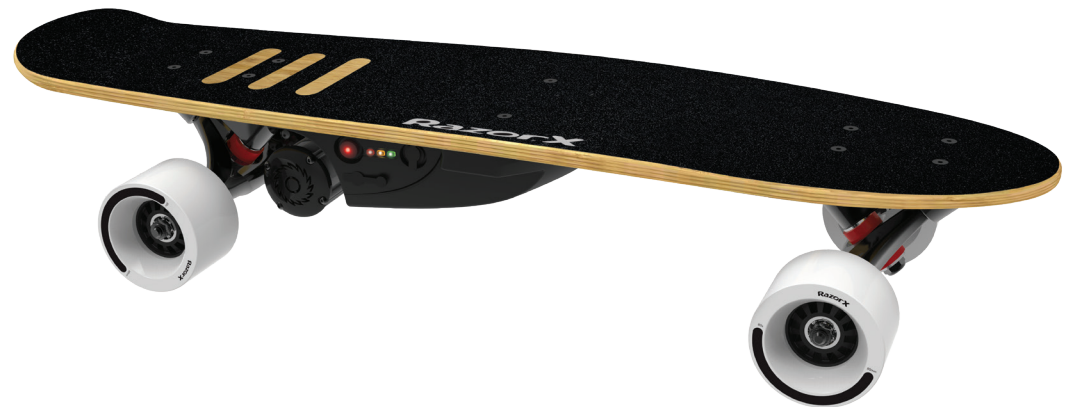

No assembly required



Always check local laws to see where and how particular Razor products may be ridden. An adult's decision to permit a child to use these products should be based upon Razor's recommendations and the child's skills, maturity and the ability to follow rules. Product specifications subject to change.

RAZORX – LONGBOARD ELECTRIC SKATEBOARD

Give Your Board A Boost! The RazorX Longboard is amping up the scene with its electric-powered, carve-and-cruise ride. Get the action started with the variable-speed, wireless, digital, hand-held remote and let the kick-to-start, 125-watt, geared, rear-wheel-drive motor keep you cruising at speeds up to 10 mph (16 km/h). It's the extra zip you need to take your ride to new lengths.

SPECIFICATIONS:

- **Speed:** Up to 10 mph (16 km/h)
- **Run Time:** Up to 40 minutes of continuous use
- **Deck:** Length 37.5" (952.5 mm), 5-ply bamboo
- **Wheels:** 80 mm, 80a PU cruiser
- **Trucks:** Custom, reverse kingpin for increased turning and stability
- **Motor:** Kick-to-start, 125-watt, geared, rear-wheel-drive (no alignment, no chain or belt)
- **Battery:** 22V lithium-ion battery pack, rechargeable (UL2271)
- **Includes:** Wireless (2.4 GHz), digital, hand-held remote with wrist strap (replaceable), battery charger
- **Patent Pending**

RIDER TYPE:

- **Age:** 9+
- **Max Rider Weight:** 220 lb (100 kg)

COLOR:

Item#: 25133098 | UPC: 8-45423-01900-6



No assembly required



RSF350

Compact Size, Big Performance! The Razor RSF350 is the hottest two-wheel sensation to hit the ground since its bigger brother, the RSF650. Powered by a high-torque, chain-driven motor and designed with authentic street-bike inspired styling, the RSF350 delivers big-time performance in a compact ride.

SPECIFICATIONS:

- **Speed:** Up to 14 mph (22 km/h)
- **Run Time:** Up to 30 minutes of continuous use
- **Motor:** High-torque, chain-driven
- **Throttle:** Twist-grip, variable-speed
- **Brake:** Hand-operated, rear disc
- **Frame:** Trellis-frame chassis design and street-bike inspired styling
- **Fork:** Double-crown
- **Fairings:** Shatter-resistant plastic
- **Handlebars:** Adjustable-angle, riser-style
- **Grips:** Soft, rubber
- **Wheels:** Custom 10" (254 mm), 3-spoke, mag wheels with pneumatic tires
- **Kickstand:** Retractable
- **Foot Pegs:** Folding, metal
- **Storage:** Hidden compartment
- **Battery:** 24V (two 12V) sealed lead-acid, rechargeable
- **Includes:** Battery charger

RIDER TYPE:

- **Age:** 13+
- **Max Rider Weight:** 140 lb (64 kg)

COLOR:



BK/RD | Item#: 15128001 | UPC: 8-45423-01899-3



Some assembly required



Always check local laws to see where and how particular Razor products may be ridden. An adult's decision to permit a child to use these products should be based upon Razor's recommendations and the child's skills, maturity and the ability to follow rules. Product specifications subject to change.

RSF650

Bold Style, Extreme Performance! Your need for speed has a new favorite ride, the RSF650. Built for high-speed performance at up to 17 mph (27 km/h), the RSF650 packs a serious punch with its authentic street-bike inspired styling, steel trellis frame and variable-speed, high-torque motor. Rev it up and let it rip for up to 50 minutes of full-throttle fun.

SPECIFICATIONS:

- **Speed:** Up to 17 mph (27 km/h)
- **Run Time:** Up to 50 minutes of continuous use
- **Motor:** 650-watt, variable-speed, high-torque, chain-driven
- **Suspension:** Rear
- **Throttle:** Twist-grip
- **Brakes:** Hand-operated, dual disc
- **Frame:** Steel trellis-frame chassis design and street-bike inspired styling with low profile windscreen
- **Fork:** Double-crown
- **Fairings:** Shatter-resistant plastic
- **Handlebars:** Adjustable-angle, riser-style
- **Grips:** Soft, rubber
- **Wheels:** Custom 12" (305 mm), 10-spoke, mag wheels with pneumatic tires
- **Kickstand:** Retractable
- **Foot Pegs:** Folding, metal
- **Storage:** Hidden compartment
- **Battery:** 36V (three 12V) sealed lead-acid, rechargeable
- **Includes:** Battery charger

RIDER TYPE:

- **Age:** 16+
- **Max Rider Weight:** 220 lb (100 kg)

COLOR:

 RD | Item#: 15128560 | UPC: 8-45423-01633-3



Some assembly required



Always check local laws to see where and how particular Razor products may be ridden. An adult's decision to permit a child to use these products should be based upon Razor's recommendations and the child's skills, maturity and the ability to follow rules. Product specifications subject to change.

CRAZY CART SHIFT

The Ultimate Drifting Machine for younger kids! Now kids as young as six years old can drive, drift, and spin like never before, with the electric powered Crazy Cart® Shift™ from Razor! Featuring a new, smaller frame, simplified drift system, and a hidden parent-controlled speed switch, the Shift's design has been tailored to the size and skill level of younger drivers. Drift into fun, with the all new Crazy Cart Shift.

SPECIFICATIONS:

- **Speed:** Variable-speed acceleration up to 8 mph (13 km/h) in the default HIGH speed setting. A hidden Parental Speed Control switch allows parents to limit their child's Crazy Cart Shift to a top speed of 2.5 mph (4 km/h) for younger drivers and beginners.
- **Run Time:** Up to 40 minutes of continuous use in default HIGH speed mode, up to 80 minutes of continuous use when Parental-controlled Speed switch is set to the optional LOW speed mode
- **Power Core™ Hub Motor Technology**
 - 90-watt, high-torque, hub-driven
 - Maintenance Free (no alignment, no chain, no belt)
 - Patents Pending
- **Throttle:** Variable-speed, foot pedal
- **Frame:** Uni-body construction, high-impact polymer
- **Steering:** Steer-to-drift. Uses the steering wheel to drift like a real car. Allows young drivers to keep both hands on the wheel for stability
- **Front Tire:** 6" (152 mm), abrasion-resistant, airless, flat-free
- **Rear Wheels:** Urethane with inclined casters
- **Seat:** Bucket-style
- **Battery:** 12V sealed lead-acid, rechargeable
- **Includes:** Battery charger and flag
- **Patent Pending**

RIDER TYPE:

- **Age:** 6+
- **Max Rider Weight:** 120 lb (54 kg)

COLOR:

 BL | Item#: 25143444 | UPC: 8-45423-02145-0



No assembly required



Always check local laws to see where and how particular Razor products may be ridden. An adult's decision to permit a child to use these products should be based upon Razor's recommendations and the child's skills, maturity and the ability to follow rules. Product specifications subject to change.

CRAZY CART

The Ultimate Drifting Machine. Drive, spin, or drift like a pro. Performs like a go-cart or kicks into Crazy Cart mode with the lift of the Drift Bar. Patented drift system allows drivers to vary the rear caster angle so they can drive and drift forward, backward, sideways, diagonally, and everything in between!

SPECIFICATIONS:

- **Speed:** Up to 12 mph (19 km/h)
- **Run Time:** Up to 40 minutes of continuous use
- **Motor:** High-torque, chain-driven
- **Throttle:** Variable-speed, foot pedal
- **Frame:** Powder-coated steel
- **Steering:** 1:1 steering ratio for ultimate responsiveness
- **Front Tire:** 8" (200 mm), pneumatic
- **Rear Wheels:** Urethane with inclined casters
- **Seat:** Bucket-style
- **Battery:** 24V (two 12V) sealed lead-acid, rechargeable
- **Includes:** Battery charger, flag (not shown) and front stabilizer posts

RIDER TYPE:

- **Age:** 9+
- **Max Rider Weight:** 140 lb (63 kg)

COLOR:



BK | Item#: 25143490 | UPC: 8-45423-00795-9



No assembly required



Always check local laws to see where and how particular Razor products may be ridden. An adult's decision to permit a child to use these products should be based upon Razor's recommendations and the child's skills, maturity and the ability to follow rules. Product specifications subject to change.

CRAZY CART XL

The Ultimate Drifting Machine just grew up! In response to the overwhelming demand for an adult-sized version of our award-winning Crazy Cart, Razor presents the Crazy Cart XL: a full-size, high-powered drift cart for the kid in all of us!

SPECIFICATIONS:

- **Speed:** Up to 14 mph (23 km/h)
- **Run Time:** Up to 40 minutes of continuous use
- **Motor:** Extra high-torque, chain-driven
- **Throttle:** Variable-speed, foot pedal
- **Frame:** Powder-coated steel
- **Steering:** Patented, allows unique drifting, turning and stopping
- **Front Tires/Wheels:** 8" (200 mm) pneumatic and caster, urethane
- **Rear Wheels:** Dual-inclined caster, urethane
- **Seat:** Raised, bucket-style
- **Battery:** 36V (three 12V) sealed lead-acid, quick-change compartment, rechargeable
- **Includes:** Battery charger and flag (not shown)

RIDER TYPE:

- **Age:** 16+
- **Max Rider Weight:** 240 lb (109 kg)

COLOR:

 BK | Item#: 25143401 | UPC: 8-45423-01427-8



No assembly required



Always check local laws to see where and how particular Razor products may be ridden. An adult's decision to permit a child to use these products should be based upon Razor's recommendations and the child's skills, maturity and the ability to follow rules. Product specifications subject to change.

DXT ELECTRIC

Full Throttle Drift! Take the edge-of-your-seat drifting action out of the hills and into the flats with the Razor DXT Electric. With its high-torque, 500-watt motor, moto-style construction and 10" slick surface rear wheels, the DXT Electric delivers full-throttle thrills at speeds up to 15 mph (24 km/h). Push the limits and feel the g's with this extreme, side-sliding ride.

SPECIFICATIONS:

- **Speed:** Up to 15 mph (24 km/h)
- **Run Time:** Up to 60 minutes of continuous use
- **Motor:** 500-watt, high-torque, chain-driven
- **Throttle:** Twist-grip
- **Brake:** Hand-operated, front disc
- **Frame:** 2-piece welded steel, 36" wide rear axle
- **Fork:** Dual-crown moto-style, sealed bearing headset
- **Handlebars:** Moto-style flat bar, alloy
- **Grips:** Pro-style, soft, rubber
- **Clamp:** Moto-style double, alloy
- **Front Wheel:** Pneumatic tire with 16" x 2.125" heavy-duty steel rim
- **Rear Wheels:** 10" diameter cart-style pneumatic with POM (removable/replaceable) sleeves, 4" wide slick surface, high-speed bearings
- **Seat:** Adjustable (2 positions), bucket-style
- **Foot Pegs:** Folding, adjustable, metal
- **Battery:** 36V (three 12V) sealed lead-acid, quick-change compartment, rechargeable
- **Includes:** Battery charger, flag (not shown)

RIDER TYPE:

- **Age:** 16+
- **Max Rider Weight:** 198 lb (90 kg)

COLOR:

 BK | Item#: 20130599 | UPC: 8-45423-01650-0



Some assembly required



Always check local laws to see where and how particular Razor products may be ridden. An adult's decision to permit a child to use these products should be based upon Razor's recommendations and the child's skills, maturity and the ability to follow rules. Product specifications subject to change.

DRIFT RIDER

Full Power Drift. Moto-inspired style meets edge-of-your-seat drifting action with the Drift Rider electric drift cycle. Twist the throttle to feel the power of the 100-watt, electric hub motor, then kick the action into high gear by kicking the back end out for some wild, freestyle drifting fun at speeds up to 9 mph (14 km/h). It's a one-of-a-kind, power-sliding ride that is sure to get your adrenaline pumping.

SPECIFICATIONS:

- **Speed:** Up to 9 mph (14 km/h)
- **Run Time:** Up to 40 minutes of continuous use
- **Motor:** 100-watt, high-torque, direct-drive hub
- **Throttle:** Twist-grip, variable-speed
- **Brake:** Hand-operated, front
- **Frame:** Steel, torsion
- **Fork:** Double-crown
- **Fairings:** Shatter-resistant polymer
- **Handlebars:** Riser-style
- **Grips:** Soft, rubber
- **Front Tire:** Abrasion-resistant, airless, flat-free
- **Rear Wheels:** Dual-inclined, urethane caster wheels for drifting and spinning
- **Foot Pads:** Rubber
- **Battery:** 22V lithium-ion pack, rechargeable
- **Includes:** Battery charger and flag (not shown)
- **US and International Patents Pending**

RIDER TYPE:

- **Age:** 9+
- **Max Rider Weight:** 143 lb (65 kg)

COLOR:



RD | Item#: 20111917 | UPC: 8-45423-02041-5



Some assembly required



Always check local laws to see where and how particular Razor products may be ridden. An adult's decision to permit a child to use these products should be based upon Razor's recommendations and the child's skills, maturity and the ability to follow rules. Product specifications subject to change.

POWERRIDER 360

Blast into the future with the PowerRider 360 – the electric-powered three-wheeler from Razor! With the push of a button, it's off – no pedaling required. Races at speeds up to 9 mph (14 km/h), cuts full 360-degree spins, slides, even drifts on the PowerRider 360's high-performance, dual-inclined, rear caster wheels. It's a 360° ride electrified!

SPECIFICATIONS:

- **Speed:** Up to 9 mph (14 km/h)
- **Run Time:** Up to 30 minutes of continuous use
- **Motor:** High-torque, chain-driven
- **Throttle:** Push-button
- **Brake:** Hand-operated, front
- **Frame/Fork:** Welded steel
- **Handlebars:** MX-style double crown design
- **Grips:** Soft, rubber
- **Front Tire:** 8" (200 mm), pneumatic
- **Rear Wheels:** Dual-inclined caster wheels for drifting and spinning, urethane
- **Foot Pegs:** Folding, metal
- **Battery:** 12V sealed lead-acid, rechargeable
- **Includes:** Battery charger and flag (not shown)

RIDER TYPE:

- **Age:** 8+
- **Max Rider Weight:** 120 lb (54 kg)

COLOR:



BK/YL | Item#: 20136401 | UPC: 8-45423-01350-9



Some assembly required



Always check local laws to see where and how particular Razor products may be ridden. An adult's decision to permit a child to use these products should be based upon Razor's recommendations and the child's skills, maturity and the ability to follow rules. Product specifications subject to change.

GFD FURY

Fast Drifts, Furious Sparks! Features the same go-cart style frame and Super Slider™ POM rear wheels as the Ground Force Drifter. The GFD Fury ups the ante with the added flash of its unique Spark Bar that leaves a shower of sparks in its wake.

SPECIFICATIONS:

- **Spark Bar:** Includes replaceable spark cartridge
- **Speed:** Up to 12 mph (19 km/h)
- **Run Time:** Up to 40 minutes of continuous use
- **Motor:** High-torque, chain-driven
- **Throttle:** Variable-speed, thumb trigger
- **Brake:** Hand-operated, rear
- **Frame:** Powder-coated steel
- **Front Wheels:** Molded aluminum with solid rubber tires
- **Rear Wheels:** Super Slider™ POM
- **Seat:** Bucket-style with seat/shoulder strap
- **Battery:** 24V (two 12V) sealed lead-acid, rechargeable
- **Includes:** Battery charger and flag (not shown)

RIDER TYPE:

- **Age:** 8+
- **Max Rider Weight:** 140 lb (64 kg)

COLOR:

WH | Item#: 25143480 | 8-45423-01527-5



Some assembly required



Always check local laws to see where and how particular Razor products may be ridden. An adult's decision to permit a child to use these products should be based upon Razor's recommendations and the child's skills, maturity and the ability to follow rules. Product specifications subject to change.

GROUND FORCE DRIFTER

Fast, Furious, and Cool! The Ground Force Drifter has a steel go-cart style frame combined with Super Slider™ POM rear wheels! Riders can power slide through corners, throw fish tails or fast 180s!

SPECIFICATIONS:

- **Speed:** Up to 12 mph (19 km/h)
- **Run Time:** Up to 40 minutes of continuous use
- **Motor:** High-torque, chain-driven
- **Throttle:** Variable-speed, thumb trigger
- **Brake:** Hand-operated, rear
- **Frame:** Powder-coated steel
- **Front Wheels:** Molded aluminum with solid rubber tires
- **Rear Wheels:** Super Slider™ POM
- **Seat:** Bucket-style with seat/shoulder strap
- **Battery:** 24V (two 12V) sealed lead-acid, rechargeable
- **Includes:** Battery charger and flag (not shown)

RIDER TYPE:

- **Age:** 8+
- **Max Rider Weight:** 140 lb (64 kg)

COLOR:

BL | Item#: 25143400 | UPC: 8-45423-00187-2



Some assembly required



Always check local laws to see where and how particular Razor products may be ridden. An adult's decision to permit a child to use these products should be based upon Razor's recommendations and the child's skills, maturity and the ability to follow rules. Product specifications subject to change.

GROUND FORCE

Go-Cart Racing Is Cool! The Ground Force has combined classic cart-styling, low-profile and sturdy steel construction with great maneuverability and enhanced steering.

SPECIFICATIONS:

- **Speed:** Up to 12 mph (19 km/h)
- **Run Time:** Up to 40 minutes of continuous use
- **Motor:** High-torque, chain-driven
- **Throttle:** Variable-speed, thumb trigger
- **Brake:** Hand-operated, rear
- **Frame:** Powder-coated steel
- **Wheels:** Molded aluminum with solid rubber tires
- **Seat:** Bucket-style with seat/shoulder strap
- **Battery:** 24V (two 12V) sealed lead-acid, rechargeable
- **Includes:** Battery charger and flag (not shown)

RIDER TYPE:

- **Age:** 8+
- **Max Rider Weight:** 140 lb (64 kg)

COLOR:

SL | Item#: 300001-SL | UPC: 8-45423-00323-4



Some assembly required



Always check local laws to see where and how particular Razor products may be ridden. An adult's decision to permit a child to use these products should be based upon Razor's recommendations and the child's skills, maturity and the ability to follow rules. Product specifications subject to change.



SX350 MCGRATH

SX500 MCGRATH

MX650

MX500

MX350

DIRT QUAD 500

DIRT QUAD

DUNE BUGGY

RX200

RDS





DIRT

Leave the pavement behind. Our line-up of off-road rides are turning the great outdoors into your personal playground. Built to withstand the punishment of tough trails and rough terrain, these hard-charging, dirt-blasting rides leave the competition in the dust.

SX350 MCGRATH

The Next King Of Dirt. What better way to get your start on dirt than with the winningest supercross rider in history, Jeremy McGrath. The SX350 McGrath scales Jeremy's iconic bike down to size for younger riders, featuring authentic MX-frame geometry, motocross-spec tires and rear brake for a true to life ride. It's the perfect start for the next generation of motocross riders.



Jeremy McGrath

SPECIFICATIONS:

- **Authentic Jeremy McGrath graphics and fairing design**
- **Speed:** Up to 14 mph (22 km/h)
- **Run Time:** Up to 30 minutes of continuous use
- **Motor:** High-torque, chain-driven
- **Throttle:** Twist-grip
- **Brake:** Hand-operated, rear
- **Frame:** Steel with authentic dirt bike geometry
- **Fork:** Double-crown
- **Fairings:** Shatter-resistant plastic
- **Handlebars:** Adjustable-angle, riser-style
- **Grips:** Soft, rubber
- **Wheels:** Spoked with 12" pneumatic, knobby tires
- **Kickstand:** Retractable
- **Foot Pegs:** Folding, metal
- **Battery:** 24V (two 12V) sealed lead-acid, rechargeable
- **Includes:** Battery charger

RIDER TYPE:

- **Age:** 13+
- **Max Rider Weight:** 140 lb (64 kg)

COLOR:

GR | Item#: 15128034 | UPC: 8-45423-02079-8



Some assembly required



Always check local laws to see where and how particular Razor products may be ridden. An adult's decision to permit a child to use these products should be based upon Razor's recommendations and the child's skills, maturity and the ability to follow rules. Product specifications subject to change.

SX500 MCGRATH

It's Showtime! What do you get when you combine the winningest motocross rider in history and the Razor product-making machine? The SX500 McGrath! With authentic MX frame geometry and faithful reproduction of Jeremy's big bike, we offer you the perfect product for little champions! Motorcycle-spec tires with front- and rear-specific tread, disc brakes and dual suspension make this electric ride ready to rock the dirt.

SPECIFICATIONS:

- **Authentic Jeremy McGrath graphics and fairing design**
- **Speed:** Up to 15 mph (24 km/h)
- **Run Time:** Up to 40 minutes of continuous use
- **Motor:** Variable-speed, high-torque, chain-driven
- **Suspension:** Dual
- **Throttle:** Twist-grip
- **Brakes:** Hand-operated, dual disc
- **Frame:** Steel
- **Fork:** Double-crown
- **Fairings:** Shatter-resistant plastic
- **Handlebars:** Adjustable-angle, riser-style
- **Grips:** Soft, rubber
- **Wheels:** Spoked with motorcycle-spec tires with front- and rear-specific tread
- **Kickstand:** Retractable
- **Foot Pegs:** Folding, metal
- **Battery:** 36V (three 12V) sealed lead-acid, rechargeable
- **Includes:** Battery charger

RIDER TYPE:

- **Age:** 14+
- **Max Rider Weight:** 175 lb (79 kg)

COLOR:

 GR | Item#: 15128130 | UPC: 8-45423-01840-5



Some assembly required



Always check local laws to see where and how particular Razor products may be ridden. An adult's decision to permit a child to use these products should be based upon Razor's recommendations and the child's skills, maturity and the ability to follow rules. Product specifications subject to change.

MX650

This high-performance, electric-powered dirt bike comes equipped with supercross-inspired styling, a high-torque motor, dual suspension, and disc brakes. Designed to generate more power for uphill and off-road conditions, the MX650 is ready to rumble.

SPECIFICATIONS:

- **Speed:** Up to 17 mph (27 km/h)
- **Run Time:** Up to 40 minutes of continuous use
- **Motor:** Variable-speed, high-torque, chain-driven
- **Suspension:** Dual
- **Throttle:** Twist-grip
- **Brakes:** Hand-operated, dual disc
- **Frame:** Steel with authentic dirt bike geometry
- **Fork:** Double-crown
- **Fairings:** Shatter-resistant plastic
- **Handlebars:** Adjustable-angle, riser-style
- **Grips:** Soft, rubber
- **Wheels:** Spoked with 16" front and 14" rear pneumatic, knobby tires
- **Kickstand:** Retractable
- **Foot Pegs:** Folding, metal
- **Battery:** 36V (three 12V) sealed lead-acid, rechargeable
- **Includes:** Battery charger

RIDER TYPE:

- **Age:** 16+
- **Max Rider Weight:** 220 lb (100 kg)

COLOR:

YE | Item#: 15165070 | UPC: 8-17378-00952-4



Some assembly required



Always check local laws to see where and how particular Razor products may be ridden. An adult's decision to permit a child to use these products should be based upon Razor's recommendations and the child's skills, maturity and the ability to follow rules. Product specifications subject to change.

MX500

Riding the Dirt Rocket MX500 is one way to feel like a motocross superstar. Authentic dirt bike frame geometry, large pneumatic tires and a high-torque, variable-speed motor deliver a super-charged off-road experience.

SPECIFICATIONS:

- **Speed:** Up to 15 mph (24 km/h)
- **Run Time:** Up to 40 minutes of continuous use
- **Motor:** Variable-speed, high-torque, chain-driven
- **Suspension:** Dual
- **Throttle:** Twist-grip
- **Brakes:** Hand-operated, dual disc
- **Frame:** Steel with authentic dirt bike geometry
- **Fork:** Double-crown
- **Fairings:** Shatter-resistant plastic
- **Handlebars:** Adjustable-angle, riser-style
- **Grips:** Soft, rubber
- **Wheels:** Spoked with 16" front and 14" rear pneumatic, knobby tires
- **Kickstand:** Retractable
- **Foot Pegs:** Folding, metal
- **Battery:** 36V (three 12V) sealed lead-acid, rechargeable
- **Includes:** Battery charger

RIDER TYPE:

- **Age:** 14+
- **Max Rider Weight:** 175 lb (79 kg)

COLOR:

 RD | Item#: 15128190 | UPC: 8-17378-00954-8



Some assembly required



Always check local laws to see where and how particular Razor products may be ridden. An adult's decision to permit a child to use these products should be based upon Razor's recommendations and the child's skills, maturity and the ability to follow rules. Product specifications subject to change.

MX350

The Dirt Rocket MX350 is a scaled-down, electric-powered dirt bike that lets riders live out their off-road fantasies. The MX350 has large, knobby tires, and a chain-driven motor that deliver top-notch performance.

SPECIFICATIONS:

- **Speed:** Up to 14 mph (22 km/h)
- **Run Time:** Up to 30 minutes of continuous use
- **Motor:** High-torque, chain-driven
- **Throttle:** Twist-grip
- **Brake:** Hand-operated, rear
- **Frame:** Steel with authentic dirt bike geometry
- **Fork:** Double-crown
- **Fairings:** Shatter-resistant plastic
- **Handlebars:** Adjustable-angle, riser-style
- **Grips:** Soft, rubber
- **Wheels:** Spoked with 12" pneumatic, knobby tires
- **Kickstand:** Retractable
- **Foot Pegs:** Folding, metal
- **Battery:** 24V (two 12V) sealed lead-acid, rechargeable
- **Includes:** Battery charger

RIDER TYPE:

- **Age:** 13+
- **Max Rider Weight:** 140 lb (64 kg)

COLOR:

BL | Item#: 15128040 | UPC: 8-45423-00134-6



Some assembly required



Always check local laws to see where and how particular Razor products may be ridden. An adult's decision to permit a child to use these products should be based upon Razor's recommendations and the child's skills, maturity and the ability to follow rules. Product specifications subject to change.

DIRT QUAD 500

Domination On Dirt! Big enough to tackle rugged off-road terrain, this grown-up, pumped-up version of our Dirt Quad is ready and able to get your adrenaline rushing. Its authentic moto-styling, larger frame and high-torque motor make this the perfect step up in size and adventure for older riders.

SPECIFICATIONS:

- **Run Time:** Up to 60 minutes of continuous use
- **Motor:** 500-watt, high-torque, internal/integral gear set, self-adjusting chain-driven
- **Suspension:** Fully active rear suspension for increased traction
- **Throttle:** Variable-speed, twist-grip
- **Brake:** Hand-operated, rear disc
- **Frame:** Powder-coated tubular steel for all-weather durability with front brush bar and rear carry handle
- **Fairings:** Shatter-resistant plastic
- **Handlebars:** Adjustable-height, riser-style
- **Grips:** Soft, rubber
- **Wheels:** Steel with front and rear specific (size and tread) pneumatic tires
- **Space saving vertical storage capability**
- **Battery:** 36V (three 12V) sealed lead-acid, quick-change compartment, rechargeable
- **Includes:** Battery charger

RIDER TYPE:

- **Age:** 14+
- **Max Rider Weight:** 220 lb (100 kg)

COLOR:

WH | Item#: 25143000 | UPC: 8-45423-01634-0



Some assembly required

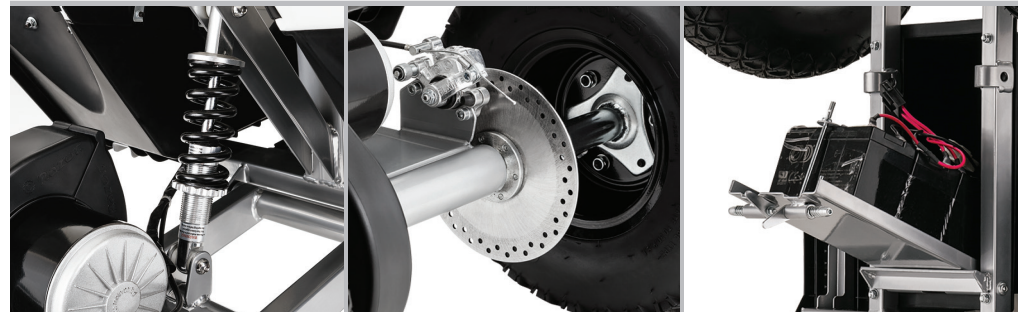

Always check local laws to see where and how particular Razor products may be ridden. An adult's decision to permit a child to use these products should be based upon Razor's recommendations and the child's skills, maturity and the ability to follow rules. Product specifications subject to change.

DIRT QUAD

When the backyard becomes too groomed and the pavement too smooth, the four-wheel Dirt Quad offers unlimited adventure – and it's built strong and sturdy to conquer tough trails and big bumps.

SPECIFICATIONS:

- **Run Time:** Up to 40 minutes of continuous use
- **Motor:** High-torque, gear reduction, chain-driven
- **Suspension:** Rear droop travel with coil shock
- **Throttle:** Variable-speed, twist-grip
- **Brake:** Hand-operated, rear disc
- **Frame:** Powder-coated, tubular steel for all-weather durability with front brush bar and rear carry handle
- **Fairings:** Shatter-resistant plastic
- **Handlebars:** Adjustable-height, riser-style
- **Grips:** Soft, rubber
- **Wheels:** Steel with 12" knobby, pneumatic tires
- **Space saving vertical storage capability**
- **Battery:** 24V (two 12V) sealed lead-acid, rechargeable
- **Includes:** Battery charger

RIDER TYPE:

- **Age:** 8+
- **Max Rider Weight:** 120 lb (54 kg)

COLOR:

■ BK | Item#: 25143002 | UPC: 8-45423-01349-3



Some assembly required



Always check local laws to see where and how particular Razor products may be ridden. An adult's decision to permit a child to use these products should be based upon Razor's recommendations and the child's skills, maturity and the ability to follow rules. Product specifications subject to change.

DUNE BUGGY

The classic Dune Buggy design features a bucket-style seat and diamond plate floorboard with knobby tires and terrain-following rear suspension – the dunes will be begging for mercy.

SPECIFICATIONS:

- **Speed:** Up to 9 mph (14 km/h)
- **Run Time:** Up to 40 minutes of continuous use
- **Motor:** Variable-speed, high-torque, chain-driven
- **Suspension:** Terrain following, rear
- **Throttle:** Thumb trigger
- **Brake:** Hand-operated, rear disc
- **Frame:** Steel
- **Wheels:** Steel with 8" knobby, pneumatic tires
- **Seat:** Bucket-style with seat/shoulder strap
- **Battery:** 24V (two 12V) sealed lead-acid, rechargeable
- **Includes:** Battery charger and flag (not shown)

RIDER TYPE:

- **Age:** 8+
- **Max Rider Weight:** 120 lb (54 kg)

COLOR:

 RD | Item#: 25143511 | UPC: 8-45423-00320-3



Some assembly required



Always check local laws to see where and how particular Razor products may be ridden. An adult's decision to permit a child to use these products should be based upon Razor's recommendations and the child's skills, maturity and the ability to follow rules. Product specifications subject to change.

RX200

With the trailblazing RX200, the ride begins where the pavement ends. Beefed up to withstand tough terrain, the RX200 features off-road tires, disc brake and a high-torque gear ratio for trail riding, making it off-road ready right out of the gate.

SPECIFICATIONS:

- **Speed:** Up to 12 mph (19 km/h)
- **Run Time:** Up to 40 minutes of continuous use
- **Motor:** Chain-driven, high-torque gear ratio for trail use
- **Drivetrain:** Rear sprocket with freewheel for coasting
- **Throttle:** Twist-grip
- **Brake:** Hand-operated, rear disc
- **Frame/Fork:** Steel
- **Handlebars:** Riser-style
- **Grips:** Soft, rubber
- **Clamp:** Triple-stacked
- **Grip Tape:** Full-deck
- **Wheels:** Heavy-duty alloy with 60 PSI on/off road pneumatic tires
- **Kickstand:** Retractable
- **Battery:** 24V (two 12V) sealed lead-acid, rechargeable
- **Includes:** Battery charger

RIDER TYPE:

- **Age:** 13+
- **Max Rider Weight:** 154 lb (70 kg)

COLOR:

GR | Item#: 13112401 | UPC: 8-45423-01529-9



Some assembly required



Always check local laws to see where and how particular Razor products may be ridden. An adult's decision to permit a child to use these products should be based upon Razor's recommendations and the child's skills, maturity and the ability to follow rules. Product specifications subject to change.

RDS

The scooter is no longer restricted to pavement! The Razor Dirt Scooter (RDS) proves that off-road scooter riding is just as much fun, with a heavy-duty aluminum frame and wheels, and tires made specifically for tackling dirt.

SPECIFICATIONS:

- **Frame:** Aluminum
- **Handlebar:** Width 19.5" (495 mm), height 20" (510 mm), fixed riser Y-style
- **Grips:** Soft, rubber
- **Clamp:** Triple-stacked
- **Fork:** Tubular BMX-style, steel
- **Wheels:** Molded Nylon 6 (PA 6) hubs with 60 psi, 8" (200 mm), pneumatic tires with aggressive tread pattern
- **Deck:** Width 4.75" (120 mm), length 20.75" (530 mm)
- **Grip Tape:** Full-deck
- **Brake:** Rear-fender

RIDER TYPE:

- **Age:** 10+
- **Max Rider Weight:** 220 lb (100 kg) for Normal Riding
- **Max Rider Weight:** 120 lb (54 kg) for Aggressive Riding

COLOR:



RD | Item#: 13018158 | UPC: 8-45423-01210-6



Some assembly required



Always check local laws to see where and how particular Razor products may be ridden. An adult's decision to permit a child to use these products should be based upon Razor's recommendations and the child's skills, maturity and the ability to follow rules. Product specifications subject to change.

- SPECIAL EDITION – PIZZA & FRIES
- SPECIAL EDITION – BLACK & WHITE
- CLASSIC
- CLASSIC – BRIGHTS
- G
- RIPSTER
- RIPSURF





RIPSTIK

Twist and go! There's nothing quite like the feeling of riding a RipStik caster board. It's like carving through waves or snow – but on dry land!

A pivoting deck and innovative 360-degree casters are the secret behind the craze. Rip it!

SPECIAL EDITION - FOOD FIGHT

Carve Your Appetite for Fun. What do you get when you combine surf, skate and a tasty food court? The most mouth-watering Razor RipStik in history. Top of the line, and top of the food chain, the Special Edition Food Fight RipStiks take our classic twist and carve ride and add a serious side of tasty fast-food style with foodie fan favorites Pizza and Fries. With all the awesome of a surfboard, a snowboard, and a skateboard at your feet - your toes and your taste buds are in for a treat.

SPECIFICATIONS:

- **Deck:** High-tech polymer with removable deck plates
- **Platform:** Slip-resistant, concave, pivoting deck
- **Torsion Bar:** Rubber-padded steel
- **Wheels:** High-grade urethane on inclined, 360-degree casters

RIDER TYPE:

- **Age:** 8+
- **Max Rider Weight:** 220 lb (100 kg)

COLORS:

 Fries | Item#: 15055026 | UPC: 8-45423-02045-3

 Pizza | Item#: 15055022 | UPC: 8-45423-02044-6



No assembly required



Always check local laws to see where and how particular Razor products may be ridden. An adult's decision to permit a child to use these products should be based upon Razor's recommendations and the child's skills, maturity and the ability to follow rules. Product specifications subject to change.

SPECIAL EDITION - BLACK & WHITE

All the features of the Classic, in Special Edition deckplate designs. Each of the edgy, black and white graphics was illustrated by an artist specifically for the RipStik.

SPECIFICATIONS:

- **Deck:** High-tech polymer with removable deck plates
- **Platform:** Slip-resistant, concave, pivoting deck
- **Torsion Bar:** Rubber-padded steel
- **Wheels:** High-grade urethane on inclined, 360-degree casters

RIDER TYPE:

- **Age:** 8+
- **Max Rider Weight:** 220 lb (100 kg)

COLORS:

▲ Serpent | Item#: 15055007 | UPC: 8-17378-00642-6

▲ Crow | Item#: 15055012 | UPC: 8-17378-00643-3

▲ Battle | Item#: 15055015 | UPC: 8-17378-00644-0



No assembly required



Always check local laws to see where and how particular Razor products may be ridden. An adult's decision to permit a child to use these products should be based upon Razor's recommendations and the child's skills, maturity and the ability to follow rules. Product specifications subject to change.

CLASSIC

The RipStik caster board is like surfing or snowboarding on dry land. The RipStik's 360-degree, inclined casters and pivoting deck move the rider forward with a unique twisting motion – without ever pushing off the ground!

SPECIFICATIONS:

- **Deck:** High-tech polymer with removable deck plates
- **Platform:** Slip-resistant, concave, pivoting deck
- **Torsion Bar:** Rubber-padded steel
- **Wheels:** High-grade urethane on inclined, 360-degree casters

RIDER TYPE:

- **Age:** 8+
- **Max Rider Weight:** 220 lb (100 kg)

COLORS:

- SL | Item#: 15055002 | UPC: 8-17378-00898-5
- BL | Item#: 15055040 | UPC: 8-17378-00945-6
- PK | Item#: 15055061 | UPC: 8-17378-00942-5
- RD | Item#: 15055060 | UPC: 8-17378-00941-8



No assembly required



Always check local laws to see where and how particular Razor products may be ridden. An adult's decision to permit a child to use these products should be based upon Razor's recommendations and the child's skills, maturity and the ability to follow rules. Product specifications subject to change.

CLASSIC BRIGHTS

All the same features of the RipStik Classic, in vibrant contrasting colors. Stand out in the crowd with this fresh look.

SPECIFICATIONS:

- **Deck:** High-tech polymer with removable deck plates
- **Platform:** Slip-resistant, concave, pivoting deck
- **Torsion Bar:** Rubber-padded steel
- **Wheels:** High-grade urethane on inclined, 360-degree casters

RIDER TYPE:

- **Age:** 8+
- **Max Rider Weight:** 220 lb (100 kg)

COLORS:

-  TL/OR | Item#: 15055047 | UPC: 8-45423-01216-8
-  BL/PK | Item#: 15055062 | UPC: 8-45423-01240-3
-  RD/BL | Item#: 15055049 | UPC: 8-45423-01239-7

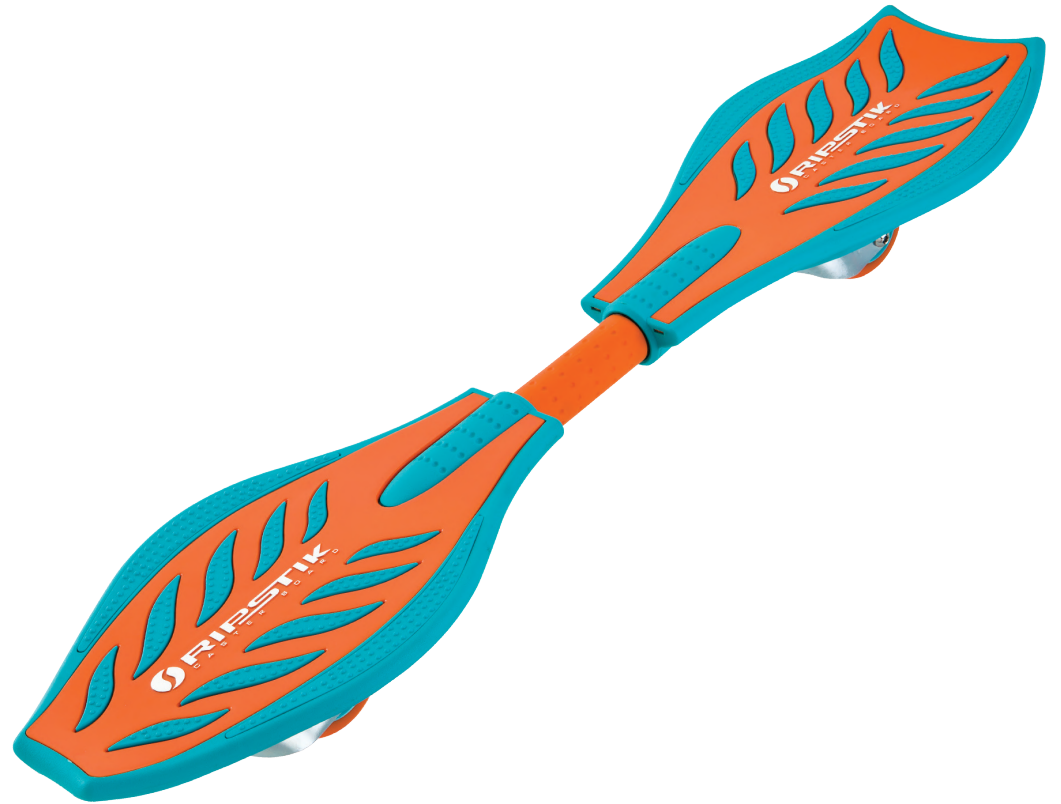

No assembly required



Always check local laws to see where and how particular Razor products may be ridden. An adult's decision to permit a child to use these products should be based upon Razor's recommendations and the child's skills, maturity and the ability to follow rules. Product specifications subject to change.

G

The “G” means this RipStik is an extreme grinding machine!
The aircraft-grade aluminum G-Tube spins to allow for super smooth grinds.

SPECIFICATIONS:

- **Deck:** High-tech polymer with removable deck plates
- **Platform:** Slip-resistant, concave, pivoting deck
- **Torsion Bar:** Spinning aircraft-grade aluminum G-tube
- **Wheels:** High-grade urethane on inclined, 360-degree casters

RIDER TYPE:

- **Age:** 8+
- **Max Rider Weight:** 220 lb (100 kg)

COLOR:

■ BK | Item#: 15055701 | UPC: 8-45423-00136-0



No assembly required



Always check local laws to see where and how particular Razor products may be ridden. An adult's decision to permit a child to use these products should be based upon Razor's recommendations and the child's skills, maturity and the ability to follow rules. Product specifications subject to change.

RIPSTER

Twist and go! The compact Razor RipStik Ripster has a short wheelbase for enhanced twist-and-carve action. It's perfect for riders with a small stance or those who want to take their tricks to the next level.

SPECIFICATIONS:

- **Deck:** High-tech polymer with removable deck plates
- **Platform:** Slip-resistant, concave deck
- **Torsion Bar:** Rubber-padded steel
- **Wheels:** High-grade urethane on inclined, 360-degree casters

RIDER TYPE:

- **Age:** 8+
- **Max Rider Weight:** 175 lb (79 kg)

COLORS:

 RD | Item#: 15055660 | UPC: 8-45423-00101-8

 BL | Item#: 15055640 | UPC: 8-45423-00102-5



No assembly required



Always check local laws to see where and how particular Razor products may be ridden. An adult's decision to permit a child to use these products should be based upon Razor's recommendations and the child's skills, maturity and the ability to follow rules. Product specifications subject to change.

RIPSURF

Surf Where You Live! The RipSurf - designed in Southern California. The RipSurf's patented design allows riders to carve and cut like a real surfboard, but on dry land! Riding on two high-performance caster wheels and an authentically-styled polypropylene deck, this is one ride-on that's ready to make waves!

SPECIFICATIONS:

- **Construction:** Lightweight, one-piece, fiber-reinforced, industrial-grade polymer
- **Deck:** Textured traction pad with kick tail
- **Wheels:** Inclined, 360-degree urethane casters
- **Patented RipStik® one-piece Torsion Technology**

RIDER TYPE:

- **Age:** 8+
- **Max Rider Weight:** 220 lb (100 kg)

COLORS:

■ BK | Item#: 15055016 | UPC: 8-45423-01618-0

■ CMYK | Item#: 15055990 | UPC: 8-45423-01631-9

■ BL | Item#: 15055940 | UPC: 8-45423-01742-2



No assembly required



Always check local laws to see where and how particular Razor products may be ridden. An adult's decision to permit a child to use these products should be based upon Razor's recommendations and the child's skills, maturity and the ability to follow rules. Product specifications subject to change.



Always check local laws to see where and how particular devices are allowed to be used. Use of these devices to permit a child to use these products should be based upon Ripstik's recommendations, the child's skills, maturity and the ability to follow rules. Product specifications subject to change.

SPARK REPLACEMENT PADS

SPARK REPLACEMENT CARTRIDGE

SCOOTER REPLACEMENT WHEELS

RIPSTIK REPLACEMENT WHEELS

RIPSTER REPLACEMENT WHEELS

RIDE-ON REPLACEMENT WHEELS





ACCESSORIES

Get the most out of your favorite Razor products with the ultimate Razor accessories. Whether it's performance, air or shredding you're after, they're designed for action and built to last.

SPARK REPLACEMENT PADS

Packaged Spark pad refills mean riders can keep on rolling and sparking!

SPECIFICATIONS:

- 4-pack
- **Compatibility:** Jetts, Jetts DLX

Item#: 35056101 | UPC: 8-45423-01659-3



SPARK REPLACEMENT CARTRIDGE

Packaged Spark cartridge refills mean riders can keep on sparking!

SPECIFICATIONS:

- 2-pack
- **Compatibility:** Spark Ultra and FlashRider 360

Item#: 35011091 | UPC: 8-45423-00558-0

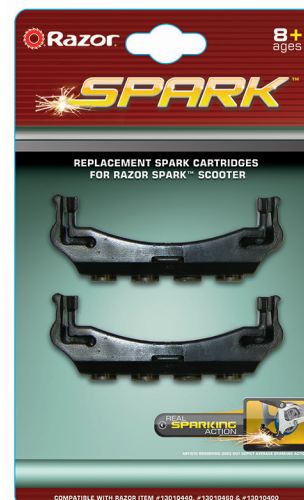

SCOOTER REPLACEMENT WHEELS

Compatible with A, A2, Spark Ultra and Sweet Pea.

SPECIFICATIONS:

- **Material:** High-grade urethane with bearings
- **2-pack**

COLORS:

-  BL | Item#: 134932-BL | UPC: 8-17378-00623-3
-  CL | Item#: 134932-CL | UPC: 8-17378-00621-9
-  GR | Item#: 134932-GR | UPC: 8-17378-00624-0
-  PK | Item#: 134932-PK | UPC: 8-17378-00640-0
-  PU | Item#: 134932-PU | UPC: 8-17378-00641-7
-  RD | Item#: 134932-RD | UPC: 8-17378-00622-6







RIPSTIK REPLACEMENT WHEELS

Replacement wheels compatible with Classic, G, RipSurf and Special Edition models.

SPECIFICATIONS:

- **Material:** High-grade urethane with bearings
- **2-pack**
- **Wheel Size:** 76 mm

COLORS:

-  BL | Item#: 35055040 | UPC: 8-45423-00003-5
-  GR | ITEM#: 35055030 | UPC: 8-45423-00005-9
-  PK | Item#: 35055061 | UPC: 8-45423-00004-2
-  RD | Item#: 35055060 | UPC: 8-45423-00002-8
-  SL | Item#: 35055000 | UPC: 8-45423-00001-1



RIPSTER REPLACEMENT WHEELS

Replacement wheels compatible with the Ripster models.

SPECIFICATIONS:

- **Material:** High-grade urethane with bearings
- **2-pack**
- **Wheel Size:** 68 mm

COLORS:

 BL | Item#: 35055640 | UPC: 8-45423-00112-4

 RD | Item#: 35055660 | UPC: 8-45423-00111-7



RIDE-ON REPLACEMENT WHEELS

Replacement caster wheels compatible with PowerWing, RipRider 360, FlashRider 360 and PowerRider 360.

SPECIFICATIONS:

- **Material:** High-grade urethane with bearings
- **2-pack**
- **Wheel Size:** 64 mm

COLORS:

 BL | Item#: 20036002058 | UPC: 8-45423-00332-6

 GR | Item#: 20036099058 | UPC: 8-45423-00334-0

 PK | Item#: 20036061058 | UPC: 8-45423-00333-3

 RD | Item#: 20036012058 | UPC: 8-45423-00120-9





WILD ONES

LIL' E

T3

FOLDING KIDDIE KICK

LIL' KICK





RAZOR JR.

Razor is not just for big kids! Preschoolers now have a line to call their very own. Razor Jr. boosts youngsters' balance and coordination while they have fun, on products sized just for them.

WILD ONES

Little ones go wild for the Wild Ones junior kick scooter, designed to help new riders build the balance they need to safely and confidently ride a two-wheeled scooter. Featuring a low to the ground deck perfect for learning, the Wild Ones junior kick scooter eliminates the need for a third wheel, enabling kids ages 30 months and up learn to balance on a two-wheeled ride. And with Shark, Dinosaur, and Unicorn inspired designs to choose from, there's a Wild One just right for every little one!

SPECIFICATIONS:

- **Frame:** Injection-molded plastic
- **Handlebars:** Steel-reinforced with 3D (lenticular) eye graphic
- **Grips:** Soft, foam
- **Deck:** Low to the ground, extra-wide, character-inspired graphics on full-deck grip tape
- **Wheels:** 6.5" (164 mm) diameter, 3" (76.2 mm) wide, slow-rolling tires
- **Patents Pending**

RIDER TYPE:

- **Age:** 30+ months
- **Max Rider Weight:** 44 lb (20 kg)

COLORS:

 UNICORN | Item#: 13059664 | UPC: 8-45423-02283-9

 SHARK | Item#: 13059643 | UPC: 8-45423-02286-0

 DINO | Item#: 13059630 | UPC: 8-45423-02289-1



Adult assembly required



Always check local laws to see where and how particular Razor products may be ridden. An adult's decision to permit a child to use these products should be based upon Razor's recommendations and the child's skills, maturity and the ability to follow rules. Product specifications subject to change.

LIL' E

Electric Fun For The Little Ones! It's a revolution in fun for the little ones – an electric scooter built specifically for youngsters still mastering their balance and coordination. The Lil' E provides the extra stability of three wheels and a simplified push-to-go, soft-start throttle that keeps them in control as they explore the thrills of electric-powered fun.

SPECIFICATIONS:

- **Speed:** Up to 2 mph (3 km/h)
- **Run Time:** Up to 60 minutes of continuous use
- **Drive Train:** Dual, rear wheel
- **Throttle:** "Go" button with "soft start" technology - slowly builds to full speed, stops when button is released
- **Frame:** Steel
- **Deck:** Large platform for stability
- **Battery:** 6V sealed lead-acid, rechargeable
- **Includes:** Battery charger

RIDER TYPE:

- **Age:** 3+
- **Max Rider Weight:** 44 lb (20 kg)

COLORS:

 GR | Item#: 20159640 | UPC: 8-45423-01616-6

 PK | Item#: 20159661 | UPC: 8-45423-01615-9



Adult assembly required



Always check local laws to see where and how particular Razor products may be ridden. An adult's decision to permit a child to use these products should be based upon Razor's recommendations and the child's skills, maturity and the ability to follow rules. Product specifications subject to change.

T3

The Only Three-wheeler You'll Ever Need! Spark a love for riding that lasts a lifetime with the Razor Jr. t3. Easy to turn and hard to tip over, the t3 is the perfect introduction to the world of Razor scooters, with a patent-pending, three-wheel design that helps young riders build core balance and riding skills. It's a first ride they'll never forget and hate to give up.

SPECIFICATIONS:

- **Steering:** Advanced tilt-to-turn technology
 - Smoother steering
 - Improved turning angle
 - More responsive action
- **Higher performance extends the maximum rider age of the scooter**
- **Handlebars:** Steel
- **Grips:** Soft, rubber
- **Wheels:** 120 mm, urethane front with sealed bearings, 76 mm rear
- **Deck:** Flexible, slip-resistant polypropylene
- **Brake:** Rear-fender
- **Includes:** Tilt-to-turn action viewable through bubble
- **Construction:** Lightweight and durable
- **Assembly:** 1-step, tool-free
- **Patent Pending**

RIDER TYPE:

- **Age:** 3+
- **Max Rider Weight:** 48 lb (22 kg)

COLORS:

GR | Item#: 20059631 | UPC: 8-45423-01613-5

PK | Item#: 20059666 | UPC: 8-45423-01612-8



Adult assembly required



Always check local laws to see where and how particular Razor products may be ridden. An adult's decision to permit a child to use these products should be based upon Razor's recommendations and the child's skills, maturity and the ability to follow rules. Product specifications subject to change.

FOLDING KIDDIE KICK

Now little ones have a scooter they can call their own! With the Folding Kiddie Kick, riding a scooter is fun and easy for children under 44 pounds (20 kg). It folds and features a stable, three-wheel design, extra-wide, slip-resistant deck.

SPECIFICATIONS:

- **Frame:** Steel
- **Handlebars:** Steel
- **Grips:** Foam
- **Downtube:** Folding
- **Deck:** Extra-wide, slip-resistant polypropylene
- **Wheels:** Polymer

RIDER TYPE:

- **Age:** 3+
- **Max Rider Weight:** 44 lb (20 kg)

COLORS:

BL | Item#: 13015040 | UPC: 8-17378-00928-9

PK | Item#: 13015061 | UPC: 8-45423-00073-8



Adult assembly required



Always check local laws to see where and how particular Razor products may be ridden. An adult's decision to permit a child to use these products should be based upon Razor's recommendations and the child's skills, maturity and the ability to follow rules. Product specifications subject to change.

LIL' KICK

The Lil' Kick's stand-alone, three-wheel design makes for a more stable ride that helps young riders build coordination. The extra-wide, slip-resistant deck keeps tots on their little toes.

SPECIFICATIONS:

- **Frame:** Steel
- **Handlebars:** Padded, steel
- **Deck:** Extra-wide, slip-resistant polypropylene
- **Grips:** Polymer
- **Wheels:** Extra-large, polymer

RIDER TYPE:

- **Age:** 3+
- **Max Rider Weight:** 44 lb (20 kg)

COLORS:

 BL | Item#: 13014939 | UPC: 8-45423-02071-2

 PK | Item#: 13014963 | UPC: 8-45423-02072-9



Adult assembly required



Always check local laws to see where and how particular Razor products may be ridden. An adult's decision to permit a child to use these products should be based upon Razor's recommendations and the child's skills, maturity and the ability to follow rules. Product specifications subject to change.

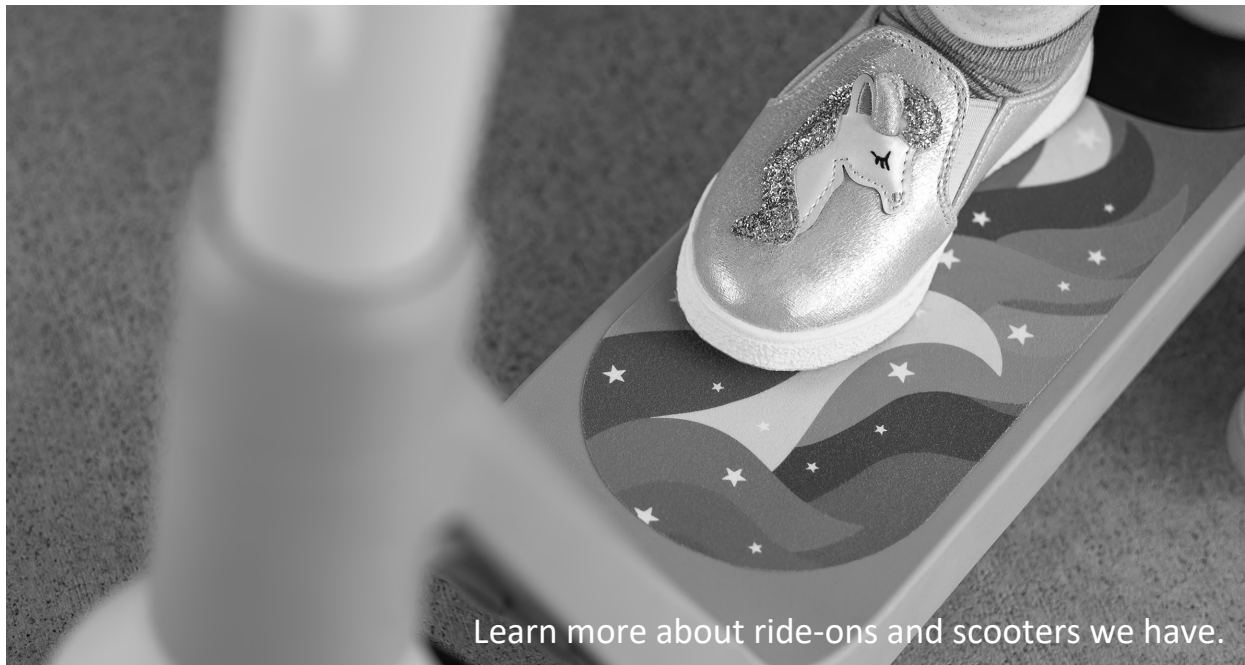

Learn more about ride-ons and scooters we have.