

2022

FULL PRODUCT CATALOG

- OPTICS
- MOUNTS
- ACCESSORIES
- TOOLS
- OUTDOOR GEAR
- PROTECTIVE GEAR



VISM
A DIVISION OF NcSTAR

SIGHTS ON INNOVATION®

VISM
STRIKE FACE

OVER 25 YEARS IN THE INDUSTRY



Founded in Southern California in 1997, NcSTAR®'s mission is to consistently provide superior quality optics and sporting accessories at affordable prices. We are dedicated to providing superb customer service, setting the highest standard in the industry, with a warranty that is second to none. We provide innovative and cutting edge optics and accessories by following the latest industry trends and listening to our customer's feedback.



Started in 2010 VISM®, a division of NcSTAR®, was launched out of the desire to create a new brand of products with higher end features and innovation that our customers desire along with the same great warranty and high standard of customer service.

C O N T E N T S

OPTICS & ACCESSORIES

NEW PRODUCTS	SCOPES	MOUNTING SYSTEM	ACCESSORIES	BIPODS
04 NEW VG Series	33 STR Series	43 AR Mounts	63 Rail Covers and Hand Stops	86 KPM Bipods
09 NEW PRODUCTS	35 MARK III Tactical Series	47 AK Mounts	64 Grips	87 Precision Grade Bipods
TOOLS	37 ADO Series	50 Shotgun Mounts	66 Iron Sights	87 Standard Bipods
14 Handgun Tools	38 ECO Series	53 Ruger Mounts	68 Sling/Bipod Adapters	
17 AR Tools	39 CPO Series	54 SKS Mounts	69 Muzzle Brakes	
20 Gunsmith Tool Kit	40 Compact Tactical Series	55 Handgun Mounts	70 AR Accessories	
21 Mag Loader & Stripper Clips	40 Long Eye Relief Series	56 Rail Adapters	71 Carry Handles	
22 M&P15-22 Tools & Accessories	41 SRT Series	57 Specialized Mounts		
22 AK & SKS Tools & Accessory	41 Delta Series	58 Riser Mounts		
23 Cleaning Tools	42 DUO Series	RING MOUNTS	FLASHLIGHTS & LASERS	
23 Lasers Bore Sighters	42 XRS Series	59 1in	72 Long Gun Flashlights	
REFLEX OPTICS	42 LIO Series	61 30mm/1in	73 Flashlights	
24 Heads Up			74 Handgun Flashlights	
26 Small Tube			75 Blue Lasers	
28 Dual Targeting			76 Green Lasers	
30 Micro Dot			78 Red Lasers	
32 Large Tube			81 Flashlight & Laser Combos	
32 Magnifier			84 Lasers Designators	

PERFORMANCE GEAR

89 Ballistic Plates & Panels	114 Concealed Carry Purses	136 Magazine Pouches
91 NIJ Plates	117 Concealed Carry	141 Holsters & Accessories
92 Ballistic Shields	119 Deluxe Cases	145 Slings
93 Plate Carrier Ballistic Combos	122 Shooting Mats	147 Shooter's Gear Accessories
97 Backpack Ballistic Combos	123 Rifle Cases	151 First Responder's Gear
99 GuardianPack™	125 Shotgun Cases	153 ORYX Tactical Boots
100 Ballistic Helmets	127 Subgun, AR, & AK Pistol Cases	154 Outdoor Apparel
101 Vest & Chest Rigs	128 Scabbards	156 Outdoor Gear
108 K9 Vest	131 Range Bags & Pistol Cases	157 Holiday
109 Backpacks		

NEW VG SERIES

COLLAPSIBLE BUTTSTOCKS

TBS TACTICAL STOCK MIL-SPEC

MODEL: VG087 - BLACK
MODEL: VG087T - TAN



- Collapsible buttstock for **MIL-SPEC** buffer tubes.
- Sleek design with metal QD base on each side for QD slings and several molded in 1.5" sling loops.
- Integrated rubber butt pad for non-slip secure shouldering, comfort, and recoil mitigation.
- Unique latch mechanism, first click for adjusting stock position and a second full click for mounting/demounting from the buffer tube.
- Dimensions: 7.75"L X 5.25"W X 2.0"D
- Weight: 9.7 oz.
- Patented
- Made in Turkey

TBS TACTICAL STOCK WITH COMPACT CHEEK RISER MIL-SPEC

MODEL: VG087042 - BLACK
MODEL: VG087042T - TAN



- Collapsible buttstock for **MIL-SPEC** buffer tubes.
- Sleek design with metal QD base on each side for QD slings and several molded in 1.5" sling loops.
- Integrated rubber butt pad for non-slip secure shouldering, comfort, and recoil mitigation.
- Six position height adjustable cheek riser, up to 1.2" height.
- **Compact riser 3.8"L**
- Unique latch mechanism, first click for adjusting stock position and a second full click for mounting/demounting from the buffer tube.
- Dimensions: 7.75"L X 5.25"W X 2.0"D
- Weight: 14.4 oz.
- Patented
- Made in Turkey

TBS TACTICAL STOCK WITH STANDARD CHEEK RISER MIL-SPEC

MODEL: VG087052 - BLACK
MODEL: VG087052T - TAN



- Collapsible buttstock for **MIL-SPEC** buffer tubes.
- Sleek design with metal QD base on each side for QD slings and several molded in 1.5" sling loops.
- Integrated rubber butt pad for non-slip secure shouldering, comfort, and recoil mitigation.
- Six position height adjustable cheek riser, up to 1.2" height.
- **Standard riser 5.6"L**
- Unique latch mechanism, first click for adjusting stock position and a second full click for mounting/demounting from the buffer tube.
- Dimensions: 7.75"L X 5.25"W X 2.0"D
- Weight: 14.6 oz.
- Patented
- Made in Turkey

TBS COMPACT STOCK MIL-SPEC

MODEL: VG130 - BLACK
MODEL: VG130T - TAN



- Collapsible buttstock for **MIL-SPEC** buffer tubes.
- Compact stock - 0.75" shorter overall length
- Sleek design with metal QD base on each side for QD slings and several molded in 1.5" sling loops.
- Integrated rubber butt pad for non-slip secure shouldering, comfort, and recoil mitigation.
- Unique latch mechanism, first click for adjusting stock position and a second full click for mounting/demounting from the buffer tube.
- Dimensions: 7.0"L X 5.25"W X 2.0"D
- Weight: 8.8 oz.
- Patented
- Made in Turkey

TBS COMPACT STOCK WITH STANDARD CHEEK RISER MIL-SPEC

MODEL: VG130052 - BLACK
MODEL: VG130052T - TAN



- Collapsible buttstock for **MIL-SPEC** buffer tubes. Compact stock - 0.75" shorter overall length
- Sleek design with metal QD base on each side for QD slings and several molded in 1.5" sling loops.
- Integrated rubber butt pad for non-slip secure shouldering, comfort, and recoil mitigation.
- Six position height adjustable cheek riser, up to 1.2" height.
- **Standard riser 5.6"L**
- Unique latch mechanism, first click for adjusting stock position and a second full click for mounting/demounting from the buffer tube.
- Dimensions: 7.0"L X 5.25"W X 2.0"D
- Weight: 13.8 oz.
- Patented
- Made in Turkey

COLLAPSIBLE BUTTSTOCKS

TBS SHARP STOCK MIL-SPEC

MODEL: VG129 - BLACK
MODEL: VG129T - TAN



TBS SHARP STOCK * COMMERCIAL SPEC *

MODEL: VG131 - BLACK
MODEL: VG131T - TAN



TBS CLASSIC STOCK WITH * COMMERCIAL SPEC *

MODEL: VG086 - BLACK
MODEL: VG086T - TAN



- Collapsible buttstock for **MIL-SPEC** buffer tubes.
- Sleek design with metal QD base on each side for QD slings and several molded in 1.5" sling loops.
- Integrated rubber butt pad for non-slip secure shouldering, comfort, and recoil mitigation.
- Unique latch mechanism, first click for adjusting stock position and a second full click for mounting/dismounting from the buffer tube.
- Dimensions: 7.75"L X 5.25"W X 2.0"D
- Weight: 9.7 oz.
- Patented
- Made in Turkey

- Collapsible buttstock for **COMMERCIAL SPEC** buffer tubes.
- Sleek design with metal QD base on each side for QD slings and several molded in 1.5" sling loops.
- Integrated rubber butt pad for non-slip secure shouldering, comfort, and recoil mitigation.
- Unique latch mechanism, first click for adjusting stock position and a second full click for mounting/dismounting from the buffer tube.
- Dimensions: 7.75"L X 5.25"W X 2.0"D
- Weight: 9.7 oz.
- Patented
- Made in Turkey

- Collapsible buttstock for **COMMERCIAL SPEC** buffer tubes.
- Sleek design with metal QD base on each side for QD slings.
- Integrated rubber butt pad for non-slip secure shouldering, comfort, and recoil mitigation.
- Unique latch mechanism, first click for adjusting stock position and a second full click for mounting/dismounting from the buffer tube.
- Dimensions: 8.0"L X 4.75"W X 1.5"D
- Weight: 7.9 oz.
- Patented
- Made in Turkey

SHOTGUN STOCK ADAPTERS

SHOTGUN GRIP ADAPTOR END CAP PLUG

MODEL: VG080 - BLACK
MODEL: VG080T - TAN



- Fills in the rear opening of the shotgun grip adaptors.
- Integrated sling loop for attaching slings.
- Made of quality reinforced polymer composite.
- Made in Turkey

SHOTGUN LEFT SIDE HINGED FOLDING STOCK ADAPTER

MODEL: VG076 - BLACK
MODEL: VG076T - TAN



- Left side folding stock adapter.
- Compatible with VG108 & VG118 Shotgun Grip adapters
- Works with telescoping stock tube VG094
- Made of quality reinforced polymer composite.
- Made in Turkey

SHOTGUN RIGHT SIDE HINGED FOLDING STOCK ADAPTER

MODEL: VG127 - BLACK
MODEL: VG127T - TAN



- Right side folding stock adapter.
- Compatible with VG108 & VG118 Shotgun Grip adapters
- Works with telescoping stock tube VG094
- Made of quality reinforced polymer composite.
- Made in Turkey

SHOTGUN TELESCOPING COMMERCIAL SPEC STOCK TUBE

MODEL: VG094 - BLACK
MODEL: VG094T - TAN



- Compatible with VG108 & VG118 Shotgun Grip adapters
- Commercial Spec stock tube adapter works with a variety of AR style Commercial Spec collapsible stocks like the VG131 and VG086 stocks
- 5 separate positions for AR style collapsible stocks, for optimal length-of-pull adjustment
- Constructed from durable fiberglass reinforced polymer composite and a steel insert
- Made in Turkey

NEW VG SERIES

SHOTGUN STOCK ADAPTERS & HANDGUARDS

**REMINGTON 870
GRIP AND STOCK ADAPTER**
MODEL: VG108 - BLACK
MODEL: VG108T - TAN



- Remington 870 ergonomic pistol grip adapter with finger grooves and textured non-slip grip. Modular grip adapter design that is easy to configure with many options.
- Grip adapter works with the optional: grip end cap, AR style fixed, and left/right folding stock adapters. (VG080, VG094, VG076, VG127)
- Allows you to use AR style collapsible buttstocks with the optional AR style stock adaptor attachments.
- QD sling attachments on both sides of the grip adapter.
- Storage compartment with tight-sealing door for batteries and cleaning kits.
- Made of quality reinforced polymer composite.
- All mounting hardware included.
- Dimensions: 6.25"L X 4.0"W X 1.5"D
- Weight: 7.8 oz.
- Made in Turkey

**REMINGTON 870
M-LOK® HANDGUARD**
MODEL: VG135 - BLACK
MODEL: VG135T - TAN



- Remington 870 M-LOK® shotgun handguard has M-LOK® slots on both sides and bottom for mounting accessories.
- Handguard is 7.25" (184mm) long.
- Quick & easy installation replaces the original factory handguard.
- Durable and lightweight construction and sleek design.
- Constructed from reinforced, heat-resistant fiberglass reinforced polymer composite
- Dimensions: 7.25"L X 2.1"W X 1.9"D
- Weight: 5.0 oz.
- Made in Turkey

**MOSSBERG 500 / 590
GRIP AND STOCK ADAPTER**
MODEL: VG118 - BLACK
MODEL: VG118T - TAN



- Works with Mossberg 500/590 and Maverick 88 shotguns. Ergonomic pistol grip adapter with finger grooves and textured non-slip grip. Modular grip adapter design that is easy to configure with many options.
- Grip adapter works with the optional: grip end cap, AR style fixed, and left/right folding stock adapters. (VG080, VG094, VG076, VG127)
- Allows you to use AR style collapsible buttstocks with the optional AR style stock adaptor attachments.
- QD sling attachments on both sides of the grip adapter.
- Storage compartment with tight-sealing door for batteries and cleaning kits.
- Made of quality reinforced polymer composite.
- All mounting hardware included.
- Dimensions: 6.25"L X 4.0"W X 1.5"D
- Weight: 7.2 oz.
- Made in Turkey

**MOSSBERG 500 / 590
M-LOK® HANDGUARD**
MODEL: VG145 - BLACK
MODEL: VG145T - TAN



- Mossberg 500/590 and Maverick 88 M-LOK® shotgun handguard has M-LOK® slots on both sides and bottom for mounting accessories.
- Handguard is 8.0" (203mm) long.
- Quick & easy installation replaces the original factory handguard.
- Durable and lightweight construction and sleek design.
- Constructed from reinforced, heat-resistant fiberglass reinforced polymer composite
- Dimensions: 8.1"L X 2.25"W X 1.9"D
- Weight: 5.6 oz.
- Made in Turkey

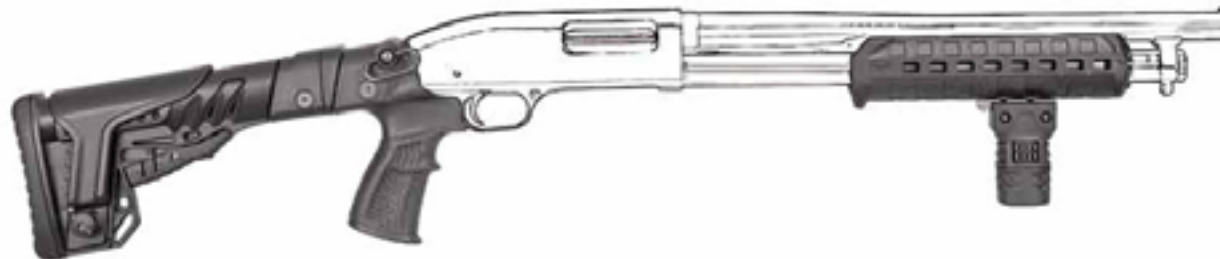

AR15 PISTOL GRIPS & 1913 PICATINNY ACCESSORIES

AR15 POLYMER GRIP

MODEL: VG060 - BLACK
MODEL: VG060T - TAN



- Polymer grip for AR platforms with non-slip texturing
- Improves trigger operation, reduces wrist fatigue, and develops better rifle control
- Storage compartment with tight-sealing door for batteries and cleaning kits
- All mounting hardware included
- Made in Turkey

AR15 ERGONOMIC GRIP

MODEL: VG090 - BLACK
MODEL: VG090T - TAN



- Ergonomic grip for AR platforms with finger grooves for enhanced and more comfortable grip
- Improves trigger operation, reduces wrist fatigue, and develops better rifle control
- Storage compartment with tight-sealing door for batteries and cleaning kits
- All mounting hardware included
- Made in Turkey

AR15 RUBBERIZED GRIP WITH BEAVERTAIL

MODEL: VG138 - BLACK
MODEL: VG138T - TAN



- Rubberized grip for AR platforms with beavertail for more comfortable grip
- Improves trigger operation, reduces wrist fatigue, and develops better rifle control
- Storage compartment with tight-sealing door for batteries and cleaning kits
- All mounting hardware included
- Made in Turkey

PICATINNY VERTICAL GRIP MID-LENGTH

MODEL: VG116- BLACK
MODEL: VG116T - TAN



- 1913 MIL-STD Picatinny textured Mid-Length vertical grip
- Includes two side clamp mounts: one plain and one with a side 1913 rail.
- Storage compartment for batteries and cleaning kits.
- Made of quality reinforced polymer composite.
- All mounting hardware included.
- Height: 3.75"H, Weight: 3.8 oz.
- Made in Turkey

PICATINNY VERTICAL GRIP SHORT LENGTH

MODEL: VG117- BLACK
MODEL: VG117T - TAN



- 1913 MIL-STD Picatinny textured Short Length vertical grip
- Includes two side clamp mounts: one plain and one with a side 1913 rail.
- Storage compartment for batteries and cleaning kits.
- Made of quality reinforced polymer composite.
- All mounting hardware included.
- Height: 2.75"H, Weight: 3.25 oz.
- Made in Turkey

PICATINNY HAND STOP WITH QD MOUNT

MODEL: VG159 - BLACK
MODEL: VG159T - TAN



- Ergonomically shaped and textured Tactical Hand Stop with QD sling mount.
- Mounts onto 1913 MIL-STD Picatinny rails.
- Hand stop can be mounted in either direction.
- Made of quality reinforced polymer composite.
- All mounting hardware included.
- Length: 5.0", Weight: 1.7 oz.
- Made in Turkey

PICATINNY LADDER RAIL COVERS 30 SLOTS

MODEL: VG077B - BLACK
MODEL: VG077T - TAN
MODEL: VG077G - GREEN



- Ladder Picatinny rail cover protects unmounted rail areas from damage and shield the operator from sharp rail edges.
- Quick & easy installation, snaps into place over exposed sections of rail for improved grips and comfort.
- Covers up to 30 rail slots and is easy to cut for custom lengths.
- Rubbery, slip resistant, durable, heat resistant, and light weight construction
- Length: 12.5"
- Made in Turkey

NEW VG SERIES

AK POLYMER GRIP MODEL: VG097 - BLACK MODEL: VG097T - TAN



- Polymer grip for AK platforms with non-slip texturing
- Improves trigger operation, reduces wrist fatigue, and develops better rifle control
- Storage compartment with tight-sealing door for batteries and cleaning kits
- All mounting hardware included
- Made in Turkey

AK ERGONOMIC GRIP MODEL: VG107 - BLACK MODEL: VG107T - TAN



- Ergonomic grip for AK platforms with finger grooves for enhanced and more comfortable grip
- Improves trigger operation, reduces wrist fatigue, and develops better rifle control
- Storage compartment with tight-sealing door for batteries and cleaning kits
- All mounting hardware included
- Made in Turkey

AK ACCESSORIES

AK M-LOK® HANDGUARDS W/TOP & BOTTOM 1913 RAILS MODEL: VG099 - BLACK MODEL: VG099T - TAN



- Features 1913 MIL-STD Picatinny rails on the top and bottom halves of the handguard.
- M-LOK® slots on both sides of lower and upper AK handguard
- Constructed from reinforced, heat-resistant fiberglass reinforced polymer composite

▪ Made in Turkey

AK M-LOK® HANDGUARDS WITH TOP 1913 RAILS MODEL: VG133 - BLACK MODEL: VG133T - TAN



- Features 1913 MIL-STD Picatinny rails on the top of the handguard
- M-LOK® slots on both sides of lower and upper AK handguard
- Constructed from reinforced, heat-resistant fiberglass reinforced polymer composite

▪ Made in Turkey

AK M-LOK® HANDGUARDS WITH TOP 1913 RAILS MODEL: VG136 - BLACK MODEL: VG136T - TAN



- Features 1913 MIL-STD Picatinny rails on the top of the handguard
- M-LOK® slots on both sides of lower and upper AK handguard
- Constructed from reinforced, heat-resistant fiberglass reinforced polymer composite
- Premium Polymer with more heat shielding properties.

▪ Made in Turkey

AK TELESCOPING FIXED STOCK TUBE MIL-SPEC MODEL: VG146 - BLACK MODEL: VG146T - TAN

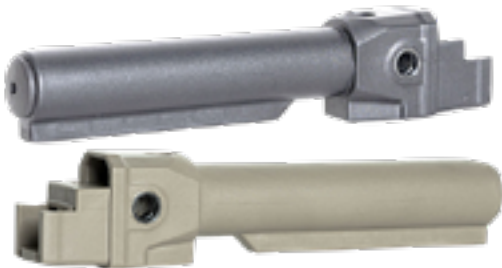

- Mil-Spec stock tube mount non-folding adapter for AK variants.
- Mounts onto AKM pattern stamped receivers with square cut flat rear receiver section.
- Allows a variety of AR style Mil-Spec collapsible buttstocks to be installed onto an AK variant.
- QD sling mounts on both sides of the stock adapter.
- Stock tube is hollow with a rubber end plug and it can be used to store parts and cleaning tools.
- Easy and simple to install.
- All mounting hardware included
- Made in Turkey

AK TELESCOPING FOLDABLE STOCK TUBE MIL-SPEC MODEL: VG147 - BLACK MODEL: VG147T - TAN



- Mil-Spec stock tube mount side foldable adapter for AK variants.
- Mounts onto AKM pattern stamped receivers with square cut flat rear receiver section.
- Allows a variety of AR style Mil-Spec collapsible buttstocks to be installed onto an AK variant.
- QD sling mounts on both sides of the stock adapter.
- Stock tube is hollow with a rubber end plug and it can be used to store parts and cleaning tools.
- Easy and simple to install.
- All mounting hardware included
- Made in Turkey

NEW DESIGNED IN USA

AR15 LOWER RECEIVER VICE BLOCK

MODEL# VTARLWRVB
US PATENT PENDING



- AR15 Lower Receiver Vice Block allows you to mount a MIL-Spec AR15 receiver to the vise block, for securing the AR lower receiver to a bench vise for maintenance and assembly.
- Includes a removable buffer tube mount ring to aid in installing carbine buffer tube straight and plumb onto the receiver. It will hold and lock the carbine buffer tube in place, so that the castle nut can be properly tightened without misaligning the buffer tube.
- INCLUDES: AR15 lower receiver vise block, Buffer tube support ring with three thumb screws, Pistol grip bolt for securing receiver to the vise block
- MATERIAL: Anodized Blue aluminum
- DIMENSIONS: 7.5"L X 2.4"W X 4.8"H
- WEIGHT: 28.5 OZ.

NEW DESIGNED IN USA

AR15 FRONT RECEIVER PIN TOOL

MODEL# VTARFRP

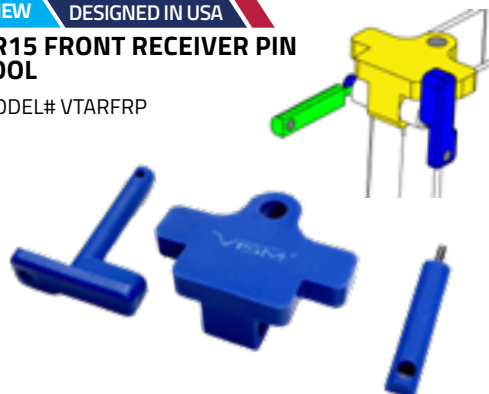

- AR15 Front Receiver Pin Tools help with the installation of the front AR receiver pin assembly onto an AR lower receiver.
- The three separate polymer tools work together to help make the process of installing the front receiver pin assembly an easy job.
- INCLUDES: Front Receiver Pin - Guide Plate Jig Tool (Yellow), Front Receiver Pin - Receiver Pin Spring & Detent Tool (Blue), Front Receiver Pin - Detent Push Pin Tool (Green)
- MATERIAL: Blue Polymer, steel (Detent push pin tool)
- DIMENSIONS: 7.5"L X 2.4"W X 4.8"H
- WEIGHT: 28.5 OZ.

NEW DESIGNED IN USA

AR15 BOLT CATCH LEVER TOOL

MODEL# VTARBLCATCH

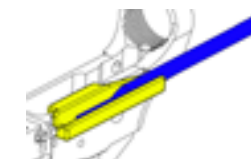

- AR15 Front Receiver Pin Tools help with the installation of the front AR receiver pin assembly onto an AR lower receiver.
- The three separate polymer tools work together to help make the process of installing the front receiver pin assembly an easy job.
- INCLUDES: Front Receiver Pin - Guide Plate Jig Tool (Yellow), Front Receiver Pin - Receiver Pin Spring & Detent Tool (Blue), Front Receiver Pin - Detent Push Pin Tool (Green)
- MATERIAL: Blue Polymer, steel (Detent push pin tool)
- DIMENSIONS: 7.5"L X 2.4"W X 4.8"H
- WEIGHT: 28.5 OZ.

NEW DESIGNED IN USA

AR15 PRO CROWS FOOT BUFFER TUBES TOOL

MODEL# VTARCFWRP



- Crows Foot PRO tool for AR15 Buffer Tubes
- AR15/ M4 Castle Nut spanner wrenches for telescoping stock tubes
- AR15 Rifle A2 buffer tube wrench
- Flat blade screwdriver for securing A2 buttstock plate screws
- 1/2" and 3/8" drive compatible
- Steel construction
- DIMENSIONS: 3.4"L X 3.9"W X 0.4"D
- WEIGHT: 8.6 oz.

NEW DESIGNED IN USA

AR15 CROWS FOOT CASTLE NUT TOOL

MODEL# VTARCFWR



- Crows Foot for AR15/ M4 GI Spec Castle Nuts for telescoping stock tubes
- 1/2" and 3/8" drive compatible
- Steel construction
- DIMENSIONS: 3.4"L X 2.0"W X 0.4"D
- WEIGHT: 6.7 oz.

NEW DESIGNED IN USA

AR15 CROWS FOOT GI BARREL NUT TOOL

MODEL# VTARCBRL



- AR15 Barrel Nut Crows Foot for GI spec barrel nuts
- 1/2" and 3/8" drive compatible for torquing your barrel nut to the proper torque specifications
- Steel construction
- DIMENSIONS: 3.5"L X 2.2"W X 0.7"D
- WEIGHT: 8.0 oz.

NEW PISTOL TOOLS

NEW PRODUCTS

NEW DESIGNED IN USA

SLIDE VICE BLOCK TOOL FOR GLOCK® SLIDES

MODEL# VTVBGLK

US PATENT PENDING



- Most of the Glock® slides will mount onto the vice block for securing the slide onto a vice. The slide vice block makes it easier to work on and service the slide.
- A great way to secure the slide onto the vice jaws to replace and replace the rear sight on the slide.
- Insert the slide vice block onto the frame rail grooves of the slide and mount onto the jaws of a vice. Gradually tighten the vice jaws onto the slide vice block, until the slide is secured. Do not overtighten vice jaws.
- FITS MOST SLIDES: Designed to fit most of the Standard, Compact, Subcompact framed models: 9mm, .40, .45, 10mm, .357 SIG, .45 GAP
- This slide vice block will not fit compact/subcompact slimline models: 42, 43, 43X, 48
- MATERIAL: Anodized Blue aluminum
- DIMENSIONS: 3.0"L X 1.4"W X 1.4"H
- WEIGHT: 5.9 OZ.
- **DISCLAIMER:** "GLOCK" is a federally registered trademark of GLOCK, Inc. and is one of many trademarks owned by GLOCK, Inc. and GLOCK Ges.m.b.H. Neither NcSTAR Inc. nor this site are affiliated in any manner with, or otherwise endorsed by, GLOCK, Inc. or GLOCK Ges.m.b.H. The use of "GLOCK" on this page is merely to advertise the sale of GLOCK pistols, parts, or components.

NEW DESIGNED IN USA

SLIDE VICE BLOCK TOOL FOR XD® SLIDES

MODEL# VTVBXD

US PATENT PENDING

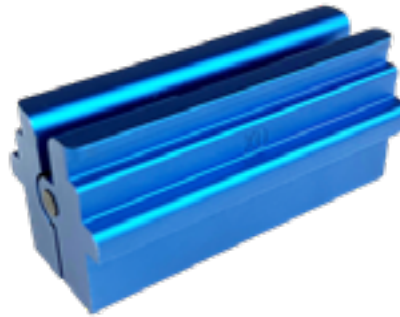

- The Springfield XD® series 9mm & .40 slides mount onto the vice block for securing the slide onto a vice.
- The slide vice block makes it easier to work on and service the slide.
- A great way to secure the slide onto the vice jaws to remove and replace the front and rear sights on the slide.
- Insert the slide vice block onto the frame rail grooves of the slide and mount onto the jaws of a vice. Gradually tighten the vice jaws onto the slide vice block, until the slide is secured. Do not overtighten vice jaws.
- FITS MOST SLIDES: Designed to fit most of the XD9 and XD40 slides
- MATERIAL: Anodized Blue aluminum
- DIMENSIONS: 3.0"L X 1.4"W X 1.4"H
- WEIGHT: 6.0 OZ.

NEW DESIGNED IN USA

SLIDE VICE BLOCK TOOL FOR 1911 S

MODEL# VTVB1911

US PATENT PENDING

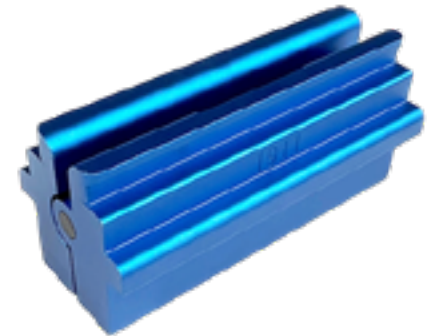

- Standard 1911 slide mounts onto the vice block for securing the slide onto a vice.
- The slide vice block makes it easier to work on and service the slide.
- A great way to secure the slide onto the vice jaws to remove and replace the dovetail front and rear sights on the slide.
- Insert the slide vice block onto the frame rail grooves of the slide and mount onto the jaws of a vice. Gradually tighten the vice jaws onto the slide vice block, until the slide is secured. Do not overtighten vice jaws.
- FITS MOST SLIDES: Designed to fit most of the 1911 slides
- MATERIAL: Anodized Blue aluminum
- DIMENSIONS: 3.0"L X 1.4"W X 1.4"H
- WEIGHT: 5.8 OZ.

NEW PICATINNY RAIL RISERS & M-LOK ADAPTERS

NEW PRODUCTS

NEW DESIGNED IN USA

0.41" H PICATINNY RAIL RISERS

MODELS #

- M1913RIS410L - LONG
- M1913RIS410S - SHORT

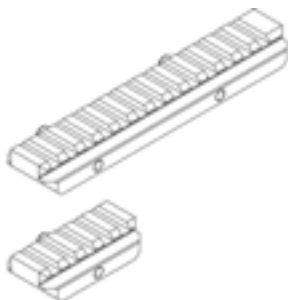

- 1913 Picatinny Rail 0.41" H risers
- Allows the user to raise their optic 0.41" above their receiver height Picatinny rail for the desired optic height
- MATERIAL: Black Anodized Aluminum

SPECIFICATIONS	M1913RIS410L	M1913RIS410S
HEIGHT	0.41"	0.41"
LENGTH	5.5"	2.2"
WEIGHT	3.6 oz.	1.4 oz.

NEW DESIGNED IN USA

0.625" H PICATINNY RAIL RISERS

MODELS #

- M1913RIS625C - CANTILEVER
- M1913RIS625L - LONG
- M1913RIS625S - SHORT

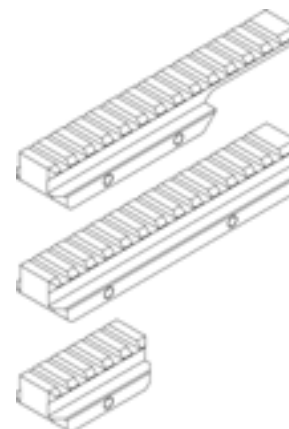

- 1913 Picatinny Rail 0.625" H risers
- Allows the user to raise their optic 0.625" above their receiver height Picatinny rail for the desired optic height
- Also desirable for a better heads-up shooting with night vision equipment
- MATERIAL: Black Anodized Aluminum

SPECIFICATIONS	M1913RIS625C	M1913RIS625L	M1913RIS625S
HEIGHT	0.625"	0.625"	0.625"
LENGTH	5.5"	5.5"	2.2"
WEIGHT	3.7 oz.	4.7 oz.	1.9 oz.

NEW DESIGNED IN USA

PICATINNY RAIL ADAPTER TO M-LOK®

MODELS #

- MPAML - LONG 3 FULL SLOTS
- MPAMD3S - MEDIUM 2 HALF SLOTS AND 1 FULL SLOT
- MPAMD2S - MEDIUM 2 FULL SLOTS
- MPAMS - SHORT 1 FULL SLOT

- 1913 Picatinny Rail to M-LOK® Adapter
- Allows the user to mount M-LOK® accessories to 1913 Picatinny rails
- MATERIAL: Black Anodized Aluminum

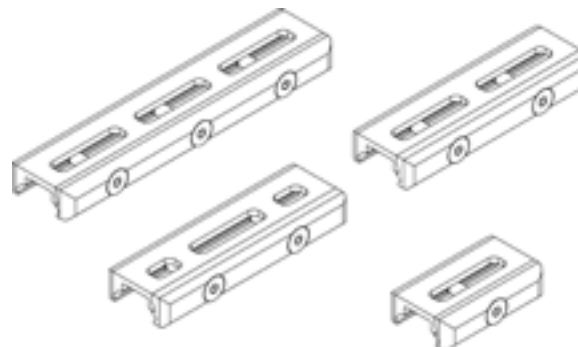

SPECIFICATIONS	MPAML	MPAMD3S	MPAMD2S	MPAMS
LENGTH	5.0"	3.5"	3.5"	1.9"
WEIGHT	2.3 oz.	1.6 oz.	1.6 oz.	0.8 oz.

NEW TARGET STAND

NEW DESIGNED IN USA

STEEL TARGET STAND

MODELS # VATS



- The heavy-duty steel target stand's larger center steel box section will accommodate a 2" X 4" wood post for heavier steel targets
- The two side steel box sections will accommodate a pair of 1" X 2" furring strip boards for paper and cardboard targets
- Includes three plastic knobbed metal bolts for securing lumber to the target stand
- Two steel 2"X2" angle iron side legs are 24" long, they provide target stand stability for those heavy steel targets (not included)
- No tools required for assembly
- Legs bolt onto the center section with carriage bolts and with wing nuts
- Steel Target stand breaks down to a compact space
- MATERIAL: Steel Painted Blue
- DIMENSIONS: 24.0"L X 23.0" W X 6.0"H (Assembled)
- DIMENSIONS: 24.0"L X 3.0"W X 6.0"H (Unassembled)
- WEIGHT 12.0 lbs.

NEW DESIGNED IN USA

SWITCH COVER®

MODEL #	DIAMETER	WEIGHT
VASC30MM	30 mm	0.71 oz.
VASC31MM	31 mm	0.74 oz.
VASC32MM	32 mm	0.74 oz.
VASC33MM	33 mm	0.78 oz.
VASC34MM	34 mm	0.78 oz.
VASC35MM	35 mm	0.78 oz.
VASC36MM	36 mm	0.81 oz.
VASC37MM	37 mm	0.81 oz.
VASC38MM	38 mm	0.85 oz.
VASC39MM	39 mm	0.85 oz.
VASC40MM	40 mm	0.92 oz.
VASC41MM	41 mm	0.92 oz.
VASC42MM	42 mm	0.92 oz.
VASC43MM	43 mm	0.95 oz.
VASC44MM	44 mm	0.95 oz.
VASC45MM	45 mm	0.99 oz.
VASC46MM	46 mm	0.99 oz.
VASC47MM	47 mm	1.02 oz.
VASC48MM	48 mm	1.09 oz.
VASC49MM	49 mm	1.09 oz.
VASC50MM	50 mm	1.09 oz.
VASC51MM	51 mm	1.09 oz.
VASC52MM	52 mm	1.13 oz.
VASC53MM	53 mm	1.13 oz.
VASC54MM	54 mm	1.13 oz.
VASC55MM	55 mm	1.13 oz.
VASC56MM	56 mm	1.16 oz.
VASC57MM	57 mm	1.16 oz.
VASC58MM	58 mm	1.23 oz.
VASC59MM	59 mm	1.23 oz.
VASC60MM	60 mm	1.27 oz.
VASC61MM	61 mm	1.27 oz.
VASC62MM	62 mm	1.31 oz.
VASC63MM	63 mm	1.34 oz.



- A new and innovative SwitchCover® scope lens covers have many new design features not found on other scope lens covers.
- The spring-loaded SwitchCover® scope lens cover quickly deploys open with a simple press. The SwitchCover® rotates 180° and then folds flat against the scope body.
- SwitchCover® has a unique mounting system for mounting onto a scope. It features a cam action lock lever for mounting on a scope.
- Can be mounted onto scopes, round reflex optics, binoculars, spotting scopes, or any optic with a round profile.
- SwitchCover® provides a good dust seal for the optic lenses.
- Currently available in over 34 different sizes.
- From 30mm to 63mm.
- Made from high-quality polymers.
- Proudly Designed in the USA
- **SwitchCover™ lens covers. PATENTS:**
- **US 9563050**
- **CA 2881921**
- **CN 201510067251**
- **EP 290808**

HANDGUN TOOLS

DESIGNED IN USA

UTK

ULTIMATE TOOL KIT FOR GLOCK®

MODEL# VTGUTK

1. GLOCK® PRO TOOL

Five specific tools for Glock® pistols: magnetic 3/16" hex nut driver for the front sight, channel liner removal and channel liner install tool, hardened steel 3/32" (2.5mm) disassembly tool, striker assembly holder, and flat blade and Phillips screwdriver tool bit.

2. UNIVERSAL PISTOL REAR SIGHT TOOL

Designed for: Removal, Installation, and Adjusting windage of dovetailed rear sights for most Semi-Auto Pistol slides.

3. MAGPOPPER

Designed to remove Glock® flat floorplates. It works with 10 rounds, standard capacity, and high capacity Glock® magazines.

4. GLOCK® POCKET TOOL

Hardened steel 3/32" or 2.5mm punch tool is designed to remove the pins and disassemble the Glock® frame, slide, and the magazine into their individual components. The opposite end of the tool includes a 3/16" hex nut driver for removing/installing factory and aftermarket Glock® front sights.

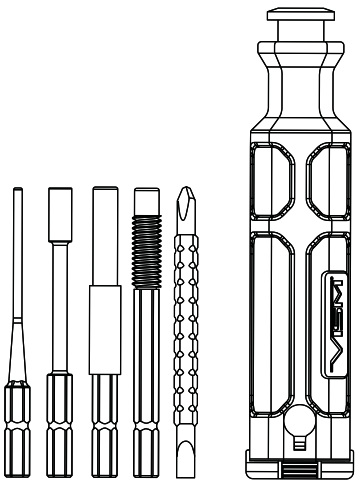

1.

GLOCK® PRO TOOL
US PATENT PENDING

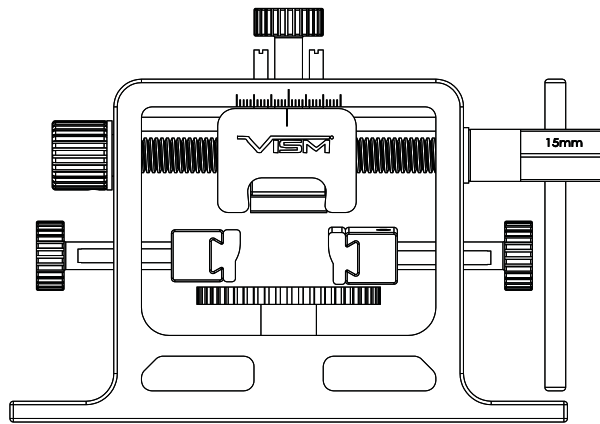

2.

UNIVERSAL PISTOL REAR SIGHT TOOL
US. PAT. 9784535 | US. PAT. D829294

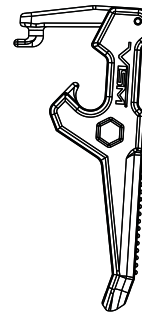

3.

MAGPOPPER
US PAT. D839377

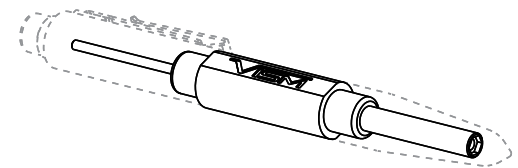

4.

GLOCK® POCKET TOOL

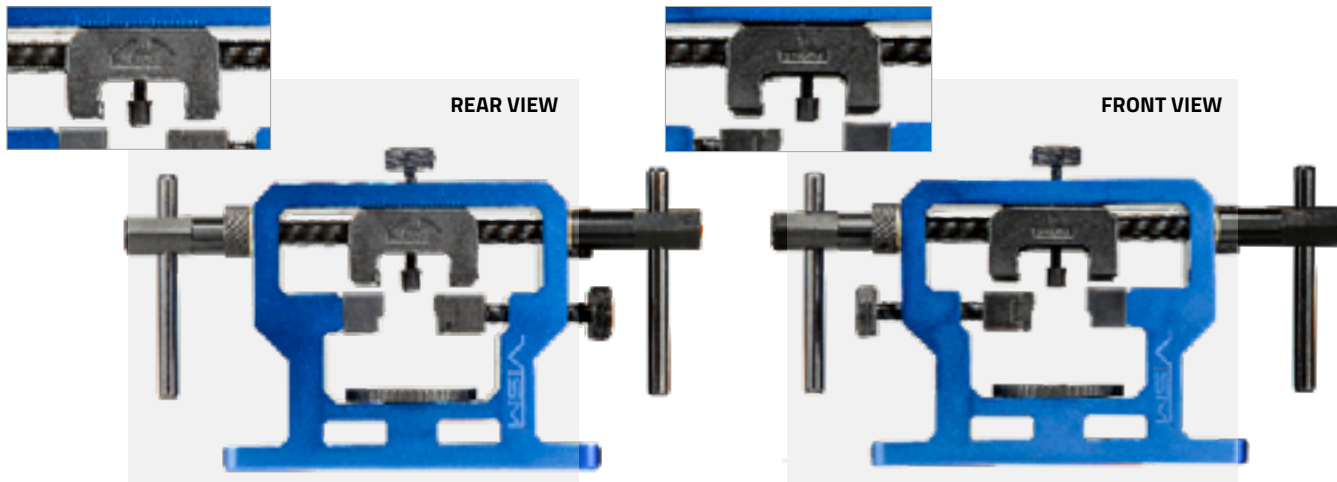

UNIVERSAL PISTOL FRONT & REAR SIGHT ADJUSTMENT TOOL

MODEL# VTUFNR

US PATENT: 9784535 , US PATENT PENDING

LENGTH	HEIGHT	DEPTH
8.3"	4.9"	1.9"

- Universal pistol front & rear sight pusher tool is for: removal, installation, and the adjustment of the front & rear sights for most semi-auto pistol slides.
- Heavy duty blue anodized aluminum frame with steel tools
- Side witness windows machined into both sides of tool frame to check for and verify proper tool and sight alignment.
- Pusher blocks are made from tool steel

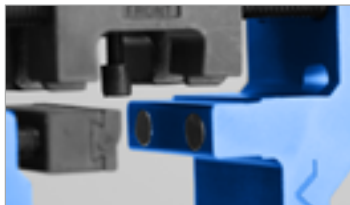

• Magnetic side support



• Top & side clamps

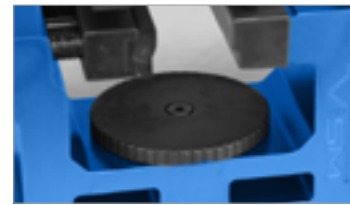

• Adjustable base platform



Multiple Vertical and Horizontal clamps to secure various sizes and types of semi-auto slides in the tool.



Sight tool frame can be bolted to, clamped onto work surface, or clamped into a work vice.



Base platform is adjustable for height, to get your slide and rear sights at the proper height for the rear sight pusher. Includes one bottom spacer for some pocket pistol slides for proper height alignment.



DESIGNED IN USA

UNIVERSAL PISTOL REAR SIGHT TOOL

MODEL# VTUPRS

US PATENT: D829294, US 9784535

LENGTH	HEIGHT	DEPTH
7.0"	4.7"	2.0"

- Used for: removal, installation, and adjusting windage of dovetailed rear sights for most semi-auto pistol slides.
- Heavy duty blue anodized aluminum frame with steel tools
- Side witness windows machined into both sides of tool frame to check for and verify proper tool and rear sight alignment.

WORKS WITH MANY TYPES OF SEMI-AUTO SLIDES:
Full Size Pistols | Compact Pistols
Sub Compact Pistols | Pocket Sized Semi-Auto Pistols.

HANDGUN TOOLS

DESIGNED IN USA

GLOCK® PRO TOOL

MODEL# VTGLPRO

US PATENT PENDING

LENGTH	WEIGHT
7.5"	5.0 oz.

Five specific tools for GLOCK® pistols.
Quick change tool bits included:

- Hardened steel 3/32" (2.5mm) disassembly tool
- Magnetic 3/16" hex nut driver for the front sight
- Channel liner removal tool
- Channel liner install tool
- The tool handle has a cavity for holding the firing pin and spacer in place for easier assembly/disassembly of the firing pin spring and spring cups.
- Flat blade and Phillips screwdriver bit.
- Handle has rubberized textured panels
- Tool bits can be stored inside the hollow handle.
- Polymer and steel construction.

*GLOCK® is a trademark of GLOCK, Inc



DESIGNED IN USA

GLOCK® POCKET TOOL - DISASSEMBLY & FRONT SIGHT TOOL FOR GLOCK®

MODEL# VTGLKPBL

LENGTH	WEIGHT
6.1"	2.2 oz.

1. Steel 3/32" (2.5mm) disassembly tool for GLOCK® pistols.
2. Magnetic 3/16" hex nut driver for the front sight
3. Blue anodized aluminum construction with threaded caps and steel pocket clip.

*GLOCK® is a trademark of GLOCK, Inc



DESIGNED IN USA

G5+ GLOCK® POCKET TOOL

MODEL# VTGLK5

US PATENT PENDING

LENGTH	WEIGHT
5.1"	5.2 oz.

- Hardened steel 3/32" (2.5mm) disassembly tool
- MagPopper magazine tool
- Magnetic 3/16" hex nut driver front sight tool
- GLOCK® striker assembly holder tool
- Corners of the handle help center the pins in the frame
- Plus a bottle opener
- Constructed of steel

*GLOCK® is a trademark of GLOCK, Inc



DESIGNED IN USA

1911 PRO TOOL

MODEL# VT1911

US PATENT PENDING

LENGTH	WEIGHT
7.4"	4.2 oz.

- Dual head 1911 barrel bushing wrench for both the Government and Officer's models.
- Barrel bushing tool is made from polymer and it will not scratch the finish of your 1911 barrel bushing or barrel.
- Includes 4 each 1/4" driver tool bits for working on your 1911.
- 3/32" Allen hex head driver tool bit for grip panel bolts.
- T10 Torx head driver tool bit for grip panel bolts.
- 3/16" flat head screw driver tool bit for grip panel screws & bushings.
- Standard Philips head screw driver tool bit.
- The 4 screw driver bits can be stored into the 1911 Pro Tool handle.
- Handle has rubberized textured panels for a sure grip and comfort.



DESIGNED IN USA

MAGPOPPER DISASSEMBLY TOOL FOR GLOCK® MAGAZINES

MODEL# VTGLMAG

US PATENT: D839377

LENGTH	WEIGHT
3.3"	2.6 oz.

- This innovative tool will help you take down your GLOCK® magazines in seconds
- Simple to use design: mount the MagPopper into the take down hole of the magazine floor plate, and align the lever. Squeeze the lever and the magazine together, and the floor plate effortlessly pops off.
- 1/4" tool bit holder designed into the side of the tool
- Slim design allows for convenient storage
- Also doubles as a bottle opener
- Constructed of steel

*GLOCK® is a trademark of GLOCK, Inc



AR TOOLS

NEW DESIGNED IN USA



ULTIMATE TOOL KIT FOR AR15

MODEL# VTARUTK



- 1. UPPER RECEIVER BLOCK FOR AR15**
A modular AR15/M4 upper receiver block for performing work on your upper receiver.
- 2. AR15/M4 HANDGUARD REMOVAL TOOL**
AR15/M4 GI handguard removal tool. Works with rifle, carbine, & mid-length handguards. Hook end goes into the magazine well and the two arms slip over the Delta ring for leveraging against the Delta ring spring for the removal of two-piece top/bottom plastic type handguards.
- 3. MAGAZINE WELL LOWER RECEIVER VICE BLOCK**
Block can be inserted into the 5.5/.223 type magazine wells and can attach to a vice.
- 4. PRO SERIES AR15 BARREL WRENCH**
Heavy duty barrel wrench works with MIL-SPEC barrel nuts for installation or removal of the barrel and free float handguards with the same hole spacing.
- 5. PRO SERIES AR LOWER RECEIVER WRENCH**
Heavy duty castle nut wrench for M4 MIL-SPEC and commercial type collapsible stock buffer tubes.
- 6. AR15/M4 A1 & A2 FRONT SIGHT ADJUSTMENT TOOL**
Works with both A1 (5 prong) and A2 (4 prong) type front sight posts for zeroing your iron sights.



1.
UPPER RECEIVER BLOCK FOR AR15
US PATENT PENDING



2.
AR15/M4 HANDGUARD REMOVAL TOOL



3.
MAGAZINE WELL LOWER RECEIVER VICE BLOCK



4.
PRO SERIES AR15 BARREL WRENCH
US PATENT: D798121



5.
PRO SERIES AR LOWER RECEIVER WRENCH
US PATENT: D803020



6.
AR15/M4 A1 & A2 FRONT SIGHT ADJUSTMENT TOOL

Hand Tools:

5/64" steel punch - Gas Tube roll pin tool
3/32" steel punch - Bolt Catch roll pin tool
1/8" steel punch - Trigger Guard roll pin tool



Mallet with nylon and brass ends and wooden handle



1/4" Hex screw driver handle with 5 each 1/4" Hex driver tool bits



Nylon cleaning brush with broad and narrow bristle brush heads





DESIGNED IN USA

UPPER RECEIVER BLOCK FOR AR15

MODEL# VTARUVB

US PATENT: D870840

LENGTH	WIDTH	HEIGHT	WEIGHT
7.4"	2.0"	3.1"	23.4 oz.

- Slide the top half of the block into your upper, and bolt the lower and upper block together to secure the upper receiver.
- Use for installation and removal of your barrel, free float handguard, muzzle brake, etc.
- Two steel receiver pins are included to mount your standard mil-spec upper AR15 receiver to the block.
- The Upper Receiver Block also doubles as a bore cleaning guide for proper bore alignment with your cleaning rod.
- Constructed of anodized aluminum

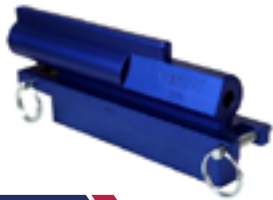

DESIGNED IN USA

AR10 UPPER RECEIVER BLOCK

MODEL# VTAR10UVB

US PATENT PENDING

LENGTH	HEIGHT	DEPTH
8.4"	3.1"	2.0"

- Used for the installation and removal of barrel, handguards, muzzle brakes, gas blocks, mounting optics, cleaning, etc.
- Doubles as a bore cleaning guide for proper bore alignment with your cleaning rod and brush
- Two receiver pins included for mounting the lower support block to your AR10 upper receiver for easy mounting of the receiver to a vice.
- Constructed of anodized aluminum



AR15 ARMORER'S BARREL WRENCH

MODEL# TARW

US PATENT: D598723

LENGTH	HEIGHT	DEPTH
13.0"	2.1"	0.6"

- Barrel Nut Wrench
- A1 Flash Hider Slot
- M4 Buffer Tube Castle Nut
- Flat Blade Screw Driver
- Receiver Tube Stock Nut Wrench "Old Style" 1 Point
- A2 Flash Hider Slot
- 1/2" Drive

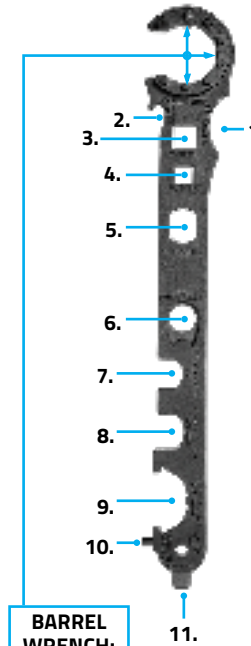

AR TOOLS

DESIGNED IN USA

AR15 ARMORER'S BARREL WRENCH GEN II

MODEL# TARW2

US PATENT: D703502

LENGTH	HEIGHT	DEPTH
12.9"	2.0"	0.6"

- BARREL WRENCH - 1.75" Spanner Wrench (YHM Type Barrel Nut)
- Tactical Bottle Opener
- 1/2" Drive
- 3/8" Drive
- A2 Buffer Tube
- 1911 Barrel Bushing Wrench
- 5/8" Muzzle Device/A2 Buffer Tube
- 3/4" Muzzle Device
- M4 Buffer Tube Castle Nut
- Lower Receiver Push Pin Tool
- Flat Blade Screw Driver

BARREL WRENCH:

- MIL-SPEC Barrel Nut
- Free-Float Handguards (with MIL-SPEC Barrel Nut Hole Spacing)
- DD Type Barrel Nut



DESIGNED IN USA

AR UPPER RECEIVER WRENCH

MODEL# VTARW3

US PATENT: D798121

LENGTH	WEIGHT
12.5"	23.0 oz.

- AR Barrel Nut Wrench
- 1/2" Drive
- 3/8" Drive
- Heavy duty ergonomic handle
- AR Muzzle Brake Wrench

PROSERIES

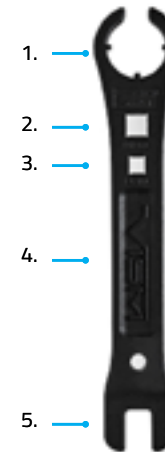

DESIGNED IN USA

AR LOWER RECEIVER WRENCH

MODEL# VTARW4

US PATENT: D803020

LENGTH	WEIGHT
10.5"	18.0 oz.

- M4 Castle Nut Wrench
- 1/2" Drive
- 3/8" Drive
- Heavy duty ergonomic handle
- A2 Buffer Tube Wrench

PROSERIES

AR TOOLS



AR15/M4 HANDGUARD REMOVAL TOOL

MODEL# TARHR

- This tool makes it easy for one person to handle the sometimes difficult task of removing or installing GI Handguards
- Works with rifle, carbine, & mid-length handguards. Tool end goes into the mag well and the arms slips over the delta Ring
- With some easy leveraging that compresses the delta ring with a single hand, frees up your other hand to remove/install handguards
- Steel construction with a protective non-marring plastic coating
- Length: 10.6"
- Weight: 5.9 oz



AR15 A1 & A2 FRONT SIGHT ADJUSTMENT TOOL

MODEL# TARFSC

- A1 (5 prong) and A2 (4 prong) front sight adjustment tool
- Steel construction
- Length: 2.2"
- Weight: 0.8 oz

DESIGNED IN USA

AR15/M4 GUNSMITHING TOOL KIT WITH ROLL-UP CLEANING MAT

MODEL# TGSARKT - TAN
MODEL# TGSARKB - BLACK

ROLLED-UP DIMENSIONS:
15.0"L x 3.0"H X 3.0"D



Tools are subject to change without notice



EXTENDED DIMENSIONS:
36" x 29"

KIT INCLUDES:



STEEL PUNCHES:

- 5/64" Gas Tube roll pin tool
- 3/32" Bolt Catch roll pin tool
- 1/8" Trigger Guard roll pin tool



BRASS PUNCHES:

- 1/4" Brass Punch
- 5/16" Brass Punch



PLASTIC PUNCHES:

- 7/32" Plastic Punch
- 5/16" Plastic Punch



AR15/M4 HANDGUARD REMOVAL TOOL (TARHR)



NYLON CLEANING BRUSH

- Broad and Narrow bristle brush heads



AR15/M4 ARMORER'S WRENCH GEN II (TARW2)

- Various types of barrel nut, castle nut, muzzle brake, buffer tube wrenches and more!



MALLET

- Brass & Nylon Hammer with Wooden Handle



FRONT SIGHT ADJUSTMENT TOOL

- AR15/M4 A1 & A2 (TARFSC)



ESSENTIAL GUNSMITH TOOL KIT

MODEL# TGSETK

DIMENSIONS:
15.5"L x 10.5"H X 3.2"D

Tools are subject to change without notice



KIT INCLUDES:



30PCS 1/4" SCREW BIT SET

- Flat Blade (mm): 3,4,5,5.5,6,7
- Phillips: PH0, PH1, PH2, PH3, PZ0, Z1, PZ2, PZ3
- Hex: H3, H4, H5, H6
- Torx: T10, T15, T20, T25, T27, T30, T40
- 1/4" Hex Bit to 1/4" Socket Adapter
- Square: S1, S2, S3

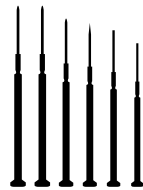

6 PCS JEWELERS' SCREW DRIVERS SET:

- Flat Blade (mm) : 1.4, 2.0, 2.4, 3.0
- Phillips: #0, #1



SCREW DRIVER HANDLE WITH 1/4" HEX DRIVER

Length: 7.4"



2 PCS POLYMER PUNCH SET:

- Polymer Drift Punch: 7/32", 5/16"



TRIANGLE FILE

Length: 7.7"

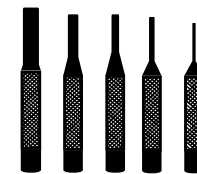

5 PCS BRASS PUNCH SET

- Brass Drift Punch: 1/8", 5/32", 7/32", 1/4", 5/16"

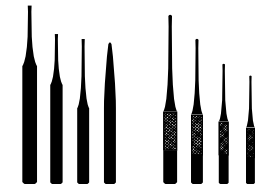

8 PCS STEEL PUNCH SET

- Roll Pin Drift Punch - 3/32", 1/8", 3/16", 1/4",
- Drift Punch - 3/32", 1/8", 3/16",
- Center Punch - 4.8"L



SAFETY GLASSES

- Polycarbonate Lenses

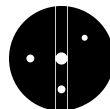

GUNSMITH BENCH BLOCK:

- Nylon Diameter 4"



NEEDLE NOSE PLIER:

Length: 4.5"



MALLET WITH NYLON & BRASS ENDS

Length: 11"

MAG LOADER & STRIPPER CLIPS

- 1/4" Tool Bit Holder
- T-Handle Cartridge Pusher
- Blue Nylon Tether
- Speed Loader Main Body
- Magazine Catch
- Ammo Tray Door
- Magazine Release Button
- Magazine Tray Latch
- Magazine Well
- Stripper Clip Magnet Extractor

COMPATIBLE CARTRIDGES

- .223 REM
- 5.56mm NATO
- M855A1
- 300 AAC Blackout
- .224 Valkyrie
- 6.8 SPC

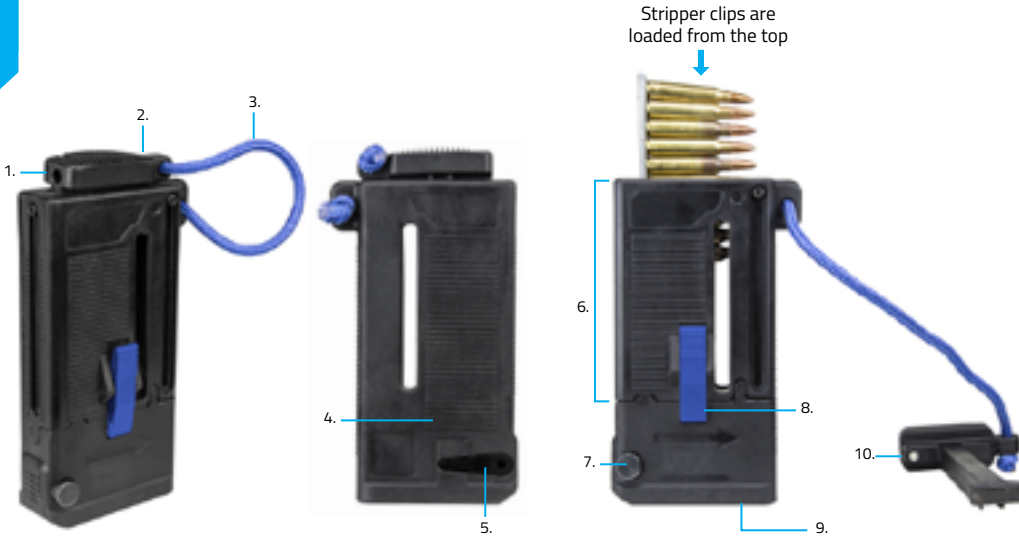

DESIGNED IN USA

AR15/M4 MAGAZINE SPEED LOADER VIA STRIPPER CLIPS OR LOOSE ROUNDS

MODEL# AARLAV2

US PATENT 6754987, US PATENT PENDING

HEIGHT	WIDTH	DEPTH	WEIGHT
7.0"	3.75"	1.5"	13.7 oz.

- AR-15/M4/M16 Speed Loader works with metal and polymer magazines. Magazines will securely lock into Speed Loader with the integrated magazine catch.
- Speed Loader works with GI 10 round stripper clips or you can load 10 loose rounds into the side tray that opens up for easy access. Side tray door is secured with a spring loaded latch.
- When the Speed Loader is loaded up with 10 rounds, insert the tethered T-handle push rod into the top of the loader and push the cartridges into the magazine. Load up another 10 or so cartridges until the magazine is at capacity.
- The T-handle push rod has several features: a magnet on the T-handle retains the empty stripper clip for easy removal, the end of T-handle push rod will also strip the cartridges from the feed lips of a loaded magazine, it has a 1/4" tool bit holder molded into the handle, the handle is tethered to the Speed Loader body with a blue lanyard.
- Speed Loader is constructed of polymer and aluminum.



.223/ 5.56X45 STRIPPER CLIPS

MODEL# AARC

20 PCS

- Holds 10 rounds
- Steel Construction
- Length: 4.0"
- Weight: 0.3 oz. (per clip)



.308/ 7.62X51 STRIPPER CLIPS

MODEL# AFNC

20 PCS

- Holds 10 rounds
- Steel Construction
- Length: 4.9"
- Weight 0.6 oz (per clip)



7.62X39 STRIPPER CLIPS

MODEL# AAKC

20 PCS

- Holds 10 rounds
- Steel Construction
- Length: 4.9"
- Weight: 0.4 oz. (per clip)



7.62X54R STRIPPER CLIPS

MODEL# AMNC

10 PCS

- Holds 5 rounds
- Steel Construction
- Length: 2.6"
- Weight: 0.3 oz. (per clip)

NEW DESIGNED IN USA

AK MAGAZINE SPEED LOADER VERSION 2 VIA STRIPPER CLIPS OR LOOSE ROUNDS

MODEL# AAKLAV2

US PATENT 6754987, US PATENT PENDING

HEIGHT	WIDTH	DEPTH	WEIGHT
9.0"	5.0"	1.75"	17.5 oz.

- AK Speed Loader Version 2 is designed for AK 7.62 X 39mm type magazines.
- The AK Speed Loader will load magazines with AK 10 round stripper clips (NcSTAR AAKC AK stripper clips) or you can load up to 10 individual 7.62 X 39mm cartridges at a time onto the ammo tray, which is accessible from a sliding tray door.
- AK type magazines (both polymer and metal mags) securely attach to the AK Speed Loader via a spring loaded metal magazine catch & release lever.
- T-Handle cartridge pusher easily and effortlessly pushes up to 10 rounds into the magazine at a time. The cartridge pusher is tethered to the AK Speed loader with a blue nylon cord.
- The cartridge pusher has a magnet imbedded into the T-Handle to extract empty steel AK Stripper clips from the AK Speed Loader.



DESIGNED IN USA

S&W® M&P 15-22® KEYMOD® FREE FLOAT HANDGUARDS

10.0"	CARBINE LENGTH	MODEL# VMP22FFKMC
13.0"	MID- LENGTH	MODEL# VMP22FFKMM
15.0"	RIFLE LENGTH	MODEL# VMP22FFKMR



- Smith & Wesson® M&P® 15-22 .22LR KeyMod® Free Float Handguards - 10" Length
- Low Profile and Light Weight Octagon shaped M&P® 15-22 KeyMod® handguard. Top surface is a Picatinny Rail at AR15 receiver height. The other 7 sides are KeyMod® slots.
- Includes M&P® 15-22 Barrel Nut Wrench & Free Float Barrel Nut, Handguard Adapter Insert, Handguard Spacer, Short & Medium KeyMod® to Picatinny Accessory Rails, main Handguard Tube in 10" Length
- Top Picatinny Rails have Laser Engraved T-Slot Numbers.
- Black anodized aluminum construction.
- US PATENT 9939228

DESIGNED IN USA

S&W® M&P 15-22® BARREL NUT WRENCH

MODEL# TMP1522



- Quickly and easily remove the factory barrel nut on the Smith & Wesson® M&P 15-22®
- Allows you to add a free float handguard to your Smith & Wesson® M&P 15-22®
- The lugs are designed to fit snugly, to keep the nut from getting damaged.
- The inside of the wrench will fit over most standard A1 and A2 flash hiders.

SPECIFICATIONS	
LENGTH	11.0"
NET WEIGHT	6.9 oz.

AK CLEANING ROD REPLACEMENT

MODEL# TAKR



- Fits AK-47/ AKM 7.62/.30 cal bores
- Factory replacement for missing or lost cleaning rods
- Steel construction

SPECIFICATIONS	
LENGTH	15.7"L x 0.2"H X 0.2"D
NET WEIGHT	2.1 oz.

SKS CLEANING ROD REPLACEMENT

MODEL# TSKSR



- Fits SKS 7.62/.30 cal bores
- Factory replacement for missing or lost cleaning rods
- Steel construction

SPECIFICATIONS	
LENGTH	17.0"L x 0.2"H X 0.2"D
NET WEIGHT	2.2 oz.

AK/SKS FRONT SIGHT ADJUSTMENT TOOL

MODEL# TAK

- Two-piece front sight adjustment tool
- T-handle has a slot which interfaces with the front sight post to adjust the front sight's elevation
- Combined, the tool will move the front sight barrel left or right for adjusting the front sight's windage
- Steel construction



SPECIFICATIONS	
LENGTH	2.7"
NET WEIGHT	4.9 oz.

SKS RECEIVER COVER TAKE DOWN PIN

MODEL# ASKSP

- SKS replacement receiver cover take-down pin.
- Steel Construction



SPECIFICATIONS	
LENGTH	1.3"
NET WEIGHT	0.3 oz.

CLEANING TOOLS



5.56/.223 BARREL BORE BRUSH W/MIL-SPEC THREAD

MODEL# TBB223

LENGTH	WEIGHT
3.3"	0.2 oz.

- G.I. bore brush replacement.
- Works with G.I. cleaning rods/ kits/ threads.
- Cleans .22 caliber barrel bores.
- Bronze bristles to remove carbon, powder, and bullet residue, but it will not damage bore.



.308 WIN CHAMBER BRUSH RATCHETING

MODEL# TBC308

LENGTH	WEIGHT
3.3"	0.5oz

- .308 WIN bronze bristle chamber brush
- Ratcheting (GI style)
- Fits into .308 WIN chambers, has plastic ratcheting gears
- Use GI cleaning rod to quickly ratchet the chamber brush



AR15 CHAMBER BRUSH G.I. ROD THREAD

MODEL# TBCAR15

LENGTH	WEIGHT
3.6"	0.3 oz.

- AR15 bronze bristle chamber brush with steel bristles for locking lugs
- GI cleaning rod threading (not commercial threading)
- Use M16 GI cleaning rods (not included) to clean the .223/5.56 chamber and locking lugs



UNIVERSAL CLEANING KIT PISTOL | RIFLE | SHOTGUN

MODEL# TUGCKA

LENGTH	HEIGHT	DEPTH	WEIGHT
11.8"	8.4"	2.2"	31.6 oz.

- 2 sets of cleaning rods, one for pistol & rifle accessories and the other for shotgun accessories
- 2 Rod adapters, plastic T-handle for a sure grip, 2 slotted tips for patches, and cleaning patches
- 10 bronze bore brushes
- 5 bore mops
- Aluminum carrying case with latches and carry handle

LASER BORE SIGHTERS



.03-06 LASER CARTRIDGE BORE SIGHTER

MODEL# TLZ3006

LENGTH	WEIGHT
2.5"	0.6 oz.



12 GAUGE LASER CARTRIDGE BORE SIGHTER

MODEL# TLZ12G

LENGTH	WEIGHT
2.4"	1.7 oz.



.223 REM LASER CARTRIDGE BORE SIGHTER

MODEL# TLZ223

LENGTH	WEIGHT
1.8"	0.3 oz.



7.62X39 LASER CARTRIDGE BORE SIGHTER

MODEL# TLZ762

LENGTH	WEIGHT
1.7"	0.3 oz.



.308 WIN LASER CARTRIDGE BORE SIGHTER

MODEL# TLZ308

LENGTH	WEIGHT
1.8"	0.4 oz.



RED LASER 635-655nm
<5mW, CLASS IIIa



LASER CARTRIDGE BORE SIGHTER KIT [4 CARTRIDGES]

MODEL# TLZSET

LENGTH	HEIGHT	DEPTH	WEIGHT
6.0"	3.8"	1.1"	4.0oz.

- Includes 4 red laser cartridges: 7mm Rem Mag, 30-06, .308 Win, .223 Rem
- Includes soft carry case and 12 Batteries 4 sets of 3 batteries).
- Cartridges made from aluminum, except the .223 cartridge which is made from brass
- With these 4 laser cartridges, you can bore sight up to 20 different Calibers
- .30-06 works with these chambers: 25-06 Rem, .270 Win, .35 Whelen
- .308 Win works with these chambers: .243 Win, .260 Rem, 7.62X51 NATO, .358 Win, 7mm-08
- .223 Rem works with these chambers: 5.56X45 NATO



RED LASER
635-655nm <5mW, CLASS IIIa



RED & GREEN DOT OPTIC

MODEL# DAB

- LED 100% safe for the eyes
- Unlimited eye relief
- Fully adjustable (windage & elevation)
- 3 brightness settings for red and green dot
- Interchangeable Weaver & 3/8 Dovetail mount
- Includes spare Battery and Mounting Tools
- Black anodized aluminum

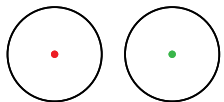

RED DOT GREEN DOT



RED DOT OPTIC

BLACK - MODEL# DPV2

TAN - MODEL# DPTV2

ALUMINUM CONSTRUCTION

- LED 100% safe for the eyes
- Unlimited eye relief
- Fully adjustable (windage & elevation)
- Integrated mounting base fits virtually any Weaver/Picatinny type rails
- Includes extra battery and mounting tool
- Black anodized aluminum



RED DOT



RED DOT OPTIC

WEAVER MOUNT - MODEL# DP

3/8 DOVETAIL MOUNT- MODEL# DP38

POLYMER CONSTRUCTION

- LED 100% safe for the eyes
- Unlimited eye relief
- Fully adjustable (windage & elevation)
- Integrated mounting base fits virtually any Weaver/Picatinny type rails (DP) and 3/8" Dovetail mount (DP38)
- Includes extra battery and mounting tool



RED DOT



DESIGNED IN USA

SPD SOLAR FLIPDOT (KPM)

MODEL# VDBSOLFLIP

US PATENT: D846690

- Dual power source; it can be powered by the sun via the top mounted solar panel or the included onboard battery.
- Fully adjustable for windage and elevation.
- Can be mounted onto: Picatinny/MIL-STD 1913 rails, KeyMod™, and M-LOK® slots.
- Flip up lens deploys using ambidextrous levers. Folds down flat when not in use.
- Includes extra battery, micro dot cover, and mounting/ adjustment tools
- Black anodized aluminum



RED DOT

SPECIFICATIONS	DPV2	DPTV2	DAB	DP	DP38	VDBSOL130
MAGNIFICATION	1X	1X	1X	1X	1X	1X
OBJECTIVE LENS DIAMETER	24 x 34 mm	24 x 34 mm	25 mm	24 x 34 mm	24 x 34 mm	32mm x24mm
DOT SIZE	3 MOA	3 MOA	5 MOA	3 MOA	3 MOA	2 MOA
WEIGHT (oz.)	4.0 oz	4.0 oz	4.4 Voz	2.1 oz	2.1 oz	6.3 oz
OVERALL LENGTH (in)	4.7"	4.7"	4.0"	4.7"	4.7"	3.5"
CLICK VALUE @ 100 YDS	1 MOA	1 MOA	1 MOA	1 MOA	1 MOA	1 MOA
ILLUMINATION	Red	Red	Red/ Green	Red	Red	Red
LENS COATING	Platinum	Platinum	Platinum	Platinum	Platinum	Ruby
DIMENSIONS	4.7"L x 2.2"H x 1.4"D	4.7"L x 2.2"H x 1.4"D	4.0"L x 2.2"H x 1.5"D	4.7"L x 2.2"H x 1.6"D	4.7"L x 2.2"H x 1.6"D	3.5"L X 1.9"W X 2.5"H

Adjust the brightness level up or down when powered by the battery, via the side + & - buttons.

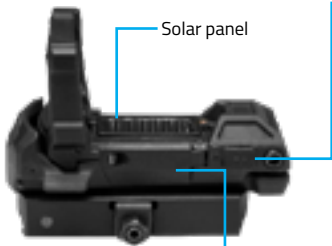

Powered by one CR2032 battery (included)

HEADS UP



DESIGNED IN USA

4 RETICLE REFLEX WITH
KEYMOD™ QR MOUNT

- **RED RETICLES** - MODEL# VD4BKM
US PATENT: 9341441
- LED 100% safe for the eyes
- Unlimited eye relief for flexible mounting
- 7 brightness settings
- Includes adjustment tool
- Rubber lens cap
- KeyMod™ locking quick release mount
- Powered by CR2032 battery (included)



4 RETICLE REFLEX

- **RED RETICLES** - MODEL# D4B
- LED 100% safe for the eyes
- Unlimited eye relief
- 7 brightness settings
- Tools to adjust reflex optics zero are included
- Rubber Lens cap
- Powered by CR2032 battery (included)
- Clamp On Weaver/Picatinny rail mount

4 RETICLE REFLEX
RED/ GREEN RETICLES

- **BLACK** - MODEL# D4RGB
- **TAN** - MODEL# D4RGT
- LED 100% safe for the eyes
- Unlimited eye relief
- 5 brightness settings for each reticle color
- Includes adjustment tool
- Rubber lens cap
- Powered by CR2032 battery (included)
- Clamp On Weaver/Picatinny rail mount



DESIGNED IN USA

4 RETICLE REFLEX QR MOUNT

- **RED/ GREEN RETICLES** - MODEL# D4RGBQ
- LED 100% safe for the eyes
- Unlimited eye relief
- 5 brightness settings for each reticle color
- Tools to adjust reflex optics zero are included
- Rubber Lens cap
- Locking quick release mount for mounting onto Weaver/ Picatinny type rails

DESIGNED IN USA

4 RETICLE REFLEX QR MOUNT

- **RED RETICLES** - MODEL# D4BQ
- **BLUE RETICLES** - MODEL# D4BLQ
- LED 100% safe for the eyes
- Unlimited eye relief
- 7 brightness settings
- Tools to adjust reflex optics zero are included
- Rubber lens cap
- Locking quick release mount for mounting onto Weaver/ Picatinny type rails



REFLEX SIGHTS INCLUDES:

4 RETICLES

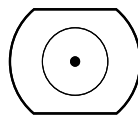

BULLSEYE

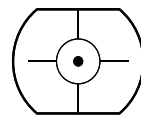

STAR BURST

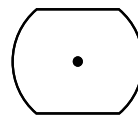

DOT

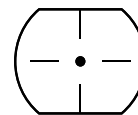

CROSS

SELECTOR
SWITCH

Selector switch at the back of the optic, allows you to select the desired reticle.

SPECIFICATIONS	D4B	D4BLQ	D4BQ	D4RGBQ	D4RGT	D4RGB	VD4BKM
MAGNIFICATION	1X	1x	1x	1X	1X	1X	1X
OBJECTIVE LENS DIAMETER	24x34mm	24x34mm	24x34mm	24x34mm	24x34mm	24x34mm	24x34mm
DOT SIZE	3 MOA	3 MOA	3 MOA	3 MOA	3 MOA	3 MOA	3 MOA
WEIGHT (oz.)	4.3 oz	5.2 oz	5.2 oz	5.2 oz	4.3 oz	4.3 oz	3.4 oz
OVERALL LENGTH (in)	3.1"	3.2"	3.2"	3.2"	3.3"	3.3"	3.3"
CLICK VALUE @ 100 YDS	1 MOA	1 MOA	1 MOA	1 MOA	1 MOA	1 MOA	1 MOA
ILLUMINATION	Red	Blue	Red	Red/Green	Red/Green	Red/Green	Red
LENS COATING	Ruby	Platinum	Ruby	Platinum	Platinum	Platinum	Ruby
DIMENSIONS	3.1" L x 2.1" H x 1.5" D	3.2" L x 2.1" H x 2.0" D			3.3" L x 2.2" H x 1.4" D		3.3" L x 1.9" H x 1.4" D

DESIGNED IN USA

MICRO RED & BLUE DOT

MODEL# VDBRB

US PATENT: D765212

- LED 100% safe for the eyes
- Unlimited eye relief
- Fully adjustable red & blue dot
- 5 brightness settings for the Red/Blue dot
- Attaches to virtually any Weaver/Picatinny/MIL-STD 1913 rails
- Includes lens covers
- Powered by CR123A lithium battery (included)

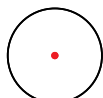

RED DOT

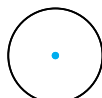

BLUE DOT



ELECTRONIC CONTROL PANEL

RED/GREEN DOT REFLEX OPTIC

MODEL# DMRG130

- LED 100% safe for the eyes
- Unlimited eye relief
- Fully adjustable red & green dot (windage & elevation)
- 5 Brightness Settings for each color
- Includes 30mm cantilever Weaver/Picatinny mount
- See-through flip-up lens covers included
- Powered by CR2032 battery (included)

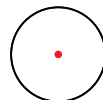

RED DOT

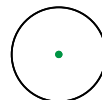

GREEN DOT

RED DOT REFLEX OPTIC

MODEL# DP130

POLYMER CONSTRUCTION

- LED 100% safe for the eyes
- Unlimited eye relief
- Fully adjustable red dot (windage & elevation)
- See-through flip-up lens covers included
- Powered by three LR44 batteries (included)

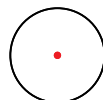

RED DOT



DESIGNED IN USA

ADVANCED - 4 RETICLES

MARK III
TACTICAL SERIES
REFLEX OPTIC

4 RETICLES REFLEX OPTIC (ADVANCED)

MODEL# DMRK132A

- LED 100% safe for the eyes
- Unlimited eye relief
- 3 brightness Levels and 3 different colors: Red, Green, and Blue for each of the 4 Reticles
- Fully adjustable (windage & elevation)
- Locking quick release attaches to virtually any Weaver/Picatinny/ MIL-STD 1913 rails
- Powered by CR2032 battery (included)

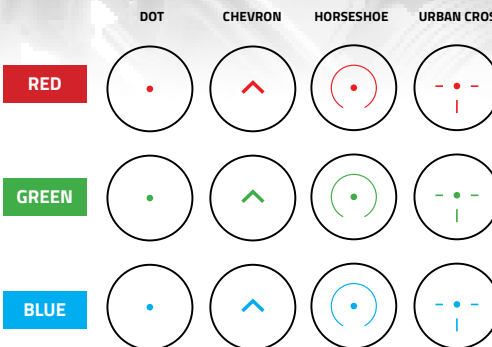

SPECIFICATIONS	DMRG130	DP130	VDBRB	DMRK132A
MAGNIFICATION	1x	1X	1X	1X
OBJECTIVE LENS DIAMETER	30 mm	30 mm	25 mm	32 mm
DOT SIZE	3 MOA	5 MOA	3 MOA	3 MOA
WEIGHT (oz.)	7.0 oz	3.6 oz	6.2 oz	9.9 oz
OVERALL LENGTH (in)	4.5"	5.0"	2.6"	5.4"
CLICK VALUE @ 100 YDS	0.5 MOA	1 MOA	1 MOA	-
ILLUMINATION	Red/ Green	Red	Red/Blue	Red/ Green / Blue
LENS COATING	Platinum	Ruby	Platinum	Platinum
DIMENSIONS	4.5"L x 2.9"H x 2.3"D	5.0"L x 2.2"H x 1.8"D	2.6"L x 2.8"H x 1.9"D	5.4"L x 2.8"H x 2.3"D

SMALL TUBE



INCLUDES
A low rail mount for mounting onto weaver/ Picatinny/ MIL-STD 1913 type rails.

DESIGNED IN USA

SPD COMBAT

MODEL# VDBSOLC

PATENT:
US 9563050, CA 2881921, CN 201510067251, EP 2908084, PATENT PENDING

- Optic has dual power modes. It can run off the Sun via the Solar Cells on top of the optic, or the onboard AAA Battery (included).
- Five brightness settings for the red dot reticle, in battery mode.
- Unlimited eye relief for flexible mounting positions on the firearm.
- Includes a low rail mount and a high quick release rail mount for mounting onto weaver/ Picatinny/ MIL-STD 1913 type rails.
- The base of the optic is compatible with most Aimpoint® Micro Mounts.
- Optic includes our Patented SwitchCover™ lens covers.

- A) Solar Cells
- B) Elevation adjustment turret & cap
- C) Battery Cap & Compartment

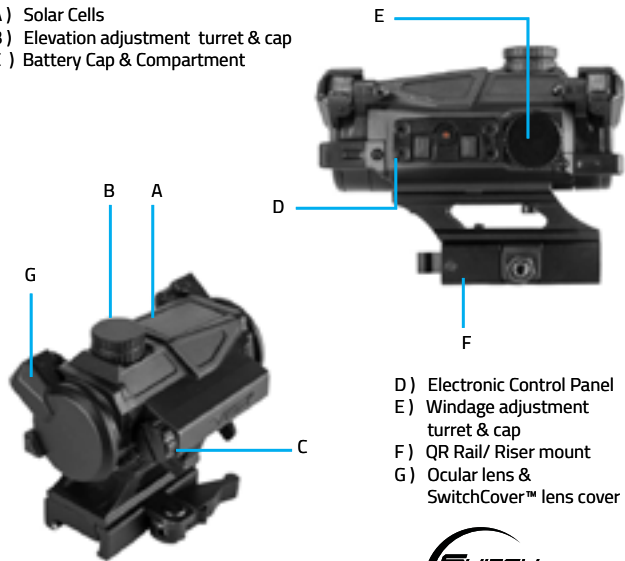

- D) Electronic Control Panel
- E) Windage adjustment turret & cap
- F) QR Rail/ Riser mount
- G) Ocular lens & SwitchCover™ lens cover



DESIGNED IN USA

SPD SOLAR RED REFLEX SIGHT

MODEL# VDBSOL130

US PATENT: D856458

- LED 100% safe for the eyes
- Unlimited eye relief
- Dual Power Source : Solar & battery operated (AA)
- 2 MOA red dot has 5 levels of brightness
- Locking quick release mount fits Weaver and Picatinny rails
- Optics centerline at 1.5" AR15 Height



Solar panel
Powered by one AA battery (included)

5 levels of brightness

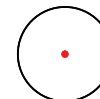

RED DOT

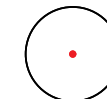

RED DOT

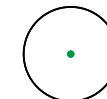

GREEN DOT

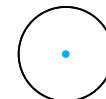

BLUE DOT

35MM RED/GREEN/BLUE DOT OPTIC

BLACK - MODEL# DRGB135

TAN - MODEL# DRGB135T

URBAN GRAY - MODEL# DRGB135U

- LED 100% safe for the eyes
- Unlimited eye relief
- Fully adjustable (windage & elevation)
- Rheostat knob with 3 brightness
- Levels for each of the red, green, and blue dot reticles
- Attaches to virtually any Weaver/ Picatinny/MIL-STD 1913 rails
- Powered by CR2032 battery (included)
- Ocular and Objective Flip-Up Lens Covers

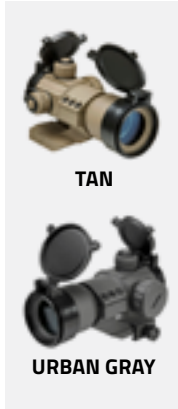

SPECIFICATIONS	DRGB135	DRGB135T	DRGB135U	VDBSOL130	VDBSOLC
MAGNIFICATION	1X	1X	1X	1X	1X
OBJECTIVE LENS DIAMETER	35 mm	35 mm	35 mm	27 mm	24.5 mm
DOT SIZE	3 MOA	3 MOA	3 MOA	2 MOA	4 MOA
WEIGHT (oz.)	9.1 oz	9.1 oz	9.1 oz	11.2 oz	9.4 oz
OVERALL LENGTH (in)	5.0"	5.0"	5.0"	4.0"	3.6"
CLICK VALUE @ 100 YDS	1 MOA	1 MOA	1 MOA	1/2 MOA	1/2 MOA
ILLUMINATION	Red/ Green / Blue	Red/ Green / Blue	Red/ Green / Blue	Red	Red
LENS COATING	Platinum	Platinum	Platinum	Ruby	Ruby
DIMENSIONS	5.0"L x 3.0"H x 2.7"D			4.0"L x 3.0"H x 2.2"D	3.6"L x 9.4"H x 2.3"D



RED DOT OPTICS WITH GREEN LASER & FLASHLIGHT

MODEL# VDFLGQ142

US PATENT: D704297

- LED 100% safe for the eyes
- 7 brightness settings for red illumination
- Fully adjustable green laser: freq. 532nm, Class IIIa laser, maximum output: <5mw
- Integrated flashlight (110 Lumen) with On/Off switch
- Fully adjustable green laser sight (elevation & windage) with On/Off switch
- Locking quick release mount
- Attaches to virtually any Weaver/Picatinny/MIL-STD 1913 rails

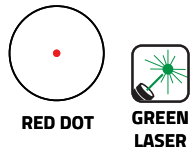

RED DOT OPTIC WITH RED LASER

MODEL# DLB140R

- LED 100% safe for the eyes
- 7 brightness settings for red illumination
- Fully adjustable red laser: freq. 635-655nm, Class IIIa laser, maximum output: <5mw
- Fully adjustable red laser sight (elevation & windage)
- Locking quick release mount
- Attaches to virtually any Weaver/Picatinny/MIL-STD 1913 rails

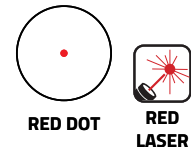

RED DOT REFLEX W/ INTEGRATED RED LASER
MODEL# DLB140R
▪ DETAILS ON THIS PAGE

AR15 TRI-RAIL MOUNT/ RISER FOR FLAT-TOP
MODEL# MTRIF
▪ DETAILS ON PAGE 37



AR15 COMBO RED DOT OPTIC, INTEGRATED RED LASER, FLASHLIGHT, AND MOUNT

MODEL#KARDLFS-A

- The Tri-Rail mount riser will bring the 40mm red dot reflex optic to a comfortable height, with two adjustable side rails for mounting accessories like the included 160 lumens LED flashlight.
- The 40mm red dot reflex optic allows the shooter to engage close range targets quickly and makes it easier to engage moving targets.
- The integrated red laser can be used to independently aim your rifle at a target in low light conditions.
- The bright LED flashlight helps with seeing where you are going and helps with illuminating and identifying your target

3W 160 LUMENS LED FLASHLIGHT
MODEL# ATFLB
▪ DETAILS ON PAGE 65

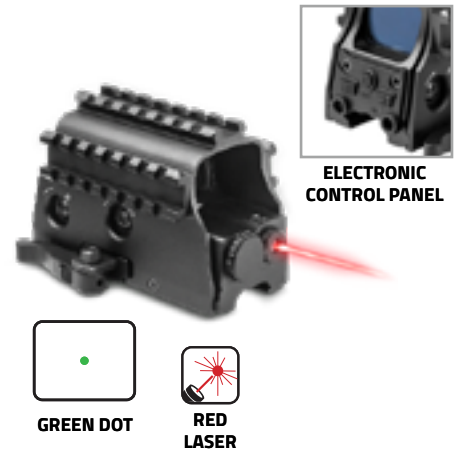

ELECTRONIC CONTROL PANEL

DESIGNED IN USA

TRI-RAIL GREEN DOT WITH RED LASER

MODEL# D3ARSQQLR2

US PATENT: D720034

- LED 100% safe for the eyes
- 5 brightness settings for green dot
- Fully adjustable red laser: freq. 635-655nm, Class IIIa laser, maximum Output: <5mw
- Fully adjustable red laser sight (elevation & windage)
- 3 rails (side & top) for mounting accessories
- Locking quick release mount
- Attaches to virtually any Weaver/Picatinny/MIL-STD 1913 rails

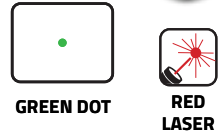

SPECIFICATIONS	D3ARSQQLR2	VDFLGQ142	DLB140R
MAGNIFICATION	1X	1X	1X
OBJECTIVE LENS DIAMETER	31 x 23 mm	42 mm	40 mm
DOT SIZE	2 MOA	3 MOA	3 MOA
WEIGHT (oz.)	14.6 oz	15.0 oz	11.0 oz
OVERALL LENGTH (in)	4.6"	4.5"	4.3"
CLICK VALUE @ 100 YDS	1 MOA	1 MOA	1 MOA
ILLUMINATION	Green	Red	Red
LENS COATING	Platinum	Ruby	Ruby
DIMENSIONS	4.6"L x 3.0"H x 2.8"D	4.5"L x 3.2"H x 3.3"D	4.3"L x 3.0"H x 3.5"D

DUAL TARGETING



Also available in
Tan
VDGRLT

DESIGNED IN USA

MICRO GREEN DOT WITH INTEGRATED RED LASER

BLACK - MODEL# VDGRBLB

TAN - MODEL# VDGRLT

US PATENT: D679775

- LED 100% safe for the eyes
- Unlimited eye relief
- Fully adjustable green dot and red laser
- 5 brightness settings for the green dot
- Fully adjustable Red Laser: Freq. 635-655nm, Class IIIa Laser, Maximum Output: <5mw
- A single rheostat to control green dot & red laser
- Powered by CR2032 lithium battery (included)
- Attaches to virtually any Weaver/Picatinny/ MIL-STD 1913 rails
- Includes lens covers

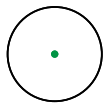

GREEN DOT



RED LASER



RHEOSTAT DIAL



DESIGNED IN USA

MICRO RED & BLUE DOT WITH GREEN LASER

MODEL# VDBRGLB

US PATENT: D765212

- LED 100% safe for the eyes
- Unlimited eye relief
- Fully adjustable red & blue dot green laser
- 5 brightness settings for the Red/Blue dot
- Fully adjustable Green Laser: Freq. 532nm, Class IIIa Laser, Maximum Output: <5mw
- Powered by CR123A lithium battery (included)
- Locking quick release mount
- Attaches to virtually any Weaver/Picatinny/ MIL-STD 1913 rails
- Includes lens covers

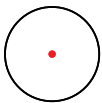

RED DOT

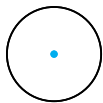

BLUE DOT



GREEN LASER



ELECTRONIC CONTROL PANEL



Also available in
without laser
VDBRB
See page 17

DESIGNED IN USA

UDS
URBAN DOT SIGHT



UDS - REFLEX OPTIC WITH GREEN LASER AND NAVIGATION LIGHTS

MODEL# VDSTNVRLGB

US PATENT: D747431 , 9316460

- LED 100% safe for the eyes
- Unlimited eye relief
- Fully integrated adjustable green laser
- 2 color navigation LED lights: white and red
- 5 brightness settings for the cross grid reticle
- Fully adjustable green laser: freq. 532nm Class IIIa laser, maximum output: <5mw
- Powered by one CR123A battery (included)
- Locking quick release mount
- Attaches to virtually any Weaver/ Picatinny/ MIL-STD 1913 type rails

CROSS GRID RETICLE

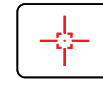

RED DOT



GREEN LASER



NAV LIGHTS



ELECTRONIC CONTROL PANEL

SPECIFICATIONS	VDGRBLB / VDGRLT	VDBRGLB	VDSTNVRLGB
MAGNIFICATION	1X	1X	1X
OBJECTIVE LENS DIAMETER	25 mm	25 mm	32 x 25 mm
DOT SIZE	3 MOA	3 MOA	-
WEIGHT	4.0 oz	6.4 oz	15.5oz
OVERALL LENGTH (in)	2.5"	2.6"	5.5"
CLICK VALUE @ 100 YDS	1 MOA	1 MOA	-
ILLUMINATION	Green	Red/Blue	Ruby
LENS COATING	Platinum	Platinum	Red
DIMENSIONS	2.5"L x 1.9"H x 1.7"D	2.6"L x 2.8"H x 1.9"D	5.5"L x 2.7"H x 2.4"D



DESIGNED IN USA

FLIPDOT FOR GLOCK® MOS PISTOLS

MODEL# VDFLIPGLOM2

US PATENT: US D846689 , US 9869526

- LED 100% safe for the eyes
- Unlimited eye relief
- Fits on the GLOCK® MOS pistols and slides that have been machined to accept RMR micro dot sights
- Flip up lens system deploys to the ON position with a push of a button
- Turn off the optic by simply folding the lens down until it locks into place
- Includes RMR base mount for GLOCK® rear sight dovetails
- Includes extra battery micro dot cover, and mounting/ adjustment Tools
- Black anodized aluminum

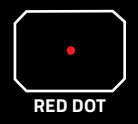

DESIGNED IN USA

FLIPDOT PRO

MODEL# VDFLIPPRO

US PATENT : US 9869526

- Fits on most slides that have been machined to accept RMR® micro dot sights.
- Mounts included for GLOCK® MOS models & for most GLOCK® double stack pistol models.
- Flip up lens system deploys to the ON position with a push of a lever
- Optic turns OFF when the optic is locked in the down position
- Powered by one CR2032 battery (included)
- Mounting and Adjustment tools included

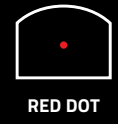
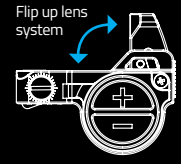
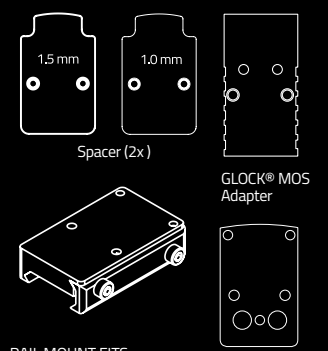
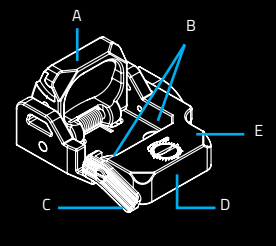

- RAIL MOUNT FITS:
- WEAVER/ PICATINNY/ MIL-STD 1913 TYPE RAILS

SPECIFICATIONS	VDFLIPGLOM2	VDFLIPPRO
MAGNIFICATION	1X	1X
OBJECTIVE LENS DIAMETER	22mm x 16mm	19.5mm x 13.2mm
DOT SIZE	3 MOA	3 MOA
WEIGHT	1.0 oz	1.5 oz
OVERALL LENGTH (in)	2.0"	1.8"
CLICK VALUE @ 100 YDS	1/2 MOA	2 MOA
ILLUMINATION	Red	Red
LENS COATING	Ruby	Ruby
DIMENSIONS	2.0"L x 1.2"H x 1.1"D	1.8"L x 1.2"H x 1.6"W

"GLOCK ®" is a federally registered trademark of and owned by Glock, Inc. or Glock Ges.m.b.H. NcSTAR Inc. is not affiliated with, or endorsed by Glock, Inc. or Glock Ges.m.b.H.

RMR® is a trademark of Trijicon®, Inc

MICRO DOT

DESIGNED IN USA

KQR MICRO REFLEX SIGHT

MODEL# VDDABKM

US PATENT: 9341441



- LED 100% safe for the eyes
- Unlimited eye relief
- KeyMod™ quick release latch system locks the reflex sight tightly to any KeyMod™ spec handguard
- Side armor protect the micro dot from potential damage
- Skeletonized design to reduce weight
- Includes extra battery, micro dot cover, and mounting/ adjustment tools
- Black anodized aluminum



QUICK RELEASE LATCH SYSTEM

Lightweight riser mount is the perfect height over bore for accurate zeroing at 90 degree or 45 degree setting



Switch Type:
Standard On/Off

RED DOT



MICRO RED DOT REFLEX OPTIC

MODEL# DDAB

- Red dot LED 100% safe for the eyes
- Unlimited eye relief
- Mounting base fits virtually any Weaver/ Picatinny type rails
- Includes extra battery, micro dot cover, and mounting/ adjustment tools
- Black anodized aluminum

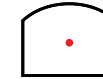

Switch Type:
Standard On/Off

RED DOT



MICRO GREEN DOT REFLEX OPTIC

MODEL# DDABG

- Green dot LED 100% safe for the eyes
- Unlimited eye relief
- Mounting base fits virtually any Weaver/ Picatinny type rails
- Includes extra battery, micro dot cover, and mounting/ adjustment tools
- Black anodized aluminum

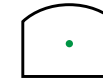

Switch Type:
Standard On/Off

GREEN DOT



MICRO BLUE DOT REFLEX OPTIC

MODEL# DDABL

- Blue dot LED 100% safe for the eyes
- Unlimited eye relief
- Mounting base fits virtually any Weaver/ Picatinny type rails
- Includes extra battery, micro dot cover, and mounting/ adjustment tools
- Black anodized aluminum

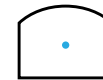

Switch Type:
Standard On/Off

BLUE DOT

SPECIFICATIONS	DDAB	DDABG	DDABL	VDDABKM
MAGNIFICATION	1x	1X	1X	1X
OBJECTIVE LENS DIAMETER	23.5 x 16.8 mm	23.5 x 16.8 mm	23.5 x 16.8 mm	23.5 x 16.8 mm
DOT SIZE	2 MOA	2 MOA	2 MOA	2 MOA
WEIGHT (oz.)	1.7 oz.	1.7 oz.	1.7 oz.	3.5 oz.
OVERALL LENGTH (in)	1.9"	1.9"	1.9"	2.7"
CLICK VALUE @ 100 YDS	1 MOA	1 MOA	1 MOA	1 MOA
ILLUMINATION	Red	Green	Blue	Red
LENS COATING	Ruby	Platinum	Platinum	Ruby
DIMENSIONS	1.9"L x 1.4"H x 1.2"D	1.9"L x 1.4"H x 1.2"D	1.9"L x 1.4"H x 1.2"D	2.7"L x 2.4"H x 1.4"D

LARGE TUBE & MAGNIFIER

REFLEX OPTICS



RED DOT REFLEX OPTIC

MODEL# DBB142

- LED 100% safe for the eyes
- Unlimited eye relief
- Fully adjustable red dot (windage & elevation)
- 7 brightness settings
- 42mm Objective lens
- Integrated Weaver style mount
- See-through flip-up lens covers included
- Powered by CR2032 battery included

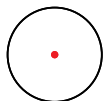

RED DOT



RED DOT REFLEX OPTIC

MODEL# DBB130

- LED 100% safe for the eyes
- Unlimited eye relief
- Fully adjustable red dot (windage & elevation)
- 7 brightness settings
- 30mm Objective lens
- Integrated Weaver style mount
- See-through flip-up lens covers included
- Powered by CR2032 battery included

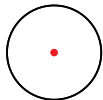

RED DOT

SPECIFICATIONS	DBB142	DBB130
MAGNIFICATION	1X	1x
OBJECTIVE LENS DIAMETER	42 mm	30 mm
DOT SIZE	3 MOA	3 MOA
WEIGHT (oz.)	7.4 oz.	7.5 oz.
OVERALL LENGTH (in)	4.3"	4.5"
CLICK VALUE @ 100 YDS	1 MOA	1 MOA
ILLUMINATION	Red	Red
LENS COATING	Ruby	Ruby
DIMENSIONS	4.3"L x 2.5"H x 1.8"D	4.5"L x 2.5"H x 1.8"D



DESIGNED IN USA

3X MAGNIFIER WITH FLIP-TO-SIDE QR MOUNT

MODEL# SMAG3XFLP

- Magnifier center line at 1.5" AR15 Height
- Elevation & windage adjustments to center the reflex optics reticle in the center of the magnifier
- Push button for flip-to-side
- Quick focus eyepiece
- Locking quick release mount
- Attaches to virtually any Weaver/Picatinny/ MIL-STD 1913 type rails

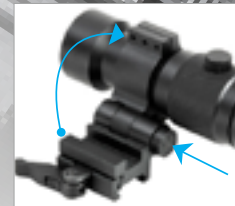

SPECIFICATIONS	SMAG3XFLP
MAGNIFICATION	3X
OBJECTIVE LENS DIAMETER	35 mm
DOT SIZE	-
WEIGHT (oz.)	6.4 oz.
OVERALL LENGTH (in)	4.6"
CLICK VALUE @ 100 YDS	-
ILLUMINATION	-
LENS COATING	Green
DIMENSIONS	4.6"L x 3.6"H x 2.4"D

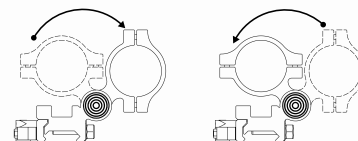

Magnifier can be flipped to the side by depressing a spring loaded button and flipping top half of mount and magnifier to the side. Mount locks into either down or side positions.

STR SERIES



**1-6X24
FULL SIZE SCOPE**

LPV - MODEL# SEEFL1624G

- Fully multi-coated lens
- Target turrets with turret caps.
- Quick focus eyepiece
- 5 brightness setting for red/green illumination
- Powered by CR2032 lithium battery (included)
- Lens cover (included)
- One piece 30 mm scope body.

GLASS ETCHED
LPV

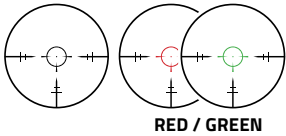

RED / GREEN



**4-16X44
FULL SIZE SCOPE**

P4 SNIPER - MODEL# SEEF41644G

- Adjustable parallax knob
- Fully multi-coated lens
- Target turrets with turret caps.
- Quick focus eyepiece
- 5 brightness setting for red/green illumination
- Powered by CR2032 lithium battery (included)
- Lens cover (included)
- One piece 30 mm scope body.

GLASS ETCHED
P4 SNIPER

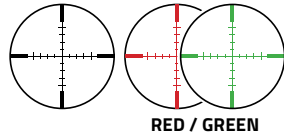

RED / GREEN



**3-9X40
FULL SIZE SCOPE**

P4 SNIPER - MODEL# SEEFB3940G

- Fully multi-coated lens
- Quick focus eyepiece
- 5 brightness setting for red/green illumination
- Powered by CR2032 lithium battery (included)
- Lens cover (included)
- Aluminum Weaver style rings (included)

P4 SNIPER

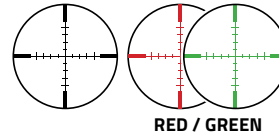

RED / GREEN



**3-9X40
FULL SIZE SCOPE**
NON-ILLUMINATED

P4 SNIPER - MODEL# SFB3940G

- Variable power magnification
- Multi-coated lens
- Airgun reverse recoil compatible
- Lens cover (included)
- Aluminum Weaver style rings (included)

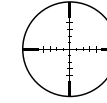

P4 SNIPER
Non-Illuminated

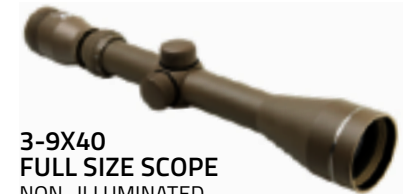

**3-9X40
FULL SIZE SCOPE**
NON-ILLUMINATED

PLEX - MODEL# SFB3940BT

- Multi-coated lens
- Quick focus eyepiece
- Airgun reverse recoil compatible
- Includes lens cover
- Tan scope rings
- Powder coated tan

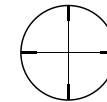

PLEX
Non-Illuminated

SPECIFICATIONS	SEEFL1624G	SEEF41644G	SEEFB3940G	SFB3940G	SFB3940BT
MAGNIFICATION	1X - 6X	4X - 16X	3X -9X	3X -9X	3X -9X
TUBE DIAMETER	30 mm	30 mm	1"	1"	1"
OBJECTIVE LENS DIAMETER	24 mm	44 mm	40 mm	40 mm	40 mm
FIELD OF VIEW (ft @ 100 yds)	106.3 ft - 17.3 ft	26.2 ft - 6.8 ft	36.6 ft - 16.6 ft	36.6 ft - 16.6 ft	36.6 ft - 16.6 ft
EYE RELIEF	3.8" - 3.8"	3.7" - 3.3"	2.8" - 3.3"	2.8" - 3.3"	2.8" - 3.3"
WEIGHT (oz.)	15.5 oz.	23.0 oz.	18.4 oz.	16.1 oz.	16.1 oz.
OVERALL LENGTH (in)	9.6"	13.2"	12.3"	12.2"	12.2"
EXIT PUPIL	13.3-4.4 mm	11.0-2.75 mm	13.3-4.4 mm	13.3-4.4 mm	13.3-4.4 mm
CLICK VALUE @ 100 YDS	1/2 MOA	1/4 MOA	1/4 MOA	1/4 MOA	1/4 MOA
ILLUMINATION	Red / Green	Red / Green	Red / Green	N/A	N/A
LENS COATING	Green	Green	Green	Green	Blue
DIMENSIONS	13.2"L x 2.7"H x 2.4"D	13.2"L x 2.7"H x 2.4"D	12.2"L x 1.8"H x 2.6"D	12.2"L x 1.9"H x 2.6"D	12.2"L x 1.9"H x 2.6"D



**4-16X44
FULL SIZE SCOPE WITH SPR MOUNT**

P4 SNIPER - MODEL# SEEFP41644GSPR-A

- 5 brightness setting for red/green illumination
- Adjustable parallax knob
- Fully multi-coated lens
- Target turrets with turret caps.
- Quick focus eyepiece
- Powered by CR2032 lithium battery (included)
- Lens cover (included)
- One piece 30 mm scope body.
- Attaches to virtually any Weaver/Picatinny/MIL-STD 1913 type rails
- Aluminum body with black anodized finish

GLASS ETCHED
P4 SNIPER

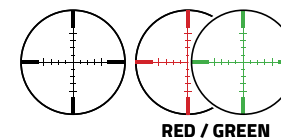

RED / GREEN



SPR MOUNT
MODEL#VMSPRBV2
See page 52

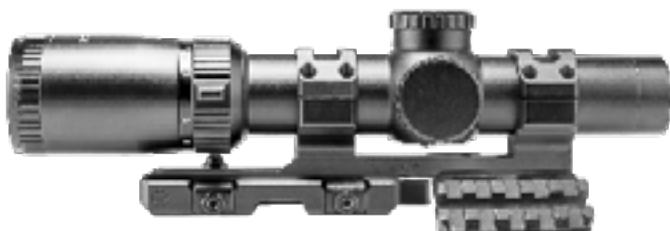

**1-6X24
FULL SIZE SCOPE WITH SPR MOUNT**

LPV - MODEL# SEEFL1624GSPR-A

- 5 brightness setting for red/green illumination
- Fully multi-coated lens
- Target turrets with turret caps.
- Quick focus eyepiece
- Powered by CR2032 lithium battery (included)
- Lens cover (included)
- One piece 30 mm scope body.
- Attaches to virtually any Weaver/Picatinny/MIL-STD 1913 type rails
- Aluminum body with black anodized finish

GLASS ETCHED
LPV

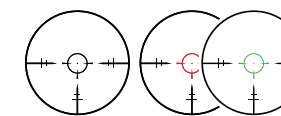

RED / GREEN



SPR MOUNT
MODEL#VMSPRBV2
See page 52

30mm CANTILEVERED

SFA
SCOPE MOUNT
COMBOS

SPECIFICATIONS	SEEFL1624GSPR-A	SEEFP41644GSPR-A
MAGNIFICATION	1X - 6X	4X - 16X
TUBE DIAMETER	30 mm	30 mm
OBJECTIVE LENS DIAMETER	24 mm	44 mm
FIELD OF VIEW (ft @ 100 yds)	106.3 ft - 17.3 ft	26.2 ft - 6.8 ft
EYE RELIEF	3.8" - 3.8"	3.7" - 3.3"
EXIT PUPIL	13.3 - 4.4 mm	11.0 - 2.75 mm
WEIGHT (oz.)	15.5 oz.	31.8 oz.
OVERALL LENGTH (in)	9.6"	13.2"
CLICK VALUE @ 100 YDS	1/2 MOA	1/4 MOA
ILLUMINATION	Red / Green	Red / Green
LENS COATING	Green	Green
DIMENSIONS	9.6"L x 2.7"H x 2.1"D	13.2"L x 2.7"H x 2.4"D

MARK III TACTICAL SERIES

DESIGNED IN USA

ULTIMATE SIGHTING SYSTEM

GENERATION III

3-9X40 SCOPE WITH MICRO DOT

BLACK

MIL-DOT W/ RED MICRO DOT - VSTM3940GDV3

P4 SNIPER W/ RED MICRO DOT - VSTP3940GDV3

TAN

MIL-DOT W/ RED MICRO DOT - VSTM3940GDV3T

P4 SNIPER W/ RED MICRO DOT - VSTP3940GDV3T

US PATENT: D781990

- Includes Micro Red Dot optic and micro dot armored mount on top of the scope
- 5 brightness settings for the Red/Blue Illuminated reticle
- Quick focus eyepiece
- Powered by one AA battery (Scope) and CR2032 battery (micro dot) batteries included
- Aluminum body
- Locking quick release mount attaches to virtually any Weaver/ Picatinny/ MIL-STD 1913 type rails

MICRO RED DOT
REFLEX OPTIC
MODEL# DDAB
See page 22

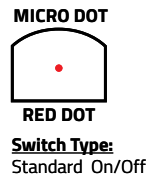
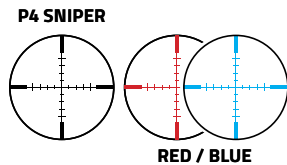
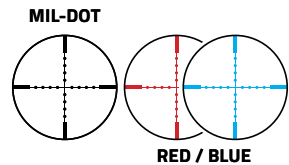

SPECIFICATIONS	SCOPE	MICRO DOT
MAGNIFICATION	3X - 9X	1X
OBJECTIVE LENS DIAMETER	40 mm	23.5 x 16.8 mm
FIELD OF VIEW (FT @ 100 YDS)	36.8'-12.0'	DOT SIZE: 2 MOA
EYE RELIEF	2.5"	N/A
EXIT PUPIL	13.4 - 4.4 mm	N/A
TOTAL WEIGHT (oz.)	22.4 oz.	
OVERALL LENGTH (in)	7.3"	
SCOPE CENTER LINE	1.5"	
CLICK VALUE @ 100 YDS	1/2 MOA	1 MOA
ILLUMINATION	Red/ Blue	Red
LENS COATING	Green	Ruby
DIMENSIONS	7.3"L x 4.0"H x 3.0"D	



ELECTRONIC CONTROL PANEL

Ⓢ Reticle Color Switch Button

⬇️ ⬆️ RETICLE BRIGHTNESS SETTINGS & ON/OFF Buttons

DESIGNED IN USA

MARK III
TACTICAL SERIES
GENERATION III

3-9X40 SCOPE

BLACK

P4 SNIPER - MODEL# VSTP3940GV3

MIL-DOT - MODEL# VSTM3940GV3

TAN

P4 SNIPER - MODEL# VSTP3940GV3T

MIL-DOT - MODEL# VSTM3940GV3T

US PATENT: D781990

- Quick focus eyepiece
- 5 brightness settings for the red/blue illuminated reticle
- Includes lens cover
- Powered by one AA battery
- Fully multi coated lenses
- Locking quick release mount
- Aluminum body
- Attaches to virtually any Weaver/Picatinny/ MIL-STD 1913 type rails
- Fog, water, and shock proof

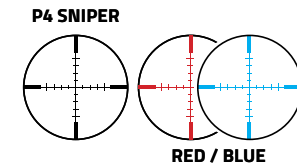
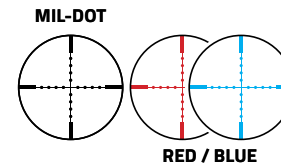

SPECIFICATIONS	SCOPE	MICRO DOT
MAGNIFICATION	3X - 9X	1X
OBJECTIVE LENS DIAMETER	40 mm	23.5 x 16.8 mm
FIELD OF VIEW (FT @ 100 YDS)	36.8'-12.0'	DOT SIZE: 2 MOA
EYE RELIEF	2.5"	N/A
EXIT PUPIL	13.3 - 4.4 mm	N/A
WEIGHT (oz.)	19.7 oz.	
OVERALL LENGTH (in)	7.3"	
SCOPE CENTER LINE	1.5"	
CLICK VALUE @ 100 YDS	1/2 MOA	1 MOA
ILLUMINATION	Red / Blue	Red
LENS COATING	Green	Ruby
DIMENSIONS	7.3"L x 2.0"H x 3.0"D	



ELECTRONIC CONTROL PANEL

Ⓢ Reticle Color Switch Button

⬇️ ⬆️ RETICLE BRIGHTNESS SETTINGS & ON/OFF Buttons

DESIGNED IN USA

MARK III
TACTICAL SERIES
GENERATION II



3-9X42 SCOPE

P4 SNIPER - MODEL# STP3942GV2

MIL-DOT - MODEL# STM3942GV2

US PATENT: D732633

- Quick focus eyepiece
- 3 brightness settings for the green/blue illuminated reticle
- Includes lens cover and batteries
- 100-500 yard Bullet Drop Compensator (BDC) calibrated for M193 55gr. FMJ Mil-Spec ammo
- Powered by one CR2032 battery
- Fully multi coated lenses
- Locking quick release mount
- Aluminum body with black anodized finish
- Attaches to virtually any Weaver/Picatinny/ MIL-STD 1913 type rails

MIL-DOT

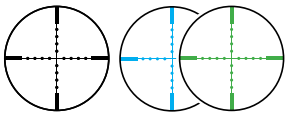

BLUE / GREEN

P4 SNIPER

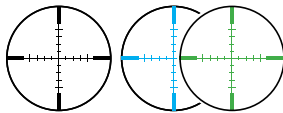

BLUE / GREEN

SPECIFICATIONS

MAGNIFICATION	3X - 9X
OBJECTIVE LENS DIAMETER	42 mm
FIELD OF VIEW (FT @ 100 YDS)	36.8'-12.0'
EYE RELIEF	2.0"
EXIT PUPIL	14.0 - 4.7 mm
WEIGHT (oz.)	17.3 oz.
OVERALL LENGTH (in)	7.5"
SCOPE CENTER LINE	1.5"
CLICK VALUE @ 100 YDS	1/2 MOA
ILLUMINATION	Blue / Green
LENS COATING	Green
DIMENSIONS	7.5"L x 2.0"H x 3.0"D

MARK III TACTICAL SERIES

DESIGNED IN USA

ULTIMATE
SIGHTING
SYSTEM
GENERATION II

3-9X42 SCOPE WITH MICRO DOT

P4 SNIPER + RED MICRO DOT - MODEL# STP3942GDV2

MIL-DOT + RED MICRO DOT - MODEL# STM3942GDV2

US PATENT: D732633

- Micro Dot and Micro Dot scope base mount Included
- 3 brightness setting for the Blue/ Green Illuminated reticle
- 100-500 yard Bullet Drop Compensator (BDC) calibrated for M193 55gr. FMJ Mil-Spec ammo
- Locking quick release mount
- Attaches to virtually any Weaver/Picatinny/ Mil-STD 1913 type rails
- Quick focus eyepiece
- Powered by one CR2032 battery (Scope) and CR2032 battery (Micro Dot) batteries included
- Aluminum body with black anodized finish

MIL-DOT

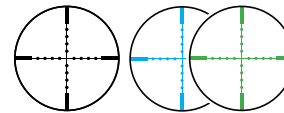

BLUE / GREEN

P4 SNIPER

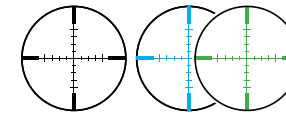

BLUE / GREEN

MICRO DOT



RED DOT

Switch Type:
Standard On/Off

SPECIFICATIONS

	SCOPE	MICRO DOT
MAGNIFICATION	3X - 9X	1X
OBJECTIVE LENS DIAMETER	42 mm	23.5 x 16.8 mm
FIELD OF VIEW (FT @ 100 YDS)	36.8'-12.0'	DOT SIZE: 2 MOA
EYE RELIEF	2.0"	N/A
EXIT PUPIL	14.0 - 4.7 mm	N/A
TOTAL WEIGHT (oz.)	19.6 oz.	
OVERALL LENGTH	7.5"	
SCOPE CENTER LINE	1.5"	
CLICK VALUE @ 100 YDS	1/2 MOA	1 MOA
ILLUMINATION	Blue / Green	Red
LENS COATING	Green	Ruby
DIMENSIONS	7.5"L x 3.6"H x 3.0"D	

MICRO RED DOT
REFLEX OPTIC
MODEL# DDAB
See page 22

SCOPES



DESIGNED IN USA

ADO SERIES
ADO
ADVANCED DUAL OPTICS

P4 SNIPER RETICLE
FLIP-UP REFLEX RED DOT OPTIC

BLACK P4 SNIPER - MODEL# VADOBP3942G
TAN P4 SNIPER - MODEL# VADOTP3942G

US PATENT: 9163902
US PATENT: D803347

- Integrated flip up reflex optic on top of the scope body
- Quick focus eyepiece
- 5 brightness settings for the red/blue
- Multi coated lenses
- Black anodized aluminum
- Lens covers (included)
- Powered by one CR123A lithium battery (included)
- Locking quick release mount
- Attaches to virtually any Weaver/ Picatinny/ MIL-STD 1913 type rails
- Fog, water, and shock proof



OCULAR BODY

ADO's whole ocular body functions as a large magnification ring. There is also an adjustable reticle focus ring at the end of the ocular lens.

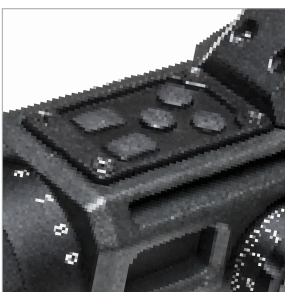

ELECTRONIC CONTROL PANEL

C Reticle Color Selector

+ Red Dot Brightness Setting Buttons

-

RETICLE BRIGHTNESS

TURN ON: Hold (+) Button

TURN OFF: Press both (+) & (-) Button



FLIP- UP REFLEX

Push button release automatically deploys front lens.

Quick flip red dot reflex optic with Auto ON/OFF. Turns on automatically when lens is deployed



Also available:

TAN - MODEL# VADOTP3942G

SPECIFICATIONS	SCOPE	MICRO DOT
MAGNIFICATION	3X - 9X	1X
OBJECTIVE LENS DIAMETER	42 mm	22 - 16 mm
FIELD OF VIEW (FT @ 100 YDS)	36.8' - 12.0'	DOT SIZE: 2 MOA
EYE RELIEF	2.5"	N/A
EXIT PUPIL	14.0 - 4.7mm	N/A
WEIGHT (oz.)	21.0 oz	
OVERALL LENGTH (in)	7.3 in	
CLICK VALUE @ 100 YDS	1/2 MOA	1 MOA
ILLUMINATION	Red/ Blue	Red Dot
LENS COATING	Green	Platinum
DIMENSIONS	7.8"L x 2.0"H x 3.9"D	

P4 SNIPER

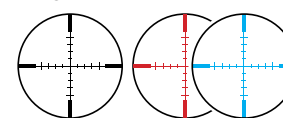

RED / BLUE



RED DOT

DESIGNED IN USA



4X34 ECO SCOPE WITH GREEN LASER AND LED NAVIGATION

BLACK - URBAN TACTICAL- MODEL# VECO434QRBM2
TAN - URBAN TACTICAL- MODEL# VECO434QRTM2

US PATENT: 9,316460
 US PATENT: D757886

- 2 color navigation LED lights: white, red
- 5 brightness settings for the blue illuminated reticle (scope)
- Fully adjustable green laser: Freq. 532nm, Class IIIa Laser, maximum Output: <5mw
- Fully multi coated lenses
- Locking quick release mount
- Aluminum body
- Includes lens covers
- Powered by one CR123A battery (included)
- Attaches to virtually any Weaver/Picatinny/ MIL-STD 1913 type rails
- Fog, water, and shock proof

GLASS ETCHED URBAN TACTICAL

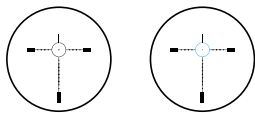

BLUE



ELECTRONIC CONTROL PANEL

- Green Laser ON/OFF
- NAV. light color switch & ON/OFF
- Reticle Brightness Settings & ON/OFF

SPECIFICATIONS	VECO434QRBM2 VECO434QRTM2
MAGNIFICATION	4X
OBJECTIVE LENS DIAMETER	34 mm
FIELD OF VIEW (ft @ 100 yds)	29.2'
EYE RELIEF	2.3"
EXIT PUPIL	8.5 mm
WEIGHT (oz.)	19.9 oz.
OVERALL LENGTH (in)	6.3"
SCOPE CENTER LINE	1.5"
CLICK VALUE @ 100 YDS	1/4 MOA
ILLUMINATION	Blue
LENS COATING	Green
DIMENSIONS	6.3"L x 2.5"H x 2.5"D

MICRO RED DOT REFLEX OPTIC
 MODEL# DDAB
 See page 22



4X34 ECO SCOPE WITH RED MICRO DOT

BLACK - MODEL# VECO434QRBR-A
TAN - MODEL# VECO434QRTR-A

US PATENT: 9316460
 US PATENT: D757886

- Integrated base on top of scope is designed for NcSTAR® micro dots (micro dot included)
- 5 brightness setting for the Blue Illuminated reticle
- Locking quick release mount
- Attaches to virtually any Weaver/Picatinny/ MIL-STD 1913 type rails
- Powered by one CR123A battery (Scope) and CR2032 battery (Micro Dot) batteries included
- Aluminum body

GLASS ETCHED URBAN TACTICAL

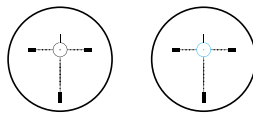

BLUE

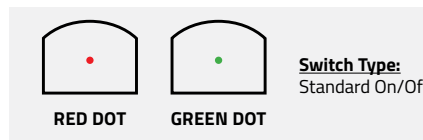

Switch Type:
Standard On/Off

SPECIFICATIONS	VECO434QRBR-A VECO434QRTR-A	VECO434QRBG-A VECO434QRTG-A	DDAB	DDABG
MAGNIFICATION	4X	4X	1X	1X
OBJECTIVE LENS DIAMETER	34 mm	34 mm	23.5X16.8 mm	23.5X16.8 mm
FIELD OF VIEW (ft @ 100 yds)	29.2'	29.2'	DOT SIZE: 2 MOA	DOT SIZE: 2 MOA
EYE RELIEF	2.3"	2.3"	N/A	N/A
EXIT PUPIL	8.5 mm	8.5 mm	N/A	N/A
WEIGHT (oz.)	21.0 oz.			
OVERALL LENGTH (in)	6.3"			
SCOPE CENTER LINE	1.5"			
CLICK VALUE @ 100 YDS	1/4 MOA	1/4 MOA	1 MOA	1 MOA
ILLUMINATION	Blue	Blue	Red	Green
LENS COATING	Green	Green	Ruby	Platinum
DIMENSIONS	6.3"L x 3.0"H x 2.5"D			

ECO SERIES

MICRO GREEN DOT REFLEX OPTIC
 MODEL# DDABG
 See page 22



4X34 ECO SCOPE WITH GREEN MICRO DOT

BLACK - MODEL# VECO434QRBG-A
TAN - MODEL# VECO434QRTG-A

US PATENT: 9316460
 US PATENT: D757886

SCOPES

CPO SCOPES



3.5X32MM COMPACT PRISMATIC OPTIC

URBAN TACTICAL- MODEL# SEECPRQ3532G

US PATENT: D774158

- High definition prismatic lens
- Quick focus eyepiece
- 5 brightness settings for the green/ blue illuminated reticle
- Includes lens cover
- Fully multi coated lenses
- Locking quick release mount
- Convertible QR mount is also AR carry handle compatible mount.
- Attaches to virtually any Weaver/ Picatinny/ MIL-STD 1913 type rails
- Fog, water, and shock proof
- Aluminum body with black anodized finish

GLASS ETCHED
URBAN TACTICAL

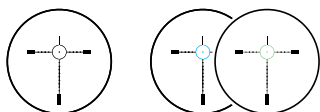

BLUE / GREEN

SPECIFICATIONS	SEECPRQ3532G
MAGNIFICATION	3.5X
OBJECTIVE LENS DIAMETER	32 mm
FIELD OF VIEW (ft @ 100 yds)	31.5'
EYE RELIEF	2.0"
EXIT PUPIL	8.9 mm
WEIGHT (oz.)	12.5 oz.
OVERALL LENGTH (in)	5.3"
SCOPE CENTER LINE	1.5"
CLICK VALUE @ 100 YDS	1/4 MOA
ILLUMINATION	Blue/ Green
LENS COATING	Green
DIMENSIONS	5.3"L x 3.0"H x 2.6"D



RED MICRO DOT
REFLEX OPTIC
MODEL# DDAB
See page 22



3.5X32MM CPO SCOPE WITH RED MICRO DOT

URBAN TACTICAL- MODEL# SEECPRQ3532GD-A

US PATENT: D774,158

- Integrated base on top of scope is designed for NcSTAR® Micro Dots (micro dot Included)
- 5 brightness settings for the green/blue illuminated reticle
- Locking quick release mount
- Scope mount can also be mounted to AR Carry Handles
- Attaches to virtually any Weaver/Picatinny/Mil-STD 1913 type rails
- Quick focus eyepiece
- Powered by one CR2032 battery (Scope) and CR2032 battery (Micro Dot) batteries included
- Aluminum body with black anodized finish

GLASS ETCHED
URBAN TACTICAL

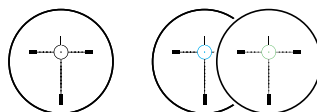

BLUE / GREEN

SPECIFICATIONS	SEECPRQ3532GD-A	SEECPRQ3532GG-A	DDAB	DDABG
MAGNIFICATION	3.5X	3X -9X	1X	1X
OBJECTIVE LENS DIAMETER	32 mm	30 mm	23.5X16.8 mm	23.5X16.8 mm
FIELD OF VIEW (ft @ 100 yds)	31.5'	42 mm	DOT SIZE: 2 MOA	DOT SIZE: 2 MOA
EYE RELIEF	2.0"	2.0"	N/A	N/A
EXIT PUPIL	8.9 mm	8.9 mm	N/A	N/A
WEIGHT (oz.)	13.4 oz.			
OVERALL LENGTH (in)	5.3"			
SCOPE CENTER LINE	1.5"			
CLICK VALUE @ 100 YDS	1/4 MOA	1/4 MOA	1 MOA	1 MOA
ILLUMINATION	Blue/ Green	Blue/ Green	Red	Green
LENS COATING	Green	Green	Ruby	Platinum
DIMENSIONS	5.3"L x 3.8"H x 2.6"D	5.3"L x 3.8"H x 2.6"D	1.9"L x 1.4"H x 1.2"D	1.9"L x 1.4"H x 1.2"



GREEN MICRO DOT
REFLEX OPTIC
MODEL# DDABG
See page 22



3.5X32MM CPO SCOPE WITH GREEN MICRO DOT

URBAN TACTICAL- MODEL# SEECPRQ3532GG-A

US PATENT: D774,158

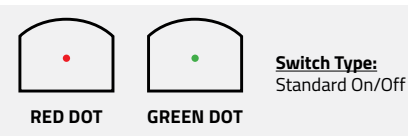

Switch Type:
Standard On/Off

RED DOT GREEN DOT

COMPACT TACTICAL SERIES & LONG EYE RELIEF

COMPACT TACTICAL SERIES



PLEX

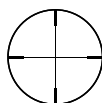

Non-illuminated

4X20 COMPACT SCOPE

PLEX
MODEL# SCA420B

- Fixed power magnification
- Multi-coated lens
- 3/8" dovetail rings (included)
- Lens covers (included)



P4 SNIPER

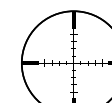

Non-illuminated

4X30 COMPACT SCOPE

P4 SNIPER
MODEL# SC430B

- One piece main tube
- Multi-coated lens
- Lens covers (included)

Scope rings not included



P4 SNIPER

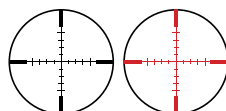

RED

3-9X42 COMPACT SCOPE

P4 SNIPER
MODEL# SEC3942R

- Red illuminated reticle
- 7 different levels of illumination brightness
- Variable power magnification
- Multi-coated lens
- Lens covers and extra battery (included)

Scope rings not included



P4 SNIPER

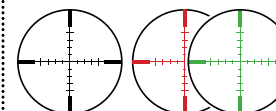

RED / GREEN

3-9X42 COMPACT RUBBER ARMORED SCOPE

P4 SNIPER
MODEL# SEECR3942R

- One piece aluminum main tube with rubber outer coating
- Reticles illuminate in red and green with multiple brightness settings
- Multi-coated lens
- Lens covers and extra battery (included)

SPECIFICATIONS	SCA420B	SC430B	SEC3942R	SEECR3942R
MAGNIFICATION	4X	4X	3X - 9X	3X - 9X
TUBE DIAMETER	.75"	1"	1"	30 mm
OBJECTIVE LENS DIAMETER	20 mm	30 mm	42 mm	42 mm
FIELD OF VIEW (ft @ 100 yds)	26.2 ft	26.2 ft	37.7 ft - 12.5 ft	37.7 ft - 12.5 ft
EYE RELIEF	2.5"	3.0"	3.0"	3.0"
EXIT PUPIL	5.0 mm	7.5 mm	14.0 - 4.7 mm	14.0 - 4.7 mm
WEIGHT (oz.)	3.1 oz.	9.2 oz.	12.1 oz.	13.4 oz.
OVERALL LENGTH (in)	7.88"	8.7"	7.5"	7.7"
CLICK VALUE @ 100 YDS	1/2 MOA	1/4 MOA	1/2 MOA	1/2 MOA
ILLUMINATION	N/A	N/A	Red	Red / Green
LENS COATING	Blue	Blue	Ruby	Ruby
DIMENSIONS	7.88"L x 1.2"H x 1.6"D	7.4"L x 1.8"H x 1.8"D	7.3"L x 2.8"H x 2.2"D	7.7"L x 3.3"H x 2.6"D

LONG EYE RELIEF



2.5X30 LONG EYE RELIEF

PLEX - SPB2530B

- Long eye relief for extended mounting capability
- Multi-coated lenses
- Fixed power magnification
- Non-illuminated reticle
- Includes 1" aluminum Weaver style rings, and lens covers

PLEX

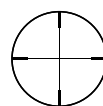

Non-illuminated



2-7X32 LONG EYE RELIEF

PLEX - SPB2732B

- Long eye relief for extended mounting capability
- Multi-coating lenses
- Variable power magnification
- Non-illuminated reticle
- Includes 1" aluminum Weaver style rings, and lens covers

PLEX

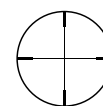

Non-illuminated



2-7X32 LONG EYE RELIEF

PLEX - SEP2732B

- Long eye relief for extended mounting capability
- Multi-coated lenses
- Variable power magnification
- Red illuminated reticle
- Includes 1" aluminum Weaver style rings, and lens covers

PLEX

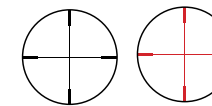

RED

SPECIFICATIONS	SPB2530B	SPB2732B	SEP2732B
MAGNIFICATION	2.5X	2X - 7X	2X - 7X
TUBE DIAMETER	1"	1"	1"
OBJECTIVE LENS DIAMETER	30 mm	32 mm	32 mm
FIELD OF VIEW (ft @ 100 yds)	19.0 ft	14.0 - 4.5 ft	14.0 - 4.5 ft
EYE RELIEF	10.4"	8.7 - 10.7"	8.7 - 10.7"
EXIT PUPIL	12.0 mm	16.0 - 4.6 mm	16.0 - 4.6 mm
WEIGHT (oz.)	11.0 oz	11.8 oz	9.6 oz
OVERALL LENGTH (in)	8.9"	11.1"	11.0"
CLICK VALUE @ 100 YDS	1/2 MOA	1/4 MOA	1/4 MOA
ILLUMINATION	N/A	N/A	N/A
LENS COATING	Blue	Blue	Blue
DIMENSIONS	8.6"L x 2.1"H x 1.8"D	11.1"L x 1.6"H x 2.1"D	11.0"L x 2.1"H x 1.8"D

SRT SERIES & DELTA SERIES



1 BULLET DROP COMPENSATOR
Low Profile Elevation Turret with a Bullet Drop Compensator (BDC) calibrated for M193 55gr. FMJ MIL-SPEC ammo.

2 OCULAR BODY
The SRT's whole ocular body functions as a large magnification ring. There is also an adjustable reticle focus ring at the end of the ocular lens. Includes Integrated flip-up lens covers.

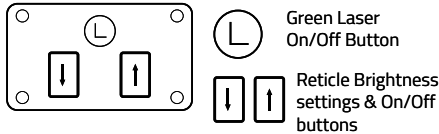

ELECTRONIC CONTROL PANEL

DESIGNED IN USA

SRT
SERIES
GENERATION III

3-9X40 SCOPE WITH INTEGRATED GREEN LASER

MIL-DOT - MODEL# VSRTM3940GV3
P4 SNIPER - MODEL# VS RTP3940GV3
US PATENT: D783116

- Integrated fully adjustable green laser
- Quick focus eyepiece
- 5 brightness settings for the red/blue illuminated reticle (Scope)
- Fully adjustable green laser: Freq. 532nm, Class IIa laser, maximum output: <5mw
- Fully multi coated lenses
- Locking quick release mount
- Black rubber armored aluminum body
- Integrated flip-up lens covers
- Powered by 2 AA batteries (included)
- Attaches to virtually any Weaver/ Picatinny/ MIL-STD 1913 type rails
- Fog, water, and shock proof

SPECIFICATIONS	SRT
MAGNIFICATION	3X - 9X
OBJECTIVE LENS DIAMETER	40 mm
FIELD OF VIEW (FT @ 100 YDS)	36.8' - 12.0'
EYE RELIEF	2.5"
EXIT PUPIL	13.3 - 4.4 mm
WEIGHT (oz.)	22.0 oz
OVERALL LENGTH (in)	8.4"
SCOPE CENTER LINE	1.5"
CLICK VALUE @ 100 YDS	1/2 MOA
ILLUMINATION	Red / Blue
LENS COATING	Green
DIMENSIONS	8.4"L x 2.3"H x 3.0"D

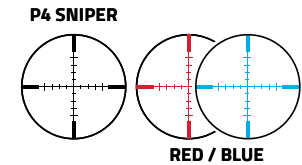
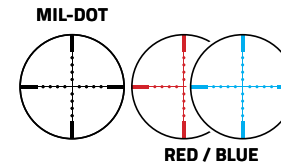

1 ELEVATION ADJUSTMENT
Elevation adjustment is done with the accessible turret wheel on the bottom of the scope and the windage adjustment is via the turret on the side

2 FULLY MULTI COATED LENSES
Fully multi-coated lens for a bright crystal clear image.

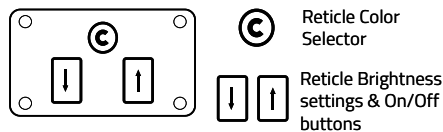

ELECTRONIC CONTROL PANEL

DESIGNED IN USA

DELTA
SCOPE

4X30 SCOPE WITH NAVIGATION LIGHTS

BLACK P4 SNIPER - MODEL# VDELP430G
TAN P4 SNIPER - MODEL# VDELTP430G
US PATENT: D814600

- Red & white LED NAV. lights on top of the scope body
- Quick focus eyepiece
- 5 brightness settings for the red/blue illuminated reticle (scope)
- Fully multi coated lenses
- Locking quick release mount
- Aluminum body with black anodized finish
- Includes lens covers
- Powered by 2 AA batteries (included)
- Attaches to virtually any Weaver/ Picatinny/ MIL-STD 1913 type rails
- Fog, water, and shock proof

SPECIFICATIONS	DELTA
MAGNIFICATION	4X
OBJECTIVE LENS DIAMETER	30 mm
FIELD OF VIEW (FT @ 100 YDS)	25.2'
EYE RELIEF	3.1"
EXIT PUPIL	7.5 mm
WEIGHT (oz.)	18.2 oz
OVERALL LENGTH (in)	6.7"
SCOPE CENTER LINE	1.5"
CLICK VALUE @ 100 YDS	1/2 MOA
ILLUMINATION	Red / Blue
LENS COATING	Green
DIMENSIONS	6.7"L x 2.2"H x 2.8"D

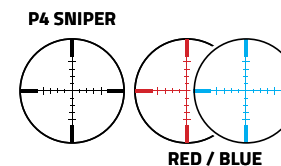



DESIGNED IN USA
XRS
SCOPE
2-7X32MM
ILLUMINATED SCOPE

MIL-DOT
MODEL# SECXRS2732G
US PATENT: D732631

- Quick focus eyepiece
- 7 brightness settings for the blue illuminated reticle
- Fully multi coated lenses
- Locking quick release mount
- Aluminum body with black anodized finish
- Convertible QR mount is also AR carry handle compatible mount.
- Attaches to virtually any Weaver/ Picatinny/ MIL-STD 1913 type rails
- Powered by one CR2032 battery (included)



Convertible QR mount is also AR carry handle compatible mount.



Large 34mm Scope Tube Diameter allows a bright clear image of your target

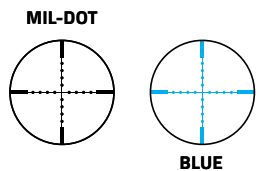

- INCLUDES 4 SEPARATE UPPER SCOPE RINGS:**
- 2 each Lightweight rings
 - Dual side rails accessory ring.
 - Low profile micro-dot reflex sight base.



DESIGNED IN USA
DUO
DUAL URBAN OPTIC
4X34MM WITH OFFSET
GREEN DOT

URBAN TACTICAL
MODEL# VDUO434DGB
LEFT HANDED
MODEL# VDUO434DGBLH
US PATENT: 9389046, D741446

- LED reticle 100% safe for eye
- Quick focus eyepiece
- 5 brightness settings for the both the blue reticle and green dot illumination
- Fully multi coated lenses
- Scope and reflex optic each have Independent zeroing adjustments
- Aluminum body with black anodized finish
- Lens covers (included)
- Powered by one 3-Volt lithium battery (included)
- 30° offset reflex green dot optic, maintain the same bore height as scope reticle
- Attaches to virtually any Weaver/Picatinny/ MIL-STD 1913 type rails
- Fog, water, and shock proof



Focus Ring
The DUO has an adjustable reticle focus ring at the end of the ocular lens.



Electronic Control Panel
Reticle and green dot optic: On/Off and brightness levels

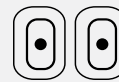

Left Button:
Reticle brightness settings and On/Off button
Right Button:
Dot brightness settings and On/Off button

GLASS ETCHED URBAN TACTICAL

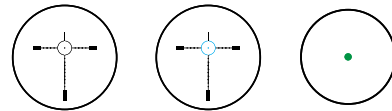

BLUE GREEN DOT



4X34mm - Left Hand:
MODEL: VDUO434DGBLH



DESIGNED IN USA
LIO
LIGHT INTEGRATED OPTIC
4 X 34MM WITH LED
NAVIGATION LIGHTS

URBAN TACTICAL
MODEL# VHLO434GB
US PATENT: 9291427, D750726

- Integrated navigation (red & white) LED lights with 4 modes
- Quick focus eyepiece
- Back-up iron sights
- 5 brightness settings for blue illuminated reticle
- Includes lens cover
- Fully multi coated lenses
- Locking quick release mount
- Aluminum body with black anodized finish
- Attaches to virtually any Weaver/ Picatinny/MIL-STD 1913 type rails
- Fog, water, and shock proof

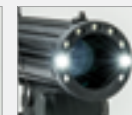

ELECTRONIC CONTROL PANEL
Blue reticle illumination and LED NAV light:
▪ On/Off
▪ LED light modes

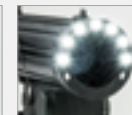
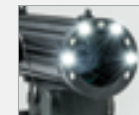

NAVIGATION LIGHT SETTING

- Integrated 2 color navigation LED lights in the objective housing:
- Red X 2
 - White X 7
 - 4 different selectable LED NAV light modes.



NAV. Light color switch & On/Off button



Reticle Brightness settings & On/Off buttons

GLASS ETCHED URBAN TACTICAL

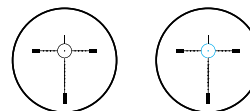

BLUE

SPECIFICATIONS	XRS	DUO	DUO MICRO DOT	LIO
MAGNIFICATION	2X-7X	4X	1X	4X
OBJECTIVE LENS DIAMETER	32 mm	34 mm	19 mm	34 mm
FIELD OF VIEW (FT @ 100 YDS)	38.3 - 12.7 ft	26.0'	DOT SIZE: 3 MOA	25.1'
EYE RELIEF	3.0"	2.5"	N/A	3.1"
EXIT PUPIL	6.0 - 4.6 mm	8.5 mm	N/A	8.5 mm
WEIGHT (oz.)	17.2 oz	16.0 oz		19.2 oz
OVERALL LENGTH (in)	7.1"	5.8"		6.8"
SCOPE CENTER LINE	1.5"	1.5"		1.5"
CLICK VALUE @ 100 YDS	1/2 MOA	1/2 MOA	1 MOA	1/2 MOA
ILLUMINATION	Blue	Blue	Green Dot	Blue
LENS COATING	Green	Green	Platinum	Green
DIMENSIONS	7.1"L x 2.0"H x 3.0"D	5.8"L x 3.4"H x 2.9"D		6.8"L x 3.4"H x 2.9"D

AR MOUNTS

DESIGNED IN USA

BLASTAR HANDGUARD CARBINE EXTENDED



14.0"



- The handguard fits onto ARs with carbine length handguards and gas tube. Mounts onto the barrel using the front handguard cap and the delta ring. The handguard wraps around the front sight post and extends forward of the front sight post for more handguard area for your support hand and accessories.
- The ergonomic carbine extended 2 piece triangular handguard features
- KeyMod™ mounting points.
- The top Picatinny rail of the handguard fits flush to mil-spec receivers providing a continuous rail.
- The handguard is skeletonized to reduce weight.
- Constructed of hard anodized aluminum.
- Mounting bolts and tools included.

14.0"	CARBINE EXTENDED LENGTH	MODEL# VKARHGE
-------	-------------------------	----------------

SPECIFICATIONS	
LENGTH	14.0"
NET WEIGHT	14.5 oz.
PATENT	US D855138

DESIGNED IN USA

TRIANGLE M-LOK® HANDGUARD



10.7"

8.9"



8.9"	CARBINE LENGTH	MODEL# VMARTMLC
14.4"	MID- LENGTH	MODEL# VMARTMLM

M-LOK® SLOT AT THE 2,6 & 10 O'CLOCK POSITIONS FOR MOUNTING RAIL SECTIONS AND ACCESSORIES.

INCLUDES:

- 2.4" **SHORT** (1.5 M-LOK®) M-LOK® Picatinny Accessory Rail
- 4.0" **MEDIUM** (2.5 M-LOK®) M-LOK® Picatinny Accessory Rail
- Receiver height top MIL-STD 1913 Picatinny rail.
- Black anodized aluminum construction.

DROP-IN INSTALLATION (Includes mounting bolts & tool)

SPECIFICATIONS	CARBINE	MID-LEGTH
LENGTH	8.9"	10.7"
NET WEIGHT	9.7 oz.	11.7 oz.
WEIGHT (+RAILS)	12.3 oz.	14.4 oz.
PATENT	US D779014	

DESIGNED IN USA

TRIANGLE KEYMOD™ HANDGUARD



10.8"

8.9"



8.9"	CARBINE LENGTH	MODEL# VMARTKMC
10.8"	MID- LENGTH	MODEL# VMARTKMM

KeyMod® SLOT AT THE 2,6 & 10 O'CLOCK POSITIONS FOR MOUNTING RAIL SECTIONS AND ACCESSORIES.

INCLUDES:

- 2.4" **SHORT** (3 KeyMod™) KeyMod™ Picatinny Accessory Rail
- 4.7" **MEDIUM** (5 KeyMod™) KeyMod™ Picatinny Accessory Rail
- Receiver height top MIL-STD 1913 Picatinny rail.
- Black anodized aluminum construction.

DROP-IN INSTALLATION (Includes mounting bolts & tool)

SPECIFICATIONS	CARBINE	MID-LEGTH
LENGTH	8.9"	10.8"
NET WEIGHT	9.5 oz.	11.4 oz.
WEIGHT (+RAILS)	11.9 oz.	13.9 oz.
PATENT	US D779014	

DESIGNED IN USA

M-LOK® HANDGUARD



7.5"	CARBINE LENGTH	MODEL# VMARMLC
9.5"	MID- LENGTH	MODEL# VMARMLM
13.5"	CARBINE EXTENDED LENGTH	MODEL# VMARMLCE
13.5"	CARBINE EXTENDED LENGTH (TAN)	MODEL# VMARMLCET

M-LOK® SLOT ON 7 OF 8 SIDES.

INCLUDES:

- **2.3" SHORT** (1.5 M-LOK®) M-LOK® Picatinny Accessory Rail
- **4.0" MEDIUM** (2.5 M-LOK®) M-LOK® Picatinny Accessory Rail
- Receiver height top MIL-STD 1913 Picatinny rail.
- Black anodized aluminum construction.

DROP-IN INSTALLATION (Includes mounting bolts & tools)

NOTE: Rear top Picatinny rail extends over the delta ring giving continuous rail platform across.

SPECIFICATIONS	CARBINE	MID-LENGH	CARBINE EXT.
LENGTH	7.5"	9.5"	13.5"
NET WEIGHT	6.3 oz.	7.9 oz.	10.5 oz.
WEIGHT (+RAILS)	8.9 oz.	10.5 oz.	13.0 oz.
PATENT	US D779013		PENDING

DESIGNED IN USA

KEYMOD™ HANDGUARD

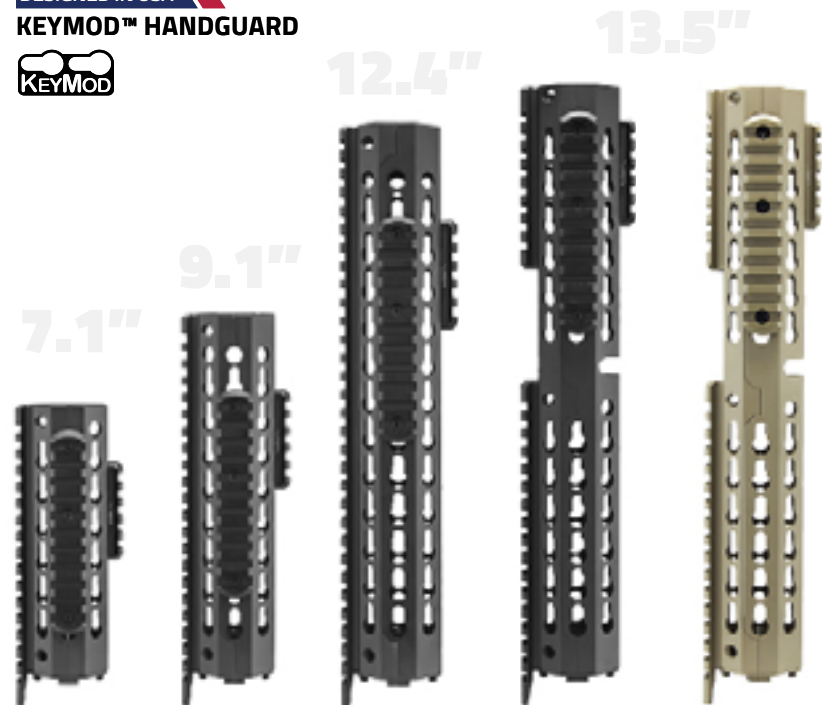

7.1"	CARBINE LENGTH	MODEL# VMARKMC
9.1"	MID- LENGTH	MODEL# VMARKMM
12.4"	RIFLE LENGTH	MODEL# VMARKMR
13.5"	CARBINE EXTENDED LENGTH	MODEL# VMARKMCE
13.5"	CARBINE EXTENDED LENGTH (TAN)	MODEL# VMARKMCET

KeyMod™ SLOTS ON 7 OF 8 SIDES.

INCLUDES:

- **2.4" SHORT** (3 KeyMod™) KeyMod™ Picatinny Accessory Rail
- **4.7" MEDIUM** (5 KeyMod™) KeyMod™ Picatinny Accessory Rail
- Receiver height top MIL-STD 1913 Picatinny rail.
- Black anodized aluminum construction.

DROP-IN INSTALLATION (Includes mounting bolts & tools)

NOTE: Rear top Picatinny rail extends over the delta ring giving continuous rail platform across.

SPECIFICATIONS	CARBINE	MID-LENGH	RIFLE LENGTH	CARBINE EXT.
LENGTH	7.1"	9.1"	12.4"	13.5"
NET WEIGHT	6.1 oz.	7.8 oz.	10.3 oz.	10.1 oz.
WEIGHT (+RAILS)	8.5 oz.	10.2 oz.	12.7 oz.	12.5 oz.
PATENT	US D737397	US D747426		US D736886

AR MOUNTS

DESIGNED IN USA

FREE FLOAT KEYMOD™ OCTAGON HANDGUARD



10"	10" LENGTH	MODEL# VMARFFKMC
13"	13" LENGTH	MODEL# VMARFFKMM
15"	15" LENGTH	MODEL# VMARFFKMR

KeyMod™ SLOTS ON 7 OF 8 SIDES.

INCLUDES:

- 2.4" **SHORT** (3 KeyMod™) KeyMod™ Picatinny Accessory Rail
- 4.7" **MEDIUM** (5 KeyMod™) KeyMod™ Picatinny Accessory Rail
- Receiver height top MIL-STD 1913 Picatinny rail.
- Black anodized aluminum construction.

NOTE: Requires low profile gas block.

SPECIFICATIONS	10" LENGTH	13" LENGTH	15" LENGTH
LENGTH	10.0"	13.0"	15.0"
NET WEIGHT	11.6 oz.	13.6 oz.	14.6 oz.
WEIGHT (+RAILS)	14.0 oz.	15.9 oz.	17.2 oz.
PATENT	US 9939228		



10"

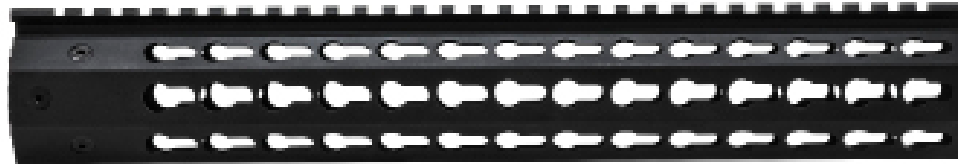

13"



15"

QUAD RAIL HANDGUARD GEN3



PICATINNY

6.7"	CARBINE LENGTH	MODEL# MAR4S
6.7"	CARBINE LENGTH (TAN)	MODEL# MAR4ST

QUAD RAIL GEN3 IS NARROWER & LIGHTER.

- Two piece quad rail handguard system.
- Picatinny/ MIL-STD 1913 spec rails.
- Manufactured from 6063 aluminum alloy, type II anodized.
- Large ventilation holes to dissipate heat.

DROP-IN INSTALLATION (Includes mounting bolts & tool)

SPECIFICATIONS	
LENGTH	6.7"
NET WEIGHT	9.9 oz.

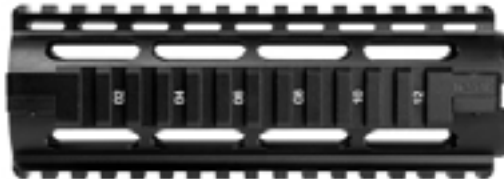

6.7"

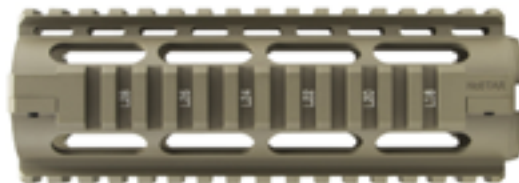

6.7"

AR MOUNTS



DESIGNED IN USA
AR15 CARRY HANDLE ADAPTER GEN 2

MODEL# MAR6M2

SPECIFICATIONS	
LENGTH	5.2"
NET WEIGHT	2.3 oz.

- Allows you to mount an optic onto the carry handle using Weaver/ Picatinny type rings & mounts.
- Attached to the Carry Handle via the supplied thumb nut. No tools required.
- See-through mount, when mounted onto the carry handle you can still utilize the Iron Sights.
- Black anodized aluminum construction.

3-9X42 COMPACT RUBBER ARMORED SCOPE
 MODEL# SEECR3942R
 See page 31



AR CARRY HANDLE 3X-9X COMPACT SCOPE COMBO

MODEL# KARHSEECR3942R-A

- NcSTAR's MAR6 Carry Handle Adapter and the 3-9X42 Compact Rubber Armored Scope with dual illumination (SEECR3942R). This will mount onto your AR15/M4 Carry Handle
- Combo includes: MAR6M2 + SEECR3942R

4 RETICLE REFLEX RED/ GREEN RETICLES
 MODEL# D4RGB
 See page 16



AR CARRY HANDLE & RED/GREEN 4 RET REFLES OPTIC

MODEL# KARHD4RGB-A

- This Combo includes NcSTAR's Carry Handle Adapter (MAR6M2) and the Red & Green four reticle reflex optic (D4RGB). This will mount onto your AR15/M4 Carry Handle
- Combo includes: MAR6M2 + D4RGB

RED DOT TUBE REFLEX OPTIC
 MODEL# DBB130
 See page 23



AR CARRY HANDLE & 30MM RED DOT OPTIC

MODEL# KARHDBB130-A

- 30mm Red Dot tube reflex optic
- Adapter Rail for the AR carry handle.
- Thumb nut. No tools required.
- See-through mount to utilize the iron sights
- Aluminum construction.
- Adapter Rail weight 9.1 oz.
- Combo includes: MAR6M2 + DBB130



DESIGNED IN USA
AR15 TRI-RAIL MOUNT/ RISER FOR FLAT-TOP

MODEL# MTRIF

SPECIFICATIONS	
LENGTH	5.2"
NET WEIGHT	6.5 oz.

US PATENT: D542880

- Mounts onto AR15 flat-top receiver, directly onto the Picatinny rail. Provides a raised platform for mounting optics higher for a more comfortable shooting position
- Two removable side rails for attaching accessories like a flashlight & laser
- Black anodized aluminum construction



GI HANDGUARD RAIL AR15/M4 GEN2 HANDGUARD RAIL
 [CARBINE LENGTH]

MODEL# MARSV2

SPECIFICATIONS	
LENGTH	5.9"
NET WEIGHT	1.7 oz.

- Improved AR15 GEN2 Picatinny rail.
- Handguard rail is Picatinny/ MIL-STD 1913 rails with more mounting holes for flexible mounting and increased ventilation. The ends of the rail have been rounded off for more comfort and to make it less snag prone.
- The GEN2 rail is tapered to match the standard GI carbine and M4 handguards. The taper in the rail will make accessories mounted to the rail parallel with your bore.
- Black anodized aluminum construction.
- Includes two mounting screws and flanged nuts. Allen wrench tool also included

AK MOUNTS



DESIGNED IN USA

AK RAIL & MICRO DOT
MOUNT RECEIVER COVER

MODEL# MAKMDV2

- Replaces existing AK-47 receiver cover. Fits AKM pattern rifles with a stamped receiver (7.62X39, 5.54X39, .223)
- The mount provides a low profile rail for mounting a scope or reflex optic onto the top receiver cover of your AKM pattern rifle.
- Provides a dedicated micro dot mount for installing an NcSTAR® micro dot directly to your AK with the lowest possible mounting height.
- Three front tabs and two rear screws are provided for a secure fit.
- Aluminum (rail) and steel construction (receiver cover)

SPECIFICATIONS

LENGTH	9.5"
NET WEIGHT	8.8 oz.

RED MICRO DOT REFLEX OPTIC
MODEL# DDAB
See page 22AK
COMBOSRED MICRO DOT MOUNT
WITH AK RECEIVER COVER

MODEL# DMAKR-A

- Replaces existing AK-47 receiver cover. Fits AKM pattern rifles with a stamped receiver (7.62X39, 5.54X39, .223)
- Provides a dedicated micro dot mount for installing a micro dot directly to your AK with the lowest possible mounting height
- Provides a rail on the receiver cover for mounting a scope or reflex optic
- Adjustable front tab and two rear set screws are provided for a secure fit
- Aluminum (rail) and steel construction (receiver cover)



RED DOT



GREEN DOT

ON/OFF Switch Type:
Standard ON/OFF switchGREEN MICRO DOT REFLEX OPTIC
MODEL# DDABG
See page 22AK
COMBOSGREEN MICRO DOT MOUNT
WITH AK RECEIVER

MODEL# DMAKG-A

SPECIFICATIONS	DDAB	DDABG
MAGNIFICATION	1X	1X
OBJECTIVE LENS DIAMETER	23.5X16.8 mm	23.5X16.8 mm
FIELD OF VIEW (ft @ 100 yds)	DOT SIZE: 2 MOA	DOT SIZE: 2 MOA
EYE RELIEF	N/A	N/A
EXIT PUPIL	N/A	N/A
WEIGHT (oz.)	8.5 oz	
OVERALL LENGTH (in)	9.5"	
CLICK VALUE @ 100 YDS	1 MOA	1 MOA
ILLUMINATION	Red	Green
LENS COATING	Ruby	Platinum
DIMENSIONS	1.9"L x 1.4"H x 1.2"D	

AK MOUNTS



DESIGNED IN USA
**AK TRI-RAIL
 RECEIVER COVER
 AND MOUNT**

MODEL# MTAK

SPECIFICATIONS	
LENGTH	9.3"
NET WEIGHT	11.2 oz.

- Replaces existing AK-47 receiver cover. Fits AKM pattern rifles with a stamped receiver (7.62X39, 5.54X39, .223)
- The mount provides three rails for mounting and optic onto the top rail and accessories on the side rails like a flashlight and/or laser
- The two side rails can be mounted in several positions for mounting flexibility, they are also removable
- Adjustable front tab and two rear set screws are provided for a secure fit
- Aluminum (rail) and steel construction (receiver cover)



DESIGNED IN USA
**AK COMBO
 SIGHTS N' LIGHTS**

MODEL# KAKSCRFS-A

- Fixed 4x30 scope and Bright 65 Lumen flashlight
- AK Tri-Rail Scope Mount
- 1" Weaver Style Split Rings
- Fits AKM pattern rifles with a stamped receiver (7.62X39, 5.54X39, .223).
- Aluminum (Rail) and Steel Construction (Receiver Cover)
- Combo includes: RB11 + ATFLB + MTAK + SC430B

4X30 COMPACT SCOPE
 MODEL# SC430B
 See page 31



DESIGNED IN USA
**4X30 COMPACT SCOPE WITH
 AK TRI RAIL COVER**

MODEL# KAKSC430B-A

- AK Tri Rail Cover with 4X30 Compact Scope and 1" Rings
- Fits AKM pattern rifles with a stamped receiver (7.62X39, 5.54X39, .223).
- 4X30 Compact Tactical Scope has one piece main tube, with Multi Coated Lenses, and includes lens caps.
- 1" Weaver Style Split Rings
- Combo includes: SC430B + RB01 + MTAK

4X30 COMPACT SCOPE
 MODEL# SC430B
 See page 31



DESIGNED IN USA
**KEYMOD™
 MOUNT RECEIVER COVER**

MODEL# VMTAKKM

SPECIFICATIONS	
LENGTH	9.5"
NET WEIGHT	7.7 oz.

- Replaces existing AK-47 receiver cover. Fits AKM pattern rifles with a stamped receiver (7.62X39, 5.54X39, .223)
- The mount provides a low profile KeyMod™ mounting surface on three sides of the receiver cover for mounting an optic mount and accessories to onto the top or sides of the receiver cover of your AKM pattern rifle.
- The top KeyMod™ surface is pre-drilled for mounting an NcSTAR® micro dot directly to the top of your AK with the lowest possible mounting height. This allows the NcSTAR® micro dot to co-witness with AK Iron sights.
- Adjustable front tab and two rear screws are provided for a secure fit.
- Aluminum (rail) and steel construction (receiver cover)



DESIGNED IN USA
**AK PICATINNY
 RAIL MOUNT RECEIVER COVER**

MODEL# MAK

SPECIFICATIONS	
LENGTH	9.5"
NET WEIGHT	8.7 oz.

- Low Profile AK Picatinny rail mount receiver cover.
- Replaces existing AK-47 receiver cover. Fits AKM pattern rifles with a stamped receiver (7.62X39, 5.54X39, .223)
- The mount provides a low profile rail for mounting an Optic onto the top receiver cover of your AKM pattern rifle.
- Three front tabs and two rear screws are provided for a secure fit.
- Aluminum (rail) and steel construction (receiver cover)

AK MOUNTS



DESIGNED IN USA

AK KEYMOD™ HANDGUARD

[EXTENDED LENGTH]

MODEL# VMAKKME

TOP HANDGUARD:

Pre-drilled and compatible with NcSTAR's micro dot optics. Offering the lowest micro dot mounting position to co-witness with the AK iron sights.

// KeyMod™ slots at 8 angled surfaces for mounting your accessories.

INCLUDES:

- 2.4" **SHORT** (3 KeyMod™) Accessory Rail

DROP-IN INSTALLATION:

No gunsmithing required, includes mounting bolts & tool

- Black anodized aluminum construction.

SPECIFICATIONS

LENGTH	10.8"
NET WEIGHT	10.7"
WEIGHT (+RAILS)	11.5 oz.



DESIGNED IN USA

AK KEYMOD™ HANDGUARD

[STANDARD LENGTH]

MODEL# VMAKKMS

TOP HANDGUARD:

Pre-drilled and compatible with NcSTAR's micro dot optics. Offering the lowest micro dot mounting position to co-witness with the AK iron sights.

// KeyMod™ slots at 8 angled surfaces for mounting your accessories.

INCLUDES:

- 2.4" **SHORT** (3 KeyMod™) Accessory Rail

DROP-IN INSTALLATION:

No gunsmithing required, includes mounting bolts & tool

- Black anodized aluminum construction.

SPECIFICATIONS

LENGTH	6.3"
NET WEIGHT	6.7"
WEIGHT (+RAILS)	7.5 oz.



AK SIDE MOUNTED OPTICS RAIL

MODEL# MSAK

- This mount slides onto AK models equipped with the side rail and securely clamps down with the three Allen head bolts. Mounting tools included
- Provides a rail over the receiver cover for mounting a scope or reflex optic
- There is also a side rail on the mount for mounting accessories like flashlight and laser

SPECIFICATIONS

LENGTH	5.3"
HEIGHT	3.5"
NET WEIGHT	6.7 oz.

DESIGNED IN USA

MOSSBERG 500® SHOTGUN RAILS & BAYONET MOUNT

MODEL# MSHBAYMOS

- 1" shotgun magazine tube mount with Picatinny Rails, Sling Stud, & Bayonet Lug for the Mossberg® 500 12 gauge shotgun. Fits most home defense models with the extended capacity 12G. magazine tube.
- Shotgun magazine tube mount includes two removable Picatinny accessory rails, a sling swivel stud, and the bayonet lug for securing M7 & M9 Bayonets. Includes front magazine tube cap that interfaces with the bayonet front barrel/muzzle ring mount.
- Easy to install onto the shotgun. Bayonet locks into place.
- Includes 2 side Picatinny accessory rails for mounting a flashlight and laser to your shotgun.
- Mounting bolts and tools included
- Black anodized aluminum construction

SPECIFICATIONS	
LENGTH	1.7"
NET WEIGHT	3.6 oz.

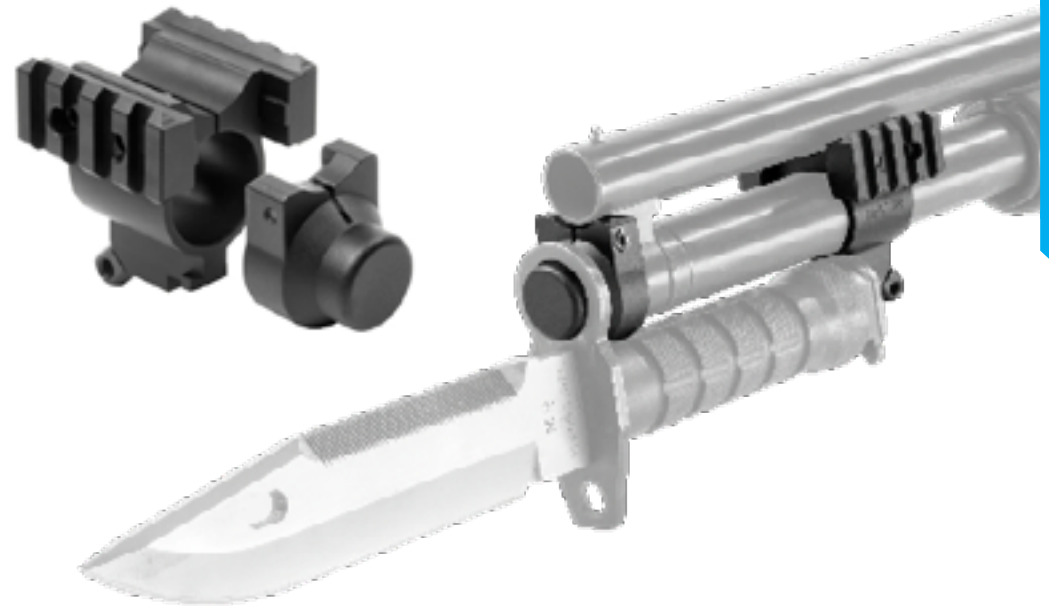

▪ BAYONET NOT INCLUDED

DESIGNED IN USA

REMINGTON 870™ SHOTGUN RAILS & BAYONET MOUNT

MODEL# MSHBAYREM

- 1" shotgun magazine tube mount with Picatinny rails, sling stud, & bayonet lug for the Remington® 870 12 gauge shotgun. Fits most home defense/ police models with the factory Remington® extended capacity 12G. magazine tubes with the reduced diameter front section.
- Shotgun magazine tube mount includes two removable Picatinny accessory rails, a sling swivel stud, and the bayonet lug for securing M7 & M9 Bayonets.
- Easy to install onto the shotgun. Bayonet locks into place.
- Includes 2 side Picatinny accessory rails for mounting a flashlight and laser to your shotgun.
- Works with some Remington® 1100/ 11-87 models with the factory Remington® extended magazine tubes with the reduced diameter front section.
- Mounting bolts and tool included
- Black anodized aluminum construction

SPECIFICATIONS	
LENGTH	1.7"
NET WEIGHT	2.7 oz.

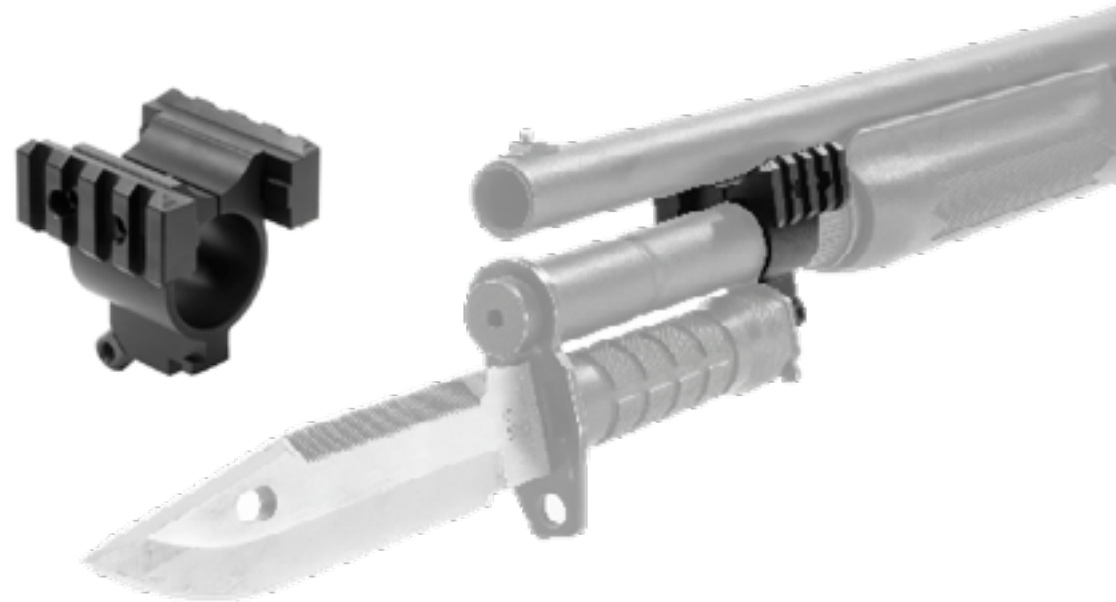

▪ BAYONET NOT INCLUDED

SHOTGUN MOUNTS



MOSSBERG 500® SHOTGUN RECEIVER RAIL MOUNT

MODEL# MSHRCVMOS

SPECIFICATIONS

LENGTH	5.4"
NET WEIGHT	1.3 oz.

- Mossberg 500®/590® receiver Picatinny rail mount for mounting optics to your shotgun.
- Low profile Picatinny rail design with see-through channel allows you to still use the front bead sight.
- Screws included for mounting rail to shotgun receiver.
- All aluminum construction. Black anodized finish
- Rail is designed to fit Mossberg 500®/590® models with the factory pre-drilled holes on top of the shotgun receiver.



*Fits most MOSSBERG 590® models



DESIGNED IN USA

MOSSBERG 500®/590® SHOTGUN BARREL MICRO DOT RAIL MOUNT

US PATENT: D732,634

MODEL# MSHBDMOS

- The Mount and rails are fully customizable. The mount can be configured into a dozen different configurations to suite the shooter's requirements.
- Dedicated cantilevered micro dot mount is compatible with NcSTAR® micro-dot reflex optics: DDAB, DDABG, DDABL,
- Includes two side Weaver/Picatinny type rails for attaching accessories like flashlights & lasers to your shotgun.
- Black anodized aluminum construction

DESIGNED IN USA

REMINGTON 870™ SHOTGUN BARREL MICRO DOT RAIL MOUNT

US PATENT: D732,634

MODEL# MSHBDREM

SPECIFICATIONS

LENGTH	2.6"
HEIGHT	3.1"
NET WEIGHT	5.5 oz.



INCLUDES:
Rail Adapter for the Micro-Dot Base for mountin Weaver/Picatinny type accessories/optics on top of the cantilever mount.



1" SHOTGUN MAGAZINE TUBE MOUNT

MODEL# MT12

- Mounts onto 1" 12 gauge shotgun magazine extension tubes
- Allows the shooter to mount accessories to their shotgun like flashlights and lasers
- 5 different angled rails to mount accessories to. The standard 3,6, and 9 o'clock positions with the 4-5 & 7-8 o'clock
- Black anodized aluminum construction

SPECIFICATIONS

LENGTH	1.4"
NET WEIGHT	1.4 oz.



DESIGNED IN USA

12G SHOTGUN SIDE SADDLE 4/6 SHELLS

MODEL# A12SH46

- Holds 6 each 12 gauge shotshells
- Two piece design with dovetail slot so that the side saddle can be configured for 4 or 6 shells
- Heavy duty hook and loop fastener included for mounting onto most shotgun receivers
- Black anodized aluminum construction

SPECIFICATIONS

LENGTH	6.1"
NET WEIGHT	4.3 oz.

SHOTGUN COMBOS



*Fits most MOSSBERG 590® models

MOSSBERG 500®/590® SHOTGUN BARREL MICRO DOT RAIL MOUNT WITH RED DOT

MODEL# MSHBDMOSR-A



REMINGTON 870™ SHOTGUN BARREL MICRO DOT RAIL MOUNT WITH RED DOT

MODEL# MSHBDREMR-A



*Fits most MOSSBERG 590® models

MOSSBERG 500®/590® SHOTGUN BARREL MICRO DOT RAIL MOUNT WITH GREEN DOT

MODEL# MSHBDMOSG-A



REMINGTON 870™ SHOTGUN BARREL MICRO DOT RAIL MOUNT WITH GREEN DOT

MODEL# MSHBDREMG-A

- Micro dot base on the barrel and magazine rail/mount allows you to mount the DDAB and DDABG as low as possible on the rail.
- Micro dot reflex optic with standard ON/OFF switch LED 100% safe for the eyes
- Unlimited eye relief
- Powered by a 3 volt lithium battery (CR2032) included
- Includes extra battery, lens covers, and mounting/ adjustment tools
- The mount and rails are fully customizable. The mount can be configured into a dozen different ways to suit the shooter's requirements.
- Includes rail adapter for the micro-dot base for mounting Weaver/Picatinny type accessories/optics on top of the cantilever mount.
- Includes two side Weaver/Picatinny type rails for attaching accessories like flashlights & lasers to your shotgun.
- All aluminum construction. Black anodized finish

MICRO DOT REFLEX OPTIC
 MODELS: DDAB OR DDABG
 See page 22



INCLUDES:
 Rail Adapter for the Micro-Dot Base for mounting Weaver/Picatinny type accessories/optics on top of the cantilever mount.



RED DOT GREEN DOT

ON/OFF Switch Type:
 Standard ON/OFF switch

SPECIFICATIONS	DDAB	DDABG
MAGNIFICATION	1X	1X
OBJECTIVE LENS DIAMETER	23.5X16.8 mm	23.5X16.8 mm
FIELD OF VIEW (ft @ 100 yds)	DOT SIZE: 2 MOA	DOT SIZE: 2 MOA
EYE RELIEF	N/A	N/A
EXIT PUPIL	N/A	N/A
WEIGHT (oz.)	8.5 oz	
OVERALL LENGTH (in)	9.5"	
CLICK VALUE @ 100 YDS	1 MOA	1 MOA
ILLUMINATION	Red	Green
LENS COATING	Ruby	Platinum
DIMENSIONS	2.7"L x 3.6"H x 2.4"D	

RUGER MOUNTS



DESIGNED IN USA

RUGER® PC CARBINE™ RMR® FOOTPRINT AND REAR SIGHT MOUNT

US PATENT PENDING

MODEL# VMRUPCCMD

SPECIFICATIONS

LENGTH	3.1"
NET WEIGHT	1.2 oz.

*Ruger® is a trademark of by Sturm, Ruger & Co., Inc.,
*RMR® is a trademark of Trijicon

- Micro dot base mount and rear sight base accessory for the Ruger® PC Carbine™.
- Base mount replaces the factory rear sight base and allows the mounting of NcSTAR® and other micro dot optics as low as possible to the barrel.
- Allowing the micro dot to co-witnessing with the iron sights.
- This Micro dot base is compatible with NcSTAR® FlipDot optic series, SPD Solar Micro dot, and any other optics with an RMR® footprint base.
- This micro dot base mounts bolts directly to the barrel rear sight base and the factory windage and elevation iron rear sight bolts onto the rear of the mount.



Micro Dot not included



DESIGNED IN USA

RUGER® PC CARBINE™ PICATINNY RAIL AND REAR SIGHT BASE

US PATENT PENDING

MODEL# VMRUPCC1913

- This 3.6" long Picatinny/ MIL-STD 1913 rail mount replaces the factory rear sight base and allows the mounting of optics directly to PC Carbine® barrel.
- This rail mount bolts directly to the barrel rear sight base and the factory windage and elevation iron rear sight bolts onto the rear of the mount.

*Ruger® is a trademark of by Sturm, Ruger & Co., Inc.,

SPECIFICATIONS

LENGTH	5.0"
NET WEIGHT	1.4 oz.



DESIGNED IN USA

RUGER® 10/22® RECEIVER PICATINNY

MODEL# MRUB1022V2

- Mounts onto the top of 10/22® receivers utilizing the pre-drilled holes on the receiver.
- Centerline sight channel machined into the rail so that you can still use the factory iron sights with the rail mounted onto the receiver.
- Includes mounting hardware (no rifle modifications necessary)
- Black anodized aluminum construction

SPECIFICATIONS

LENGTH	4.7"
NET WEIGHT	1.1 oz.



DESIGNED IN USA

RUGER® 10/22® SEE-THROUGH RECEIVER PICATINNY

MODEL# MRUHB1022V2

- Mounts onto the top of 10/22® receivers utilizing the pre-drilled holes on the receiver.
- Shooter is still able to use the factory iron sights by looking through sight channel below the Picatinny Rail.
- Includes mounting hardware (no rifle modifications necessary)
- Black anodized aluminum construction

SPECIFICATIONS

LENGTH	4.7"
NET WEIGHT	1.6 oz.



DESIGNED IN USA

RUGER® MINI14 GEN2 PICATINNY SCOPE RAIL MOUNT

MODEL# MRUBV2

- Mounts onto Ruger® models that have the Ruger® ring mounts machined onto the top of the receiver. To include Mini 14, Mini 30, PC9, and PC4 rifles and carbines.
- Provides a Picatinny/ MIL-STD 1913 rail on the top of the receiver for mounting a Scope or Reflex optic. The GEN2 Rail has a see-through channel running the length of the rail that allows the shooter to see and use the iron sights when the rail is mounted on the receiver.
- Mounts with four custom bolts, mounting tool included.
- Black anodized aluminum construction

SPECIFICATIONS

LENGTH	5.2"
NET WEIGHT	1.6 oz.

RUGER MOUNTS & SKS MOUNTS



DESIGNED IN USA

**SKS
TRI-RAIL RECEIVER COVER**

US PATENT: D543605

MODEL# MTSKS

SPECIFICATIONS

LENGTH	4.9"
NET WEIGHT	10.1 oz.

- Replaces existing SKS receiver cover and provides three rails for mounting.
- The two side rails can be removed or mounted in several positions.
- 4 side set screws allow you to lock the receiver cover for a secure fit.
- See-through design allows you to use the iron sights while mounted.
- Aluminum (rail) and steel construction (receiver cover)



4X30 COMPACT SCOPE

MODELS# SC430B

See page 31

DESIGNED IN USA

**4X30 COMPACT SCOPE AND SKS
TRI-RAIL RECEIVER COVER**

US PATENT: D543605

MODEL# KSKSC430B-A

SPECIFICATIONS

LENGTH	8.7"
NET WEIGHT	19.7 oz.

- SKS Tri Rail Cover with 4X30 Compact Scope and 1" Rings
- The perfect kit to customize your SKS pattern rifle.
- SKS Weaver Style Tri-Rail Mount and Receiver Cover.
- Replaces existing SKS receiver cover and provides Three Rails for mounting and on top and accessories on the sides
- 4X30 Compact Tactical Scope has one piece main tube, with Multi Coated Lenses, includes lens caps.
- Combo also includes a pair 1" Aluminum Weaver Style Rings.
- Combo includes: VR1H09 + SC430B + MTSKS



DESIGNED IN USA

**RUGER® MK2 PISTOL
MICRO DOT MOUNT**

MODEL# MRUMK2

SPECIFICATIONS

LENGTH	1.8"
NET WEIGHT	0.8 oz.

- Low profile micro dot base for Ruger® Mark II™ and Mark III™ pistols.
- Compatible with all NcSTAR® micro dots.
- Drop-in installation with mounting screws included.
- Black anodized aluminum construction.



DESIGNED IN USA

**SKS
GAS TUBE SCOPE MOUNT WITH SIDE
RAILS**

US PATENT: D732628

MODEL# MSKSV2

SPECIFICATIONS

LENGTH	9.8"
NET WEIGHT	12.1 oz.

- SKS gas tube scope mount that replaces the factory gas tube and upper handguard. Picatinny rail on top is designed to allow shooters to mount optics with long eye relief
- Two set screws secure the mount to the rear sight trunnion for a solid optics mounting platform
- Low profile Picatinny rail with a sight channel down the middle to allow the use of iron sights
- Great for long eye relief scout scopes or reflex dot sights
- Two Picatinny side rails included, that can be mounted into any of the six ventilation holes and are also removable
- The gas tube is manufactured just slightly longer by a few thousandths, so that it can be hand fitted to the various manufacturers of SKS rifles. Some hand fitting may be required for a secure fit
- Aluminum (rail) and steel construction (gas tube)

HANDGUN MOUNTS



1911 PISTOL TRIGGER GUARD MOUNT/ WEAVER RAIL

MODEL# MAD1911

- Clamps onto Colt® style 1911 (Series 70) models
- The mount clamps securely onto the trigger guard
- Black anodized aluminum construction

SPECIFICATIONS

LENGTH	3.2"
NET WEIGHT	1.3 oz.



GLOCK® 9MM/.40 TRIGGER GUARD MOUNT/ RAIL

MODEL# MADGLO

- Clamps onto early generation GLOCK® 9mm/.40 S&W handgun models and provides a Weaver type rail for attaching flashlight or laser
- The mount clamps securely onto the trigger guard
- Fits G26 & G27 sub compact models
- Black anodized aluminum construction

SPECIFICATIONS

LENGTH	3.2"
NET WEIGHT	1.5 oz.



BERETTA® 92/M9 TRIGGER GUARD MOUNT/ RAIL

MODEL# MADBER

- Clamps onto Beretta® 92/M9 handguns and provides a Weaver type rail for attaching flashlight or laser
- The mount clamps securely onto the trigger guard
- Black anodized aluminum construction

SPECIFICATIONS

LENGTH	3.3"
NET WEIGHT	1.4 oz.

DESIGNED IN USA

MICRO DOT SLIDE DOVETAIL MOUNT

MODEL# VMRMRGLK

- Dovetail Base is designed for GLOCK® slides.
- Replaces GLOCK® rear dovetail sights.
- Optic Plate is compatible with RMR™ type base and optics.
- Steel construction
- Installation Tools (Included)

SPECIFICATIONS

LENGTH	1.8"
NET WEIGHT	1.2 oz.



RAIL ADAPTERS



DESIGNED IN USA

M-LOK® AND KEYMOD™ ACCESSORY RAIL [SHORT]



MODEL# VMMK3B

- 3 Slot Picatinny rail
- Tapered profile design
- Mounts onto M-LOK®/KeyMod™ handguards
- Covers 1.5 M-LOK® slots / 3 KeyMod™ slots
- Aluminum construction

PROVIDES
3
SLOTS
PICATINNY

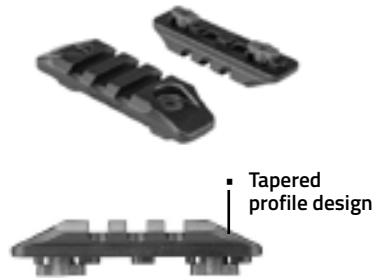

Tapered profile design

SPECIFICATIONS	
LENGTH	2.6"
WEIGHT	0.8 oz.



DESIGNED IN USA

M-LOK® AND KEYMOD™ ACCESSORY RAIL [MEDIUM]



MODEL# VMMK5B

- 7 Slot Picatinny rail
- Tapered profile design
- Mounts onto M-LOK®/KeyMod™ handguards
- Covers 2.5 M-LOK® slots / 5 KeyMod™ slots
- Aluminum construction

PROVIDES
7
SLOTS
PICATINNY

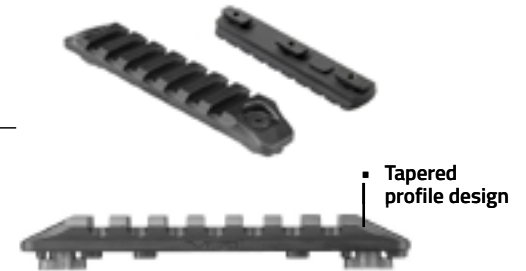

Tapered profile design

SPECIFICATIONS	
LENGTH	4.0"
WEIGHT	1.2 oz.

DESIGNED IN USA

M-LOK® PICATINNY RAIL ACCESSORY RAIL



M-LOK® ACCESSORY RAIL [SHORT]



PROVIDES
5
SLOTS
PICATINNY

M-LOK® ACCESSORY RAIL [MEDIUM]



PROVIDES
9
SLOTS
PICATINNY

		BLACK	TAN
2.4"	SHORT	MODEL# VMML3	MODEL# VMML3T
4.0"	MEDIUM	MODEL# VMML6	MODEL# VMML6T

SPECIFICATIONS	SHORT	MEDIUM
LENGTH	2.4"	4.0"
HEIGHT	0.5"	0.5"
DEPTH	0.8"	0.8"

DESIGNED IN USA

KEYMOD™ PICATINNY RAIL ACCESSORY RAIL



KEYMOD™ ACCESSORY RAIL [SHORT]



PROVIDES
5
SLOTS
PICATINNY

KEYMOD™ ACCESSORY RAIL [MEDIUM]



PROVIDES
11
SLOTS
PICATINNY

		BLACK	TAN
2.4"	SHORT	MODEL# VMKM3	MODEL# VMKM3T
4.0"	MEDIUM	MODEL# VMKM6	MODEL# VMKM6T

SPECIFICATIONS	SHORT	MEDIUM
LENGTH	2.4"	4.0"
HEIGHT	0.5"	0.5"
DEPTH	0.8"	0.8"

SPECIALIZED MOUNTS



ACTION CAMERA
NOT INCLUDED

DESIGNED IN USA

ACTION CAMERA MOUNT (KPM) US PATENT PENDING

MODEL# VMACKPM

- Will mount onto Picatinny/MIL-STD 1913 rails, KeyMod™ and M-LOK® handguards.
- Reversible mounting plate for mounting onto KeyMod™ or M-LOK® handguard slots.
- Action cameras can be mounted onto the top or bottom of the mount, and rotated/pivoted in all directions to capture that perfect camera angle.
- Solid solution for mounting an action camera to your rifles, shotguns, pistols, airsoft, and paintball markers to record your training, competition, hunting, and MilSim games.
- Constructed with durable and lightweight aluminum.
- Includes metal tripod thumb screw and plastic GoPro™ tripod base adapter.
- Includes the tools and hardware to mount onto Picatinny/MIL-STD 1913 rails, KeyMod™ and M-LOK® handguards.



SPECIFICATIONS

LENGTH	1.8"
WIDTH	2.2"
HEIGHT	1.6"
NET WEIGHT	3.2 oz.



OPTIC RAIL MOUNT WITH *HK® CLAW MOUNT

MODEL# MDMP5V2

- *HK® MP5/CETME Weaver style optic rail mount (HK claw mount type).
- Clamps directly to the top of the HK® spec stamped receivers
- Black anodized aluminum construction

SPECIFICATIONS

LENGTH	5.4"
NET WEIGHT	2.5 oz.

*HK is a trademark of Heckler & Koch, Inc



45° OFFSET RAIL MOUNT

MODEL# MPR45

- 45° off-set rail mount for easier access or clearance
- Mount an optic, flashlight or laser at a 45° angle
- Black anodized aluminum construction

SPECIFICATIONS

LENGTH	1.8"
NET WEIGHT	1.6 oz.



*MARLIN® RECEIVER SCOPE MOUNT

MODEL# MMLINV2

- *Marlin® receiver scope mount will fit most lever action and some semi-auto receivers with pre-drilled holes
- Various mounting hole options for different types of receivers
- Black anodized aluminum construction

SPECIFICATIONS

LENGTH	4.7"
NET WEIGHT	1.0 oz.

*Marlin is a trademark of Marlin Firearms, Madison, Inc



DESIGNED IN USA

3/8 DOVETAIL TO PICATINNY ADAPTER RAIL [SHORT]

MODEL# MAD38PS

- Attaches to 3/8 dovetail rails and converts it to a Picatinny rail for mounting red dot optics with Weaver/Picatinny type mounts
- Two integrated set screws for securing rail adapter in place
- Black anodized aluminum construction

SPECIFICATIONS

LENGTH	3.8"
NET WEIGHT	1.0 oz.

SPECIALIZED MOUNTS & RISER MOUNTS



DESIGNED IN USA

UNIVERSAL BLACK POWDER RAIL

MODEL# VMUBPR

- This universal 4.8" long Picatinny/ MIL-STD 1913 rail has multiple mounting holes machined along the centerline of the rail to allow it fit most of the CVA/ Traditions/ Thompson Center black powder gun models.
- The centerline (0.26"H) of the rail has been machined down to allow the use of most iron sights.
- Top of Picatinny rail is 0.38"H above the receiver.
- Includes #8-40 (4 each) & #6-48 (4each) screws to mount onto most of the compatible black powder guns.
- Black anodized aluminum construction

SPECIFICATIONS

LENGTH	4.8"
NET WEIGHT	1.5 oz.



DESIGNED IN USA

GEN2 AR15 ¾" RISER WITH LOCKING QR MOUNT

MODEL# MARFQV2

- Helps with getting low profile optic mounts to a more comfortable cheek rest height and shooting position.
- Mounts via a locking quick release mount onto the Picatinny rail of your AR15/M4 receiver. You can quickly attach and remove your optic from your receiver and maintain your zero.
- There is a see through channel below the rail to keep the mount lighter and for some firearm types, it may allow you to use some factory iron sights.
- Black anodized aluminum construction

SPECIFICATIONS

LENGTH	5.3"
NET WEIGHT	4.2 oz.



DESIGNED IN USA

GEN2 AR15 ¾" RISER [SHORT]

MODEL# MARFSV2

- Works on AR15/M4 platforms as well as any other firearms platforms with a Weaver/ Picatinny/ MIL-STD 1913 rail.
- This riser helps with raising optics up another ¼ of an inch to a more comfortable cheek rest and shooting height.
- The rail has a hollow channel through the length to make it lighter and for some firearms act as a see-through sight channel to use the iron sights.
- Black anodized aluminum construction

SPECIFICATIONS

LENGTH	2.1"
NET WEIGHT	1.9 oz.



DESIGNED IN USA

GEN2 AR15 ¾" RISER [LONG]

MODEL# MARFV2

- Works on AR15/M4 platforms as well as any other firearm platforms with a Weaver/ Picatinny/ MIL-STD 1913 rail.
- Helps with getting low profile optic mounts to a more comfortable cheek rest height and shooting position.
- The rail has a hollow channel through the length to make it lighter and for some firearms act as a see-through sight channel to use the iron sights.
- Black anodized aluminum construction

SPECIFICATIONS

LENGTH	5.2"
NET WEIGHT	4.2 oz.

1" RING MOUNT

KEYMOD™ RING MOUNTS



DESIGNED IN USA

KEYMOD™ EXTENDED 1" RING MOUNT [FIXED]

MODEL# VMFLKM



DESIGNED IN USA

KEYMOD™ EXTENDED 1" RING MOUNT [MODULAR]

MODEL# VMFLKMMR

- Attaches onto 2 KeyMod™ slot
- 1" Ring mount for 1" flashlight/lasers.
- Lightweight aluminum construction.

SPECIFICATIONS	VMFLKM	VMFLKMMR
LENGTH	3.5"	3.5"
NET WEIGHT	1.5 oz.	2.8 oz.
ATTACHES TO:	KeyMod™	
MATERIAL	Aluminum	

M-LOK® RING MOUNTS



DESIGNED IN USA

M-LOK® EXTENDED 1" RING MOUNT [FIXED]

MODEL# VMFLML



DESIGNED IN USA

M-LOK® EXTENDED 1" RING MOUNT [MODULAR]

MODEL# VMFLMLMR

- Attaches to virtually any M-LOK® slots
- 1" Ring mount for 1" flashlight/lasers.
- Lightweight aluminum construction.

SPECIFICATIONS	VMFLML	VMFLMLMR
LENGTH	4.3"	4.3"
NET WEIGHT	1.8 oz.	3.1 oz.
ATTACHES TO:	M-LOK®	
MATERIAL	Aluminum	

PICATINNY RING MOUNTS



DESIGNED IN USA

PICATINNY EXTENDED 1" RING MOUNT [FIXED]

MODEL# VMFLPR



DESIGNED IN USA

PICATINNY EXTENDED 1" RING MOUNT [MODULAR]

MODEL# VMFLPRMR

- Attaches to virtually any Weaver/Picatinny/
MIL-STD 1913 type rails.
- 1" Ring mount for 1" flashlight/lasers.
- Lightweight aluminum construction.

SPECIFICATIONS	VMFLPR	VMFLPRMR
LENGTH	3.5"	3.5"
NET WEIGHT	1.7 oz.	3.1 oz.
ATTACHES TO:	Picatinny	
MATERIAL	Aluminum	

1" RING MOUNT

WEAVER/ PICATINNY



1" WEAVER QUICK RELEASE STEEL RINGS
[1.0" HEIGHT]

MODEL# RB33

- Adjustable Quick Release Lever mount. Adjustment tool included
- Mounts onto Weaver/ Picatinny/ MIL-STD 1913 type rails.
- Black anodized aluminum construction



1" WEAVER ALUMINUM RINGS
[1.2" HEIGHT]

MODEL# RB11

- Mounts onto Weaver/ Picatinny/ MIL-STD 1913 type rails.
- Black anodized aluminum construction

SPECIFICATIONS	RB33	RB11
OVERALL HEIGHT	1.7"	2.1"
OPTIC HEIGHT	1.0"	1.2"
NET WEIGHT	3.4 oz.	3.8 oz.
ATTACHES TO:	Picatinny	
MATERIAL	Aluminum	



1" OFFSET MOUNT FOR FLASHLIGHT AND LASER

MODEL# MFL1

SPECIFICATIONS

LENGTH	1.2"
NET WEIGHT	2.2 oz.

- This Mount will off-set your 1" accessories like flashlights & lasers for easier access or for better clearance
- Mounts to Weaver and Picatinny type rails
- Black anodized aluminum construction

PICATINNY



HUNTER RINGS



DESIGNED IN USA

HUNTER SERIES 1" RING
[0.9" HEIGHT]

MODEL# VR1H09



DESIGNED IN USA

HUNTER SERIES 1" RING
[1.3" HEIGHT]

MODEL# VR1H13



DESIGNED IN USA

HUNTER SERIES 1" RING
[1.5" HEIGHT]

MODEL# VR1H15

- 1" Scope Tube Diameter Ring.
- Mounts onto/ Picatinny/ MIL-STD 1913 type rails.
- Hexagon shape mounting nut, with holes for torquing with Allen key wrench.
- Black anodized aluminum construction

SPECIFICATIONS	VR1H09	VR1H13	VR1H15
OVERALL HEIGHT	1.7"	2.1"	2.4"
OPTIC HEIGHT	0.9"	1.3"	1.5"
NET WEIGHT	3.4 oz.	3.8 oz.	4.0 oz.
ATTACHES TO:	Picatinny		
MATERIAL	Aluminum		

US PATENT: D777289

3/8" DOVETAIL



3/8" DOVETAIL RINGS
[1.1" HEIGHT]

MODEL# RB25

- 1" diameter scope rings
- Mounts onto 3/8" dovetail rails
- Black anodized aluminum construction



3/8" DOVETAIL RINGS
[1.4" HEIGHT]

MODEL# RB27

- 1" diameter scope rings
- Mounts onto 3/8" dovetail rails
- Black anodized aluminum construction



HUNTER RINGS



DESIGNED IN USA

HUNTER SERIES 3/8" DOVETAIL RINGS
[0.9" HEIGHT]

MODEL# VR38D09

- 1" diameter scope rings
- Mounts onto 3/8" dovetail rails
- Black anodized aluminum construction



DESIGNED IN USA

HUNTER SERIES 3/8" DOVETAIL RINGS
[1.3" HEIGHT]

MODEL# VR38D13

- 1" diameter scope rings
- Mounts onto 3/8" dovetail rails
- Black anodized aluminum construction

SPECIFICATIONS	RB25	RB27	VR38D09	VR38D13
OVERALL HEIGHT	1.8"	2.0"	1.6"	2.0"
OPTIC HEIGHT	1.1"	1.4"	0.9"	1.3"
NET WEIGHT	3.1 oz.	3.8 oz.	3.4 oz.	2.9 oz.
ATTACHES TO:	3/8 Dovetail			
MATERIAL	Aluminum			

30MM/1" RING MOUNT



DESIGNED IN USA

30MM FLIP-TO-SIDE MAGNIFIER MOUNT WITH LOCKING QR

MODEL# MAGFL

- Push button flip-to-side
- Works with 30mm magnifiers
- Scope center line at 1.5" AR15 height
- Locking quick release mount
- Attaches to virtually any Weaver/ Picatinny/ MIL-STD 1913 type rails
- Black anodized aluminum construction

DESIGNED IN USA

6 BOLT -1.5" RING WITH LOCKING QR MOUNT

MODEL# RB24QR



- Mounts onto Weaver/ Picatinny/ MIL-STD 1913 type rails
- Wide 6 bolt pattern ring
- Works with 30mm scopes and reflex optics
- Mount height is at the 1.5" AR15 height for co-witnessing with the iron sights
- Locking quick release mount
- Black anodized aluminum body

DESIGNED IN USA

ADJUSTABLE HEIGHT 30MM RING

MODEL# RAH24



- Turn the elevation wheel to raise or lower the ring height
- Set screws on each side to lock the ring height in place
- Mounts onto Weaver/ Picatinny/ MIL-STD 1913 type rails
- Optic center height can be adjusted: 1.39" - 1.56"
- Includes 1" ring inserts



DESIGNED IN USA

GEN II 30MM CANTILEVER SCOPE MOUNT WITH DUAL QR MOUNT

MODEL# VMSPRBV2

- Scope centerline at 1.5" AR15 height
- Reversible (left or right side) 45° offset rail mount for mounting a secondary Optic, such as a micro dot reflex optic for close range targets
- Dual locking quick release mounts, allows you to quickly mount a 30mm scope onto your Picatinny rail
- Includes 1" inserts. mount works with both 30mm and 1" scopes
- Black anodized aluminum construction



DESIGNED IN USA

AR15 ADJUSTABLE SCOPE MOUNT QR

MODEL# MARCQ

- 30mm AR15 scope mount with locking quick release.
- Allows you to quickly mount a 30mm or 1" scope onto your Picatinny rail
- Front fixed cantilever ring with an adjustable for length rear ring (rear ring is also removable)
- Includes 1" inserts. mount works with both 30mm and 1" scopes
- Black anodized aluminum construction



KEYMOD

DESIGNED IN USA

LOW PROFILE KEYMOD™ SCOPE MOUNT

MODEL# VMLPKMS

- 30 mm rings with 1" inserts.
- Lightweight and low profile
- 1.8" center ring gap
- Works with 30mm and 1" full-size scopes
- Optic centerline: 1.0"
- Black anodized aluminum construction



30MM CANTILEVER OPTIC MOUNT

MODEL# MDC30

- Mounts your optic forward to give you more eye relief or rail space behind the optic for a magnifier, iron sight, or other accessories
- Works with 30mm, 1 inch scopes & reflex optics
- Mount height is at the 1.5" AR15 height for co-witnessing with your iron sights
- Mounts securely to your firearm with the slotted thumb nut
- Black anodized aluminum construction

DESIGNED IN USA

LOW PROFILE KEYMOD™ RING MOUNT

MODEL# VMLPKMR

- 30 mm ring with 1" inserts.
- Lightweight and low profile
- Works with 30mm reflex optics & magnifiers
- Optic centerline: 1.0"
- Black anodized aluminum construction



KEYMOD

SPECIFICATIONS	MAGFL	RB24QR	RAH24	MDC30	VMLPKMR	VMSPRBV2	MARCQ	VMLPKMS
LENGTH	2.4"	2.0"	0.8"	2.2"	2.8"	6.3"	4.0"	3.8"
OPTIC HEIGHT	1.5"	1.5"	1.39" - 1.56"	1.5"	1.0"	1.5"	1.5"	1.0"
NET WEIGHT	3.6 oz.	3.7 oz.	3.7 oz.	3.3 oz.	2.3 oz.	3.6 oz.	3.7 oz.	2.3 oz.
ATTACHES TO:	Weaver/ Picatinny				KeyMod™	Picatinny		KeyMod™
MATERIAL	Aluminum							

30MM/1" RING MOUNT



WEAVER RINGS
[0.9" HEIGHT]

MODEL# RB26



WEAVER RINGS
[1.5" HEIGHT]

MODEL# RB24

- 30mm Heavy Duty Weaver Rings with 1" Inserts
- Mounts onto Weaver and Picatinny type rails. Large thumb nut for easy installation
- Rings mount onto 30mm & 1" scope tubes
- Black anodized aluminum construction

SPECIFICATIONS	RB26	RB24
OVERALL HEIGHT	1.9"	2.4"
OPTIC HEIGHT	0.9"	1.5"
NET WEIGHT	5.0 oz.	6.2 oz.
ATTACHES TO:	Picatinny	
MATERIAL	Aluminum	
FEATURE	1" Inserts	



HUNTER RINGS



DESIGNED IN USA

**HUNTER SERIES
30MM RINGS**
[0.9" HEIGHT]

MODEL# VR30H09



DESIGNED IN USA

**HUNTER SERIES
30MM RINGS**
[1.3" HEIGHT]

MODEL# VR30H13



DESIGNED IN USA

**HUNTER SERIES
30MM RINGS**
[1.5" HEIGHT]

MODEL# VR30H15

- 30mm scope tube diameter rings with removable 1" inserts.
- Mounts onto / Picatinny/ MIL-STD 1913 type rails.
- Black anodized aluminum construction

SPECIFICATIONS	VR30H09	VR30H13	VR30H15
OVERALL HEIGHT	1.9"	2.2"	2.5"
OPTIC HEIGHT	0.9"	1.3"	1.5"
NET WEIGHT	4.1 oz.	4.7 oz.	4.9 oz.
ATTACHES TO:	Picatinny		
MATERIAL	Aluminum		
FEATURE	1" Inserts		

US PATENT: D777289



TACTICAL RINGS



DESIGNED IN USA

**TACTICAL SERIES
30MM RINGS**
[0.9" HEIGHT]

MODEL# VR30T09



DESIGNED IN USA

**TACTICAL SERIES
30MM RINGS**
[1.1" HEIGHT]

MODEL# VR30T11



DESIGNED IN USA

**TACTICAL SERIES
30MM RINGS**
[1.3" HEIGHT]

MODEL# VR30T13



DESIGNED IN USA

**TACTICAL SERIES
30MM RINGS**
[1.5" HEIGHT]

MODEL# VR30T15

- 30mm scope tube diameter rings with removable 1" inserts.
- Mounts onto Weaver/ Picatinny/ MIL-STD 1913 type rails.
- Hexagon shape mounting nut, with holes for torquing with Allen key wrench.
- Black anodized aluminum construction

SPECIFICATIONS	VR30T09	VR30T11	VR30T13	VR30T15
OVERALL HEIGHT	1.8"	2.1"	2.2"	2.4"
OPTIC HEIGHT	0.9"	1.1"	1.3"	1.5"
NET WEIGHT	4.6 oz.	4.9 oz.	5.2 oz.	5.4 oz.
ATTACHES TO:	Picatinny			
MATERIAL	Aluminum			
FEATURE	1" Inserts			

US PATENT: D826360

RAIL COVERS & HAND STOPS



- Slot Covers install into individual slots for making handguards more comfortable
- Made from rubber material that is textured to provide a comfortable and sure grip surface.
- Heat resistant material will insulate the handguard from rapid sustained semi-auto fire.
- The Slot Covers come in a pack of 18 each.

SPECIFICATIONS

LENGTH	0.8"
HEIGHT	0.2"
DEPTH	0.6"

US PATENT: 9581412



DESIGNED IN USA

KPM HAND STOP

MODEL# VMKPMHS

- KPM Handstop has a modular base that allow the mounting onto any handguards with KeyMod™ slots, Picatinny rails, and M-LOK® slots.
- Ergonomic shape, suitable for many different gripping techniques.
- Textured surface to provide slip resistant grip.
- Reversible, can be mounted in either direction.
- Mounting tools, KeyMod feet, and M-LOK compatible T-nut included
- Black anodized aluminum construction.

SPECIFICATIONS

LENGTH	2.5"
HEIGHT	1.9"
NET WEIGHT	2.3 oz.

US PATENT PENDING



DESIGNED IN USA

KEYMOD® HAND STOP GRIP

MODEL# VMKMHS

- Designed to mount onto KeyMod™ handguards.
- Ergonomic shape, suitable for many different gripping techniques.
- Textured surface to provide slip resistant grip.
- Reversible, can be mounted in either direction.
- Mounts onto handguard via one KeyMod® foot. Hand stop covers 3 KeyMod™ slots.
- Black anodized aluminum construction
- Mounting tool included

SPECIFICATIONS

LENGTH	2.9"
HEIGHT	1.6"
NET WEIGHT	1.4 oz.



DESIGNED IN USA

M-LOK® HAND STOP GRIP

MODEL# VMMLHS

- Designed to mount onto M-LOK® handguards.
- Ergonomic shape, suitable for many different gripping techniques.
- Textured surface to provide slip resistant grip.
- Reversible, can be mounted in either direction.
- Mounts onto handguard via two M-LOK® compatible feet. Hand stop covers 1.5 M-LOK® slots.
- Black anodized aluminum construction.
- Mounting tool included

SPECIFICATIONS

LENGTH	2.35"
HEIGHT	1.5"
NET WEIGHT	1.55 oz.

US PATENT PENDING



* Vertical Grip Not designed for Pump Shotguns

**FOLDING VERTICAL GRIP
4 POSITIONS**

MODEL# AARFVG

- With a push of a button you can change the angle of the grip to 4 different Positions
- Mounts onto Weaver and Picatinny type rails
- Ergonomic design for comfortable and secure grip
- Polymer construction for a light weight addition to your rifle, but with solid strength and reliability

SPECIFICATIONS	
HEIGHT	4.6"
NET WEIGHT	4.6 oz.

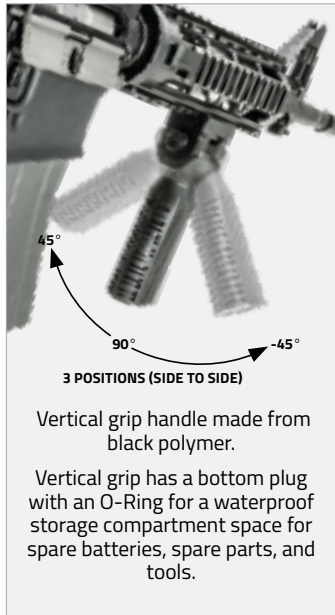

45°
90°
-45°
3 POSITIONS (SIDE TO SIDE)

Vertical grip handle made from black polymer.

Vertical grip has a bottom plug with an O-Ring for a waterproof storage compartment space for spare batteries, spare parts, and tools.

DESIGNED IN USA

**45° / 90° / - 45°
SIDE TO SIDE VERTICAL GRIP**

MODEL# VAAR45VG

- Innovative design: 45° / 90° / -45° Side to Side Vertical Grip
- With a push of a spring loaded button, the Vertical grip can be turned sideways 45° from vertical in either direction. Vertical Grip locks in place (3 positions).
- Improves the ergonomics. More comfortable grip when using Drum Magazines.
- Mounts onto Weaver/ Picatinny/ MIL-STD 1913 rails.
- Polymer & aluminum construction

SPECIFICATIONS	
HEIGHT	5.4"
NET WEIGHT	5.9 oz.

US PATENT: D749186



CONVERSION

Picatinny/ Mil-Std 1913 KeyMod™/ M-LOK®

After removal of the T-nut hardware and insert. The vertical grip mounts directly to most weaver, Picatinny, and Mil-Std 1913 rails via aluminum side clamp and bolt.

DESIGNED IN USA

KPM SHORT VERTICAL GRIP

MODEL# VAARSVGKPM

- Mounts to KeyMod™/ Picatinny/ Mil-Std 1913 / M-LOK® type rails
- Textured ergonomic grip
- Polymer construction

* Vertical grip NOT designed for pump shotguns

SPECIFICATIONS	
HEIGHT	3.1"
NET WEIGHT	2.9 oz.

US PATENT PENDING



**AR15
VERTICAL GRIP**

MODEL# AARH

- Mounts onto Weaver and Picatinny type rails
- Ergonomic design for comfortable and secure grip, rubber overmold grip area
- Black anodized aluminum construction

* Vertical grip NOT designed for pump shotguns

SPECIFICATIONS	
HEIGHT	4.6"
NET WEIGHT	7.1 oz.



**AR
VERTICAL GRIP**

MODEL# AARHP

- Mounts onto Weaver and Picatinny type rails
- Secured with large thumb screw
- Polymer construction

* Vertical grip NOT designed for pump shotguns

SPECIFICATIONS	
HEIGHT	4.5"
NET WEIGHT	3.1 oz.

GRIPS



DESIGNED IN USA

AR PISTOL GRIP

BLACK - MODEL# VAGPARB

TAN - MODEL# VAGPART

- Ergonomic design for comfortable and secure grip
- Storage compartment space for spare batteries, parts and tools
- Mounting screw included
- Polymer construction

SPECIFICATIONS

LENGTH	4.2"
NET WEIGHT	2.5 oz.

US PATENT D8215129



DESIGNED IN USA

AR FEATURELESS GRIP

MODEL# VAGPARCAM2

- Designed for firearms that use AR pistol grips for featureless builds.
- Ambidextrous Thumb rest feature for a secure grip
- Non-pistol grip design
- Storage compartment with door
- Mounting bolt included

SPECIFICATIONS

LENGTH	6.1"
NET WEIGHT	5.3 oz.

US PATENT PENDING

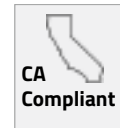

DESIGNED IN USA

AK FEATURELESS GRIP

MODEL# VAGPAKCA

- Designed for firearms that use AKM variant pistol grips for featureless builds.
- Thumb rest feature for a secure grip
- Non-pistol grip, right-handed design
- Trunnion and mounting bolt included

SPECIFICATIONS

LENGTH	6.1"
NET WEIGHT	5.5 oz.

US PATENT PENDING





**PRO SERIES
FLIP-UP SIGHTS**

DESIGNED IN USA

**PRO SERIES FLIP-UP
[REAR SIGHT]**

MODEL# VMARFLR

- Front spring actuator button automatically deploys rear sight. Simply push down to lock into place
- Low profile design folds flat and will fit under the majority of scopes available in the market
- The A2 dual aperture (large & small) rear sight is fully adjustable for windage
- Aluminum and steel construction

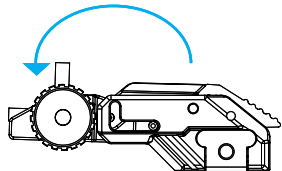

LOW PROFILE DESIGN

SPECIFICATIONS

FOLDED	2.5" L
HEIGHT	1.6"
NET WEIGHT	2.3 oz.

US PATENT: 9976834

DESIGNED IN USA

**PRO SERIES FLIP-UP
[FRONT SIGHT]**

MODEL# VMARFLF

- Front spring actuator button automatically deploys front sight. Simply push down to lock into place
- Front sight height is designed for Handguard rails, monolithic Receivers, and Gas Blocks that are at the same level as the AR15 receiver rails (flat top)
- A2 front sight post is fully adjustable for elevation
- Aluminum and steel construction

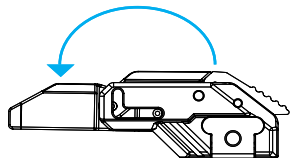

LOW PROFILE DESIGN

SPECIFICATIONS

FOLDED	2.5" L
HEIGHT	1.7"
NET WEIGHT	2.0 oz.

US PATENT: 9976834

DESIGNED IN USA

**PRO SERIES FLIP-UP
[FRONT AND REAR SIGHT SET]**

MODEL# VMARFLC

- Front spring actuator button automatically deploys front sight. Simply push down to lock into place
- Low profile design (front and rear sights)
- A2 front sight post is fully adjustable for elevation
- The A2 dual aperture (large & small) rear sight is fully adjustable for windage
- Aluminum and steel construction



SPECIFICATIONS

	VMARFLR	VMARFLF
FOLDED	2.5" L	2.5" L
HEIGHT	1.6"	1.7"
NET WEIGHT	2.3 oz.	2.0 oz.

US PATENT: 9976834

IRON SIGHTS



45° OFFSET FLIP-UP FRONT SIGHT

MODEL# MAR45FLF

- Fits onto receiver height Weaver, Picatinny, MIL-STD 1913 type rails
- The A2 front sight post is fully adjustable for elevation
- Front sight folds forward flat for a lower profile.
- Aluminum and steel construction

SPECIFICATIONS

LENGTH	1.1"
NET WEIGHT	2.1 oz.



45° OFFSET FLIP-UP REAR SIGHT

MODEL# MAR45FLR

- The A2 dual aperture (large & small) rear sight is fully adjustable for windage
- Rear sight folds back flat for a lower profile and will fit under the majority of scopes out in the market
- Aluminum and steel construction

SPECIFICATIONS

LENGTH	1.3"
NET WEIGHT	3.0 oz.



FLIP-UP SIGHT

MODEL# MARFLF

- Designed to be mounted on top of gas blocks with Picatinny rails lower than the AR15 receiver rail
- Flip-up A2 front sight post folds down out of view of your optics when not in use
- The A2 front sight post is fully adjustable for elevation
- Aluminum and steel construction

SPECIFICATIONS

FOLDED	1.2"
HEIGHT	2.1"
NET WEIGHT	2.6 oz.



FLIP-UP FRONT SIGHT - RECEIVER HEIGHT

MODEL# MARFLF2

- Front sight height is for handguard rails, monolithic Receivers, and gas blocks that are at the SAME Level as the AR15 receiver rails (Flat Top)
- Flip-up A2 front sight post folds down out of view of your optics when not in use
- The A2 front sight post is fully adjustable for elevation
- Aluminum and steel construction

SPECIFICATIONS

FOLDED	1.0"
HEIGHT	1.8"
NET WEIGHT	2.1 oz.



FLIP-UP REAR SIGHT

MODEL# MARFLR

- Mounts onto the AR15 flat-top receiver, directly onto the Picatinny rail
- The A2 dual aperture (large & small) rear sight is fully adjustable for windage, also with a large windage knob
- Rear sight folds back flat for a lower profile
- Aluminum and steel construction

SPECIFICATIONS

LENGTH	1.8"
NET WEIGHT	2.9 oz.

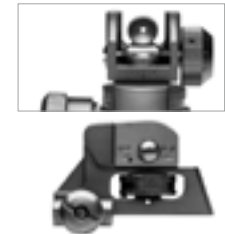

REAR A2 BACK UP IRON SIGHT

MODEL# MARDRS

- Precision made fixed A2 design adjustable for windage and elevation
- Mounts onto Weaver & Picatinny type rails
- Aluminum & steel construction

SPECIFICATIONS

LENGTH	2.8"
NET WEIGHT	5.2 oz.

SLING / BIPOD ADAPTERS



QUICK DETACHABLE 1.25" SLING SWIVEL

MODEL# AASWQRB

SPECIFICATIONS	
WIDTH	1.7"
NET WEIGHT	0.9 oz.

- Sling swivel quickly attaches and releases from QD mounts with a push of a button.
- Fits into standard QD mounts.
- Metal loop will accommodate 1.25" webbing.
- Black steel construction.
- Includes only one QD sling swivel in packaging.



DESIGNED IN USA

KEYMOD™ QD SLING MOUNT

MODEL# VMKMQSM

SPECIFICATIONS	
WIDTH	1.3"
NET WEIGHT	0.3 oz.

- KeyMod™ QD sling mount adapter for quick detachable slings and sling swivel mounts.
- KeyMod™ QD sling mount, designed to mount onto KeyMod™ handguards.
- Low profile design.
- Mounts onto handguard via two KeyMod™ feet.
- Mounting tool included



DESIGNED IN USA

KEYMOD™ SLING ATTACHMENT POINT

MODEL# VMKMSL

SPECIFICATIONS	
WIDTH	1.8"
NET WEIGHT	1.2 oz.

- Low profile KeyMod™ sling mount for use with virtually any clip style sling
- Attaches to KeyMod™ for a secure fit
- Constructed of steel with all mounting hardware included



1" LOCKABLE SLING SWIVELS

MODEL# AASW1B

SPECIFICATIONS	
WIDTH	1.6"
NET WEIGHT	0.8 oz.

- Mounts onto most standard sling studs found on most hunting rifles and shotguns.
- To unlock, unscrew the knurled thumb nut, push in and rotate side arm 90 degrees to open sling swivel mount. Place bar through sling stud on long gun, rotate side arm over bar and screw in the knurled thumb nut to lock the sling swivel mount.



Low Profile Design

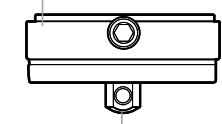

Sling Swivel Stud: Mounting point for NcSTAR® precision grade bipod

RAIL MOUNTED SLING SWIVEL STUD / BIPOD ADAPTER

MODEL# MWBM

- Mounts to most Weaver/ Picatinny MIL-STD 1913 type rails
- Provides sling swivel stud as a mounting point for slings or bipods that mount to swivel stud
- Black anodized aluminum construction

SPECIFICATIONS	
LENGTH	1.9"
NET WEIGHT	2.1 oz.



KEYMOD

DESIGNED IN USA

KEYMOD™ RAIL MOUNTED SLING SWIVEL STUD/ BIPOD ADAPTER

MODEL# VMKMBA

- Mounts onto 2 KeyMod™ slots
- Provides sling swivel stud as a mounting point for slings or bipods that mount to swivel stud
- Black anodized aluminum construction

SPECIFICATIONS	
WIDTH	2.4"
NET WEIGHT	1.2 oz.



M-LOK

DESIGNED IN USA

M-LOK™ RAIL MOUNTED SLING SWIVEL STUD/ BIPOD ADAPTER

MODEL# VMMLBA

- Mounts onto 2 M-LOK™ slots
- Provides sling swivel stud as a mounting point for slings or bipods that mount to swivel stud
- Black anodized aluminum construction

SPECIFICATIONS	
WIDTH	2.4"
NET WEIGHT	1.2 oz.

MUZZLE BRAKE

INCLUDES:

Adapter to switch from
74 to AK-47 threading

AK-



DESIGNED IN USA

AK47/AK74 MUZZLE BRAKE

MODEL# VAMAKT

- Very effective AKM/AK47/AK74 multi chamber muzzle brake that virtually eliminates all muzzle rise.
- Fits AK74 M24mm X 1.5 RH barrels with detent. Includes internal thread adapter for AKM/AK47 M14mm X 1 LH threaded barrels with detent.
- Designed for 7.62X39, 5.45X39, 5.56X45 (.223) calibers.
- Directs exiting Propellant Gasses upwards & to both sides, to control muzzle rise
- The lower portion of the brake is closed to reduce the dust signature when firing prone

SPECIFICATIONS

LENGTH	3.3"
NET WEIGHT	6.8 oz.
THREADS	M14mm X 1/ M24mm X 1.5
FINISH	BLACK
MATERIAL	Steel Construction



CRUSH WASHERS (3 PCS)

MODEL# AARCW

- This allows you to properly time your muzzle brakes and flash hiders on your barrel, so that the ports are facing the correct directions for optimum performance.
- Steel Construction with Black finish

SPECIFICATIONS

LENGTH	.01"
NET WEIGHT	0.1 oz.

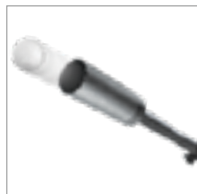

GOLF BALL LAUNCHER

MODEL# AGOLF

- Attaches to the muzzle of a AR15/ M4/ M16 and launches golf balls with 5.56 Blanks
- Tube is threaded for 1/2 x 28 barrels.
- Screws onto the end of AR15/ M4/ M16 barrel threads
- Uses 5.56 military blanks to launch golf balls.
DO NOT USE LIVE AMMO
- Launches golf balls to several hundred yards (**400+ YRDS**)
- Black steel construction

SPECIFICATIONS

LENGTH	1.0"
DIAMETER	1.9"
NET WEIGHT	20.0 oz.

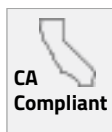

DESIGNED IN USA

BLASTAR THUMBHOLE STOCK

MODEL# VKARSTK

US PATENT: D855138

- AR thumbhole stock with internal storage compartment, and rubber butt pad
- Multiple points to install QD sling cups (cups not included)
- Pistol grip storage compartment with door
- Designed to only fit MIL-SPEC Carbine buffer tubes
- Constructed of polymer, and hard anodized aluminum.
- Mounting hardware included
- Includes thumbhole filler featureless plate, for those that want to configure stock as a featureless design, in restricted States.



DESIGNED IN USA

BLASTAR MAGWELL FUNNEL

MODEL# VKARMW

US PATENT: D855138

- The two piece magazine well funnel facilitates faster and smoother magazine changes.
- Magwell funnel fits over MIL-SPEC forged AR receivers.
- The mouth of the magwell funnel is beveled to help guide magazines into the magwell of the receiver.
- The magwell funnel is easily and quickly installed onto the receiver with three Allen head bolts.
- Constructed of hard anodized aluminum.
- Mounting bolts and tools included.

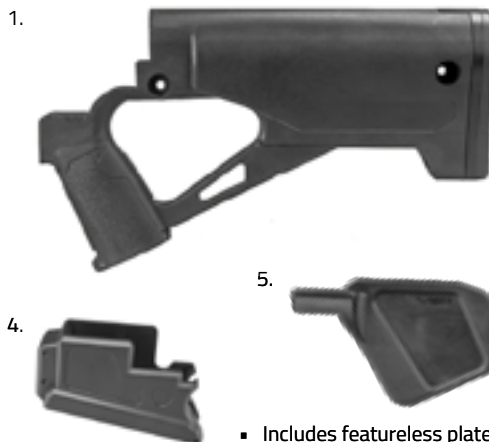
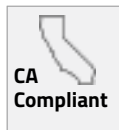

- Includes featureless plate

DESIGNED IN USA

BLASTAR KIT

MODEL# VKARB1

US PATENT: D855138

1. One piece thumbhole stock with internal storage, multiple points to mount QD cups, and a replaceable butt pad
 2. Forward carry handle wraps around the existing F-type front sight post with M-LOK® slots on the top, and incorporates a riser over the receiver
 3. Ergonomic carbine extended 2 piece triangular handguard features KeyMod™ mounting points
 4. Two piece mag well adapter for faster and smoother magazine changes
 5. Includes thumbhole filler featureless plate, for those that want to configure stock as a featureless design, in restricted States.
- All pieces constructed of polymer and/or hard anodized aluminum

CARRY HANDLES



DESIGNED IN USA

ADVANCED CARRY HANDLE COMBO

ADVANCED CARRY HANDLE + GREEN DOT OPTIC WITH INTEGRATED RED LASER

MODEL# VMDCHVDGRLB-A

- Dual locking quick release mount that attaches to picatinny rails
- There is a laser channel machined onto the top of the carry handle allowing the laser to pass through.
- In the front is an adjustable for windage back-up flip-up rear aperture iron sight set at the proper 1.5" AR15 sight height.
- Green dot reflex optic with integrated red laser is two sighting devices in a compact and sleek design.
- 3 MOA green dot has five brightness settings.
- Green dot reticle is fully adjustable for elevation & windage.
- Integrated red laser is fully adjustable for elevation & windage, independent from the green dot.
- The green dot and red laser are controlled by a single rheostat dial.
- Powered by a CR2032 battery (included)

SPECIFICATIONS	VDGRLB
MAGNIFICATION	1X
OBJECTIVE LENS DIAMETER	25 mm
DOT SIZE	3 MOA
FIELD OF VIEW (ft @ 100 yds)	98.3' - 27.2'
EYE RELIEF	3.7-3.3"
EXIT PUPIL	12.6-6.0 mm
WEIGHT (oz.)	10.9 oz
OVERALL LENGTH (in)	6.6"
CLICK VALUE @ 100 YDS	1/2 MOA
ILLUMINATION	Green
LENS COATING	Platinum
DIMENSIONS	6.6"L x 2.6"H x 2.0"D

US PATENT: D749185
US PATENT: 9372049



DESIGNED IN USA

MICRO GREEN DOT W/INTEGRATED RED LASER

MODEL# VDGRLB

US PATENT: D679775

See page 20



DESIGNED IN USA

DCH

ADVANCED CARRY HANDLE
AR15 GEN 2 QR CARRY HANDLE AND OPTIC MOUNT

MODEL# VMDCHMFRQ

SPECIFICATIONS	
LENGTH	6.3"
NET WEIGHT	6.8 oz.

US PAT.: D749185, 9372049

- Dual locking quick release mount that attaches to Picatinny rails
- Rear of mount has an optics rail for mounting a reflex optic.
- Pass-through laser sight channel (When mounted with VISM® VDGRLB / VDGRLT)
- Scope center line at 1.5" AR15 height (When mounted with VISM® VDGRLB / VDGRLT)
- All aluminum construction. Black anodized finish



DESIGNED IN USA

BLASTAR CARRY HANDLE MOUNT

MODEL# VKARCH

SPECIFICATIONS	
LENGTH	14.75"
NET WEIGHT	10.5 oz.

US PATENT: D855138

- The carry handle is designed to be mounted around the front sight post in a forward position over the handguard and the forward portion of the upper receiver. Leaving room behind the carry handle for most folding rear backup iron sight on the rear portion of the receiver rail.
- The carry handle can also be mounted onto any 14.5" length of Picatinny rail of any type of firearm.
- The carry handle features a 0.5" Picatinny rail riser for mounting optics.
- The Picatinny riser is 5.25" in length.
- Constructed of hard anodized aluminum.
- Mounting bolts and tools included



AR15/M16 DETACHABLE CARRY HANDLE

MODEL# MARDCH

SPECIFICATIONS	
LENGTH	6.9"
NET WEIGHT	8.9 oz.

- Classic A2 rear sight design (dual aperture) **ADJUSTS FOR ELEVATION AND WINDAGE**
- Mounts via two thumb nuts, **NO TOOLS REQUIRED FOR MOUNTING**
- Aluminum & steel construction



AMBIDEXTROUS THUMB
ACTIVATION PEDALS

PRESS DOWN:
Activate Momentary

PRESS UP:
Activate Constant ON

VGF

Vertical Grip Flashlight



PICATINNY

DESIGNED IN USA

VERTICAL GRIP FLASHLIGHT PICATINNY

MODEL# VAARVGFLPR

SPECIFICATIONS

LENGTH	7.5"
NET WEIGHT	10.1 oz.

US PATENT: D846057



M-LOK

DESIGNED IN USA

VERTICAL GRIP FLASHLIGHT M-LOK®

MODEL# VAARVGFLML

SPECIFICATIONS

LENGTH	8.3"
NET WEIGHT	9.9 oz.

US PATENT: D846057



KEYMOD

DESIGNED IN USA

VERTICAL GRIP FLASHLIGHT KEYMOD™

MODEL# VAARVGFLKM

SPECIFICATIONS

LENGTH	7.5"
NET WEIGHT	9.7 oz.

US PATENT: D846057

- Ultra Bright 3W | 250 Lumen CREE® LED flashlight with crenellated bezel and strobe feature
- Lightweight ergonomic textured grip
- Mechanical control buttons are completely ambidextrous
- Uses two CR123A lithium type batteries (Included)

BEZEL MOUNTED MODE SELECTOR RING:

● FULL POWER:
250 LUMENS

◐ HALF POWER:
150 LUMENS

⚡ STROBE:
250 LUMENS

FLASHLIGHTS

PRO SERIES

TACTICAL FLASHLIGHT

MOD. 2

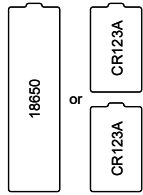

Removable Picatinny/
Weaver rail mount
INCLUDED

DESIGNED IN USA

PRO SERIES LED FLASHLIGHT WITH MOUNT RAIL

MODEL# VATFLBMM2

Pro Series Mod2 3W 500 Lumen Handheld Full Size Flashlight
Bezel mounted Mode Selector Ring. You can quickly switch between High / Low intensity / Strobe
Custom two-way steel pocket clip, can be clipped onto clothing in either direction / orientation
Push Button Rubber On/Off switch
Includes Picatinny/ MIL-STD 1913 rail mount
Black Anodized Aluminum Construction
Uses 2 CR123A Lithium Type Battery (Included)

Compatible: Rechargeable 8650 Lithium Ion battery with safety control circuit. (Not included)



RUBBER PUSH BUTTON

LIGHT PRESS:
Momentary On/Off
FULL PRESS:
Constant On/Off



TWO WAY STEEL POCKET CLIP

Can be clipped onto clothing in either direction/orientation.



CREE® LED

3 Watt bright CREE® LED, 500 Lumens max output. Powered by Two CR123A (incl.)



TWIST MODE SELECTOR:

HIGH: 500 Lumens
LOW: 250 Lumens
STROBE: 500 Lumens

TWIST MODE SELECTOR



SPECIFICATIONS

OUTPUT	3W 500 Lumens
LENGTH	5.2"
WEIGHT	6.1 oz.
BATTERY (included)	Two CR123A
FINISH	Black Anodized
MATERIAL	Aluminum
ATTACHES TO:	Weaver/Picatinny

US PATENT: D804696

PRO SERIES

HUNTING FLASHLIGHT



Removable Picatinny/
Weaver rail mount
INCLUDED

DESIGNED IN USA

HUNTING GREEN LED FLASHLIGHT

MODEL# VATFLBGM

Full size flashlight with high/ low Intensity and strobe features. **Green** LED flashlight output is designed to not spook some game animals at night, yet allows the user to see in the dark. Includes Weaver style/ Picatinny mount.

SPECIFICATIONS

OUTPUT	3W 250 Lumens
LENGTH	5.2"
WEIGHT	6.1 oz.
BATTERY (included)	Two CR123A
FINISH	Black Anodized
MATERIAL	Aluminum
ATTACHES TO:	Weaver/Picatinny

US PATENT: D804696

COMPACT FLASHLIGHT



DESIGNED IN USA

COMPACT LED FLASHLIGHT

MODEL# VATFLBC

Compact flashlight with high/ low Intensity and strobe features.
Custom two-way steel pocket clip, can be clipped onto clothing in either direction/ orientation.
Push Button Rubber On/Off switch.
Tailcap Body factory machined for a lanyard (not included).
Flashlight central body diameter is 0.83".
Black Anodized Aluminum Construction

SPECIFICATIONS

OUTPUT	3W 250 Lumens
LENGTH	3.9"
WEIGHT	3.1 oz.
BATTERY (included)	One CR123A
FINISH	Black Anodized
MATERIAL	Aluminum
ATTACHES TO:	Weaver/Picatinny

US PATENT: D804696

LONG GUN FLASHLIGHTS & HANDGUN FLASHLIGHTS



DESIGNED IN USA

FLASHLIGHT WITH STROBE FEATURE & FRONT SIGHT POST

MODEL# VAFLFSP

- Mounts onto Weaver, Picatinny, MIL-STD 1913
- Front sight is at 1.5" AR15 height and is adjustable elevation
- 3W ultra bright 200 Lumen CREE® LED flashlight
- Ambidextrous flashlight switch buttons controls momentary, constant On/Off and strobe
- Includes remote pressure switch
- Includes mounting tool

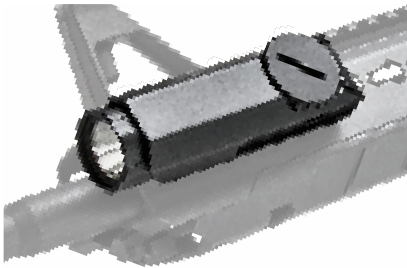

DESIGNED IN USA

FLASHLIGHT WITH KEYMOD™ MOUNT

MODEL# VAFLKM

- Toolless KeyMod™ flashlight that mounts onto any two KeyMod™ slots
- 3W ultra bright 200 Lumen CREE® LED flashlight
- Ergonomic multifunction flashlight switch button (rear side)
- Includes remote pressure switch



3W | 160 LUMENS LED FLASHLIGHT

MODEL# ATFLB

- Mounts onto most Weaver, and Picatinny rails
- 3W ultra bright 160 Lumen CREE® LED flashlight
- Momentary and constant On/Off cap switch

SPECIFICATIONS	VAFLKM	VAFLFSP	ATFLB
OUTPUT	3W 200 Lumens		3W 160 Lumens
LENGTH	4.0"	3.5"	4.6"
WEIGHT	5.0 oz.	4.6 oz.	5.7 oz.
BATTERY (included)	One CR123A		
FINISH	Black Anodized		
MATERIAL	Aluminum		
ATTACHES TO:	KeyMod™	Weaver/Picatinny / MIL-STD 1913 type rails	
PATENT	US D844734	US D808489	N/A



DESIGNED IN USA

FLASHLIGHT WITH STROBE FEATURE & WEAVER MOUNT

MODEL# VAPTF

- Mounts onto Weaver, Picatinny, MIL-STD 1913
- 3W Ultra Bright 200 Lumen CREE® LED flashlight
- Ambidextrous flashlight switch buttons controls momentary, constant On/Off and strobe
- Includes mounting tool

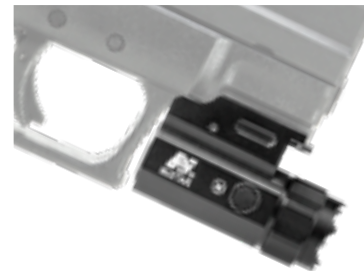

3W | 150 LUMENS LED COMPACT FLASHLIGHT WITH QR & STROBE FEATURE

MODEL# ACQPTF

- Quick release mounts onto most Weaver, and Picatinny rails
- 3W ultra bright 150 Lumen CREE® LED flashlight
- Push button on/off (left), and push button strobe (right) controls



3W 150 LUMENS LED FLASHLIGHT WITH QR & STROBE FEATURE

MODEL# AQPTF3

- Quick release mounts onto most Weaver, and Picatinny rails
- 3W ultra bright 150 Lumen CREE® LED flashlight
- Push button on/off (left), and push button strobe (right) controls

SPECIFICATIONS	AQPTF3	ACQPTF	VAPTF
OUTPUT	3W 150 Lumens		3W 200 Lumens
LENGTH	4.0"	3.5"	4.6"
WEIGHT	3.0 oz.	2.6 oz.	3.8 oz.
BATTERY (included)	One CR123A	One CR2	One CR123A
FINISH	Black Anodized		
MATERIAL	Aluminum		
ATTACHES TO:	Weaver/Picatinny / MIL-STD 1913 type rails		
PATENT	N/A	N/A	US D807981

BLUE LASERS

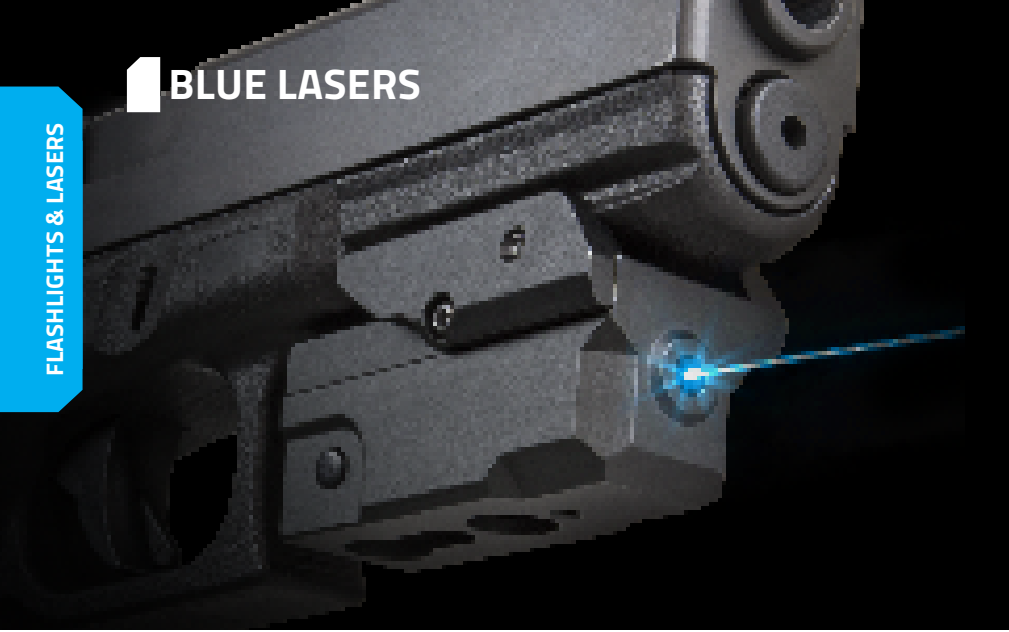

DESIGNED IN USA

PISTOL BLUE LASER WITH KEYMOD™ ACCESSORY BASE MOUNT

MODEL# VAPRLSBLKM

- Mounts onto most Weaver style / Picatinny / MIL-STD 1913/ pistol accessory rails
- Ambidextrous digital on/off buttons
- Press and hold on/off button to switch to strobe mode
- The laser features our Patented KeyMod™ undermount for future KeyMod™ accessories that can attach to the underside of the laser.



DESIGNED IN USA

COMPACT BLUE LASER WITH PICATINNY MOUNT

MODEL# VAPRLSMBLV2

- Compact blue laser with a Weaver/Picatinny type rail mount that will fit most Weaver/Picatinny/ MIL-STD 1913 type rails.
- Fully adjustable for windage and elevation. **INCLUDES:** Adjustment tool
- Push button rubber switches on both sides of laser body to turn laser On/Off.
- Approximately 30+ hours of battery life.



SPECIFICATIONS	VAPRLSBLKM	VAPRLSMBLV2
LASER CLASS		IIIa Blue
WAVE LENGTH		450nm
OUTPUT		<5mW
LENGTH	2.0"	2.0"
WEIGHT	2.0 oz.	1.8 oz.
BATTERY (included)		Two CR1/3N
FINISH		Black Anodized
MATERIAL		Aluminum
ATTACHES TO:	Weaver style / Picatinny / MIL-STD 1913/ pistol accessory rails	
PATENT	US 9506721	US 9506721 , D737399



DESIGNED IN USA

PISTOL GREEN LASER WITH STROBE FEATURE

MODEL# VAPT LG

- Mounts onto most Weaver / Picatinny / MIL-STD 1913/ Pistol accessory spec rails
- Electronic control buttons are completely Ambidextrous
- Fully adjustable for windage and elevation
- Includes mounting and adjustment tools



DESIGNED IN USA

COMPACT PISTOL GREEN LASER WITH STROBE FEATURE

MODEL# VAPRLSMCG

- Mounts onto most Weaver / Picatinny / MIL-STD 1913/ pistol accessory spec rails
- Fully adjustable for windage and elevation
- Ambidextrous laser switch buttons with strobe feature
- Includes mounting and adjustment tools



DESIGNED IN USA

AR15/M4 GREEN LASER WITH STROBE AND A2 IRON FRONT SIGHT POST

MODEL# VALGFSP

- Mounts onto Weaver/ Picatinny/ MIL-STD 1913 type rails.
- A2 front sight is fully adjustable for elevation
- Electronic control buttons are completely Ambidextrous
- Includes remote pressure switch
- Includes mounting and adjustment tools



DESIGNED IN USA

GREEN LASER WITH KEYMOD™ MOUNT

MODEL# VALGKM

- Toolless KeyMod™ Laser that mounts onto any two KeyMod™ slots
- Fully adjustable for windage and elevation
- Ergonomic multifunction laser switch button (rear side)
- Includes remote pressure switch
- Includes adjustment tools

SPECIFICATIONS	VAPT LG	VAPRLSMCG	VALGFSP	VALGKM
LASER CLASS			IIIa Green	
WAVE LENGTH			532nm	
OUTPUT			<5mW	
LENGTH	3.4"	2.0"	3.6"	4.1"
WEIGHT	4.1 oz.	1.8 oz.	4.8 oz.	4.8 oz.
BATTERY (included)	One CR123A	Two CR1/3 N	One CR123A	
FINISH	Black Anodized			
MATERIAL	Aluminum			
ATTACHES TO:	Weaver/Picatinny / MIL-STD 1913/ pistol accessory type rails		Weaver/Picatinny / MIL-STD 1913 type rails	KeyMod™
PATENT	US D807981	US D737399	US D808489	US 9423216

GREEN LASERS



GREEN LASER WITH WEAVER STYLE MOUNT

MODEL# APRLSG

- Weaver style mount will fit most Weaver & Picatinny type rails
- Fully adjustable for windage and elevation
- Momentary end cap switch
- Includes mounting, adjustment tools and remote pressure switch



COMPACT GREEN LASER WITH WEAVER MOUNT

MODEL# A2PRLSG

- Weaver style mount will fit most Weaver & Picatinny type rails
- Fully adjustable for windage and elevation
- Rubber push button On/Off switch
- Includes mounting and adjustment tools



COMPACT GREEN LASER WITH WEAVER STYLE MOUNT

MODEL# APRLSMG

- Weaver style mount will fit most Weaver & Picatinny type rails
- Fully adjustable for windage and elevation
- Momentary end cap switch
- Includes mounting, adjustment tools and remote pressure switch



COMPACT GREEN LASER WITH QR WEAVER MOUNT

MODEL# AQPTLMG

- Quick release Weaver style mount.
- Fully adjustable for windage and elevation
- Ambidextrous sliding On/Off switch
- Includes adjustment tool

SPECIFICATIONS	APRLSG	A2PRLSG	APRLSMG	AQPTLMG
LASER CLASS			IIIa Green	
WAVE LENGTH			532nm	
OUTPUT			<5mW (532nm)	
LENGTH	4.1"	3.3"	3.4"	2.6"
WEIGHT	5.2 oz.	2.9 oz.	3.8 oz.	3.3 oz.
BATTERY (included)	One CR123A			One CR2
FINISH	Black Anodized			
MATERIAL	Aluminum			
ATTACHES TO:	Weaver/Picatinny / MIL-STD 1913 type rails			Quick Release Weaver Style Mount



DESIGNED IN USA

KEYMOD™ QR COMPACT GREEN LASER

MODEL# VALGKMQR

- Patented auto-locking KeyMod™ quick release latch system locks the laser tightly to any KeyMod™ spec handguard
- Green laser features a strobe mode using the rear on/off control button
- Single multifunction rear button controls on/off and strobe mode
- Low profile design gets the laser as close as possible to the bore
- Body is constructed of polymer, while the KeyMod™ hardware is constructed of steel
- Uses two CR1/3N batteries (Included)



DESIGNED IN USA

PISTOL GREEN LASER WITH KEYMOD™ ACCESSORY BASE MOUNT

MODEL# VAPRLSGKM

- Mounts onto most Weaver style / Picatinny / MIL-STD 1913/ pistol accessory rails
- Fully adjustable green laser: 532nm, Max output <5mW, Class IIIa Laser
- Ambidextrous digital on/off buttons
- Press and hold on/off button to switch to strobe mode
- The laser features our Patented KeyMod™ undermount for future KeyMod™ accessories that can attach to the underside of the laser.
- Uses two CR1/3N batteries (Included)



DESIGNED IN USA

RED LASER WITH KEYMOD™ QR

MODEL# VALRKMQR

- Patented auto-locking KeyMod™ quick release latch system locks the laser tightly to any KeyMod™ spec handguard
- Red laser features a strobe mode using the rear on/off control button
- Single multifunction rear button controls on/off and strobe mode
- Low profile design gets the laser as close as possible to the bore
- Body is constructed of polymer, while the KeyMod™ hardware is constructed of steel
- Uses two CR1/3N batteries (Included)



DESIGNED IN USA

PISTOL RED LASER WITH KEYMOD™ ACCESSORY BASE MOUNT

MODEL# VAPRLSRKM

- Mounts onto most Weaver style / Picatinny / MIL-STD 1913/ pistol accessory rails
- Red Laser: Freq. (635-655nm), Class IIIa Laser Maximum Output:<5mW
- Ambidextrous digital on/off buttons
- Press and hold on/off button to switch to strobe mode
- The laser features our Patented KeyMod™ undermount for future KeyMod™ accessories that can attach to the underside of the laser.
- Uses two CR1/3N batteries (Included)

SPECIFICATIONS	VALGKMQR	VAPRLSGKM	VALRKMQR	VAPRLSRKM
LASER CLASS		IIIa Green		IIIa Red
WAVE LENGTH		(532nm)		(635-655nm)
OUTPUT		<5mW		<5mW
LENGTH	2.5"	2.0"	2.5"	2.5"
WEIGHT	1.4 oz.	2.0 oz.	1.4 oz.	2.0 oz.
BATTERY (included)	Two CR1/3N			
FINISH	Black Anodized			
MATERIAL	Aluminum			
ATTACHES TO:	KeyMod™	Weaver / Picatinny / MIL-STD 1913/ Pistol accessory spec rails	KeyMod™	Weaver / Picatinny / MIL-STD 1913/ Pistol accessory spec rails
PATENT	9341441	9506721 , D737399	9341441	9506721 , D737399

RED LASERS



RED LASER WITH TRIGGER MOUNT

MODEL# APLS

- Designed to fit on most pistol, rifle or shotgun metal trigger guards
- Fully adjustable for windage and elevation
- Side to side toggle On/Off end cap switch



DESIGNED IN USA

RED LASER WITH WEAVER MOUNT

MODEL# AAPRLS

- Weaver style mount will fit most Weaver & Picatinny type rails
- Fully adjustable for windage and elevation
- Side to side toggle On/Off switch



COMPACT RED LASER WITH WEAVER MOUNT

MODEL# ACPRLS

- Weaver Mount will easily clamp onto compact & subcompact pistols that have a weaver style accessory rail
- Fully adjustable for windage and elevation
- Side to side toggle On/Off end cap switch



RED LASER WITH TRIGGER MOUNT

MODEL# ATPLS

- Mounts onto most trigger guards, perfect for pistols that do not have an integrated accessory rail
- Fully adjustable for windage and elevation
- Side to side toggle On/Off Switch

SPECIFICATIONS	APLS	AAPRLS	ACPRLS	ATPLS
LASER CLASS	IIIa Red			
WAVE LENGTH	(635-655nm)			
OUTPUT	<5mW			
LENGTH	3.0"	2.3"	1.7"	2.7"
WEIGHT	1.0 oz.	1.7 oz.	1.3 oz.	1.0 oz.
BATTERY (included)	Three AG13	Two AG13	Two AG13	Two AG13
FINISH	Black Anodized			-
MATERIAL	Aluminum			Polymer
ATTACHES TO:	Trigger Guard	Weaver & Picatinny		Trigger Guard

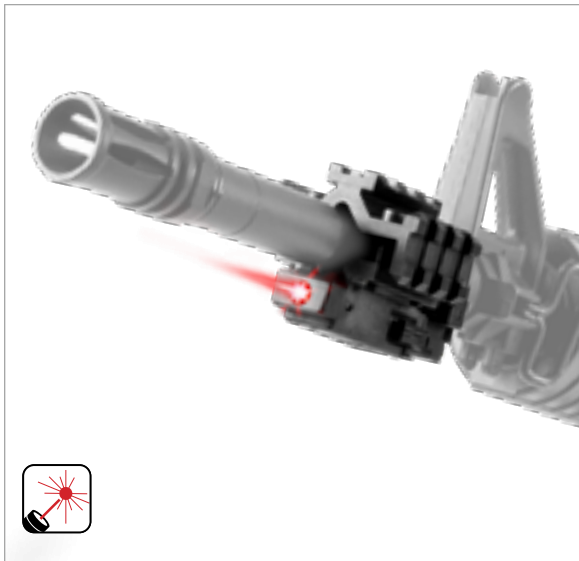

DESIGNED IN USA

**RED LASER WITH TRI-RAIL
UNIVERSAL RIFLE BARREL MOUNT**

MODEL# ATRLS

- Tri-rail designed to attach additional accessories
- Will fit most standard rifle barrel diameters
- Fully adjustable for windage and elevation
- Side to side toggle On/Off switch
- Includes mounting and adjustment tools

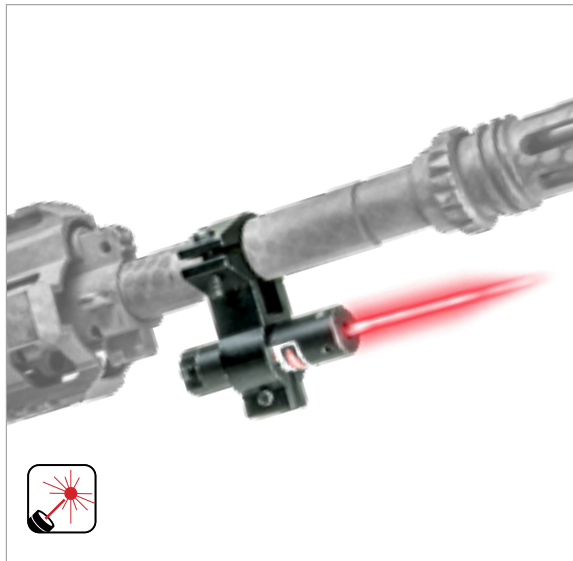

**RED LASER WITH
UNIVERSAL RIFLE BARREL MOUNT**

MODEL# ARLS

- Will fit most standard rifle barrel diameters
- Fully adjustable for windage and elevation
- Side to side toggle On/Off end cap switch
- Includes mounting and adjustment tools

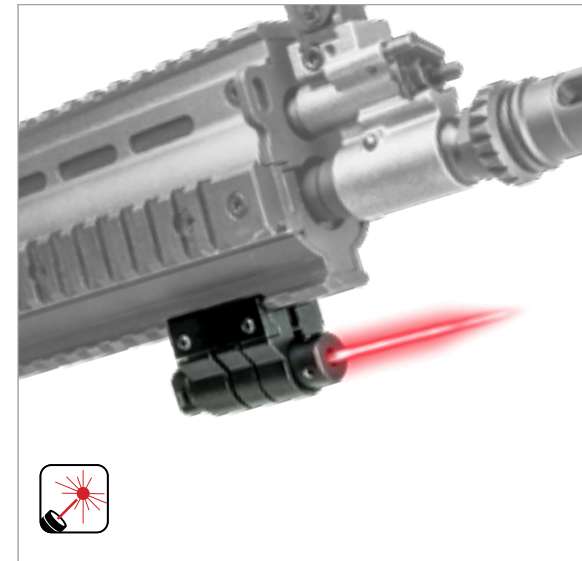

**RED LASER WITH
WEAVER MOUNT**

MODEL# APRLS

- Mounts to most Weaver style/Picatinny rails
- Fully adjustable for windage and elevation
- Side to side toggle On/Off end cap switch
- Includes mounting and adjustment tools

SPECIFICATIONS	ATRLS	ARLS	APRLS
LASER CLASS		IIIa Red	
WAVE LENGTH		(635-655nm)	
OUTPUT		<5mW	
LENGTH	2.4"	2.2"	2.7"
WEIGHT	2.8 oz.	1.9 oz.	2.0 oz.
BATTERY (included)	Two AG13	Three AG13	
FINISH		Black Anodized	
MATERIAL		Aluminum	
ATTACHES TO:	Standard Rifle Barrel Diameters		Weaver & Picatinny

FLASHLIGHTS & LASER COMBOS



Shown: AQPFLS

200L FLASHLIGHT & LASER WITH QUICK RELEASE MOUNT



INTERCHANGEABLE FLASHLIGHT & GREEN LASER

FLASHLIGHT + RED LASER

MODEL# AQPFLS



3W 200 lumen CREE® LED flashlight with crenellated bezel

RED LASER
635-655nm <5mW, CLASS IIIa fully adjustable red laser

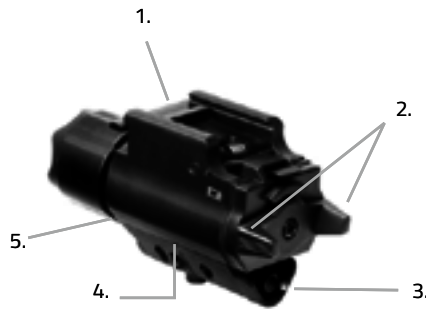

FEATURES

1. Mounts onto most Weaver / Picatinny / Pistol accessory spec rails
2. Ambidextrous momentary or constant-on switch
3. Rear selector mode switch: for laser only, flashlight only, or simultaneous
4. Aluminum and reinforced nylon construction
5. Uses two CR123A batteries (Included)

SPECIFICATIONS

LENGTH	3.5"
WEIGHT WITH BATTERY	4.2 oz.

FLASHLIGHT + GREEN LASER

MODEL# AQPFLSG



3W 200 lumen CREE® LED flashlight with crenellated bezel

GREEN LASER
532nm <5mW, CLASS IIIa fully adjustable green laser

INTERCHANGEABLE HEADS



FLASHLIGHT & GREEN LASER WITH QUICK RELEASE MOUNT

MODEL# AQPTFLG

- Locking quick release Weaver/ Picatinny type mount
- Shooter can quickly swap between the flashlight or green laser bezel
- Mounts onto most Weaver/ Picatinny/pistol accessory spec rails
- Uses one CR123A battery (included)

3W 200 lumen CREE® LED flashlight

GREEN LASER
532nm <5mW, CLASS IIIa fully adjustable green laser

SPECIFICATIONS

LENGTH	3.2"
WEIGHT + FLASHLIGHT	3.6 oz.
WEIGHT + GREEN LASER	3.8 oz.



Shown:
TOP: VAPFLSRV3
BOTTOM: VAPFLSGV3

FLASHLIGHT & LASER COMBOS

PISTOL FLASHLIGHT WITH STROBE & LASER

FLASHLIGHTS & LASERS



DESIGNED IN USA

FLASHLIGHT + RED LASER

MODEL # VAPFLSRV3



3W 200 lumen
CREE® LED flashlight



RED LASER
635-655nm <5mW, CLASS IIIa
fully adjustable red laser



DESIGNED IN USA

FLASHLIGHT + GREEN LASER

MODEL # VAPFLSGV3



3W 200 lumen
CREE® LED flashlight



GREEN LASER
532nm <5mW, CLASS IIIa
fully adjustable green laser

- Mounts onto most Weaver/ Picatinny/pistol accessory spec rails
- Ambidextrous momentary or constant-on switch
- Lasers are fully adjustable for windage and elevation
- Aluminum and reinforced nylon construction
- One CR123A battery (included)

FUNCTIONS

FLASHLIGHT

- 1. STROBE FEATURE**
On/Off
- 2. MOMENTARY**
On/Off
- 3. CONSTANT**
On/Off

LASER

- 4. LASER CONSTANT**
On/Off

SPECIFICATIONS

LENGTH	3.4"
WEIGHT WITH BATTERY	4.0 oz.

US PATENT D807981

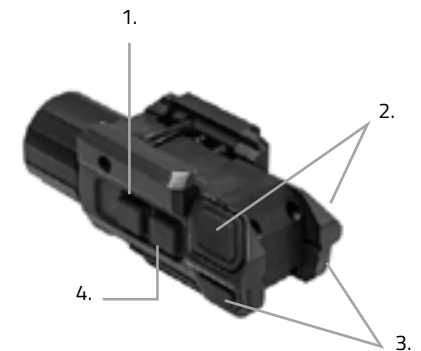

FLASHLIGHT & LASER COMBOS

VERTICAL GRIP WITH STROBE FLASHLIGHT & GREEN LASER

Ultra Bright 3W 200 Lumen CREE® LED vertical foregrip with integrated laser. Dual buttons allow easy selection between constant or momentary use. Selector allows user to choose white light, white light and laser, or laser only. Quick release mount allows for fast mounting and dismounting.

Shown: VAQVGFLGV2



DESIGNED IN USA

FLASHLIGHT + RED LASER

MODEL# VAQVGFLRV2

 3W 200 lumen CREE® LED flashlight with crenellated bezel

 **RED LASER**
635-655nm <5mW, CLASS IIIa fully adjustable red laser



DESIGNED IN USA

FLASHLIGHT + GREEN LASER

MODEL# VAQVGFLGV2

 3W 200 lumen CREE® LED flashlight with crenellated bezel

 **GREEN LASER**
532nm <5mW, CLASS IIIa fully adjustable green laser

- Fully Adjustable (Windage & Elevation) Laser.
- Locking Quick Release Mount, compatible with Weaver/Picatinny type rails.
- Uses two CR123A batteries (included)

SPECIFICATIONS

LENGTH	3.3"
HEIGHT	6.0"
WEIGHT	10.0 oz.

US PATENT: D704298

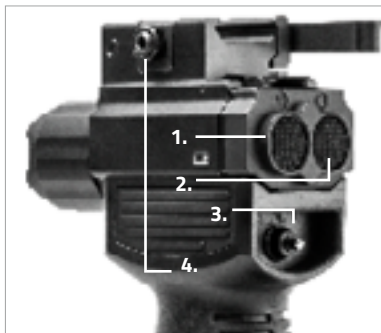

1. Momentary On Push button
2. Constant On/Off Push button
3. 3 Way Toggle: Flashlight only, laser only, and simultaneous mode
4. Locking quick release mount compatible with Weaver/Picatinny type rails

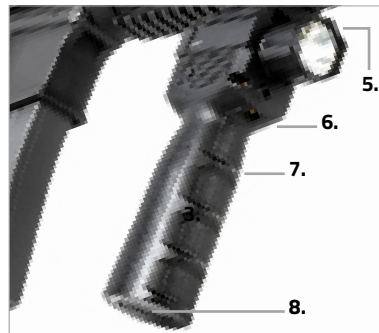

5. Ultra bright 3W 200 Lumens Cree® LED Flashlight with crenellated bezel
6. Fully Adjustable (windage & elevation) laser
7. Lightweight glass reinforced nylon ergonomically textured grip
8. Waterproof internal storage inside handle



FEATURES: STROBE LIGHT MODE

FOR TACTICAL APPLICATIONS OR SIGNALING,

Police tacticians have long recognized the blinding caused by placing the hotspot of a high-intensity light in a subject's eyes.





L2

LASER & LIGHT BOX

DESIGNED IN USA

GREEN LASER & 4 COLOR NAV LED W/QR MOUNT

MODEL# VLG4NVQRB

- Right pod is 4 color LED NAV lights in white, red, green, and blue
- Micro dot base on top of the designator box for mounting an optional NcSTAR® micro dot: (will require an optional micro dot spacer for the mechanical On/Off switch.)
- Includes a two position remote pressure switch. The 3.5 mini jack plugs in to the rear jack port of the Designator box.
- Locking quick release mount fits: Weaver/ Picatinny/ MIL-STD 1913 type rails
- Uses a single CR123A lithium type battery (Included)
- Includes: remote pressure switch, battery, and adjustment tools.

ELECTRONIC CONTROL PANEL

- 1. NAV LIGHT:**
Color Rotary Switch
- 2. NAV LIGHT CONSTANT:** On/Off
- 3. GREEN LASER CONSTANT:** On/Off
- 4. GREEN LASER MOMENTARY:** On
- 5. NAV LIGHT MOMENTARY:** On



GREEN LASER
532nm <5mW, CLASS IIIa fully adjustable green laser



4 COLOR LED NAV LIGHTS:
White, Red, Green, and Blue LED

SPECIFICATIONS	
LENGTH	3.2"
WEIGHT WITH BATTERY	6.3 oz.

US PATENT: D747432

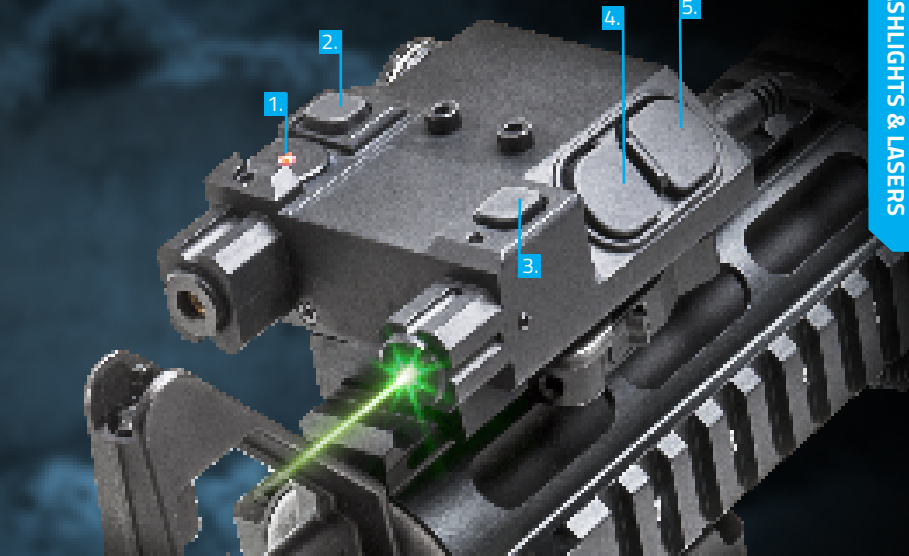

L2 IR

DESIGNED IN USA

GREEN & IR LASER DESIGNATOR W/QR MOUNT

MODEL# VLGIRQRB

- Right pod is a IR laser and left pod is a green laser, both fully adjustable for windage and elevation
- Micro dot base on top of the designator box for mounting an optional NcSTAR® micro dots
- Includes a two position remote pressure switch. The 3.5 mini jack plugs into the rear jack port of the designator box.
- Locking quick release mount fits: Weaver/ Picatinny/ MIL-STD 1913 type rails
- Uses a single CR123A lithium type battery (Included)
- Includes: remote pressure switch, battery, and adjustment tools.

ELECTRONIC CONTROL PANEL

- 1. IR INDICATOR LIGHT**
- 2. IR LASER CONSTANT:** On/Off
- 3. GREEN LASER CONSTANT:** On/Off
- 4. GREEN LASER MOMENTARY:** On
- 5. IR LASER MOMENTARY:** On



INFRARED LASER
850 nm, Max Output <5mW CLASS I Laser



GREEN LASER
532nm <5mW, CLASS IIIa fully adjustable green laser

SPECIFICATIONS	
LENGTH	3.2"
WEIGHT WITH BATTERY	6.6 oz.

US PATENT: D747432

*IR LASER ONLY VISIBLE WITH NIGHT VISION COMPATIBLE EQUIPMENT

LASER DESIGNATORS

DESIGNED IN USA

OFF-SET GREEN LASER DESIGNATOR & 2 COLOR NAV LIGHTS WITH QR MOUNT

MODEL# VLGSNVQRB

FEATURES

1. Green laser
2. 2 Color navigation LED lights: White / Red
3. Uses one CR123A battery (Included)
4. Locking quick release mount
5. Remote mini-jack dual mode pressure switch (included)



GREEN LASER

532nm <5mW, CLASS IIIa
fully adjustable green laser



2 COLOR LED NAV LIGHTS:

White and Red



SPECIFICATIONS

LENGTH	2.8"
WEIGHT WITH BATTERY	5.8 oz.

US PATENTS: D815239

ELECTRONIC CONTROL PANEL

- NAV light: color toggle
- Nav light constant: On/Off
- Green laser constant: On/Off



- Nav light momentary: On
- Green laser momentary: On

DESIGNED IN USA

GREEN AND RED LASER BOX WITH RAIL MOUNT

MODEL# APXLRGB

- Red and green laser each have their own separate elevation and windage adjustments.
- Lasers can be activated by side button or from the remote pressure switch.
- Mode switch on the side will switch between the red and green laser color and a third mode that will activate both red & green lasers at the same time.
- Includes a remote pressure switch with a 3.5mm mini jack that plugs into the side jack port of the designator box.
- Mount fits: Weaver/ Picatinny/ MIL-STD 1913 type rails.
- Uses a single CR2 lithium type battery (Included)
- Includes: remote pressure switch and adjustment tools.



FULLY ADJUSTABLE RED LASER

635-655nm, <5mW, Class IIIa



FULLY ADJUSTABLE GREEN LASER

532nm, <5mW, Class IIIa

SPECIFICATIONS

LENGTH	2.5"
WEIGHT WITH BATTERY	4.5 oz.

US PATENTS: D749689



KPM BIPOD

DESIGNED IN USA

KPM BIPOD

MODEL# VBKPM

US PATENT: 15708105

- Bipod kit incorporates three different mounting adapters in Picatinny, KeyMod™, and M-LOK®
- The feet can be used in two different modes: standard rubber feet for hard flat surfaces, and spiked feet for gravel & dirt surfaces
- Integrated spiked feet are spring loaded and automatically retract when not in use
- Spring loaded adjustable legs for quick deployment
- Notched legs are adjustable for height from 11.0 inches to 8.5 inches
- Constructed of hard anodized aluminum and steel

KPM SIDE BIPOD

KPM BIPODS

NEW DESIGNED IN USA

KPM SIDE BIPOD

MODEL# VBSKPM

- Bipod has two separate bipod legs that can be mounted to either side of a handguard
- Modular mounting system that includes all the hardware and tools for mounting the KPM Bipod to KeyMod™ slots, Picatinny rails, and M-LOK® slots
- Spring loaded notched bipod legs allow you to quickly deploy the bipod legs at many different lengths
- Spring loaded steel talons can be deployed onto loose soil and vegetation for more traction
- Rubber bipod feet also provide traction on hard and smooth surfaces
- Aluminum and steel construction

KPM MOUNTS

KeyMod™ Mount



Picatinny Mount Locking Quick Release



M-LOK® Mount



RUBBER FEET



CLAW FEET



LOCKING NOTCHED LEGS:

- The spring ejects the leg fully
- Push the lever to adjust 6 different lengths

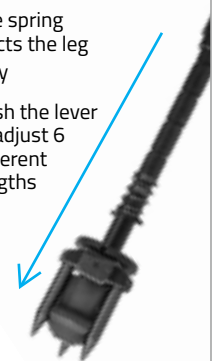

DISCLAIMER: KPM Mounts not used with Side Bipod

PRECISION GRADE & STANDARD BIPODS

BIPODS



BIPOD WITH QR WEAVER MOUNT & NOTCHED LEGS

MODEL# ABUQNL

- Includes universal barrel mount

AR15 QR BAYONET LUG BIPOD WITH NOTCHED LEGS

MODEL# ABABNL

- Attaches to most AR15 bayonet lugs



PRECISION GRADE BIPOD (COMPACT) - FRICTION LOCK LEGS

MODEL# ABPGC

- Spring loaded folding action
- Steel and aluminum construction
- Rubber pod feet for stability

PRECISION GRADE BIPOD (COMPACT) - NOTCHED LEGS

MODEL# ABPGC2



PRECISION GRADE BIPOD (FULL SIZE) - FRICTION LOCK LEGS

MODEL# ABPGF

- Spring loaded folding action
- Steel and aluminum construction
- Rubber pod feet for stability

PRECISION GRADE BIPOD (FULL SIZE) - NOTCHED LEGS

MODEL# ABPGF2

ABUQNL | ABABNL

FEATURE LOCKING NOTCHED LEGS:

- The spring ejects the leg fully
- Push the lever to adjust 6 different lengths

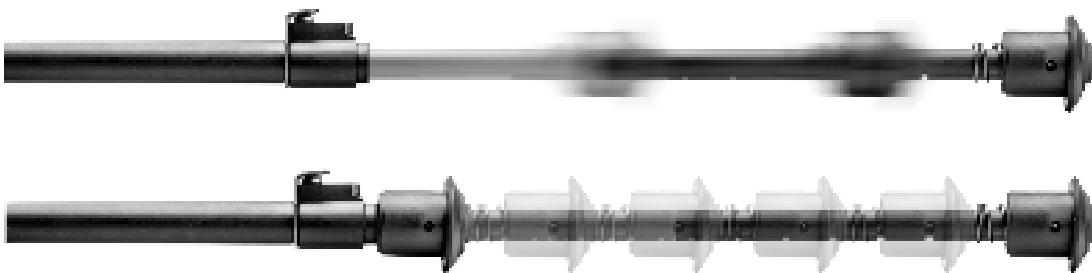

ABPGC | ABPGC2 | ABPGF | ABPGF2

INCLUDES: 3 Separate Adapters

- AR15 GI handguard adapter
- Universal rifle barrel mount
- Weaver/ Picatinny type rail with sling stud



VISM[®]
A DIVISION OF NcSTAR

P E R F O R M A N C E G E A R



BALLISTIC PLATE AND PANELS

SOFT BALLISTIC PANEL

RATED LEVEL IIIA Capable of stopping 9mm and .44 Mag rounds up to 1,400 FPS

- Flexible design allows the panel to conform to various shapes ideal for use in plate carriers, backpacks, laptop cases, and luggage.



BALLISTIC PANEL [SOFT]
Shooter's Cut
10" X 12" - MODEL# BSC1012
11" X 14" - MODEL# BSC1114



BALLISTIC PANEL [SOFT]
Rectangle Cut
8" X 10" - MODEL# BSF810
10" X 12" - MODEL# BSF1012
11" X 14" - MODEL# BSF1114



BALLISTIC PANEL [SOFT]
Side Panels
6" x 6" - MODEL# BSS66



BALLISTIC PANEL [SOFT]
Side Panels
6" x 8" - MODEL# BSS68



BALLISTIC PANEL [SOFT]
Side Panels
6" x 11" - MODEL# BSS611

HARD BALLISTIC PLATE

RATED LEVEL III PLUS Capable of stopping 7.62x51mm (M80) rounds

- Curved design fits the user with greater comfort, and the cut upper corners (shooter's Cut) allows for better mobility
- Ideal for use in VISM® Plate Carriers



PE BALLISTIC PLATE [HARD]
Shooter's Cut
10" X 12" - MODEL# BPC1012
11" X 14" - MODEL# BPC1114



PE BALLISTIC PLATE [HARD]
Rectangle Cut
11" X 14" - MODEL# BPF1114



PE BALLISTIC PLATE [HARD]
Side Panel - Curved
6" X 6" - MODEL# BPSD66C



PE BALLISTIC PLATE [HARD]
Side Panel
6" X 6" -MODEL# BPSD66

CERAMIC/PE COMPOSITE PLATE

RATED LEVEL IV Capable of stopping .30 caliber AP and M2 rounds

CERAMIC & PE BALLISTIC PLATE

Shooter's Cut
10" X 12" - MODEL# B4C1012
11" X 14" - MODEL# B4C1114

- Ballistic plate is constructed of a Ceramic/ UHMWPE composite resulting in lighter plate
- Material structure allows for a greater crack resistance over other ceramic plate designs
- Rated at level IV- capable of stopping .30 caliber AP and M2 rounds with a bullet weight of 166 grains
- Curved design fits the user with greater comfort , and the cut upper corners allow for better mobility
- Fully sealed to protect against liquids, chemicals, and other harsh elements
- Ideal for use in VISM® Plate Carriers



CERAMIC & PE BALLISTIC PLATE
Square Plate - Curved
6" X 6" - MODEL# B4C66C



Constructed of Ultra High Molecular Weight Polyethylene (UHMWPE) creating a light weight ballistic plate. Fully sealed to protect against liquids, chemicals, and other harsh elements. Ideal for use in VISM® Plate Carriers and VISM® Backpacks.

BALLISTIC PLATE AND PANELS

UHMWPE HARD BALLISTIC PLATE

RATED LEVEL IIIA+ Capable of stopping 9mm and .44 Mag rounds up to 1,400 FPS



The added UHMWPE layers provide additional Level IIIA+ protections against these following SPECIAL THREATS cartridges:

- 9mm, 115 gr. FMJ - Fiocchi
- 9mm, 127 gr. +P+ SXT
- .40-cal., 95 gr. HP S&W
- 5.7 X 28mm, 27 gr. LFHP SS195
- 5.7 X 28mm, 28 gr. HP SS192
- 5.7 X 28mm, 40 gr. V-MAX SS197SR - Hornady
- 7.62 X 25mm, 95 gr. FMJ - Tokarev
- .357 SIG, 115 gr. JHP
- .357 cal., 125 gr. HP SIG Gold Dot
- .357 cal., 125 gr. FMJ SIG - FN

UHMWPE BALLISTIC PLATE

Multi-Curve Shooter's Cut

10" X 12" - MODEL# BUDPCM1012

- Made with UHMWPE fabrics and pressed with a proprietary technique to create a lighter plate, tested in accordance with Level IIIA Standard 0101.06.
- Multi-Curved design fits the user with greater comfort and the angle cut upper corners allow for better mobility.
- Durable Polyurea sprayed on outer coating protects and fully seals the UHMWPE plate for: corrosion protection, structural enhancement, waterproof, abrasion resistance, and for a nice cosmetic appearance.
- Also protects against knives, edged blades, and spike weapons that offers the wearer the best possible stab protection available.
- Ideal for use in VISM® Plate Carriers

SRT SiC CERAMIC/PE COMPOSITE PLATE

RATED LEVEL III+ Designed to defeat Level III+ threats from high velocity rifle rounds from the most commonly used rifle threats in use



SRT SiC CERAMIC & PE BALLISTIC PLATE

Shooter's Cut

10" X 12" - MODEL# BP3PC1012

11" X 14" - MODEL# BP3PC1114

SRT SiC CERAMIC & PE BALLISTIC PLATE

Square Plate - Curved

6" X 6" - MODEL# BP3P66C

- Level III+ SRT SiC Ceramic/PE Composite Plate.
- Special Rifle Threat (SRT) is designed to defeat Level III+ threats from high velocity rifle rounds from the most commonly used rifle threats in use.
- Ballistic plate constructed of a SiC Ceramic/UHMWPE composite resulting in a lighter plate.
- Material structure allows for a greater crack resistance over other ceramic plate designs.
- Curved design fits the user with greater comfort, and the cut upper corners allow for better mobility.
- Fully sealed to protect against liquids, chemicals, and other harsh elements.
- Ideal for use in VISM® plate carriers.

NIJ CERTIFIED BALLISTIC PLATE

RATED LEVEL III Capable of stopping U.S. Military 7.62 X 51 M80 is what it's tested and certified to stop. 147 gr FMJ bullet at 2780 ft/s.

NIJ PE BALLISTIC PLATE

Shooter's Cut

10" X 12" - MODEL# BNIJPC1012

- NIJ Certified Level III 10X12 Ballistic Plate has been certified under NIJ-0101.06.
- Composite construction with a primary front layer of Ultra High Molecular Weight Polyethylene (UHMWPE), a middle layer of molecular polymer padding infused with Microban®, and a rear layer of UHMWPE.
- Single curve design provides a contouring comfortable fit, with upper corners cut (shooter's cut) for maximum mobility.
- The plate is also fully sealed to protect against liquids, chemicals, and other harsh elements.
- Each plate weighs 3.5 lbs.

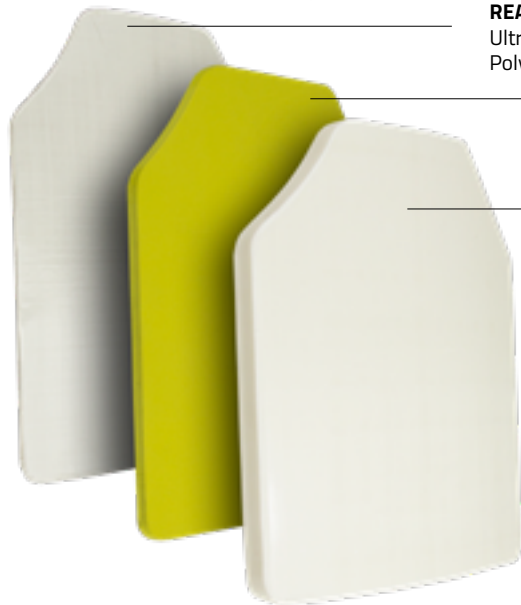

REAR LAYER [UHMWPE]
Ultra High Molecular Weight Polyethylene

MIDDLE LAYER
Molecular polymer padding infused with Microban®

FRONT LAYER [UHMWPE]
Ultra High Molecular Weight Polyethylene

Assembled in the USA.
Covered by our
10 year warranty.

BALLISTIC PLATE AND PANELS

UHMWPE | LEVEL IIIA

HARD BALLISTIC PLATE

PISTOL CALIBER & KNIFE PROTECTION

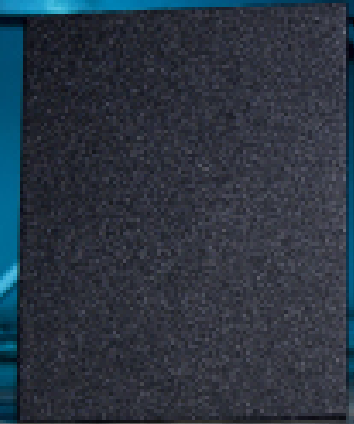

UHMWPE BALLISTIC PLATE
[HARD]

Shooter's Cut

10" X 12" - MODEL# BUDC1012

11" X 14" - MODEL# BUDC1114

UHMWPE BALLISTIC PLATE
[HARD]

Rectangle Cut

11" X 14" - MODEL# BUDF1114

10" X 12" - MODEL# BUDF1012

UHMWPE HARD BALLISTIC PLATE

RATED LEVEL IIIA Capable of stopping 9mm and .44 Mag rounds up to 1,400 FPS

- Made with UHMWPE fabrics and pressed with a proprietary technique to create lighter plate, tested in accordance with Level IIIA Standard 0101.06.
- Shooter's Cut curved design fits the user with greater comfort and the angle cut upper corners allow for better mobility.
- Durable Polyurea sprayed on outer coating protects and fully seals the UHMWPE plate for: corrosion protection, structural enhancement, waterproof, abrasion resistance, and for a nice cosmetic appearance.
- Also protects against knives, edged blades, and spike weapons that offers the wearer the best possible stab protection available.
- Ideal for use in VISM® Plate Carriers

- Made with UHMWPE (polyethylene).
- The ballistic shields are manufactured using a special pressing technique to create a lighter ballistic shield.
- Rugged, reliable, stress fracture resistant, and maintenance free.
- Durable wearing hard edge protection.



12"H X 24"W BALLISTIC SHIELD

MODEL# BPSHLD1224L3
Ballistic shield is rated for **NIJ LEVEL III**
MODEL# BPSHLD1224L3A
Ballistic shield is rated for **NIJ LEVEL IIIA**

- Flat rectangle design for rigidity and maximum protection.
- Grab handle with rubber grip can be used for left or right-handed carry use, hook and loop strap for forearm support, and padded forearm backrest provide standoff protection against ballistic impact backface deformation.

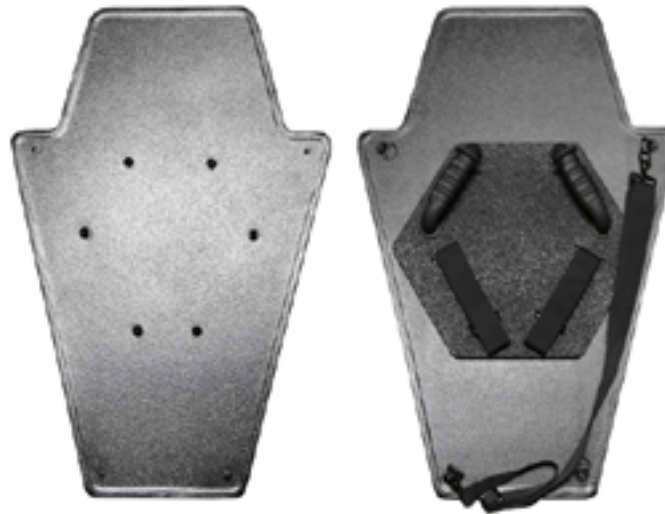

20"H X 30"W BALLISTIC SHIELD

MODEL# BPSHLD2030L3
Ballistic shield is rated for **NIJ LEVEL III**
MODEL# BPSHLD2030L3A
Ballistic shield is rated for **NIJ LEVEL IIIA**

- Ballistic shield is in a human trapezoid silhouette shape.
- Two angled grab handles with rubber grips for left or right-handed carry use, two hook and loop straps for forearm support, and padded forearm backrests provide standoff protection against ballistic impact backface deformation.
- Includes an adjustable shoulder strap for easier hands free carrying option.

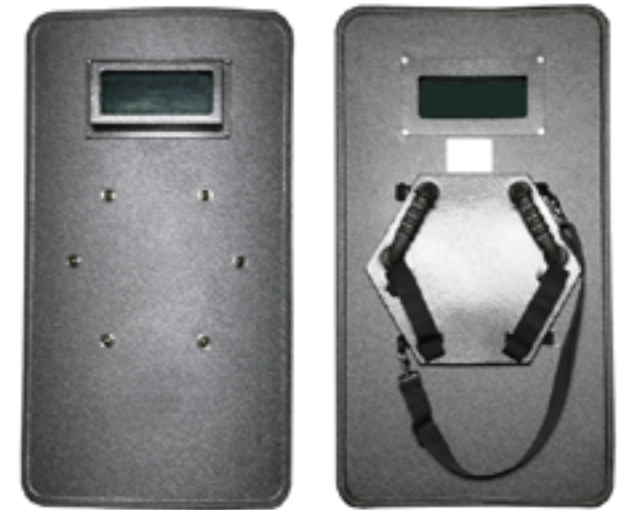

20"H X 36"W BALLISTIC SHIELD WITH WINDOW

MODEL# BPSHLD2036L3
Ballistic shield is rated for **NIJ LEVEL III**
MODEL# BPSHLD2036L3A
Ballistic shield is rated for **NIJ LEVEL IIIA**

- Viewing window is made with 1.75" thick high-performance bulletproof glass.
- Curved rectangle design for rigidity and maximum protection against angle shots.
- Two angled grab handles with rubber grips for left or right-handed carry use, two hook and loop straps for forearm support, and padded forearm backrests provide standoff protection against ballistic impact backface deformation.
- Includes an adjustable shoulder strap for easier hands free carrying option

PLATE CARRIER BALLISTIC COMBOS



Made with tough and durable 1050 Nylon material with double and re-enforcement cross stitching in critical areas.

FAST PLATE CARRIER WITH LEVEL IIIA

COLORS	SIZES	
	Soft Panel (Med-2XL) 10" x 12"	Soft Panel (XL-3XL) 11" x 14"
Black	BSCVPCF2995B-A	BSLCVPFL2995B-A
Green	BSCVPCF2995G-A	BSLCVPFL2995G-A
Tan	BSCVPCF2995T-A	BSLCVPFL2995T-A

SOFT BALLISTIC PANEL RATED LEVEL IIIA

Capable of stopping 9mm and .44 Mag rounds up to 1,400 FPS

- Accommodate a pair shooter's cut soft panels.
- Breathable mesh inner pockets on both the front and rear panels for body armor plates.
- Adjustable for length 2" side straps with large quick connect plastic buckles that can be extended out to 62"L.
- The quick connect buckles allow you to quickly and easily get the Fast plate carrier onto your body.
- PALS webbing on the front & back panels allows the attachments of MOLLE accessories

FAST PLATE CARRIER WITH LEVEL III+ PE

COLORS	SIZES	
	Hard Panel (SM-2XL) 10" x 12"	Hard Panel (XL-3XL) 11" x 14"
Black	BPCVPCF2995B-A	BPLCVPFL2995B-A
Green	BPCVPCF2995G-A	BPLCVPFL2995G-A
Tan	BPCVPCF2995T-A	BPLCVPFL2995T-A

HARD BALLISTIC PLATE RATED LEVEL III PLUS

Capable of stopping 7.62x51mm (M80) rounds

- Accommodate a pair shooter's cut hard ballistic plates.
- Breathable mesh inner pockets on both the front and rear panels for body armor panels.
- Adjustable for length 2" side straps with large quick connect plastic buckles that can be extended out to 62"L.
- The quick connect buckles allow you to quickly and easily get the Fast plate carrier onto your body.
- PALS webbing on the front & back panels allows the attachments of MOLLE accessories



Made with tough and durable 1050 Nylon material with double and re-enforcement cross stitching in critical areas.



PLATE CARRIER BALLISTIC COMBOS



FAST PLATE CARRIER COMBO

COLORS	SIZES	
	Hard Plate (Med-2XL) 10" x 12"	Hard Plate (XL-3XL) 11" x 14"
Black	BUCCVPCF2995B-A	BUCLCVPCFL2995B-A
Green	BUCCVPCF2995G-A	BUCLCVPCFL2995G-A
Tan	BUCCVPCF2995T-A	BUCLCVPCFL2995T-A

Made with tough and durable 1050 Nylon material with double and re-enforcement cross stitching in critical areas.



2924 PLATE CARRIER COMBO

COLORS	SIZES	
	Hard Plate (Med-2XL) 10" x 12"	
Black	BUCCVPCV2924B-A	
Green	BUCCVPCV2924G-A	
Tan	BUCCVPCV2924T-A	
Urban Gray	BUCCVPCV2924U-A	
Digital Camo	BUCCVPCV2924D-A	

UHMWPE HARD BALLISTIC PLATE RATED LEVEL IIIA

Capable of stopping 9mm and .44 Mag rounds up to 1,400 FPS

- Includes two hard ballistic plates
- Durable drag strap on back
- Fully adjustable shoulder straps with removable shoulder pads with PALS webbing

Fast Plate Carrier - Additional Information on Page 91
Plate Carrier - Additional Information on Page 90
Expert Plate Carrier - Additional Information on Page 91

BALLISTIC PLATE:

Constructed of Ultra High Molecular Weight Polyethylene (UHMWPE) creating a light weight ballistic plate Fully sealed to protect against liquids, chemicals, and other harsh elements. Curved design fits the user with greater comfort, and the cut upper corners allow for better mobility.

**UHMWPE 10"X12' SHOOTER'S CUT
LEVEL IIIA**
 ALLOWS FOR GREATER ARM MOVEMENT
 AND COMFORT



EXPERT PLATE CARRIER COMBO

COLORS	SIZES	
	Hard Plate (Med-2XL) 10" x 12"	
Black	BUCCVPCVX2963B-A	
Green	BUCCVPCVX2963G-A	
Tan	BPCVPCVX2963T-A	
Urban Gray	BUCCVPCVX2963U-A	
Red	BUCCVPCVX2963R-A	

PLATE CARRIER BALLISTIC COMBOS

SOFT BALLISTIC PANEL

RATED LEVEL IIIA

Capable of stopping 9mm and .44 Mag rounds up to 1,400 FPS

- Includes two soft ballistic panels
- Durable drag strap on back
- Fully adjustable shoulder straps with removable shoulder pads with PALS webbing

Plate Carrier - Additional Information on Page 90

Quick Release Plate Carrier - Additional Information on Page 92

Expert Plate Carrier - Additional Information on Page 91

BALLISTIC PANELS:

Constructed of Ultra High Molecular Weight Polyethylene (UHMWPE) creating a light weight ballistic panel. Fully sealed to protect against liquids, chemicals, and other harsh elements.

SHOOTER'S CUT
ALLOWS FOR GREATER ARM
MOVEMENT AND COMFORT



PLATE CARRIER COMBO

COLORS		SIZES
		Soft Panel (Med-XL) 10" x 12"
	Black	BSCVPCV2924B-A
	Green	BSCVPCV2924G-A
	Tan	BSCVPCV2924T-A
	Urban Gray	BSCVPCV2924U-A
	Digital Camo	BSCVPCV2924D-A

QUICK RELEASE PLATE CARRIER COMBO

COLORS		SIZES	
		Soft Panel (Med-XL) 10" x 12"	Soft Panel (Med-XL) 11" x 14"
	Black	BSCVPCVQR2964B-A	BSLCPCVQR2964B-A
	Green	BSCVPCVQR2964G-A	BSLCPCVQR2964G-A
	Tan	BSCVPCVQR2964T-A	BSLCPCVQR2964T-A

EXPERT PLATE CARRIER COMBO

COLORS		SIZES			
		Soft Panel (Med-XL) 8" x 10"	Soft Panel (Med-XL) 10" x 12"	Soft Panel (Med-XL) 11" x 14"	Soft Panel (2XL+) 10" x 12"
	Black	BSCVPCVXC2963B-A	BSCVPCVX2963B-A	BSLCPCVX2963B-A	BSCVPCVXL2963B-A
	Green	BSCVPCVXC2963G-A	BSCVPCVX2963G-A	BSLCPCVX2963G-A	BSCVPCVXL2963G-A
	Tan	BSCVPCVXC2963T-A	BSCVPCVX2963T-A	BSLCPCVX2963T-A	BSCVPCVXL2963T-A
	Urban Gray	-	BSCVPCVX2963U-A	BSLCPCVX2963U-A	-
	Red	-	BSCVPCVX2963R-A	BSLCPCVX2963R-A	-

PLATE CARRIER BALLISTIC COMBOS



HARD BALLISTIC PLATE RATED LEVEL III PLUS

Capable of stopping 7.62x51mm (M80) rounds

- Includes two hard ballistic plates
- Durable drag strap on back
- Fully adjustable shoulder straps with removable shoulder pads with PALS webbing

Plate Carrier - Additional Information on Page 90

Quick Release Plate Carrier - Additional Information on Page 92

Expert Plate Carrier - Additional Information on Page 91

BALLISTIC PLATE:

Constructed of Ultra High Molecular Weight Polyethylene (UHMWPE) creating a light weight ballistic plate Fully sealed to protect against liquids, chemicals, and other harsh elements. Curved design fits the user with greater comfort, and the cut upper corners allow for better mobility.

SHOOTER'S CUT

ALLOWS FOR GREATER ARM MOVEMENT AND COMFORT



QUICK RELEASE PLATE CARRIER COMBO

COLORS	SIZES	
	Hard Plate (Med-XL) 10" x 12"	Hard Plate (Med-XL) 11" x 14"
Black	BPCVPCVQR2964B-A	BPLCVPCVQR2964B-A
Green	BPCVPCVQR2964G-A	BPLCVPCVQR2964G-A
Tan	BPCVPCVQR2964T-A	BPLCVPCVQR2964T-A

PLATE CARRIER COMBO

COLORS	SIZES
	Hard Plate (Med-XL) 10" x 12"
Black	BPCVPCV2924B-A
Green	BPCVPCV2924G-A
Tan	BPCVPCV2924T-A
Urban Gray	BPCVPCV2924U-A
Digital Camo	BPCVPCV2924D-A

EXPERT PLATE CARRIER COMBO

COLORS	SIZES			
	Hard Plate (Med-XL) 10" x 12"	Hard Plate (2XL+) 10" x 12"	Hard Plate (Med-XL) 11" x 14"	Hard Plate (2XL+) 11" x 14"
Black	BPCVPCVX2963B-A	BPCVPCVXL2963B-A	BPLCVPCVX2963B-A	BPLCVPCVXL2963B-A
Green	BPCVPCVX2963G-A	BPCVPCVXL2963G-A	BPLCVPCVX2963G-A	BPLCVPCVXL2963G-A
Tan	BPCVPCVX2963T-A	BPCVPCVXL2963T-A	BPLCVPCVX2963T-A	BPLCVPCVXL2963T-A
Urban Gray	BPCVPCVX2963U-A	BPCVPCVXL2963U-A	BPLCVPCVX2963U-A	BPLCVPCVXL2963U-A
Red	BPCVPCVX2963R-A	-	BPLCVPCVX2963R-A	-

BACKPACK BALLISTIC COMBOS

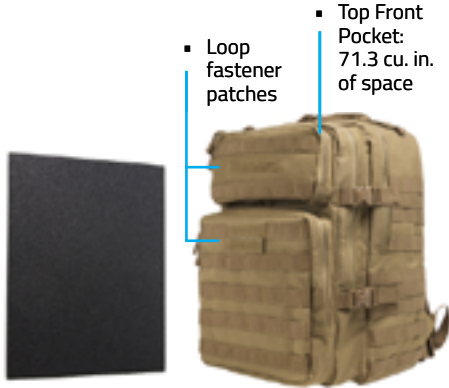

- Includes one each UHMWPE Ballistic Plate - Level IIIA (pistol caliber protection) Flat Rectangular Cut 11"X14". Tested in accordance with Level IIIA Standard 0101.06, capable of stopping 9mm and .44 Mag rounds up to 1,400 FPS. No rifle ammunition protection.

ASSAULT BACKPACK W/11"X14" LEVEL IIIA HARD BALLISTIC PLATE	
COLORS	SIZE
	(20.0"H x 13.0"W x 13.0"D)
Black	BUFLCBAB2974-A
Green	BUFLCBAG2974-A
Tan	BUFLCBAT2974-A
Urban Gray	BUFLCBAU2974-A
Digital Camo	BUFLCBAD2974-A



Middle compartment 18" H x 12" W x 2.5" D (540 sq inches). With a large mesh internal zippered compartment, 3 pockets, and two pen pockets.



Hydration bladder compatible, with drink tube routing onto either of the padded shoulder straps.

- Ballistic plate is made with UHMWPE fabrics that is pressed with a proprietary technique to create lighter plate. Durable Polyurea sprayed on outer coating protects and fully seals the UHMWPE plate for: Corrosion Protection, Structural enhancement, Waterproof, Abrasion Resistance, and for a nice Cosmetic appearance.
- Multiple compartments and MOLLE webbing to organize and customize your backpack to your needs. With over 2,200 sq inches of storage capacity.
- Main compartment dimensions: 18" H x 12" W x 6.5" D (1,404 sq inches). With Hydration compatible compartment, two large pockets, zippered compartment, and two smaller pockets.
- Top Outside Compartment: 5" H x 10.25" W x 1.25" D (64 sq inches), 1"H X 5"W loop fastener for attaching Name Tape. With two internal pockets.
- MOLLE compatible webbing on the front & bottom pockets, shoulder straps, and the sides of the backpack.
- Durable PVC construction that is chemical and water resistant.
- Adjustable sternum and waist straps with quick connect buckles



TACTICAL BACKPACK WITH 10"X12" LEVEL III+ SHOOTER'S CUT PE HARD BALLISTIC PLATE	
COLORS	SIZE
	(18.0"H x 12.0"W x 6.0"D)
Black	BPCBB2911-A
Green	BPCBG2911-A
Tan	BPCBT2911-A

- Main compartment dimensions: 18" H x 12" W x 6" D (1,200 sq inches)
- 4X Side compartments, two on each side: 5" H x 5" W x 1½" D,
- Top Outside Compartment: Top 4½" H x 8" W x 2" D
- Bottom 9½" H x 9½" W x 3" D
- MOLLE compatible webbing on the front pockets and the bottom of the backpack. Heavy Duty: Zippers, Carry Handles on the Top and both Sides of the backpack. Adjustable Compression Straps on the Sides of the backpack
- Includes one each: Level III+ 10"X12" Shooters Cut Ballistic Hard Plate that fits in a back pocket perfectly.
- Constructed of Ultra High Molecular Weight Polyethylene (UHMWPE) creating a light weight ballistic plate
- Rated at Level III Plus - capable of stopping 7.62x51mm NATO rounds.

BACKPACK BALLISTIC COMBOS

BALLISTIC COMBOS

SOFT PANELS:
Flexible design allows the panel to conform to various shapes.



SOFT PANELS:
Flexible design allows the panel to conform to various shapes.



TACTICAL BACKPACK COMBO

COLORS	SIZE
	(18.0"H x 12.0"W x 6.0"D)
Black	BSCBB2911-A
Green	BSCBG2911-A
Tan	BSCBT2911-A
Urban Gray	BSCBU2911-A
Blue w/ Black Trim	BSCBL2911-A
Black w/ Pink Trim	BSCBPK2911-A
Black w/ Purple Trim	BSCBPR2911-A
Pink Camo	BSCBPC2911-A
Red w/ Black Trim	BSCBR2911-A
Green w/ Tan Trim	BSCBGT2911-A
Tan w/ Urban Gray Trim	BSCBTU2911-A
Woodland Camo	BSCBWC2911-A
Digital Camo	BSCBD2911-A

[SOFT PANEL]
RATED LEVEL IIIA
Capable of stopping 9mm and .44 Mag rounds up to 1,400 FPS

+ THE PERFECT SIZE TO CARRY 3 DAYS OF ESSENTIAL GEAR

- Includes one Ballistic Soft Panel- Rectangle Cut 10"X12" that fits in the back pocket perfectly.
- 7 compartments
- Side handles
- MOLLE compatible webbing on the front pockets and the bottom of the backpack.

SOFT BALLISTIC PANELS:

Constructed of Ultra High Molecular Weight Polyethylene (UHMWPE) creating a light weight ballistic panel. Fully sealed to protect against liquids, chemicals, and other harsh elements.

ASSAULT BACKPACK WITH 11"X14" LEVEL IIIA SOFT BALLISTIC PANEL

COLORS	SIZE
	(20.0"H x 13.0"W x 13.0"D)
Black	BSCBAB2974-A
Green	BSCBAG2974-A
Tan	BSCBAT2974-A
Urban Gray	BSCBAU2974-A
Digital Camo	BSCBAD2974-A

[SOFT PANEL]
RATED LEVEL IIIA
Capable of stopping 9mm and .44 Mag rounds up to 1,400 FPS

+ THE PERFECT SIZE TO CARRY 3 DAYS OF ESSENTIAL GEAR

- Includes one Ballistic Soft Panel- Rectangle Cut 11"X14" that fits in the back pocket perfectly.
- Multiple compartments
- Over 2,200 sq inches of storage capacity
- MOLLE compatible webbing on the front pockets and the bottom of the backpack.

CCW LAPTOP BRIEFCASE WITH 10"X12" LEVEL IIIA SOFT BALLISTIC PANEL

COLORS	SIZE
	(14.5"L X 11.0"W X 3.0"D)
Black	BSFCVLTBC3024B-A

- Includes one Ballistic Soft Panel- Rectangle Cut 10"X12" that fits in the inside pocket perfectly.
- Multiple compartments
- Ambidextrous holster with hook and loop system (included)



CCW LAPTOP BRIEFCASE
MODEL# CVLTBC3024B
See page 105

BACKPACKS BALLISTIC COMBOS



GUARDIANPACK™

US PATENT: 10,130,160

- The GuardianPack™ incorporates two Level IIIA ballistic soft panels.
- The rear panel is a fixed 10"X12" full-size ballistic panel to protect your back torso.
- The Front vest panel is a rapid deployable 10"X12" shooters cut ballistic panel that protects your front torso.
- In less than 2 seconds you are protected both front and back from pistol caliber threats.
- All of the straps are fully adjustable for a custom fit.

	GuardianPack™	Backpack Model 3003 without body armor
COLORS	SIZE (17.5"H x 13.0"W x 8.5"D)	
Black	BGBPS3003B-A	BGBPS3003B
Light Gray	BGBPS3003LG-A	BGBPS3003LG
Navy	BGBPS3003N-A	BGBPS3003N



PULL AND > PROTECT

Two pull straps open a magnetic flap that deploys the front vest panel from its hidden compartment. Pulling the straps over your head deploys the front vest ballistic panel and then you can buckle the straps together around the waist to secure it.

The perfect Day backpack for work, school, the gym, and for other recreational activities.



Adjustable shoulder straps with thick padding for comfort.

DAY BACKPACK WITH 10"X12" SOFT PANEL BLACK

COLORS	SIZE
	(16.5"H X 12.0"W X 5.25"D)
Black	BSCBDPB2979-A

Day backpack has several compartments to carry and organize all your essential gear. The Day backpack has two main large zippered compartments, and three outside zippered compartments.



Side mesh pocket with elastic top for holding a water bottle

Two hydration hose pass through grommets with hook and loop flaps.

Many of the compartments have internal dividers, smaller pockets, and a hook for securing your keys



- 5 compartments
- Heavy duty zippers with metal pull tabs.
- Heavy duty carry strap mounted on top.
- Hydration bladder compatible
- Made from Nylon material
- Level IIIA Ballistic Soft Panel Rectangle Cut 10"X12" (BSF1012)

BALLISTIC HELMETS

BALLISTIC HELMETS

**PAD SYSTEM:
SWEAT-WICKING
MATERIAL**



BALLISTIC HELMET		
COLORS	SIZES	
	LARGE	X-LARGE
 Black	BPHLB	BPHXLB
 Green	BPHLG	BPHXLG
 Tan	BPHLT	BPHXLT



▪ **INCLUDES:
COMPACT
BALLISTIC HELMET
BAG**

- Ballistic shell constructed of Kevlar
 - Rated at Level IIIA : Capable of stopping 9mm and 44 Mag rounds up to 1,400 FPS
 - Four-point retention system and suspension system for added comfort and stability
 - Fully adjustable for the perfect fit
 - Includes ballistic helmet carry bag, with carry straps, shoulder strap, ID holder, MOLLE straps.
- **LARGE**
22" - 22.8" (56 cm x 58 cm)
51.1 oz. (1.45 kg)
- **X-LARGE**
22.8" - 23.6" (58 cm x 60 cm)
54.6 oz. (1.55 kg)



▪ **BLACK**



▪ **GREEN**



▪ **TAN**



▪ **HELMET NOT INCLUDED**

RIOT & TACTICAL HELMET BAG	
COLORS	SIZE
	(12.0"L x14.0"W x 9.0"D)
 Black	CLHELBAG2981B
 Green	CLHELBAG2981G
 Tan	CLHELBAG2981T

- This padded bag will accommodate a riot helmet with face shield, gas mask, spare filters, and a baton.
- Deep 9.5" compartment with a 2.5" lid, with 4 webbing straps to secure the helmet with hook loop fasteners.
- PALS webbing sewn to the exterior to attach MOLLE compatible gear to the outside of the bag.
- Carry straps, adjustable shoulder strap with spring loaded clasps, three web straps on the lid for attaching a baton, ID pocket, and a 1.5" X 6" loop fastener for name/unit patch.
- 10" X 7" mesh pocket on the inside of the lid for small items or for storing a spare CS/CN gas filter.
- Heavy duty zipper that is lockable. Small padlock is not included.







▪ **HELMET NOT INCLUDED**

COMPACT BALLISTIC HELMET BAG	
COLORS	SIZE
	(10.8"L x 10.0"W x 6.0"D)
 Black	CVHELBAG2992B

- Fully padded to protect your ballistic helmet.
- Top opening flap with dual zippers for getting to your ballistic helmet quickly.
- Heavy duty carry straps and an adjustable shoulder strap.
- Two MOLLE straps with metal button snaps for securing to PALS compatible gear.

VEST & CHEST RIGS









PLATE CARRIER WITH EXTERNAL POCKETS			
COLORS		SIZES	
		MED -2XL	2XL +
	Black	CVPCVEP2984B	CVPCVEPL2984B
	Green	CVPCVEP2984G	CVPCVEPL2984G
	Tan	CVPCVEP2984T	CVPCVEPL2984T
	Urban Gray	CVPCVEP2984U	-

- Breathable mesh inner pockets for soft body armor panels.
- Easy to access external hard body plate armor pockets with heavy duty zipper and a top flap with hook and loop fasteners.
- Will accommodate a pair of 10"X12" or 11"X14" hard plates.
- Adjustable quick connect buckles allow you to quickly and easily get the plate carrier onto your body.
- PALS webbing on the front & back panels allows the attachments of MOLLE accessories
- Made of durable PVC material that is water and chemical resistant. Double reinforced cross stitching in critical areas.

BACK SIDE>



DISCREET PLATE CARRIER				
COLORS		SIZES		
		XSML-SMALL	MED -2XL	2XL +
	Black	CVPCVDC2975B	CVPCVD2975B	CVPCVDXL2975B
	Green	CVPCVDC2975G	CVPCVD2975G	CVPCVDXL2975G
	Tan	CVPCVDC2975T	CVPCVD2975T	CVPCVDXL2975T
	Urban Gray	CVPCVDC2975U	CVPCVD2975U	CVPCVDXL2975U
	White	-	CVPCVD2975WH	-
	Navy	-	CVPCVD2975N	CVPCVDXL2975N <small>NEW</small>

- Discreet Plate Carrier with external pocket for soft body armor. Wrap around hook and loop fastener cummerbund and adjustable shoulder straps.
- Front panel measures 13.5"W X 13.5"H (from bottom of neck cut). Rear panel measures 16.5"W X 14.75"H (from bottom of neck cut).
- Exterior body armor pockets will accommodate up to 8.5"W X 11"H soft armor panels.
- Maximum cummerbund extension fit is 40"
- Adjustable hook and loop fastener 1.5" shoulder straps. For adjusting how high/low the plate carrier sits on the torso.
- 1.5"H X 7"L Loop fasteners sewn to the front and rear panels for name, unit, or moral patches.

VEST & CHEST RIGS

- Heavy duty drag handle on the top of the rear panel.



FAST PLATE CARRIER

COLORS	SIZES	
	PLATE SIZE: 10"X12"	PLATE SIZE: 11"X14"
Black	CVPCF2995B	CVPCFL2995B
Green	CVPCF2995G	CVPCFL2995G
Tan	CVPCF2995T	CVPCFL2995T

- Will accommodate a pair shooter's cut hard ballistic plates or soft panels.
- Breathable mesh inner pockets on both the front and rear panels for body armor plates/panels.
- Adjustable for length 2" side straps with large quick connect plastic buckles that can be extended out to 62"L.
- The quick connect buckles allow you to quickly and easily get the Fast plate carrier onto your body.
- PALS webbing on the front & back panels allows the attachments of MOLLE accessories
- Made with tough and durable 1050 Nylon material with double and re-enforcement cross stitching in critical areas.



1. Heavy duty drag handle on the top of the rear panel
2. Breathable mesh inner panels with separate internal pockets for soft body armor panels and hard plate armor.
3. Side pockets of the cummerbund will allow for 6"x 11" side armor panels/plates (MED - 2XL+)
4. PALS webbing and loop fastener patch for name and unit tape

EXPERT PLATE CARRIER

COLORS	SIZES		
	XSML-SMALL	MED -2XL	2XL +
Black	CVPCVXC2963B	CVPCVX2963B	CVPCVXL2963B
Green	CVPCVXC2963G	CVPCVX2963G	CVPCVXL2963G
Tan	CVPCVXC2963T	CVPCVX2963T	CVPCVXL2963T
Urban Gray	-	CVPCVX2963U	CVPCVXL2963U
Red	-	CVPCVX2963R	-

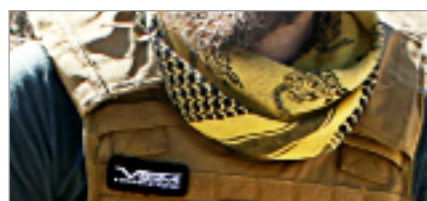

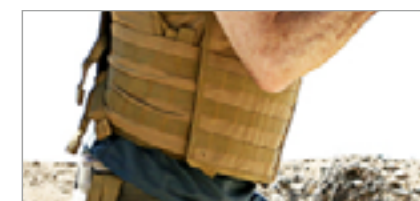

Includes two padded shoulder covers with PALS webbing, hook & loop fasteners, and loops for communications cable routing.



Cummerbund is adjustable for length, with PALS webbing, can be extended out to 51"L

VEST & CHEST RIGS



QUICK RELEASE PLATE CARRIER		
COLORS		
	Black	CVPCVQR2964B
	Green	CVPCVQR2964G
	Tan	CVPCVQR2964T

- Two padded shoulder covers with MOLLE webbing, hook & Loop fasteners, and loops for communications cable routing.
- Heavy duty drag handle on the top of the rear panel
- QR heavy duty plate carrier designed to fit large front & back armor plates up to 11" x 14" in size.
- Cummerbund is adjustable for length, with MOLLE webbing, can be extended out to 51"L
- MOLLE with hook & loop for name tape

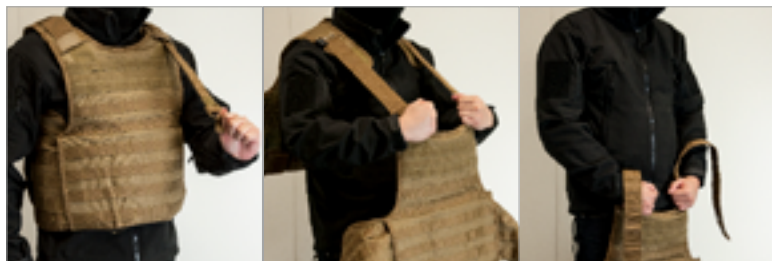



QUICK RELEASE > PULL STRAP Quick release pull strap will allow the plate carrier to separate into 4 separate panel pieces in case of an emergency that requires quick removal.



BACK
SIDE>



CONCEALED CARRIER VEST W/TWO LEVEL IIIA BALLISTIC PANELS

COLORS	SIZES					
	SMALL	MED	LARGE	XL	2XL	3XL
 Black	BSI3AVBS	BSI3AVBM	BSI3AVBL	BSI3AVBXL	BSI3AVB2XL	BSI3AVB3XL
 White	BSI3AVWS	BSI3AVWM	BSI3AVWL	BSI3AVWXL	BSI3AVW2XL	BSI3AVW3XL

- Front and back panels have internal compartments for each of the two internal Level IIIA ballistic panels.
- Capable of stopping .44 Magnum and .357 Magnum bullet, with maximum backface deformation of 44 mm.
- Carrier vest and ballistic panels combo includes two separate Level IIIA ballistic panels. The front and rear ballistic panels extend to each side and overlap the front and rear ballistic panels for more side coverage.
- Made with PE fabrics.
- Flexible soft panel design allows the panel to conform to body shape.
- Ballistic panels are fully sealed to protect against liquids, chemicals, and other harsh elements.
- Back panel has the two into one elastic strap on each side that wraps around each side of the wearer and secures to the front panel via hook and loop fasteners.

VEST & CHEST RIGS



BACK SIDE>



TACTICAL VEST

COLORS	SIZES		
	XSML-SMALL	MED -2XL	2XL +
Black	CTVC2916B	CTV2916B	CTVL2916B
Green	CTVC2916G	CTV2916G	CTVL2916G
Tan	CTVC2916T	CTV2916T	CTVL2916T
Urban Gray	CTVC2916U	CTV2916U	CTVL2916U
Pink Camo	CTVC2916PC	-	-
Woodland Camo	CTVC2916WC	CTV2916WC	CTVL2916WC
Digital Camo	CTVC2916D	CTV2916D	CTVL2916D
White	-	CTV2916WH	-

- 1. Tactical vest length is adjustable via triple shoulder hook and loop panels
- 2. Inside back panel has a compartment for hydration bladder
- 3. Utility pouch
- 4. **3 PISTOL MAG POUCHES**
*2 pistol mag pouches for XS-SM vests
- 5. **3 RIFLES MAG**
*2 pouches for XS-SM vests
- 6. Pistol belt includes 2 pouches for pistol mags, flashlight, multi-tool, etc
- 7. Adjustable side straps
- 8. Heavy duty drag handle

PALS/ MOLLE MODULAR VEST

COLORS	SIZES	
	MED -2XL	
Black	CPV2915B	
Green	CPV2915G	
Tan	CPV2915T	
Urban Gray	CPV2915U	
Digital Camo	CPV2915D	



- 1. Heavy duty drag handle
- 2. Vest length is adjustable via triple shoulder hook and loop panels
- 3. Heavy double mesh lined with reinforced nylon PALS webbing cover this vest from top to bottom
- 4. **PISTOL BELT** includes two pistol mag pouches
- 5. Adjustable side straps

VEST & CHEST RIGS

BACK SIDE>



HUNTING VEST

COLORS		
	Blaze Orange	CHV2942TO
	NcSTAR Camo	CHV2942NC





NEW

1. Hunting vest length is adjustable via triple shoulder hook and loop panels
2. Large game pouch
3. Shotshell elastic loops
4. 2 large main front pockets (each holds a full box of 25 shells)
5. Adjustable side straps

BACK SIDE>



PLATE CARRIER VEST

COLORS		
	Black	CVPCV2924B
	Green	CVPCV2924G
	Tan	CVPCV2924T
	Urban Gray	CVPCV2924U
	Digital Camo	CVPCV2924D

1. Hook and loop for name tags, patches
2. Removable shoulder pads with PALS webbing
3. Fully adjustable shoulder straps
4. Heavy duty drag handle
5. PALS webbing for custom configuration
6. Compatible with 10" x 12" hard plates
7. Adjustable side panels for comfort and mobility. 6" x 6" side plates compatible

VEST & CHEST RIGS



AR CHEST RIG

COLORS		
	Black	CVARCR2922B
	Green	CVARCR2922G
	Tan	CVARCR2922T
	Urban Gray	CVARCR2922U
	Digital Camo	CVARCR2922D

1. Hydration bladder compatible **(Bladder not included)**
2. Adjustable side straps
3. Six double AR mag pouches with bungee retention straps **(holds up to 12 mags)**
4. Heavy duty drag handle



AR & PISTOL MAGS CHEST RIG

COLORS		
	Black	CVARPCR3031B
	Green	CVARPCR3031G
	Tan	CVARPCR3031T
	Urban Gray	CVARPCR3031U

- Chest rig with integrated rifle and pistol magazine pouches.
- Includes three dual AR magazine pouches with bungee cord retention straps for each of the magazines for carrying up to six metal or polymer AR15 thirty round magazines in front of the chest rig.
- In front of each of the AR magazine pouches are two pistol magazine pouches for standard capacity pistol double stack magazines, with adjustable hook and loop flaps.
- One central 11.5"W x 7.0"H compartment behind the magazine pouches, with hook and loop fastener top closure.
- Padded shoulder straps are fully adjustable for length, for adjusting how high or low the AR Chest Rig sits on the chest.
- The shoulder straps have top mounted quick connect buckles and two side swiveling quick connect buckles for a more ergonomic fit. Shoulder straps cross over at the back for a more secure fit.
- Each shoulder strap has a metal D-ring and three rows of MOLLE for attaching additional accessories to the shoulder straps.
- A waist strap with quick connect buckles is adjustable up to 66" around the chest, to fit over most gear and body armor.



AK CHEST RIG

COLORS		
	Black	CVAKCR2921B
	Green	CVAKCR2921G
	Tan	CVAKCR2921T
	Urban Gray	CVAKCR2921U
	Woodland Camo	CVAKCR2921WC
	Digital Camo	CVAKCR2921D

1. One belly pouch for additional equipment
2. Three double AK mag pouches with bungee retention straps **(holds up to 6 magazines)**
3. Two gear pouches

VEST & CHEST RIGS

BACK SIDE>



BLACK OUTER CARRIER VEST W/FOUR LEVEL IIIA BALLISTIC PANELS

COLORS	SIZES					
	SMALL	MED	LARGE	XL	2XL	3XL
Black	BSO3AVBS	BSO3AVBM	BSO3AVBL	BSO3AVBXL	BSO3AVB2XL	BSO3AVB3XL

- Front and back panels have separate internal compartments for each of the four Level IIIA ballistic panels included in the combo.
- Capable of stopping .44 Magnum and .357 Magnum bullet, with maximum backface deformation of 44 mm.
- Includes four separate Level IIIA ballistic panels. Front and rear ballistic panels extend to each side for more coverage and the two separate ballistic side panels that overlap the front and rear ballistic panels, for more side coverage.
- Flexible soft panel design allows the panel to conform to body shape.
- Ballistic panels are fully sealed to protect against liquids, chemicals, and other harsh elements.
- On the outside of the carrier vest, the front and back panels each have a 10.5"W x 12.0" external pocket with a hook and loop flap for adding external up-armor ballistic plate armor (not included).
- The shoulders each have a triple flap hook and loop strap system, for adjusting how high/low the vest sits on the wearer.
- The back panel has the two integrated ballistic side panels that wrap around both sides of the wearer and secures to the front panel via hook and loop fasteners.



TACTICAL MOLLE SEAT PANEL ORGANIZER

COLORS	SIZE
	(7.0"H X 7.25"W X 2.0"D)
Black	CVTACSEAT3034B

- Tactical MOLLE seat panel organizer mounts behind most vehicle driver's and passenger bucket seats.
- Seat panel organizer has nine columns and seven rows of MOLLE webbing on the top section of the seat panel for attaching MOLLE compatible accessories and pouches.
- 16.5"L top strap with a quick connect buckle to secure around the seat headrest up to 24.5" around.
- There are two pockets on the bottom of each corner for storing items. Pockets can accommodate the butt stocks of most long guns for mounting them vertically. On the top corners of the seat panel are two hook and loop straps for securing around a barrel or handguard.
- There is an internal pocket in the middle of the MOLLE panel with hook and loop securing options.
- On each corner of the seat panel are metal D-rings for additional mounting/securing options.
- Quick connect buckle attached to an adjustable 47"L bottom strap fits around 62" seats.

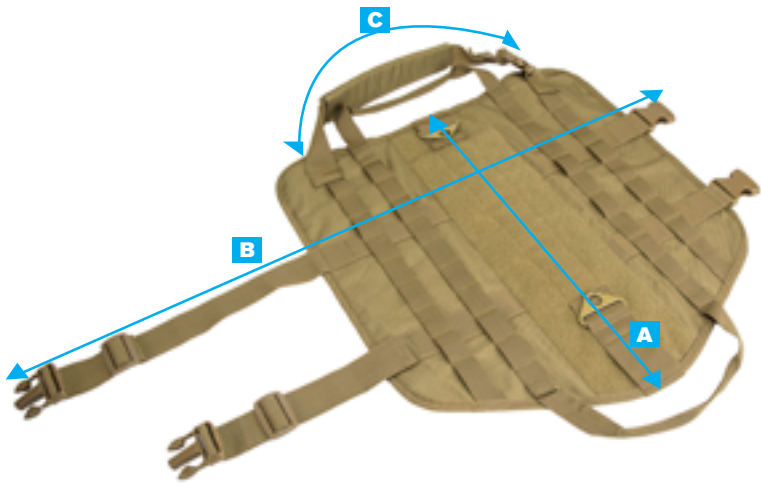

SIZING CHART (INCHES)			
	A	B	C
MED	14.5"	15.5"-27.5"	10"-13"
LARGE	19"	18"-34"	14"-18"

K9 TACTICAL MOLLE VEST		
COLORS	SIZES	
	MED	LARGE
Black	CVK93005BM	CVK93005BL
Tan	CVK93005TM	CVK93005TL
Red	CVK93005RM	CVK93005RL

- Two rows of PALS webbing on the side panels for attaching MOLLE pouches to the vest.
- Two metal ring loops located on the back. One of the ring loop located over the shoulders and one by the hip for attaching leads/leashes.
- Two webbing handles for handling the K9 or lifting the dog over obstacles. One of the handles located over the shoulders and one by the hip.
- One adjustable neck strap with a padded cover (with hook and loop fastener) for the K9's comfort.
- Two adjustable torso straps with quick connect buckles for the proper fitment on the K9.
- Wide strip of loop fastener down the backbone of the K9 vest for attaching name tapes and patches.
- Breathable mesh fabrics on the inside of the vest





• VEST NOT INCLUDED

PLATE CARRIER - TACTICAL VEST BAG	
COLORS	SIZE
	(21.5"L x 22.0"W x 3.5"D)
Black	CLVSTBAG2982B
Green	CLVSTBAG2982G
Tan	CLVSTBAG2982T

- Padded bag for protecting, storing, and carrying your plate carrier/tactical vest.
- A loop of webbing inside with hook and loop fasteners for holding up your carrier/ vest inside the bag. Just loop the webbing around the drag handle to hold it up.
- Reinforced wrap-around carry handles

BACKPACKS

3 DAY BACKPACK

COLORS		SIZE
		(20"H X 12"W X 10.5"D)
 Black		CB3D3013B
 Green		CB3D3013G
 Tan		CB3D3013T

- Durable 1100 denier nylon construction and heavy duty zippers.
- Zippered expandable pocket with six rows of MOLLE webbing and loop fastener.
- Bottom front zippered compartment with several mesh pockets and has two rows of MOLLE webbing on the outside.
- 4 each - side compression straps with quick connect buckles.
- Two side and one top mounted heavy duty carry handle straps.
- Side zippered pockets on each side of the backpack with MOLLE webbing.



The main compartment with 3 internal mesh pockets. With lockable metal zippers.



Waist strap adjustable out to 57"L. Thickly padded back side has a large zippered compartment with hang tabs for a hydration bladder and drink tube pass throughs.



Top front zippered compartment with several internal pockets to organize your gear, with lockable metal zippers.



Top outside vertically zippered expandable pocket with six rows of MOLLE webbing and loop fastener patch area for name tape or patch.

TAKEDOWN CARBINE BACKPACK

COLORS		SIZE
		(23"H X 15"W X 12"D)
 Black		CBTD3015B

- The top front zippered compartment with two internal pockets. Side mesh pockets on each side of the backpack.
- Adjustable padded shoulder straps and a sternum strap with quick connect buckles. Thick back padding and a large zippered compartment.
- Bottom front lockable zippered compartment with ultra-long magazine pouches (9"L) running the full width of the compartment with hook & loop flaps on both ends. This allows you to use sub-compact, double stack standard capacity magazines, and even 30+ extended capacity magazines.



Main compartment with an internal main pouch with flap for a takedown stock/ receiver section and two pouches with flaps for the barreled assemblies. With lockable metal zippers.



The mag pouches can hold up to 10 standard capacity double stack magazines.



Middle compartment with MOLLE webbing for attaching MOLLE compatible gear inside the backpack and a large zippered mesh pocket for more gear. With lockable metal zippers.



TakeDown Carbine backpack is perfectly suited for the Ruger® PC Carbine, take down 10/22 models, or any other take down carbines with less than 19" long sections.

DAY BACKPACK

COLORS	SIZE
	(18.0"H X 12.0"W X 6.0"D)
 Black	CBDPB2979

Day backpack has several compartments to carry and organize all your essential gear. The Day backpack has two main large zippered compartments, and three outside zippered compartments.

- 5 compartments
- Heavy duty zippers with metal pull tabs.
- Heavy duty carry strap mounted on top.
- Hydration bladder compatible
- Made from Nylon material



The perfect Day backpack for work, school, the gym, and for other recreational activities.



Side mesh pocket with elastic top for holding a water bottle



Adjustable shoulder straps with thick padding, for comfort.



Two hydration hose pass through grommets with hook and loop flaps.



Many of the compartments have internal dividers, smaller pockets, and a hook for securing your keys

- Loop fastener patches
- Top Front Pocket: 71.3 cu. in. of space







Middle compartment 18" H x 12" W x 2.5" D (540 sq inches). With a large mesh internal zippered compartment, 3 pockets, and two pen pockets.



Hydration bladder compatible, with drink tube routing onto either of the padded shoulder straps.

ASSAULT BACKPACK

COLORS	SIZE
	(20.0"H x 13.0"W x 13.0"D)
 Black	CBAB2974
 Green	CBAG2974
 Tan	CBAT2974
 Urban Gray	CBAU2974
 Digital Camo	CBAD2974

- Multiple compartments and MOLLE webbing to organize and customize your backpack to your needs. With over 2,200 sq inches of storage capacity.
- Main compartment dimensions: 18" H x 12" W x 6.5" D (1,404 sq inches). With Hydration compatible compartment, two large pockets, zippered compartment, and two smaller pockets.
- Top Outside Compartment: 5" H x 10.25" W x 1.25" D (64 sq inches), 1" H X 5" W loop fastener for attaching Name Tape. With two internal pockets.
- MOLLE compatible webbing on the front & bottom pockets, shoulder straps, and the sides of the backpack.
- Durable PVC construction that is chemical and water resistant.
- Adjustable sternum and waist straps with quick connect buckles



COMBINATION LOCK

ALOCK

Purchase separately. Compact keyless three wheel combination padlock.

BACKPACKS

SLING UTILITY BAG

COLORS		SIZE
		(20.0"H x 13.0"W x 13.0"D)
	Black	CVSUB3025B
	Green	CVSUB3025G
	Tan	CVSUB3025T
	Urban Gray	CVSUB3025U
	Blue	CVSUB3025BL
	Digital Camo	CVSUB3025D
	Green Tan	CVSUB3025GT
	Red	CVSUB3025R
	Tan w/Gray Trim	CVSUB3025TU
	Wood Cam	CVSUB3025WC



Main zippered compartment measures 11.0"H X 8.0"W X 3.5"D.



Front compartments have PALS webbing for attaching additional MOLLE gear. Hook fastener patch area for attaching a patch.



Three front mounted zippered compartments for organizing your gear. Multiple pockets and elastic bands to keep your stuff organized. A strap with a plastic hook for getting to your keys quick and easy.



1. A large padded and adjustable shoulder sling provides for a comfortable carrying of the Utility Bag. Shoulder sling has a large 2.25"W plastic quick connect buckle. Adjustable sliders to adjust the sling fit to your body. The shoulder sling terminates with a plastic snap hook to attach to the either right or left side D-ring, so you can carry the Utility bag on either side of your body.
2. Shoulder sling also has an adjustable cross body strap with sliders and a quick connect buckle to secure the Utility Bag close to the body and to reduce swinging.
3. Main compartment has zippered and hook and loop pockets for organizing your everyday gear with a large sewn in hook patch area for placing a hook fastener CCW holster.
4. Rear pocket has a padded rubberized non slip surface and a hook and loop fastener webbing for securing the Utility Bag to your belt.
5. Top mounted Neoprene hand strap 5.25"W with plastic D-rings.
6. Four rows of PALS webbing on the sides of the Utility Bag for attaching MOLLE accessories to the bag

- The front top compartment measures 7.25"W X 3.25"H X 1.25"D, the bottom compartment is 7.25"W X 7.0"H X 1.5"D,
- Four rows of PALS webbing on the sides of the Utility Bag for attaching MOLLE accessories to the bag
- Rear pocket with metal button fastener and with a plastic D-ring. The pocket can be used as a quick access CCW compartment. Inside the pocket it has a large 6.0"W X 5.0"H hook fastener patch section sewn in for attaching hook fastener CCW holster.



- Lockable Concealed Pistol Compartment: 16.0" H x 10.0" W. Metal zipper & small padlock loops
- 🔒 Padlock not included



Main Zippered Compartment: 16.0" H x 10.0" W x 4.5" D. Inside: Zippered and mesh internal pockets



Middle Zippered Compartment: 15.0" H x 9.5" W x 2.5" D. Inside: Mesh internal pockets



Front Bottom Compartment: 9.5" H x 8.5" W x 2.0" D. Inside: pocket organizer



A discreet way of carrying a concealed carry weapon. (Holster and pistol not included)

SLING BACKPACK	
COLORS	SIZE
	(16.5"H x 10.3"W x 10.5"D)
Black	CBMSB2959
Green	CBMSG2959
Tan	CBMST2959
Urban Gray	CBMSU2959
Blue w/ Black Trim	CBMSL2959

1. Concealed Carry Compartment
2. Adjustable padded solo strap with side support strap
3. Front Top Compartment: 4.0" H x 7.0" W x 1.75" D
4. Water bottle holder for 32 oz. bottle

BACKPACKS

SMALL BACKPACK

COLORS		SIZE
		(17.0"H x 8.7"W x 10.0"D)
	Black	CBSB2949
	Green	CBSG2949
	Tan	CBST2949
	Urban Gray	CBSU2949
	Blue w/ Black Trim	CBSBL2949
	Red w/ Black Trim	CBSR2949
	Tan w/ Urban Gray Trim	CBSTU2949
	Green w/ Tan Trim	CBSGT2949
	Woodland Camo	CBSWC2949
	Digital Camo	CBSD2949

1. Main Zippered Compartment: 669 cu. in. of space
2. Middle Zippered Compartment: 330 cu. in. of space
3. Top Front Pocket: 70 cu. in. of Space
4. Loop fastener patch
5. Bottom Front Pocket: 175 cu. in. of Space



COMBINATION LOCK

ALOCK

Compact keyless three wheel combination padlock. Purchase seperately.



Hydration Bladder Compatible, drink tube routing on padded shoulder straps (bladder not included)



Adjustable sternum and waist straps with quick connect buckles



Hydration Bladder Compatible, drink tube routing on padded shoulder straps (bladder not included)



Adjustable sternum and waist straps with quick connect buckles

TACTICAL BACKPACK

COLORS		SIZE
		(18.0"H x 12.0"W x 6.0"D)
	Black	CBB2911
	Green	CBG2911
	Tan	CBT2911
	Urban Gray	CBU2911
	Blue w/ Black Trim	CBL2911
	Black w/ Pink Trim	CBPK2911
	Black w/ Purple Trim	CBPR2911
	Pink Camo	CBPC2911
	Red w/ Black Trim	CBR2911
	Green w/ Tan Trim	CBGT2911
	Tan w/ Urban Gray Trim	CBTU2911
	Woodland Camo	CBWC2911
	Digital Camo	CBD2911

1. Top Outside Compartment: 8.0" H x 4.5" W x 2.0" D
2. Main Compartment: 18.0" H x 12.0" W x 6.0" D
3. Side Compartments: 5.0" H x 5.0" W x 1.5" D
4. Bottom outside Compartment: 9.5" H x 9.5" W x 3.0" D

CONCEALED CARRY PURSES

VISM® BY NcSTAR®



Each purse includes various pockets and storage compartments for securing your valuables



Handgun compartment is accessible from both left and right sides with zipper closures



(CVHOLV2998B)

Each purse includes an ambidextrous holster that is held firmly in place using a hook and loop system

CONCEALED CARRY PURSES

CONCEALED CARRY



SATCHEL SMALL

1. BWI002

Wide variety of stylish purses with easily accessible hidden compartments designed to safely and securely conceal your favorite handgun. With the included ambidextrous holster, you can configure your purse in a number of different ways to accommodate your draw.



TOTE BAG



BRAIDED SHOULDER BAG



HOBO BAG



QUILTED HOBO BAG

TOTE BAG: 2. BWA001 3. BWA002 4. BWA003
HOBO BAG: 8. BWC001 9. BWC002 10. BWC003

BRAIDED SHOULDER BAG: 5. BWB001 6. BWB002 7. BWB003
QUILTED HOBO BAG: 11. BWD001 12. BWD002 13. BWD003

CONCEALED CARRY PURSES



SATCHEL

BRAIDED TOTE

SHOULDER BAG

QUILTED TOTE



PRINTED TOTE



WOVEN TOTE



QUILTED HOBO LARGE



HOBO BAG LARGE



TOTE BAG LARGE



WOMENS BACKPACK

SATCHEL: 14. BWE001 15. BWE002 16. BWE003
BRAIDED TOTE: 17. BWF001 18. BWF002 19. BWF003
SHOULDER BAG: 20. BWG001 21. BWG002 22. BWG003
QUILTED TOTE: 23. BWH001 24. BWH002 25. BWH003

PRINTED TOTE: 26. BWJ001 27. BWJ002 28. BWJ003
WOVEN TOTE: 29. BWK001 30. BWK002 31. BWK003
QUILTED HOBO LARGE: 32. BWL001 33. BWL002 34. BWL003
HOBO BAG LARGE: 35. BWM001 36. BWM002 37. BWM003
TOTE BAG LARGE: 38. BWN001 39. BWN002 40. BWN003
WOMENS BACKPACK: 41. BWP001 42. BWP002 43. BWP003

CONCEALED CARRY PURSES

CONCEALED CARRY



DAISY CROSSBODY SACHEL



SMALL DOME CROSSBODY BAG



QUILTED CROSSBODY BAG



MESSENGER CROSSBODY BAG



CROSSBODY BAG



SMALL MESSENGER CROSSBODY





DAISY CROSSBODY SACHEL: 44. BWQ001 45. BWQ002 46. BWQ003
 SMALL DOME CROSSBODY BAG: 47. BWR001 48. BWR002 49. BWR003
 QUILTED CROSSBODY BAG: 50. BWS001 51. BWS002 52. BWS003

MESSENGER CROSSBODY BAG: 53. BWT001 54. BWT002 55. BWT003
 CROSSBODY BAG: 56. BWU001 57. BWU002 58. BWU003
 SMALL MESSENGER CROSSBODY: 59. BWV001 60. BWV002 61. BWV003

CONCEALED CARRY



CCW SACHEL

COLORS	SIZE
	(9.0"H X 7.5"W X 4.75"D)
 Black	CVSTCHL2999B
 Blue	CVSTCHL2999L
 Tan	CVSTCHL2999T
 Urban Gray	CVSTCHL2999U



- Satchel with 3 standard zippered compartments and a hidden CCW compartment.
- A dual zippered CCW compartment that can be quickly popped open by pulling a buckle.
- Includes a universal ambidextrous holster (CVHOLV2998B) that fits many semi-autos from duty size to sub-compact pistols.
- Shoulder strap is adjustable for length.

- The middle compartment has elastic bands divided into three to hold 3 separate EDC items like: magazines/ pocket knife/ multi-tool, and there is also a top flap to cover the EDC items from view when the compartment is opened.



CCW HOLSTER WITH HOOK FASTENER STRIP

COLORS	SIZE
	(6.0" L x 4.5"H x 0.4" D)
 Black	CVHOLV2998B

- The universal CCW holster fits many semi-autos from duty size to sub-compact pistols.
- The holster has a 5.25"L X 1.5"W hook strip (hook and loop fastening system) sewn to both sides of the holster for ambidextrous mounting.
- Soft vinyl outside with soft lining interior materials.
- Holster is sewn with a trigger guard shape to conform around the pistol and to protect the trigger area.
- Handgun and magazine not included with holster.

CONCEALED CARRY



CCW compartment measures 12.5"W X 8.5"H X 1.4"D, with lockable metal zipper pulls.



Laptop compartment interior measures 13.25"W X 10.5"H x 1.25"D. Thickly padded on both sides and on the edges sides/top/bottom.



There is a 2.0" strap on back strap to secure the CCW Briefcase to the rollable luggage handles.



- Adjustable shoulder strap is included. Length is adjustable from 25"L - 47"L

CCW LAPTOP BRIEFCASE

COLORS	SIZE
	(14.5"L X 11.0"W X 3.0"D)
Black	CVLTBC3024B

- Padded Laptop Briefcase with a CCW compartment, a holster, and a compartment for a Level IIIA 10"X12" body armor panel.



- Laptop Compartment also has a separate compartment for a Level IIIA 10.0" X 12.0" body armor panel (not included). See page 87 for combo option



CCW compartment has a couple of interior pockets for pens and office items with large sewn in loop fastener patch section for the hook fastener holster that is included. Holster fits most subcompact to duty sized semi autos.

DOUBLE CARBINE CASES



4 Compression straps with quick release buckles



3 external pockets are perfect for keeping your magazines and ammo organized



Zippered side pockets on both sides for additional items



Padded pockets in the secondary compartment with hook and loop closures



Bungee cords on exterior pockets to secure gear



Adjustable padded shoulder straps for comfort

- Thick padded center divider

- The Primary compartment will accommodate 2 rifles



OVERALL LENGTHS:

- 36"** DOUBLE CARBINE CASE
- 42"** DOUBLE CARBINE CASE
- 46"** DOUBLE CARBINE CASE
- NEW SIZE 52"** DOUBLE CARBINE CASE
- 55"** DOUBLE CARBINE CASE



COMBINATION LOCK

A LOCK

Purchase separately. Compact keyless three wheel combination padlock. To comply with some local & State laws.



Thick padded foam around the main compartment to protect firearms

4 hook and loop straps to properly secure each rifle

Lockable main compartment. Metal zippers with small padlock loops
Padlock not included



DOUBLE CARBINE CASES

COLORS		SIZES				NEW SIZE	
		36" (36.0" Lx 11.5"H x 3.0" D)	42" (42.0" Lx 11.5"H x 3.0" D)	46" (46.0" Lx 11.5"H x 3.0" D)	52" (52.0" Lx 11.5"H x 3.0" D)	55" (55.0" Lx 11.5"H x 3.0" D)	
	Black	CVDC2946B-36	CVDC2946B-42	CVDC2946B-46	CVDC2946B-52	CVDC2946B-55	
	Green	CVDC2946G-36	CVDC2946G-42	CVDC2946G-46	CVDC2946G-52	CVDC2946G-55	
	Tan	CVDC2946T-36	CVDC2946T-42	CVDC2946T-46	CVDC2946T-52	CVDC2946T-55	
	Urban Gray	CVDC2946U-36	CVDC2946U-42	CVDC2946U-46	CVDC2946U-52 <small>NEW</small>	CVDC2946U-55	
	Blue w/ Black Trim	CVDC2946BL-36	CVDC2946BL-42	CVDC2946BL-46	CVDC2946BL-52	CVDC2946BL-55	
	Purple w/ Black Trim	CVDC2946PR-36	-	-	-	-	
	Woodland Camo	CVDC2946WC-36	CVDC2946WC-42	CVDC2946WC-46	CVDC2946WC-52 <small>NEW</small>	CVDC2946WC-55	
	Digital Camo	CVDC2946D-36	CVDC2946D-42	CVDC2946D-46	CVDC2946D-52	CVDC2946D-55	

DELUXE CASES

DISCREET CARBINE CASE

COLORS	SIZE
	(26.0" L x 13.0" H x 3.0" D)
 Black	CV3DIS2947B-26
 Green	CV3DIS2947G-26
 Tan	CV3DIS2947T-26
 Urban Gray	CV3DIS2947U-26

1. Fits a 16" barrel AR15 / M4 carbine, with upper & lower receivers broken down
2. 2 zippered mesh pockets perfect for storing magazines
3. Fully Padded Carbine Case to protect your rifle and gear.
4. Compartment is lined with Hook and loop fasteners and PALS webbing for custom configuration





Adjustable Shoulder Strap and Metal D-Rings to comfortably carry your Carbine Case.



I.D. Holder on the outside of the Carbine Case.

DRAG BAG

COLORS	SIZE
	(45.0" L x 10.0" H x 4.0" D)
 Black	CVDB2912B
 Green	CVDB2912G
 Tan	CVDB2912T
 Urban Gray	CVDB2912U
 Digital Camo	CVDB2912D

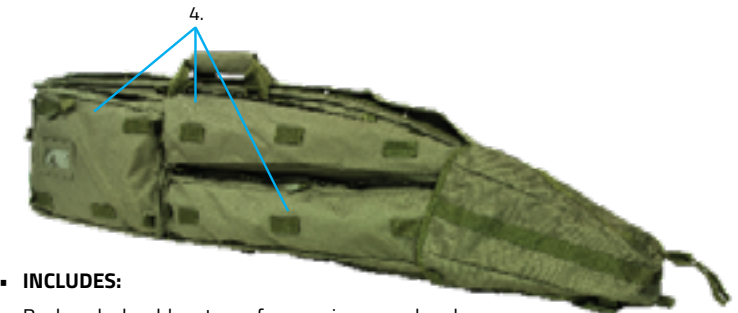

1. Straps with quick connect buckles to secure your rifles
2. Drag bag main compartment will accommodate two rifles with padded divider
3. Fully padded drag bag to protect your rifles.
4. Exterior pockets for additional gear



■ **INCLUDES:**

Backpack shoulder straps for carrying your drag bag

DELUXE RIFLE CASE

COLOR	SIZES	
	36" (36.0"H X 13.0"W X 2.0"D)	42" (42.0"H X 13.0"W X 2.0"D)
 Black	CVDRC2996B-36	CVDRC2996B-42
 Green	CVDRC2996G-36	CVDRC2996G-42
 Tan	CVDRC2996T-36	CVDRC2996T-42

- Metal lockable zipper pulls
- Two rows of ladder webbing for the hook and loop straps to secure various types of long gun(s)
- Six hook and loop straps are included to secure the long gun(s) in the main compartment.
- Two carry handle straps
- Adjustable 2" shoulder strap with shoulder pad
- I.D. pocket.
- Constructed with 600D Polyester for long life and durability.



NOTE : Measurements provided are the outside overall length & height of the gun case. We recommend you purchase a Rifle Case that is 2" longer than your rifle's overall length.

36" THREE rifle magazine pouches with elastic band retention.

42" FOUR rifle magazine pouches with elastic band retention.



SHOOTING MATS



ROLLS UP INTO A COMPACT SIZE:
19.5" W X 8.5" H

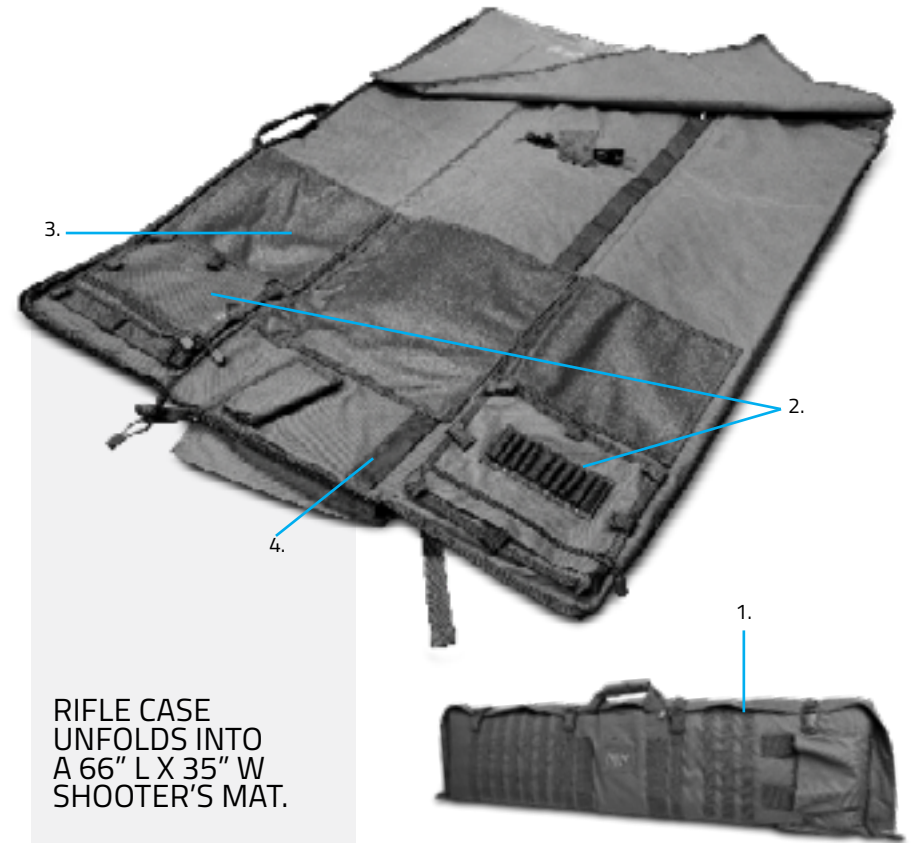

RIFLE CASE UNFOLDS INTO
A 66" L X 35" W
SHOOTER'S MAT.

ROLL UP SHOOTING MAT

ROLL UP SHOOTING MAT	
COLORS	SIZE
	69" x 35" (69.0" L x 35.0" H x 0.3" D)
Black	CVSHMR2957B
Green	CVSHMR2957G
Tan	CVSHMR2957T
Urban Gray	CVSHMR2957U
Woodland Camo	CVSHMR2957WC
Digital Camo	CVSHMR2957D

1. Padding can also serve as ground padding under a sleeping bag when camping overnight.
2. Elbow and knee slip resistant panels
3. Two hook and loop straps secure the shooting mat while rolled up
 - Shoulder strap can serve double duty to help secure your firearm bipod in place, preventing the rifle from moving forward under recoil.
 - Made with tough and durable PVC material that is water and chemical resistant. Re-reinforcement cross stitching in critical areas.

RIFLE CASE / SHOOTING MAT

RIFLE CASE / SHOOTING MAT	
COLORS	SIZE
	48" x 11" (48.0" L x 11.0" H x 1.7" D)
Black	CVSM2913B
Green	CVSM2913G
Tan	CVSM2913T
Urban Gray	CVSM2913U
Digital Camo	CVSM2913D

1. PALS webbing on exterior for MOLLE compatible gear
2. Interior panels for ballistic chart & extra ammo
3. Elbow and Knee slip resistant panel
4. One piece cleaning rod compartment
 - Rifle case transforms into a padded Shooting Mat for a more comfortable shooting platform when shooting prone.
 - Includes backpack straps for easy transporting to the range.

RIFLE CASES



Lockable main compartment with metal zipper & small padlock loops



Padlock not included

ALSO AVAILABLE

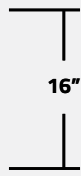

16"

2907 SERIES SCOPED RIFLE CASE

These models are extra wide to allow room for scoped rifles

SIZE	COLOR	
42" (42.0" L x 16.0" H x 1.0" D)	Black	CVS2907-42
45" (45.0" L x 16.0" H x 1.0" D)	Black	CVS2907-45
48" (48.0" L x 16.0" H x 1.0" D)	Black	CVS2907-48
52" (52.0" L x 16.0" H x 1.0" D)	Black	CVS2907-52

2907 SERIES



5 mag pouches integrated with hook and loop closure

2907 SERIES RIFLES CASE

COLORS	SIZES						
	36" L (13.0"H x 1.0" D)	38" L (13.0"H x 1.0" D)	40" L (13.0"H x 1.0" D)	42" L (13.0"H x 1.0" D)	46" L (13.0"H x 1.0" D)	48" L (13.0"H x 1.0" D)	52" L (13.0"H x 1.0" D)
Black	CV2907-36	CV2907-38	CV2907-40	CV2907-42	CV2907-46	CV2907-48	CV2907-52
Green	CVG2907-36	CVG2907-38	CVG2907-40	CVG2907-42	CVG2907-46	-	-
Tan	CVT2907-36	CVT2907-38	CVT2907-40	CVT2907-42	CVT2907-46	-	-
Urban Gray	CVU2907-36	CVU2907-38	CVU2907-40	CVU2907-42	CVU2907-46	-	-
Blue w/ Black Trim	CVBL2907-36	-	-	-	-	-	-
Black w/ Pink Trim	CVPK2907-36	-	-	-	-	-	-
Woodland Camo	CVWC2907-36	CVWC2907-38	-	CVWC2907-42 <small>NEW</small>	-	-	-
Digital Camo	CVD2907-36	CVD2907-38	CVD2907-40	CVD2907-42	CVD2907-46	-	-
NcSTAR Camo	CVNC2907-36 <small>NEW</small>	-	-	CVNC2907-42 <small>NEW</small>	-	-	-
NcSTAR Dark Camo	CVND2907-36 <small>NEW</small>	-	-	CVND2907-42 <small>NEW</small>	-	-	-



2910 SERIES RIFLE CASE		
COLOR	SIZES	
	32" (32.0" L x 10.0" H x 1.0" D)	34" (34.0" L x 10.0" H x 1.0" D)
Black	CV2910-32	CV2910-34
Green	CVG2910-32	CVG2910-34
Tan	CVT2910-32	CVT2910-34



2906 SERIES RIFLE CASE

COLORS	SIZES						
	36" (36.0" L x 9.0" H x 1.0" D)	38" (38.0" L x 9.0" H x 1.0" D)	40" (40.0" L x 9.0" H x 1.0" D)	42" (42.0" L x 9.0" H x 1.0" D)	46" (46.0" L x 9.0" H x 1.0" D)	48" (48.0" L x 9.0" H x 1.0" D)	52" (52.0" L x 9.0" H x 1.0" D)
Black	CV2906-36	CV2906-38	CV2906-40	CV2906-42	CV2906-46	CV2906-48	CV2906-52
Tan	CVT2906-36	CVT2906-38	CVT2906-40	CVT2906-42	-	-	-



2906 SERIES SCOPED RIFLE CASE

▪ These models are extra wide to allow room for scoped rifles

COLOR	SIZES			
	42" (42.0" L x 13.0" H x 1.0" D)	45" (45.0" L x 13.0" H x 1.0" D)	48" (48.0" L x 13.0" H x 1.0" D)	52" (52.0" L x 13.0" H x 1.0" D)
Black	CVS2906-42	CVS2906-45	CVS2906-48	CVS2906-52



COMBINATION LOCK

ALOCK

Purchase separately. Compact keyless three wheel combination padlock. To comply with some local & State laws.

RIFLE CASES & SHOTGUN CASES

SHOTGUN CASE



COLORS		SIZES		
		35" (35.0" L x 8.5" H x 1.0" D)	42" (42.0" L x 8.5" H x 1.0" D)	48" (48.0" L x 8.5" H x 1.0" D)
	Black	CVSH3043B-35	CVSH3043B-42	CVSH3043B-48

1. High Density foam inner padding for superior protection
2. Soft interior lining protects weapon from scratches
3. Constructed of tough 1680 Denier PVC material
4. Two external 8.0"W X 6.0"H storage pockets with hook and loop flap closures
5. Heavy duty carry strap
6. Lockable double zippers.



NOTE : Measurements provided are the outside overall length & height of the gun case. We recommend you purchase a Rifle Case that is 2" longer than your rifle's overall length.

2958 SERIES SHOTGUN CASE

COLORS		SIZES	
		48" (48.0" L x 8.0" H x 1.0" D)	54" (54.0" L x 8.0" H x 1.0" D)
	Black	CVSHB2958-48	CVSHB2958-54
	Brown	CVSHW2958-48	CVSHW2958-54
	Forest Green	CVSHG2958-48	CVSHG2958-54

1. Padded Handle
2. High Density foam inner padding for superior protection
3. Large exterior zippered compartment
4. Constructed of tough PVC material
5. Adjustable shoulder strap with metal clasp and D-rings
6. I.D. tag pocket









Measurements provided are the outside overall length & height of the gun case. We recommend a case that is +2" Longer than your long gun for a proper fit

Heavy Duty Lockable zipper.

 Padlock not included

SUBGUN, AR & AK PISTOL CASES

DELUXE SUBGUN, AR/AK PISTOL CASE

COLORS	SIZES	NEW SIZE
	28" (28.0" L x 11.5" H x 3.0" D)	32" (32.0" L x 11.5" H x 3.0" D)
 Black	CVCPD2962B-28	CVCPD2962B-32 <small>NEW</small>
 Green	CVCPD2962G-28	CVCPD2962G-32
 Tan	CVCPD2962T-28	CVCPD2962T-32
 Urban Gray	CVCPD2962U-28	CVCPD2962U-32 <small>NEW</small>
 Woodland Camo	CVCPD2962WC-28	
 Digital Camo	CVCPD2962D-28	CVCPD2962D-32



- Primary compartment will accommodate 2 AR or AK pistols/subguns up to 27" in overall length

- Deluxe double Pistol Carbine case allows for 2 AR & AK pistols, subguns, AOW, or folding carbines to be transported within the padded main compartment with a padded divider to prevent weapons from contacting each other. Additional storage pouches to store mags or other gear.
- The three large exterior pockets (2 each 7" H X 5" W and 1 each 7" H X 7" W) to store your magazines and addition gear. Pocket flaps secure via plastic quick connect buckles, hook and loop fasteners, and bungee cords help secure your gear in place.
- Four compression straps with plastic quick connect buckle on the Top and Bottom of the case to help secure your firearm and gear in place.
- Four compression straps with plastic quick connect buckle on the Top and Bottom of the case to help secure your firearm and gear in place.
- Large Heavy Duty zippers on the main compartment with lockable metal zipper pulls. Small padlock not included.
- Heavy Duty padded carry handles. Adjustable shoulder strap attaches to large metal D-Rings. Case is made from heavy duty PVC material that is water and chemical resistant.



Lockable main compartment with metal zipper & small padlock loops

3 exterior pockets to store magazines, ammo & Additional gear

Heavy Duty padded carry handles. Adjustable shoulder strap attaches to large metal D-Rings.

 **Padlock not included**





COMBINATION LOCK

ALOCK

Purchase separately. Compact keyless three wheel combination padlock. To comply with some local & State laws.

SUBGUN, AR & AK PISTOL CASES



- 4 exterior rifle magazine pouches with individual flaps, and hook & loop fasteners.

- Primary compartment will accommodate an AR or AK pistol/subgun with up to 27" in overall length



Lockable main compartment with metal zipper & small padlock loops

Padlock not included



- 4 exterior rifle magazine pouches with individual flaps, and hook & loop fasteners.

- Two case lengths available: 28", 36", and 42" to accommodate a wide variety of firearms



Lockable main compartment with metal zipper & small padlock loops

Padlock not included

28" TACTICAL SUBGUN, AR/AK PISTOL CASE

COLORS		SIZE
		28" (28.0" L x 13.2" H x 1.7" D)
	Black	CVCP2961B-28
	Green	CVCP2961G-28
	Tan	CVCP2961T-28
	Urban Gray	CVCP2961U-28
	Digital Camo	CVCP2961D-28

2960 SERIES GUN CASE

COLORS	SIZE		
	AR/AK PISTOL	CARBINE	
	28" (28.0" L x 13.0" H x 1.7" D)	36" (36.0" L x 13.0" H x 1.7" D)	42" (42.0" L x 13.0" H x 1.7" D)
Black	CVCP2960B-28	CVCP2960B-36	CVCP2960B-42
Green	CVCP2960G-28	CVCP2960G-36	CVCP2960G-42
Tan	CVCP2960T-28	CVCP2960T-36	CVCP2960T-42
Urban Gray	CVCP2960U-28	CVCP2960U-36	CVCP2960U-42
Blue w/ Black Trim	CVCP2960BL-28	CVCP2960BL-36	-
Digital Camo	CVCP2960D-28	CVCP2960D-36	CVCP2960D-42
Woodland Camo	CVCP2960WC-28 <small>NEW</small>	CVCP2960WC-36 <small>NEW</small>	CVCP2960WC-42 <small>NEW</small>

- Extendable from 22" - 29"

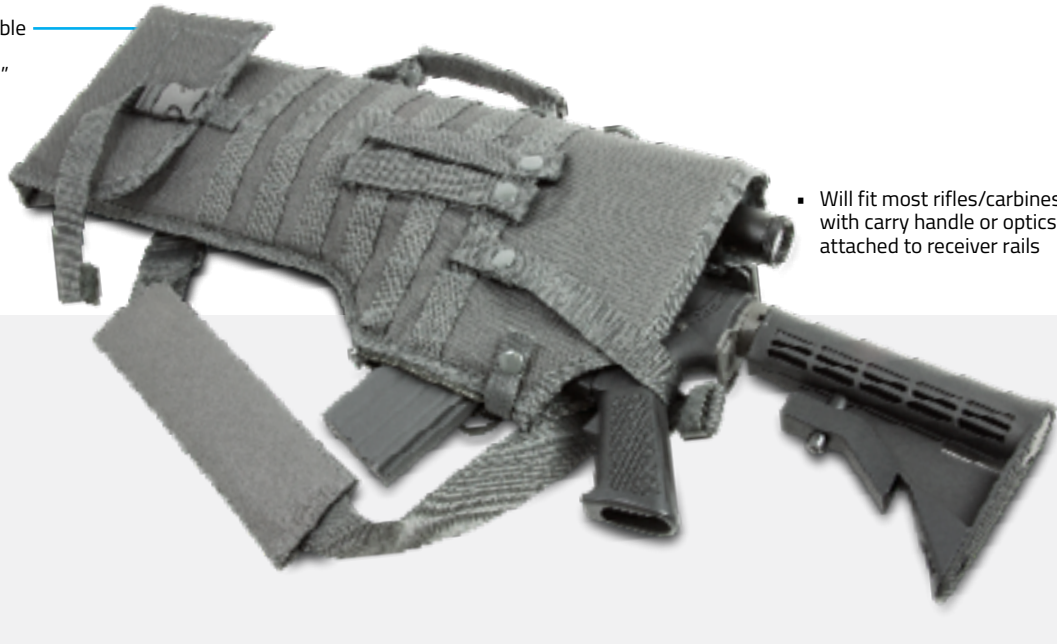

- Will fit most rifles/carbines with carry handle or optics attached to receiver rails



Designed for an easy, comfortable, and secure way of carrying a rifle/carbine over the shoulder or modular mounting onto MOLLE compatible gear, with the rifle/carbine being readily accessible

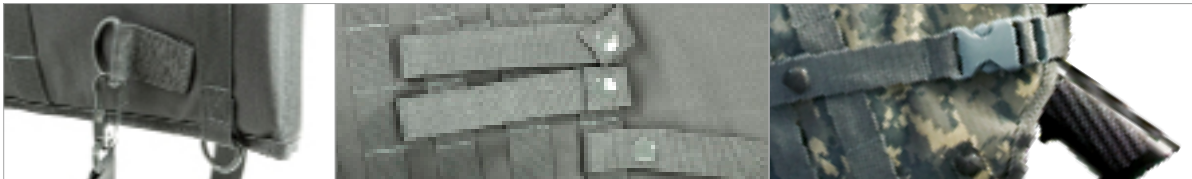









Six metal D-ring locations for attaching Included padded shoulder sling & for multiple carry options

PALS webbing on both sides of the scabbard with four detachable MOLLE straps for ambidextrous usage

Removable pistol grip retention strap with quick release buckle



RIFLE SCABBARD	
COLORS	SIZE
	(22.0" L x 9.5" H x 2.5" D)
 Black	CVRSCB2919B
 Green	CVRSCB2919G
 Tan	CVRSCB2919T
 Urban Gray	CVRSCB2919U
 Woodland Camo	CVRSCB2919WC
 Digital Camo	CVRSCB2919D
 NcSTAR Camo	CVRSCB2919NC
 NcSTAR Dark Camo	CVRSCB2919ND

NEW

NEW

SCABBARDS

NEW COLOR

- 5 elastic loops to hold shotgun shells



- Adjustable retention strap with quick release buckle

- Extendable from 20" to 25"

NEW

NEW

SBS/AOW (SHORT BARREL)	
COLORS	SIZE
	(20.0" L x 6.75" H x 2.4" D)
Black	CVXSCB3016B
Green	CVXSCB3016G
Tan	CVXSCB3016T
Urban Gray	CVXSCB3016U
Woodland Camo	CVXSCB3016WC
Digital Camo	CVXSCB3016D
NcSTAR Camo	CVXSCB3016NC
NcSTAR Dark Camo	CVXSCB3016ND



- Adjustable retention strap with quick release buckle

- Extendable from 22" - 29"

SHOTGUN SCABBARD		
COLORS	SIZE	
	(29.0" L x 6.5" H x 2.2" D)	
Black	Black	CVSCB2917B
Green	Green	CVSCB2917G
Tan	Tan	CVSCB2917T
Urban Gray	Urban Gray	CVSCB2917U
Woodland Camo	Woodland Camo	CVSCB2917WC
Digital Camo	Digital Camo	CVSCB2917D
NcSTAR Camo	NcSTAR Camo	CVSCB2917NC
NcSTAR Dark Camo	NcSTAR Dark Camo	CVSCB2917ND

NEW

NEW

SCABBARDS FEATURES



MOLLE webbing on both sides of the scabbard with four detachable PALS straps for ambidextrous usage



Six metal D-ring locations for attaching Included padded shoulder sling for multiple carry options



Grommet for drainage







▪ Stock hood, MOLLE shoulder straps, and sling are removeable

NEW

DELUXE RIFLE SCABBARD

COLORS		
	Black	CVDRSC3033B
	Green	CVDRSC3033G
	Tan	CVDRSC3033T

▪ Extendable from 32" - 38"



- The deluxe rifle scabbard has some new features and is both wider and thicker in the main body than our other standard rifle scabbard. This allows for more rifles with compact optics and accessories (lights, lasers, short vertical grips) mounted onto the handguards to fit into the scabbard. The scabbard has a 1.25" side gusset for more interior room.
- The deluxe rifle scabbard has a rifle stock hood that covers the rifle stock and the top opening of the scabbard from the elements.
- The stock hood is adjustable, has two straps with hook and loop fasteners, and two straps with quick connect buckles for attaching it to the scabbard body. 15" (hook and loop) side access flap and two quick connect buckles for quick access to the rifle.
- The deluxe rifle scabbard also features our MOLLE sholder straps for an easy and comfortable way of carrying the deluxe rifle scabbard. The shoulder straps attach to the scabbard with PALS straps.
- The padded shoulder straps are contoured, adjustable for length, feature a sternum strap with a quick connect buckle, and has metal D-rings.
- The deluxe rifle scabbard body has a 1.5" adjustable waist strap (5.0"W) with a quick connect buckle to help secure the scabbard to the body when using the shoulder straps.
- MOLLE webbing on both sides of the scabbard with two PAL straps for ambidextrous usage and mounting of MOLLE accessories.
- Rifle pistol grip retention strap with quick-release buckle, 5.0"L side zipper, and 4.5" side strap for the pistol grip slot.
- Six metal D-ring locations on the scabbard body for attaching the padded shoulder sling.
- The stock hood, MOLLE shoulder straps, and sling are removeable from the scabbard.
- Grommet for drainage.



You can mount the MOLLE Backpack Straps to a scabbard, rifle cases, and other MOLLE gear.

NEW

MOLLE BACKPACK STRAPS

COLORS		
	Black	CVMBPS3035B
	Green	CVMBPS3035G
	Tan	CVMBPS3035T

- MOLLE Backpack Straps will mount to most gear with MOLLE webbing.
- The MOLLE web mounting panel is 5 columns wide by 4 spaced rows.
- The shoulder straps are contoured, padded, and adjustable for length and comfort.
- The shoulder straps have metal D-rings.
- Feature an adjustable sternum strap with a quick connect buckle.
- Includes two 7" PALS straps.
- MOLLE Web Mounting Panel Width: 7.0"H by 9.0"W
- Padded Shoulder Strap Length: 17.0"
- Padded Shoulder Strap Width: 3.0"

RANGE BAGS & PISTOL CASES



Accommodates two standard full framed semi- auto pistols in the main compartment. The pistols are secured with 4 hook & loop straps



- Magazine pouches (9" L) allows sub- compact, double stack standard capacity magazines and 30+ extended magazines. The mag pouches can hold up to 10 standard capacity double stack magazines

- Zippered pocket for extra gear

- Includes shoulder strap



DOUBLE PISTOL RANGE BAG	
COLORS	SIZE
	(13.0" L x 10.0" H x 3.25" D)
Black	CPDX2971B
Green	CPDX2971G
Tan	CPDX2971T
Urban Gray	CPDX2971U
Digital Camo	CPDX2971D



Rear concealed carry pocket
(Holster and pistol not included)

FIRST RESPONDER UTILITY BAG

COLORS	SIZE
	(12.5" L x 8.5" H x 7.2" D)
Black	CVFRB2918B
Green	CVFRB2918G
Tan	CVFRB2918T
Urban Gray	CVFRB2918U
Blue w/ Black Trim	CVFRB2918BL
Green w/ Tan Trim	CVFRB2918GT
Tan w/ Urban Gray Trim	CVFRB2918TU
Woodland Camo	CVFRB2918WC
Digital Camo	CVFRB2918D
Red w/ Black Trim	CVFRB2918R



Two pouches for
pistol mags, flashlight,
multi-tool, etc



- Zippered mesh pocket inside the main compartment for frequently needed items

PLENTY OF SPACE WITH A TOTAL OF SEVEN COMPARTMENTS



- One rifle magazine pouch (magazines not included)



Spacious main compartment



PALS webbing and Grommets on the bottom side

RANGE BAGS & PISTOL CASES



- Removable Pullout Bag:
6.0" W x 19.0" L x 7.5" H

INCLUDES:
3 pocket Removable Organizer
and Brass Bag

EXPERT RANGE BAG	
COLORS	SIZE
	(25.5" L x 15.5" H x 10.0" D)
Black	CVERB2930B
Tan	CVERB2930T
Urban Gray	CVERB2930U
Blue w/ Black Trim	CVERB2930BL

- Main Center Compartment:**
10.0" W x 19.0" L x 9.0" H
- Front Padded Mag Compartment:**
15.0" W x 8.0" H
- Side Padded Pocket:**
4.5" W x 8.0" H
- Includes shoulder strap**
- Rear Twin Padded Compartment:**
7.8" W x 8.0" H

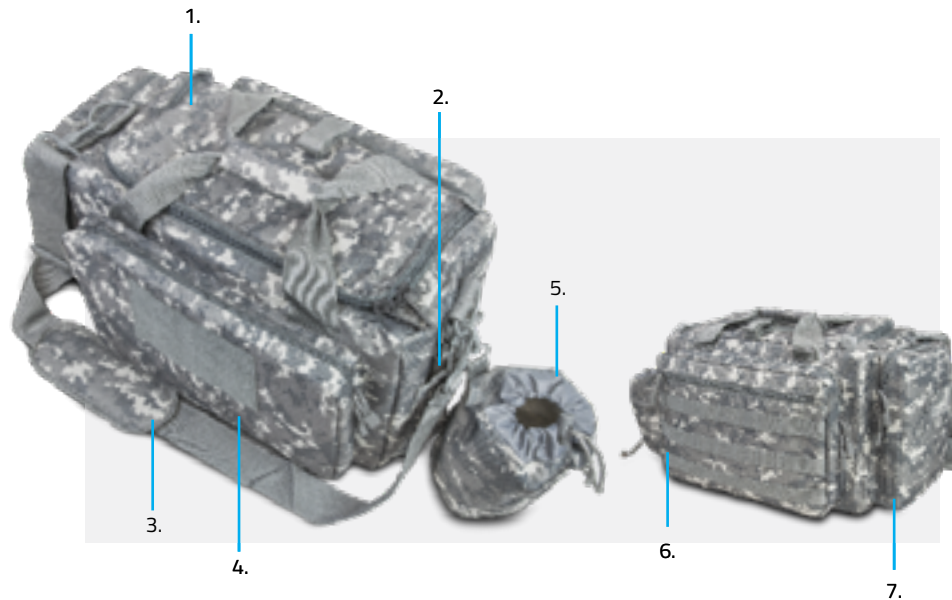

COMPETITION RANGE BAG	
COLORS	SIZE
	(20.0" L x 12.0" H x 10.5" D)
Black	CVCRB2950B
Green	CVCRB2950G
Tan	CVCRB2950T
Urban Gray	CVCRB2950U
Blue w/ Black Trim	CVCRB2950BL
Red w/ Black Trim	CVCRB2950R
Digital Camo	CVCRB2950D

- Main Center Compartment:**
7.8" W x 15.5.0" L x 10.0" H
- Side Beverage Pocket:**
Holds a 32 oz. bottle
- Includes shoulder strap**
- Front Padded Compartment:**
13.5" W x 8.5" H x 2.0" D
- Brass Bag:**
5.0" W x 6.5" H
- Rear Padded Compartment:**
7.8" W x 8.0" H
- Side Padded Pocket:**
6.8" W x 9.0" H

RANGE BAGS & PISTOL CASES

RANGE BAG & PISTOL CASES



- Padded to protect your pistol



MEDIUM PISTOL CASE

COLORS	SIZE
	(12.75" L x 7.0" H x 1.25" D)
Black	CPC3007MB
Tan	CPC3007MT
Urban Gray	CPC3007MU

- Outside length is ~11"L. Interior length is ~10"L.
- Outside height is ~7"H. Interior height is ~6.75"H.
- Heavy duty zipper with metal pull tab. Pull tab has a hole that you may use a small lock to attach to the loop webbing at the end of the pistol case. 1" loop webbing on each end for hanging onto a hook. Lock not included.
- It will fit most full size semi autos and 4" revolvers depending on accessories. Please measure pistol to be sure of size.



- 6 Elastic loops to accommodate up to 6 double stack mags or 12 single stack mags
- 2 separate padded compartments to accommodate 1 full size handgun



DISCREET PISTOL CASE

COLORS	SIZE
	(12.5" L x 7.0" H x 2.3" D)
Black	CPB2903
Green	CPG2903
Tan	CPT2903
Urban Gray	CPU2903
Blue w/ Black Trim	CPBL2903
Black w/ Pink Trim	CPBPK2903
Black w/ Purple Trim	CPBPR2903
Pink Camo	CPP2903
Woodland Camo	CPWC2903
Digital Camo	CPD2903



- Padded to protect your pistol



RANGE BAG INSERT

COLORS	SIZE
	(12.5" L x 7.0" H x 1.2" D)
Black	CV2904B
Green	CV2904G
Tan	CV2904T
Red	CV2904R
Blue	CV2904BL
Pink Camo	CV2904P
Digital Camo	CVD2904



- Interior Compartment: 13.0" L x 8.7" W x 8.0" H



RANGE BAG



COLORS	SIZE
	(13.4" L x 8.7" H x 9.2" D)
Black	CV2905
Green	CV2905G
Tan	CV2905T
Urban Gray	CV2905U



RANGE BAGS & DUFFEL BAGS





LARGE DUFFEL BAG

COLORS	SIZE
	(36" L x 12.0"H x 12.0" D)
 Black	CVDF2989B
 Green	CVDF2989G

- Heavy duty top loading duffel bag to haul all your gear. Patterned after the GI Military style duffel bag.
- Perfect for traveling, camping, hunting, or storage of your gear.
- Versatile carry: two heavy duty padded shoulder straps attached to the duffel bag for carrying over your shoulder. Duffel bag also features a carry handle strap. All of the webbing is double stitched and reinforced.
- Top of the duffel bag secures via metal loop and three metal grommets, with a metal spring loaded clip. Bag can be secured with a padlock (not included).
- 6.5" X 5.0" pocket with a button snap lid to secure documentation to the exterior of the bag.
- Weight: 36.0 oz.







SMALL DUFFEL BAG

COLORS	SIZE
	(22" L x 7.5.0"H x 10.25" D)
 Black	CVSDF3017B
 Green	CVSDF3017G
 Tan	CVSDF3017T

- Heavy duty canvas top loading duffel bag to haul all your gear. Patterned after a smaller version of the GI Military style duffel bag.
- Perfect for traveling, camping, hunting, or storage of your gear.
- Versatile carry: there is two heavy duty padded shoulder straps attached to the duffel bag for carrying over your shoulder. Duffel bag also features a carry handle strap. All of the webbing is double stitched and reinforced.
- Top of the duffel bag secures via metal loop and three metal grommets, with a metal spring loaded clip. Bag can be secured with a pad lock (not included).
- 7.5"H X 4.0"W pocket with a button snap lid to secure documentation to the exterior of the bag.
- Weight: 25.0 oz.

SMALL RANGE BAG

COLORS	SIZE
	(16.0" L x 7.0"H x 7.0" D)
 Black	CVSRB2985B
 Green	CVSRB2985G
 Tan	CVSRB2985T
 Urban Gray	CVSRB2985U
 Digital Camo	CVSRB2985D

- The range bag will easily carry a couple pistols, holster, several magazines, ammo, eye and hearing protection, and other essential range gear.
- The main compartment is 12"L X 5"W X 7"H with several pockets inside: two mesh pockets on one side and three other pockets for eye protection and other gear on the opposite side.
- A large top opening zippered lid for easy access to your gear with heavy duty zippers. Metal zippers with metal loops for attaching a small padlock (not included) to secure your gear
- On the exterior one side has PALS webbing for MOLLE compatible gear and pouches.
- Heavy duty carry handles and a fully adjustable padded shoulder strap with spring loaded plastic hooks.



MAGAZINE POUCHES



BUTTSTOCK SHOT SHELL HOLDER

COLORS	SIZE
	(6.0"L x 4.0"W)
Black	CVSSG2994B
Green	CVSSG2994G
Tan	CVSSG2994T

- Heavy duty two-way stretch elastic base will stretch over most standard shotgun stocks and stay securely in place.
- 5 elastic loops to hold five individual shotshells of 20 gauge to 12 gauge.



BUTTSTOCK RIFLE CARTRIDGE HOLDER

COLORS	SIZE
	(6.0"L x 3.6"W)
Black	CVSRC2993B
Green	CVSRC2993G
Tan	CVSRC2993T

- Heavy duty two-way stretch elastic base will stretch over most standard rifle stocks and stay securely in place.
- 9 elastic loops to hold nine individual cartridges that will hold most hunting cartridges from .223, .308 and up.

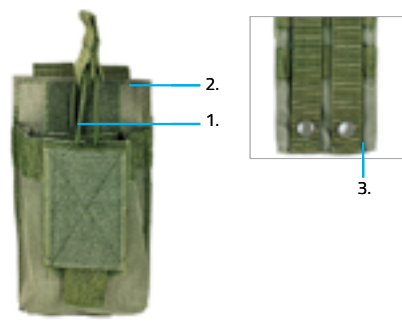

SINGLE AR MAG POUCH

COLORS	SIZE
	(6.5"L x 3.5"W x 2.0"D)
Black	CVAR1MP2929B
Green	CVAR1MP2929G
Tan	CVAR1MP2929T
Urban Gray	CVAR1MP2929U
Digital Camo	CVAR1MP2929D

1. Adjustable bungee style retention straps
2. Holds virtually any 5.56/223, or 7.62 x 39 double stack magazine
3. MOLLE straps on the back to attach to a VISM® vest, tactical backpack, or compatible rifle cases



STOCK RISER WITH MAG POUCH

COLORS	SIZE
	(6.5"L x 5.5"W x 3.3"D)
Black	CVSRMP2925B
Green	CVSRMP2925G
Tan	CVSRMP2925T

1. Ambidextrous magazine pouch can be placed on either side with hook and loop system
2. Cheek riser
3. Holds virtually any 5.56/223, or 7.62 x 39 double stack magazine
4. Mounts to stock with laced cinch cord



MOLLE 4" STRAPS (4PCS)

COLORS	SIZE
	(5.5"L x 4.3"W x 1.0"D)
Black	CVMSS3012B
Green	CVMSS3012G
Tan	CVMSS3012T
Urban Gray	CVMSS3012U



MOLLE 6" STRAPS (4PCS)

COLORS	SIZE
	(5.5"L x 4.3"W x 1.0"D)
Black	CVMSL3011B
Green	CVMSL3011G
Tan	CVMSL3011T
Urban Gray	CVMSL3011U

MAGAZINE POUCHES



(Back Side)

Attaches to:

1. Belts via Two 2.25" belt loops
2. PALS panels via two MOLLE straps



■ **MAGAZINES NOT INCLUDED**

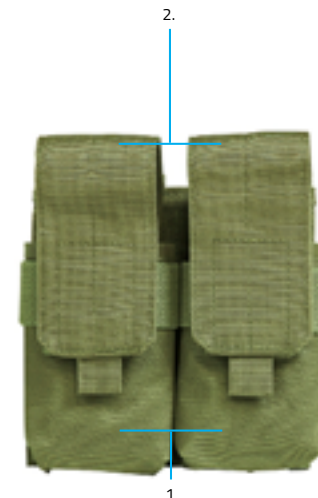
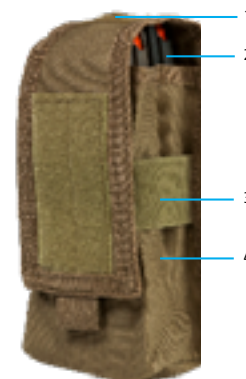

NEW

SINGLE AR MAG POUCH

COLORS	SIZE
	(3.0" L x 6.2" H x 1.2" D)
Black	CVAR1MP3039B
Green	CVAR1MP3039G
Tan	CVAR1MP3039T
Urban Gray	CVAR1MP3039T
Digital Camo	CVAR1MP3039D

1. Adjustable bungee style retention straps
2. Holds 1 AR style 5.56/223 magazines
3. MOLLE straps on the back to attach to a VISM® vest, tactical backpack, or compatible rifle cases

NEW

DOUBLE AR MAG POUCH

COLORS	SIZE
	(6.2" L x 6.2" H x 1.2" D)
Black	CVAR2MP3040B
Green	CVAR2MP3040G
Tan	CVAR2MP3040T
Urban Gray	CVAR2MP3040U
Digital Camo	CVAR2MP3040D

1. Adjustable bungee style retention straps
2. Holds 2 AR style 5.56/223 magazines
3. Two double stack pistol mag pouches
4. MOLLE straps on the back to attach to a VISM® vest, tactical backpack, or compatible rifle cases

TRIPLE AR MAG POUCH

COLORS	SIZE
	(8.7" L x 6.2" H x 1.2" D)
Black	CVAR3MP2928B
Green	CVAR3MP2928G
Tan	CVAR3MP2928T
Urban Gray	CVAR3MP2928U
Digital Camo	CVAR3MP2928D

1. Adjustable bungee style retention straps
2. Holds 3 AR style 5.56/223 magazines
3. MOLLE straps on the back to attach to a VISM® vest, tactical backpack, or compatible rifle cases

MOLLE DOUBLE RIFLE MAG / RADIO POUCH

COLORS	SIZE
	(7.5" L x 4.0" W x 2.5" D)
Black	CV2MRP2972B
Green	CV2MRP2972G
Tan	CV2MRP2972T

1. Top antenna port opening
2. Adjustable bungee style retention straps (inside flap)
3. Elastic strap for security
4. Holds virtually any 5.56/.223 double stack magazines (2)

AR15/AK47 QUAD MAG POUCH

COLORS	SIZE
	(8.0" L x 6.8" W x 3.0" D)
Black	CV5564MP2976B
Green	CV5564MP2976G
Tan	CV5564MP2976T

1. Designed to carry up to four .223/5.56 x 45/7.62 x 39/5.45 x 39 caliber AR15/AK box magazines
2. Adjustable magazine flaps with hook and loop fasteners for securing the magazines
3. Four MOLLE straps with metal button snaps make it easy to attach to compatible gear
4. Metal drain grommets and 2.5" belt loops on each side for attaching to standard belts



▪ **MAGAZINES NOT INCLUDED**



▪ **MAGAZINES NOT INCLUDED**

NEW **TSINGLE AR AND PISTOL MAG POUCH**

COLORS	SIZE
	(6.6"L x 3.3"W x 2.0"D)
Black	CVAR1MP3037B
Green	CVAR1MP3037G
Tan	CVAR1MP3037T
Urban Gray	CVAR1MP3037U
Digital Camo	CVAR1MP3037D

1. Adjustable bungee style retention straps
2. Holds a single AR style 5.56 magazine
3. A single double stack pistol mag pouch
4. MOLLE straps on the back to attach to a VISM® vest, tactical backpack, or compatible rifle cases

DOUBLE AR AND PISTOL MAG POUCH

COLORS	SIZE
	(6.6"L x 6.6"W x 2.0"D)
Black	CVAR2MP2927B
Green	CVAR2MP2927G
Tan	CVAR2MP2927T
Urban Gray	CVAR2MP2927U
Digital Camo	CVAR2MP2927D

1. Adjustable bungee style retention straps
2. Holds 2 AR style 5.56 magazines
3. Two double stack pistol mag pouches
4. MOLLE straps on the back to attach to a VISM® vest, tactical backpack, or compatible rifle cases

NEW **TRIPLE AR AND PISTOL MAG POUCH**

COLORS	SIZE
	(8.7"L x 9.9"W x 2.0"D)
Black	CVAR3MP3038B
Green	CVAR3MP3038G
Tan	CVAR3MP3038T
Urban Gray	CVAR3MP3038U
Digital Camo	CVAR3MP3038D

1. Adjustable bungee style retention straps
2. Holds 2 AR style 5.56 magazines
3. Two double stack pistol mag pouches
4. MOLLE straps on the back to attach to a VISM® vest, tactical backpack, or compatible rifle cases

NEW **8X AR MAGAZINE CARRIER/ POUCH**

COLORS	SIZE
	(8.0"L x 12.0"W x 2.5"D)
Black	CVMARC3044B
Green	CVMARC3044G
Tan	CVMARC3044T
Urban Gray	CVMARC3044U
Red	CVMARC3044R

1. Designed to carry eight 5.56 AR15 box magazines
2. Adjustable magazine flaps with hook and loop fasteners for securing the magazines
3. MOLLE compatible gear with PALS webbing sewn onto the backside of the carrier.
4. Three 2.5" belt loops on backside for attaching to a belt and 2 each metal D-rings and loops to assist with attaching to your gear or vest.
5. Adjustable 1.5"W shoulder strap included with spring retention clips. The shoulder sling is removable.

MAGAZINE POUCHES

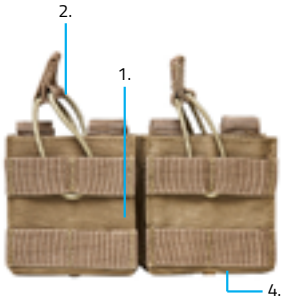

NEW

.308 SINGLE MAG POUCH

COLORS	SIZE
	{ 4.0"L x 3.4"W x 1.3"D }
Black	CV3081MP3041B
Green	CV3081MP3041G
Tan	CV3081MP3041T

1. AR10/M1A/FAL Single Magazine pouch is able to carry one .308/7.62X51 type box magazine
2. Adjustable bungee cords for securing the magazine in the pouch
3. Four MOLLE straps with metal button snaps make it easy to attach to compatible gear
4. Metal drain grommets and 2.5" belt loops on each side for attaching to standard belts

.308 DOUBLE MAG POUCH

COLORS	SIZE
	{ 4.0"L x 7.0"W x 1.3"D }
Black	CV3082MP2977B
Green	CV3082MP2977G
Tan	CV3082MP2977T

1. AR10/M1A/FAL Double Magazine pouch is able to carry two .308/7.62X51 type box magazines
2. Adjustable bungee cords for securing the magazines in the pouch
3. Four MOLLE straps with metal button snaps make it easy to attach to compatible gear
4. Metal drain grommets and 2.5" belt loops on each side for attaching to standard belts

NEW

.308 TRIPLE MAG POUCH

COLORS	SIZE
	{ 4.0"L x 10.0"W x 1.3"D }
Black	CV3083MP3042B
Green	CV3083MP3042G
Tan	CV3083MP3042T

1. AR10/M1A/FAL Triple Magazine pouch is able to carry three .308/7.62X51 type box magazines
2. Adjustable bungee cords for securing the magazines in the pouch
3. Four MOLLE straps with metal button snaps make it easy to attach to compatible gear
4. Metal drain grommets and 2.5" belt loops on each side for attaching to standard belts

AR15/M4 BRASS CATCHER

COLORS	SIZE
	{ 9.75"L x 7.5"W x 4.0"D }
Black	CVBC3014B

- Attaches to receiver with hook and loop strap
- Holds approximately 30 rounds of spent brass
- Wire frame to hold shape
- Mesh bag with zipper for easy emptying of brass



**TRIPLE MAG POUCH
HI CAP PISTOL**

COLORS	SIZE
	(8.5" L x 6.0" W x 1.5" D)
Black	CVMP3030B
Green	CVMP3030G
Tan	CVMP3030T
Urban Gray	CVMP3030D
Digital Camo	CVMP3030WC

NEW
NEW

1. The magazine flap is adjustable for magazine height via hook and loop fastener inside each of the magazine pouches. The flap is also completely removable from the mag pouch.
2. Magazine pouch has two MOLLE straps with metal button snap fastener. It is compatible with PALs system. Pouch also has belt loops on the back for attaching to your belt.
3. Holds 9mm & .40 S&W extended double stack magazines from handguns, pistol caliber carbines, and subguns with capacities of 15+, 20, 25, 30, 32 rounds will fit in this triple magazine pouch.



TRIPLE PISTOL MAG POUCH

COLORS	SIZE
	(5.5" L x 6.3" W x 1.0" D)
Black	CVP3P2932B
Green	CVP3P2932G
Tan	CVP3P2932T
Urban Gray	CVP3P2932U
Digital Camo	CVP3P2932D

1. Magazine flaps with pull tabs are adjustable for magazine height
2. MOLLE straps on back to attach to your VISM® vest, tactical backpack, or compatible rifle cases
3. Holds 3 standard capacity double stack pistol magazines

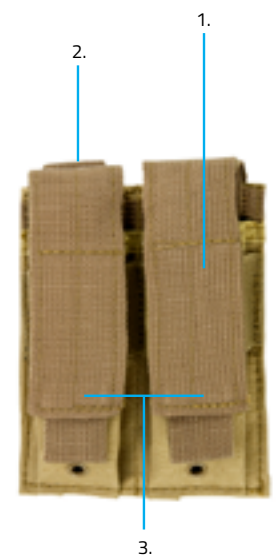

DOUBLE PISTOL MAG POUCH

COLORS	SIZE
	(5.5" L x 4.3" W x 1.0" D)
Black	CVP2P2931B
Green	CVP2P2931G
Tan	CVP2P2931T
Urban Gray	CVP2P2931U
Digital Camo	CVP2P2931D

1. Magazine flaps with pull tabs are adjustable for magazine height
2. MOLLE straps on back to attach to your VISM® vest, tactical backpack, or compatible rifle cases
3. Holds 2 standard capacity double stack pistol magazines

MAGAZINE POUCHES

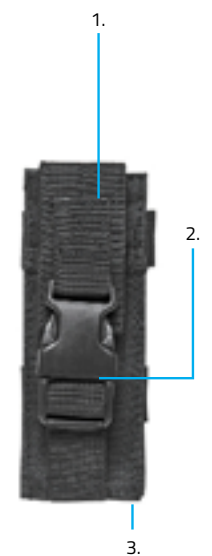

SINGLE PISTOL MAG POUCH

COLORS	SIZE
	(6.0" L x 2.3" W x 1.4" D)
Black	CVPPH2991B
Green	CVPPH2991G
Tan	CVPPH2991T
Urban Gray	CVPPH2991U
Digital Camo	CVPPH2991D

1. Holds a single standard capacity double stack pistol magazine
2. Pouch flap is adjustable for length and has a plastic quick connect buckle to secure your gear in the pouch
3. The pouch features multiple MOLLE straps (both vertical and horizontal) with metal button snaps on the back to mount in vertical or horizontal positions

HOLSTERS & ACCESSORIES



1. Large back panel with three rows of PALS webbing
2. D-rings for suspenders
3. Two rows of PALS webbing on each of the side panels
4. Large bottom opening for easy access to the pistol belt for optional drop leg gear

BATTLE BELT	
COLORS	SIZE
	ADJ. 32"L TO 48"L
Black	CVBAB2939B
Tan	CVBAB2939T
Digital Camo	CVBAB2939D
Urban Gray	CVBAB2939U



- 2.25" Tactical Belt with large quick connect buckle
- The Tactical Belt is adjustable for waist sizes 32" to 49"
- Includes two removable pouches with quick connect buckle flap.
- Inside of belt is lined with 1.25" soft loop fastening material, for hook and loop accessories.
- Includes 4 snap button belt keepers.

TACTICAL BELT W/TWO POUCHES	
COLORS	SIZE
	ADJ. 32"L TO 49"L
Black	CVBLT2978B
Green	CVBLT2978G
Tan	CVBLT2978T



- 1.5 inch Nylon webbing
- The heavy duty webbing is durable, has the stiffness for holster use, and yet it is comfortable to wear.
- Heavy duty plastic buckle does not require belt removal for metal detectors.
- Reinforced stitching.
- Available in multiples sizes from 28"L to 50"L.

BDU BELT		
COLORS	SIZES	
Black	SMALL 28"-30"	CVBLT3004BS
	MED 32"-34"	CVBLT3004BM
	LARGE 36"-38"	CVBLT3004BL
	XL 40"-42"	CVBLT3004BLX
	2XL 44"-46"	CVBLT3004B2XL
	3XL 48"-50"	CVBLT3004B3XL



- Ambidextrous MOLLE Drop Leg Panel for attaching MOLLE compatible Holsters, Magazine Pouches, and other MOLLE compatible gear.
- 5 Rows X 6 Columns of MOLLE webbing
- Attaches to Belt via two Hook & Loop & Snap Button Straps and is equipped with Quick Connect Buckle
- Drop Leg Height is adjustable.
- Rubberized backing and adjustable Thigh Strap with Quick Connect Buckles keep the Drop Leg Panel in place when you're maneuvering.
- Drop Leg Panel is made with a durable mesh material to for lightness and breathability
- A pocket (8"H X 5.5"W) with a top access hook & loop enclosure is incorporated into the Drop Leg Panel for additional storage



1. D-rings for suspenders
2. Large back panel with two rows of PALS webbing
3. Two rows of PALS webbing on each of the side panels
4. Large bottom opening for easy access to the pistol belt

MOLLE BATTLE BELT			
COLORS	SMALL	MEDIUM	LARGE
	32.0"+	36.0"+	38.0"+
Black	CVBBSM3021B	CVBBMD3021B	CVBBLG3021B
Green	CVBBSM3021G	CVBBMD3021G	CVBBLG3021G
Tan	CVBBSM3021T	CVBBMD3021T	CVBBLG3021T
Urban Gray	CVBBSM3021U	CVBBMD3021U	CVBBLG3021U

MOLLE DROP LEG PANEL	
COLORS	SIZE
	18.5"L x 20.5"W x 0.5"D
Black	CVDLMP2952B
Green	CVDLMP2952G
Tan	CVDLMP2952T
Digital Camo	CVDLMP2952D
Urban Gray	CVDLMP2952U

HOLSTERS & ACCESSORIES

THREE DIFFERENT TYPES OF RETENTION FEATURES TO KEEP THE PISTOL SECURED TO THE HOLSTER:



Adjustable thumb-Snap

Grip retention bungee cord with pull tab

1" nylon grip retention strap with quick connect buckles

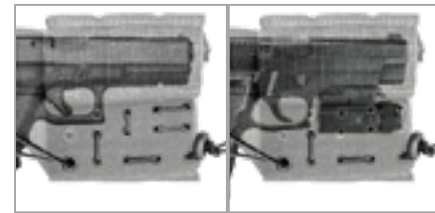

With a grid of eyelets, this holster can be configured to fit various sizes & shapes of pistols. It can also be custom configured to fit around tactical flashlights/ lasers mounted onto the frame of the pistol.



1. PALS webbing on both sides can be configured as left or right handed holster
2. Two removable MOLLE Straps with snap-buttons

AMBIDEXTROUS MODULAR MOLLE HOLSTER	
COLORS	SIZE
	(8.5"L x 5.3"W x 1.8"D)
Black	CVHOL2953B
Green	CVHOL2953G
Tan	CVHOL2953T
Urban Gray	CVHOL2953U
Digital Camo	CVHOL2953D



1. Adjustable quick connect plastic buckle retention system. The quick connect buckle can also be removed from holster body via the metal snap fastener.
2. Integral magazine pouch on the front edge of the holster to fit most standard duty sized double stack magazines (9mm & .40).
3. Hook and loop strap system to mount onto a belt. Up to 2" wide belts.

BELT HOLSTER & MAG POUCH

COLORS	SIZE
	(6.6" L x 4.4" W x 1.4" D)
Black	CVHOL3008B
Green	CVHOL3008G
Tan	CVHOL3008T

- The right-handed universal holster fits most semi-auto from duty size to sub-compact pistols.
- Durable outside material, sandwiched in between is a plastic stiffener layer with a soft interior lining material.

BELT HOLSTER & MAG POUCH

COLORS	SIZE
Black	CVHOL3032B
Green	CVHOL3032G
Tan	CVHOL3032T



- Adjustable wrap around universal vertical holster (right-handed) which features several flaps with hook and lop fasteners that overlap each flap to conform to the shape of the pistol and accessories mounted to the pistol's accessory rail.
- There is an internal hook and loop strap for fitting varying lengths of slides and for adjusting the height of the pistol in the holster which can also be easily changed to fit various pistol sizes, types, or several configurations of the same pistol.
- Holster features an adjustable thumb strap with a button snap that seures the pistol to the holster. There is also an optional secondary hook and loop strap that attaches to the thumb snap strap for additional retention.

HOLSTERS & ACCESSORIES

CUSTOMIZABLE DROP LEG MOLLE HOLSTER & PANEL SYSTEM

- A.** Universal MOLLE Pistol Holster
- B.** Drop Leg Panel with PALS Webbing
- C.** MOLLE Pistol Mag Pouch

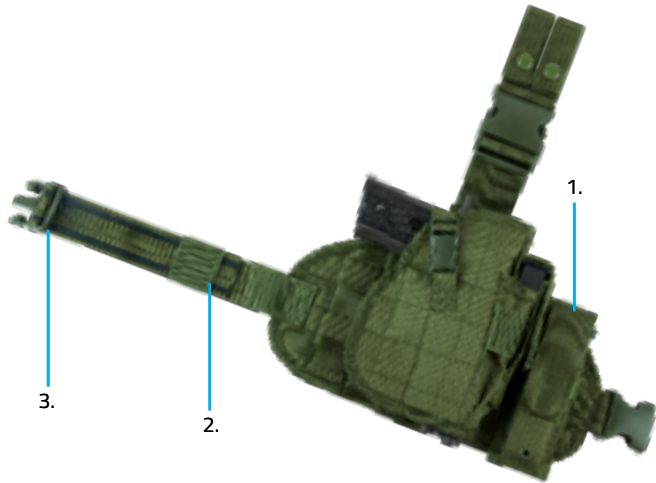

DROP LEG HOLSTER AND PANEL (RIGHT HANDED)

COLORS	SIZE
	(25.0" L x 7.5" W x 5.5" D)
Black	CVDLHOL2956B
Green	CVDLHOL2956G
Tan	CVDLHOL2956T

1. Elastic band on magazine pouch to secure magazine
2. Non-slip rubber band material for the thigh straps
3. Thigh strap maximum length of adjustment: 25"

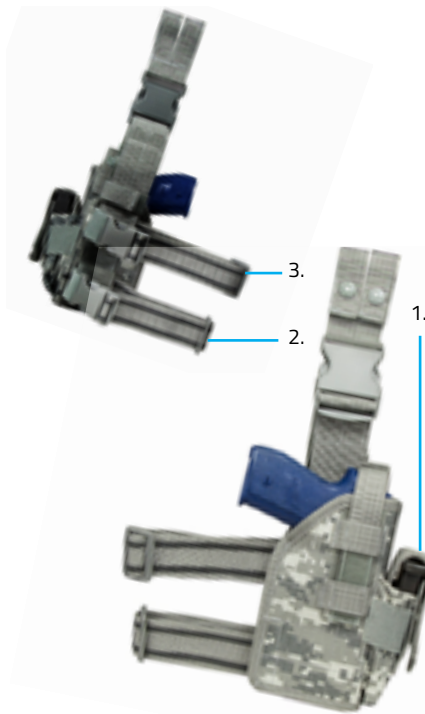

UNIVERSAL DROP LEG HOLSTER (RIGHT HANDED)

COLORS	SIZE
	(25.0" L x 7.5" W x 4.0" D)
Black	CVDLHOL2954B
Green	CVDLHOL2954G
Tan	CVDLHOL2954T
Urban Gray	CVDLHOL2954U
Digital Camo	CVDLHOL2954D
Woodland Camo	CVDLHOL2954WC

1. Elastic band on magazine pouch to secure magazine
2. Non-slip rubber band material for the thigh straps
3. Thigh strap maximum length of adjustment: 25"

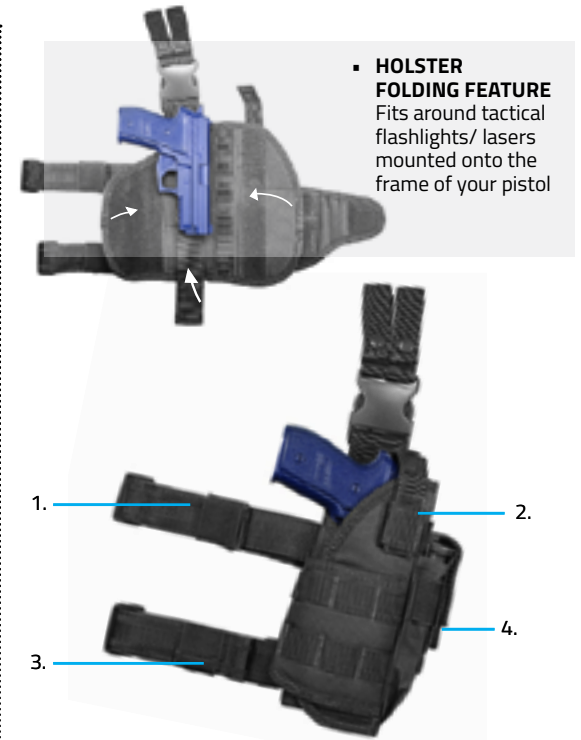

- **HOLSTER FOLDING FEATURE**
Fits around tactical flashlights/ lasers mounted onto the frame of your pistol

TACTICAL DROP LEG HOLSTER (RIGHT HANDED)

COLORS	SIZE
	(25.0" L x 9.8" W x 5.0" D)
Black	CVDLHOL2955B
Green	CVDLHOL2955G
Tan	CVDLHOL2955T
Urban Gray	CVDLHOL2955U
Digital Camo	CVDLHOL2955D
Woodland Camo	CVDLHOL2955WC

1. Non-slip rubber band material for the thigh straps
2. Adjustable thumb snap
3. Thigh strap maximum length of adjustment: 25"
4. Elastic band on magazine pouch to secure magazine



DROP LEG HOLSTER & MAG POUCHES	
COLORS	SIZE
	ADJ. 30"L TO 42"L
Black	CV2908
Green	CV2908G
Tan	CV2908T
Urban Gray	CV2908U
Woodland Camo	CV2908WC
Digital Camo	CV2908D



1. 2. 3. 4.

1. Adjustable for drop leg height with quick release buckles
2. Holster thumb snap
3. Right handed universal holster fits most full size and compact pistols
4. Single magazine pouch on holster



5. 6. 7. 1.

5. Fully adjustable belt with quick release buckle
6. Adjustable thigh straps with quick release buckles
7. Triple pistol magazine pouch with hook and loop closures



AMBIDEXTRIOUS SHOULDER HOLSTER	
COLORS	
Black	CV2909
Green	CV2909G
Tan	CV2909T
Urban Gray	CV2909U
White	CV2909WH



1. 2.

1. Adjustable hook and loop fastener flaps to ensure magazines are held securely
2. Elastic band sections allow holster to expand and contract with your body movement



4. 3.

3. All 4 shoulder straps are fully adjustable to provide a custom fit
4. Adjustable belt straps to secure holster and mag pouch in place

SLINGS

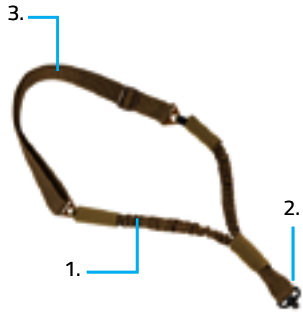

1. Heavy duty bungee cord for complete comfort and stability
2. Steel QD push button sling swivel attachment point for quick installation and removal.
3. Heavy duty 1.5" inch wide adjustable nylon

SINGLE POINT SLING W/ QD	
COLORS	SIZE
	ADJ. 46" L TO 64" L
Black	AQDBS1B
Green	AQDBS1G
Tan	AQDBS1T
Urban Gray	AQDBS1U



2-POINT TO SINGLE POINT SLING	
COLORS	SIZE
	ADJ. 54" L TO 73" L
Black	AARS21PB
Green	AARS21PG
Tan	AARS21PT

- Convert the sling from two-point to single point and back, by attaching one end of spring clip to either metal D-rings.
- The sling features 2 quick connect buckles so that you can quickly disconnect the sling from your firearm.
- Heavy duty 1.25" webbing and bungee cord.
- The sling is fully adjustable for length from 54" to 73" in two point configuration, and 31" to 40" in single point configuration

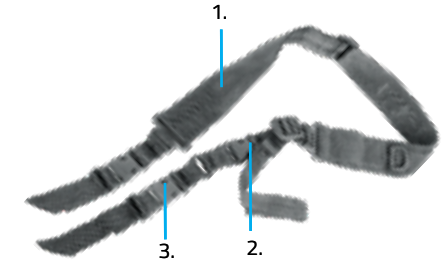

2 POINT SLING	
COLORS	SIZE
	ADJ. 56" L TO 74" L
Black	AARS2PB
Green	AARS2PG
Tan	AARS2PT
Urban Gray	AARS2PU
Pink	AARS2PP

1. Extra wide webbing and elastic bungee provide extreme comfort and durability
2. Fully adjustable straps for a perfect fit
3. Set this sling up in a dedicated two point, single point or convertible from one to two point configuration



DELUXE SINGLE POINT SLING	
COLORS	SIZE
	ADJ. 30" L TO 38" L
Black	ADBS1PB
Green	ADBS1PG
Tan	ADBS1PT
Urban Gray	ADBS1PU

- Single point bungee sling with spring loaded metal clip for quick attachment and removal from your firearm.
- Spring loaded metal clip that will easily attach to any of your standard sling loops.
- Allows for full mobility while retaining your firearm
- 3 quick connect buckles for quick detachment from your firearm.
- Heavy duty 1.25" webbing and bungee cord.
- Fully adjustable for length from 30" to 38"



SINGLE POINT SLING	
COLORS	SIZE
	ADJ. 44" L TO 60" L
Black	AARS1P
Green	AARS1PG
Tan	AARS1PT
Urban Gray	AARS1PU
Pink	AARS1PP

1. Heavy duty bungee cord for complete comfort and stability
2. Spring loaded hook clasp sling swivel attachment point for quick installation and removal.
3. Heavy duty 1.5" inch wide adjustable nylon



AK SKS SLING	
COLORS	SIZE
	ADJ. 25" L TO 41" L
Black	AAKSB
Green	AAKS
Tan	AAKST

1. Adjustable for length, with metal slider, max length: 41"
2. Replica of factory AK/SKS sling
3. Double stitch and reinforced sewn ends



MOSIN NAGANT SLING	
COLORS	SIZE
	ADJ. 24" L TO 39" L
Black	AAMNSB
Green	AAMNS

1. Adjustable for length, with metal slider, max length: 39"
2. Replica of original Mosin-Nagant sling
3. Two "dog collar" buckles

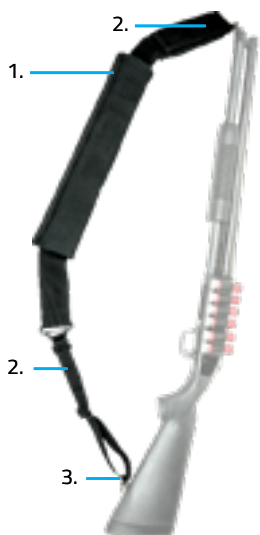

SHOTGUN BANDOLIER SLING WITH SLING SWIVEL

COLORS		SIZE
		ADJ. 33"L TO 55"L
	Black	AASHB
	Green	AASHG
	Tan	AASHT
	Woodland Camo	AASHWC

NEW



Holds 15 12G shotshells

Removable shell cover with hook and loop closure. Cover secures shotshells in place **(Shotshells not included)**

1. Removable shoulder pad with non-slip surface.
2. Elastic strap absorbs shock from carrying.
3. Lockable metal sling swivels for attaching onto sling studs.



NEW

SHOTGUN BANDOLIER

COLORS		SIZE
		(56"L x 2.25"W x 0.75"D)
	Black	AA12BANB
	Tan	AA12BANT
	Green	AA12BANG
	Urban Gray	AA12BANU

(Shotshells not included)

- Holds 56 each 12 gauge shotshells in the elastic loops.
- Bandolier is constructed with a 2" wide Nylon webbing material to spread the load over your shoulders.
- Designed to be worn over the neck and shoulder and to lay flat along the side of the body.
- Bandolier is 56" in length.
- Black Nylon web material and elastic loops.



25 SHELL CARRIER POUCH

COLORS		SIZE
		(8.25"H X 4"W X 2.25"D)
	Black	CV25SHPB
	Green	CV25SHPG
	Tan	CV25SHPT

(Shotshells not included)

- Elastic loops for securing up to 25 shotshells.
- 2x PALS straps with snap fastener. 3x2 back MOLLE webbing
- Top and side flaps with hook and loop fasteners for securing the shotshells.
- Top flap also has 4 metal button snaps for securing flap to pouch.



SHOTGUN BANDOLIER SLING

COLORS		SIZE
		(55"L x 2.25"W x 0.60"D)
	Black	AASHBANB
	Tan	AASHBANT

(Shotshells not included)

- Holds 15 each 12 gauge shotshells in the elastic loops.
- Bandolier Sling is constructed with a 2" wide Nylon webbing material to spread the load over your shoulders.
- A pair of metal spring loaded sling attachment clips, that also freely rotate.
- Bandolier sling maximum length is 51".
- Black Nylon web material and elastic loops.

SHOOTERS GEAR ACCESSORIES



- Backside of pouch includes MOLLE compatible webbing, three 2" wide belt loops, and 2 metal D-rings.



- MAGAZINES NOT INCLUDED

PISTOL MAG CARRIER POUCH - SMALL CAL. MAGS

COLORS	SIZE
	(9.75"W X 6.5"H X 1.0"D)
Black	CVMCS3019B
Green	CVMCS3019G
Red	CVMCS3019R
Tan	CVMCS3019T
Urban Gray	CVMCS3019U

- Holds up to 6 double stack magazines.
- Smaller individual magazine pouches designed for 9mm & .40 S&W double stack magazines.



- MAGAZINES NOT INCLUDED

PISTOL MAG CARRIER POUCH - LARGE CAL. MAGS

COLORS	SIZE
	(12.5"W X 6.75"H X 1.0"D)
Black	CVMCL3018B
Green	CVMCL3018G
Red	CVMCL3018R
Tan	CVMCL3018T
Urban Gray	CVMCL3018U

- Holds up to 6 large caliber double stack pistol magazines.
- Larger individual magazine pouches designed for 9mm to .45 ACP double stack magazines.

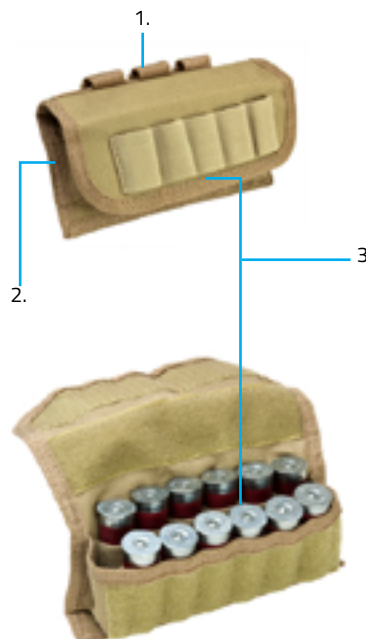

- SHOTSHELLS NOT INCLUDED

SHOTSHELL POUCH

COLORS	SIZE
	(7.0"L x 4.0"W x 2.0"D)
Black	CV12SHCB
Digital Camo	CV12SHCD
Green	CV12SHCG
Tan	CV12SHCT
Urban Gray	CV12SHCU

1. Three MOLLE
2. Two 2.25" belt loops on the back
3. Elastic loops to hold a total of 17 shotshells. There are 2 rows of elastic loops inside the pouch and a single row of 5 elastic loops on the front flap of the pouch



- MAGAZINES NOT INCLUDED

PISTOL/RIFLE MAGAZINE WALLET

COLORS	SIZE
	(14.8"L x 8.0"W x 2.5"D)
Black	CMW2937B
Tan	CMW2937T
Digital Camo	CMW2937D
Urban Gray	CMW2937U

- Open-flat design allows rapid access to all mags
- Holds up to 8 AR/AK style mags, 16 double stack pistol mags, or 32 single stack pistol mags

SHOOTERS GEAR ACCESSORIES

SHOOTERS GEAR



- TWO MOLLE straps

- **Size folded:**
5.0"L x 5.0" H x 1.2"W



FOLDING DUMP POUCH	
COLORS	SIZE
	(8.5"L x 7.5"W x 3.5"D)
Black	CVFDP2935B
Green	CVFDP2935G
Tan	CVFDP2935T
Urban Gray	CVFDP2935U
Digital Camo	CVFDP2935D

- Dump pouch unfolds into a large pouch, able to hold 7 AR or AK 30 round mags



- HANDCUFFS NOT INCLUDED

HANDCUFF POUCH	
COLORS	SIZE
	(6.0"L x 5.5"W x 1.0"D)
Black	CVHCP2973B
Green	CVHCP2973G
Tan	CVHCP2973T

- Holds one set of handcuffs (not included).
- Hook and loop flap with pull tab secures handcuffs in the pouch.
- Has two MOLLE straps with metal button snaps to secure onto PALS webbing gear.
- Pouch has 2.5" belt loops sewn to each side to secure onto a belt.



- FLASHLIGHT NOT INCLUDED

FLASHLIGHT POUCH	
COLORS	SIZE
	(5.25"L x 2.0"W x 2.0"D)
Black	CVFLP3010B
Green	CVFLP3010G
Tan	CVFLP3010T

- Work with many of the popular tactical flashlight models.
- Features an adjustable belt strap with hook and loop fastener closure helps with securing the flashlight in place.
- Metal grommet with internal fabric covering.
- Single 4.0"H PALS strap on the back to attach onto MOLLE compatible gear.



- PEPPER SPRAY NOT INCLUDED

OC SPRAY POUCH	
COLORS	SIZE
	(8.5"L x 2.0"W x 2.5"D)
Black	CVOCP3009B
Green	CVOCP3009G
Tan	CVOCP3009T
Red	CVOCP3009R

- Fit most of the popular OC pepper spray, MK3 or MK4 size sprays canisters sizes.
- Fits from 4.0" to 8.5" tall objects. Up to 1 5/8" diameter.
- Removable flap that have hook and loop fasteners that customize the height of the pouch
- Versatile pouch that you may also use for: tourniquets, 37mm smoke, and signaling cartridges.
- Features a single 4.0"H PALS strap on the back to attach onto MOLLE compatible gear.

SHOOTERS GEAR ACCESSORIES



UTILITY POUCH WITH U.S. PATCH	
COLORS	SIZE
	(7.5"L x 5.3"W x 0.75"D)
Black	CVAP3006B
Green	CVAP3006G
Tan	CVAP3006T

- US Flag PVC patch with hook and loop fasteners and mesh pocket on front of the pouch.
- Zipper pouch opens up to reveal multiple panels with internal pockets and elastic loops
- Fold out clear vinyl window pocket and a length of strap and cord with plastic hooks for clipping items.
- Pouch has two PALS straps with metal button snaps for attaching to MOLLE gear.



SMALL UTILITY POUCH	
COLORS	SIZE
	(5.5"L x 4.0"W x 2.0"D)
Black	CVSUP2934B
Green	CVSUP2934G
Tan	CVSUP2934T
Urban Gray	CVSUP2934U
Red w/ Black Trim	CVSUP2934R
Digital Camo	CVSUP2934D

- One main zippered compartment
- Two MOLLE straps on the back
- One front zippered compartment
- One quick-flap hook and loop compartment



LARGE UTILITY POUCH	
COLORS	SIZE
	(7.5"L x 4.0"W x 2.0"D)
Black	CVSUPL2965B
Green	CVSUPL2965G
Tan	CVSUPL2965T
Urban Gray	CVSUPL2965U
Red w/ Black Trim	CVSUPL2965R
Digital Camo	CVSUPL2965D

- One main zippered compartment
- Two MOLLE straps on the back
- One front zippered compartment
- One quick-flap hook and loop compartment



USA FLAG PATCH - EMBROID	
COLORS	SIZE
	(1.5" x 1.5")
Black	CVUSAE3028B
Red/White/Blue	CVUSAE3028R



FIRST AID PATCH	
COLORS	SIZE
	(1.5" x 1.5")
Black/Red	CVPAID



USA FLAG PATCH - PVC	
COLORS	SIZE
	(1.5" x 1.5")
Black	CVUSAP3029B
Red/White/Blue	CVUSAP3029R





MOLLE HYDRATION BOTTLE POUCH	
COLORS	SIZE
	(7.8"L x 3.5"W x 3.5"D)
Black	CVBP2966B
Green	CVBP2966G
Tan	CVBP2966T
Urban Gray	CVBP2966U
Digital Camo	CVBP2966D

1. Will hold most standard - sized water bottles (up to 33.8 fl. oz.)
2. Two MOLLE straps
3. Bottle compartment size: 8.0" H x 3.3" D



MOLLE HYDRATION BOTTLE CARRIER	
COLORS	SIZE
	(10.0"L x 4.0"W x 4.0"D)
Black	CVWBC2948B
Green	CVWBC2948G
Tan	CVWBC2948T
Urban Gray	CVWBC2948U
Digital Camo	CVWBC2948D

1. MOLLE hydration bottle carrier will hold up to a 32 oz. bottle
2. Zippered top lid
3. Two MOLLE straps
4. Bottle compartment size: 10.0" H x 4.0"D
5. Includes adjustable carry strap



GUNSMITH APRON	
COLORS	SIZE
	(30.0"L x 28.0"W x 0.3"D)
Black	CAPR2936B
Tan	CAPR2936T
Urban Gray	CAPR2936U
Digital Camo	CAPR2936D

1. Adjustable 33" neck strap
2. Adjustable waist with quick snap buckle fits up to 50" waist
3. Front panel size: 30" Tall x 28" width



EXPERT APRON	
COLORS	SIZE
	(30.0"L x 28.0"W x 0.3"D)
Black	CAPRX2980B
Green	CAPRX2980G
Tan	CAPRX2980T
Urban Gray	CAPRX2980U

1. Adjustable 33" neck strap
2. Adjustable waist with quick snap buckle fits up to 50" waist
3. Front panel size: 30" Tall x 28" width
4. 2.5" H x 7.75" W loop fastener patch near the top for customizing your apron and for attaching hook fastener name tape.
5. Two deep side pockets on each side

1ST RESPONDER GEAR



*SHEARS AND TOURNIQUET NOT INCLUDED

TOURNIQUET AND TRAUMA SHEARS POUCH	
COLORS	SIZE
	(7.0"L x 2.0"W x 1.2"D)
Black	CVTQ2990B
Green	CVTQ2990G
Tan	CVTQ2990T
Urban Gray	CVTQ2990U
Red w/ Black Trim	CVTQ2990R

- This pouch will fit most popular tourniquets
- Elastic sides to conform to the different thickness of tourniquets
- Features a hook and loop fastener flap, with "TQ" embroidered on the front
- The pouch features multiple MOLLE straps (both vertical and horizontal) on the back to mount onto compatible gear
- Rear pocket for trauma shears with hook and loop straps



*TOURNIQUET NOT INCLUDED

MOLLE TOURNIQUET WITH ELASTIC FLAP	
COLORS	SIZE
	(5.25"L X 1.9"W X 0.9"D)
Black	CVTQ3020B
Green	CVTQ3020G
Tan	CVTQ3020T
Urban Gray	CVTQ3020U
Red	CVTQ3020R

- Tourniquet Pouch with elastic hood and MOLLE compatible strap.
- Elastic hood with red embroidered "TQ" to conform to and secures the tourniquet in the pouch. Access to tourniquet is just a simple pull on the elastic hood tab and stretching over the top of the tourniquet for easy access.
- This pouch will fit most of the popular tourniquets out in the marketplace.
- Vertical MOLLE strap with metal button snap to mount onto PAL webbing.
- Two horizontal straps with metal button snaps for horizontal mounting of the pouch onto MOLLE compatible gear or on a belt. It will accommodate 1.5" belts/webbing.



INCLUDES EVERYTHING YOU SEE HERE!



One compact wound seal
One mini compression bandage



One TK-4L tourniquet



One primed compressed gauze



COMPACT TRAUMA KIT	
COLORS	SIZE
	(5.5"L x 4.0"W x 2.0"D)
Black	C1RTK1B-A
Green	C1RTK1G-A
Tan	C1RTK1T-A
Urban Gray	C1RTK1U-A
Red w/ Black Trim	C1RTK1R-A
Digital Camo	C1RTK1D-A

*NcSTAR® accepts no liability whatsoever for the safety, reliability, durability and performance of any of the above products.

One pair nitrile gloves



MOLLE EMT POUCH

COLORS		SIZE
		(8.5"L x 7.0"W x 3.5"D)
	Black	CVEMT2970B
	Green	CVEMT2970G
	Tan	CVEMT2970T
	Urban Gray	CVEMT2970U
	Red w/ Black Trim	CVEMT2970R
	Woodland Camo	CVEMT2970WC
	Digital Camo	CVEMT2970D



CONTENTS NOT INCLUDED

- Unfolds flat into 3 panels



The MOLLE base has hook and loop fasteners that allow you to pull/rip the main pouch away from the MOLLE base in case of an emergency.

Two MOLLE straps to attach to compatible gear.



SMALL MOLLE EMT POUCH





COLORS		SIZE
		(6.5"L x 4.5"W x 2.8"D)
	Black	CVSEMT2988B
	Green	CVSEMT2988G
	Tan	CVSEMT2988T
	Red w/ Black Trim	CVSEMT2988R



- Two MOLLE straps to attach to compatible gear.
- The MOLLE base has hook and loop fasteners that allow you to pull/rip the main pouch away from the MOLLE base in case of an emergency.
- Unfolds into 2 panels for easy access to your first aid supplies

PPE GLOVE POUCH

NEW

COLORS		SIZE
		(4.4"L x 3.0"W x 2.3"D)
	Black	CVPPE3036B
	Green	CVPPE3036G
	Tan	CVPPE3036T
	Red w/ Black Trim	CVPPE3036R



- Top zippered main compartment for easy loading pouch of PPE Gloves.
- Dual elastic overlapping front flaps for accessing PPE glove dispenser.
- Two PALS straps to attach to MOLLE compatible gear.

ORYX TACTICAL BOOTS

ORYX

TACTICAL BOOTS



BLACK BOOTS ARE CONSTRUCTED OF A RUGGED FULL GRAIN COWHIDE AND NYLON OXFORD.

- The knit fabric inner lining and the nylon oxford upper provide maximum breathability.
- Polyurethane outsole is flexible and lightweight weight while providing superior traction.
- Insole is constructed of breathable hi-poly with EVA cushion supports for incredible comfort.
- Speedlace eyelets allow you to take your high boots on and off easily.



TAN BOOTS ARE CONSTRUCTED OF A DURABLE COMBINATION OF SUPER FIBER AND NYLON OXFORD.

- The knit fabric inner lining and the nylon oxford upper provide maximum breathability.
- Polyurethane outsole is flexible and lightweight weight while providing superior traction.
- Insole is constructed of breathable hi-poly with EVA cushion supports for incredible comfort.
- Speedlace eyelets allow you to take your high boots on and off easily.

ORYX - TACTICAL BOOTS [HIGH]

BLACK

CAB3000BH8 | SIZE: 8
 CAB3000BH9 | SIZE: 9
 CAB3000BH10 | SIZE: 10
 CAB3000BH11 | SIZE: 11
 CAB3000BH12 | SIZE: 12
 CAB3000BH13 | SIZE: 13

TAN

CAB3000TH8 | SIZE: 8
 CAB3000TH9 | SIZE: 9
 CAB3000TH10 | SIZE: 10
 CAB3000TH11 | SIZE: 11
 CAB3000TH12 | SIZE: 12
 CAB3000TH13 | SIZE: 13

ORYX - TACTICAL BOOTS [MID]

BLACK

CAB3001BM8 | SIZE: 8
 CAB3001BM9 | SIZE: 9
 CAB3001BM10 | SIZE: 10
 CAB3001BM11 | SIZE: 11
 CAB3001BM12 | SIZE: 12
 CAB3001BM13 | SIZE: 13

TAN

CAB3001TM8 | SIZE: 8
 CAB3001TM9 | SIZE: 9
 CAB3001TM10 | SIZE: 10
 CAB3001TM11 | SIZE: 11
 CAB3001TM12 | SIZE: 12
 CAB3001TM13 | SIZE: 13

DELTA ZULU



- A . 2-way heavy duty front zipper with wind flap
- B . 2 Mid - chest level zippered pockets
- C . Pit vent zippers

SOFTSHELL JACKET FEATURES



1. Detachable hood with drawstrings
2. 3.2" x 4" shoulder patches
3. Elastic wrist cuffs
4. Forearm zippered pockets

- **OUTER LAYER:** 100% polyester, high density 4- way elastic stretch fabric.
- **INNER LAYER:** Super fine micro fleece

DELTA ZULU SOFTSHELL JACKET

ALL SIZES IN INCHES	S	M	L	XL	2XL	3XL	4XL
SHOULDER	16.5"	18.0"	18.5"	20.0"	20.5"	20.75"	22.0"
CHEST (CIRC.)	21.0 (42.0)	22.0 (44.0)	23.25 (46.5)	24.25 (48.5)	25.5 (51.0)	26.0 (52.0)	26.75 (53.5)
WAIST (CIRC.)	19.5 (39.0)	20.75 (41.5)	21.75 (43.5)	22.0 (44.0)	23.75 (47.5)	24.5 (49.0)	26.0 (52.0)
SLEEVE LENGTH	24.75"	25.0"	25.5"	25.75"	26.5"	26.75"	28.25"

COLORS	S	M	L	XL	2XL	3XL	4XL
Black	CAJ2968BS	CAJ2968BM	CAJ2968BL	CAJ2968BXL	CAJ2968B2XL	CAJ2968B3XL	CAJ2968B4XL
Tan	CAJ2968TS	CAJ2968TM	CAJ2968TL	CAJ2968TXL	CAJ2968T2XL	CAJ2968T3XL	CAJ2968T4XL
Urban Gray	CAJ2968US	CAJ2968UM	CAJ2968UL	CAJ2968UXL	CAJ2968U2XL	CAJ2968U3XL	CAJ2968U4XL
Green	CAJ2968GS	CAJ2968GM	CAJ2968GL	CAJ2968GXL	CAJ2968G2XL	CAJ2968G3XL	CAJ2968G4XL
Blue	CAJ2968NS	CAJ2968NM	CAJ2968NL	CAJ2968NXL	CAJ2968N2XL	CAJ2968N3XL	CAJ2968N4XL

OUTDOOR APPAREL

ALPHA TREKKER

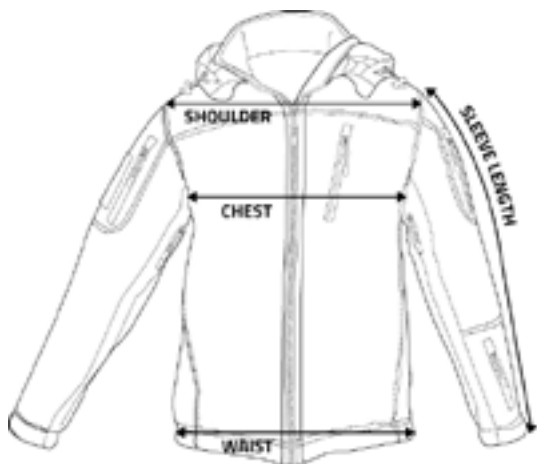

ALPHA TREKKER SOFTSHELL JACKET

ALL SIZES IN INCHES	S	M	L	XL	2XL	3XL	4XL
SHOULDER	16.5"	18.0"	19.0"	19.25"	20.0"	20.75"	22.0"
CHEST (CIRC.)	21.25 (42.5)	22.25 (44.5)	24.0 (48.0)	24.25 (48.5)	25.5 (51.0)	26.0 (52.0)	26.5 (53.0)
WAIST (CIRC.)	19.5 (39.0)	20.75 (41.5)	21.5 (43.0)	22.5 (45.0)	23.0 (46.0)	24.5 (49.0)	25.5 (51.0)
SLEEVE LENGTH	24.75"	25.0"	25.5"	25.75"	26.75"	27.0"	28.0"

COLORS	S	M	L	XL	2XL	3XL	4XL
Black	CAJ2969BS	CAJ2969BM	CAJ2969BL	CAJ2969BXL	CAJ2969B2XL	CAJ2969B3XL	CAJ2969B4XL
Tan	CAJ2969TS	CAJ2969TM	CAJ2969TL	CAJ2969TXL	CAJ2969T2XL	CAJ2969T3XL	CAJ2969T4XL
Urban Gray	CAJ2969US	CAJ2969UM	CAJ2969UL	CAJ2969UXL	CAJ2969U2XL	CAJ2969U3XL	CAJ2969U4XL
Green	CAJ2969GS	CAJ2969GM	CAJ2969GL	CAJ2969GXL	CAJ2969G2XL	CAJ2969G3XL	CAJ2969G4XL
Blue	CAJ2969NS	CAJ2969NM	CAJ2969NL	CAJ2969NXL	CAJ2969N2XL	CAJ2969N3XL	CAJ2969N4XL

- A . 2-way heavy duty front zipper with wind flap
- B . 2 Mid - chest level zippered pockets
- C . Pit vent zippers
- D . 2 lower waist level zippered pockets

SOFTSHELL JACKET FEATURES



1. Detachable hood with drawstrings
2. 3.2" x 4" shoulder patches
3. Elastic wrist cuffs
4. Forearm zippered pockets

- **OUTER LAYER:** 100% polyester, high density 4-way elastic stretch fabric.
- **INNER LAYER:** Super fine micro fleece

OUTDOOR GEAR



*BEVERAGES NOT INCLUDED

- Insulated cooler lunch bag with adjustable shoulder strap and PALS/MOLLE compatible webbing sewn on the back panel of the cooler.
- Foil lined 5mm foam interior will hold up to 12 each 12 oz. soda cans. Cooler lid features a mesh zippered pouch.
- Front zippered pocket 7.5"W X 4.5"H X 1.5"D with hook and loop patch for attaching patches or name tape. Two side mesh pockets with elastic tops 6.0"H X 4.25"H. Adjustable shoulder strap with padded shoulder pad (53" maximum length) with quick connect hooks mounts onto the two plastic D-rings on the sides of the cooler.
- PALS webbing sewn onto the back panel. 4 rows by 4 columns for mounting other MOLLE accessories to the cooler.
- Internal dimensions: 10.0"L X 7.25"D X 7.25"H
- Padded shoulder sling with plastic snap hooks included. Adjustable length from 27" - 51".

INSULATED COOLER LUNCH BAG WITH MOLLE/PAL WEBBING

COLORS		SMALL
		(10.0"L X 7.25"D X 7.25"H)
	Black	CVKOLS3022B
	Tan	CVKOLS3022T



INSULATED COOLER LUNCH BAG WITH MOLLE/PAL WEBBING

COLORS		MEDIUM
		(15.0"L x 9.75"W x 9.0"D)
	Black	CVKOLM3023B
	Tan	CVKOLM3023T

- Front zippered pocket, three mesh pockets, and MOLLE compatible PALS webbing sewn on the back panel of the cooler.
- The cooler's main 19.6 liter compartment and lid is insulated with 5mm foil foam (15.0"L X 10.0"W X 8.0"D) it will hold up alot of food and drinks to keep them cool. Inner main compartment is also lined with a removable sealed plastic liner, secured with hook and loop fasteners, for easy cleaning and to keep cooler dry from melting ice. Cooler lid features a 15.0"L X 10.0"W mesh zippered pouch.
- Front zippered pocket 11.0"W X 5.0"H X 1.0"D with hook and loop patch for attaching patches or name tape. Two side mesh pockets with elastic tops 7.5"H X 6.0"H.
- PALS webbing sewn onto the back panel. 4 rows by 6 columns for mounting other MOLLE accessories to the cooler.
- Internal dimensions: 15.0"L X 10.0"W X 8.0"D
- Adjustable shoulder strap with padded shoulder pad (53" maximum length) with quick connect hooks mounts onto the two plastic D-rings on the sides of the cooler.



ALL PURPOSE SHOPPING BAG

COLORS		SIZE
		(14.3"L x 13.3"W x 6.0"D)
	Black	CSB2997B
	Tan	CSB2997T
	VISM® Camo	CSB2997VC
	VISM® Digital	CSB2997VD

- Large carry 1.5" straps to make carrying a heavy load comfortable.
- Zippered interior pocket for storing small items like coupons, change, keys, etc.
- 5.0"W X 3.0"H loop fastener patch on the outside of the bag for attaching morale patches and name tapes.
- Pocket with clear plastic window for ID or business card.



BIFOLD WALLET



COLORS		SIZE
		(5.6"L x 3.8"W x 0.3"D)
	Black	CAWLT2983B
	Tan	CAWLT2983T
	Urban Gray	CAWLT2983U

- Hook and loop fastener enclosure flap.
- Internally the wallet has 6 separate ID and credit card pockets. Two of the card pockets have clear plastic windows to view ID.
- The wallet also features two compartments for paper currency, receipts, and other documents.
- Externally there are two separate ID and credit/membership card pockets; one card pocket has a clear plastic window.



- Tactical Christmas Stockings for that someone special during the Holidays.
- Side zipper for the main compartment. Plenty of room for the Holiday gifts.
- Plastic clip on the top left corner for hanging your stockings to a nail/screw.
- Bottom plastic clip on the bottom left for clipping something to the stockings.
- Three plastic D-rings on the left side.
- 3.5" X 2" loop fastener for attach hook and loop name tapes & moral patches.
- 3 rows of MOLLE webbing for attaching other MOLLE gear to your stockings.
- 3" X 3.5" front mounted pocket with bungee shock cord closure.
- On the back side of stockings are two PAL straps with metal thumb snaps to connect your stockings to your MOLLE compatible gear.
- Top mounted plastic carry handle.
- Size: 15"H X 10.5" W (Leg = 6.5" W)
- Weight: 6.6 oz.



TACTICAL HOLIDAY STOCKINGS

COLORS	SIZE
	15.0"L x 10.5"W x 0.5"D
 Black	CNSTKG2986B
 Tan	CNSTKG2986T
 Red w/ Black Trim	CNSTKG2986R



- Large main top loading compartment (15.0"H X 10.0"W) with a cinch cord and a plastic clip for hanging.
- Secondary top loading pouch (6.5"H X 5.5"W) under the top hook and loop fastener flap.
- You can also attach morale or name patches to the flap.
- 3 rows of MOLLE PAL webbing for attaching other MOLLE gear to the Holiday Stockings.
- A small mesh pocket 2.75"H X 3.5"W on the bottom side of the Holiday Stockings.
- Toe section of the Holiday Stockings has a loop fastener patch area for attaching hook morale patches.
- Back side of the Holiday Stockings has two MOLLE straps with snap button fastener to attach to other MOLLE gear.
- Size: 15"H X 10.75" W (Leg = 6.5" W)
- Weight: 6.6 oz.

HOLIDAY STOCKINGS

COLORS	SIZE
	15.0"L x 10.75"W x 0.75"D
 Black	CNSTKG2987B
 Tan	CNSTKG2987T