

MUDBOAT®

THE PRO-CAM16

MODEL MUD-MTC200



INFRARED
FLASH

15

SECONDS
TRIGGER
SPEED

50^{FT}

DETECTION
RANGE



EASY
SET-UP

USER MANUAL

R2019.2

ITEMS REQUIRED FOR STARTUP.....	2	ADVANCED SETTINGS	10
FEATURES & SPECS.....	3	MOUNTING & FIELD SETUP.....	16
CAMERA DIAGRAMS.....	4-5	CAMERA CARE	18
BATTERY INSTALLATION.....	6	TROUBLESHOOTING.....	19
MEMORY CARD INSTALLATION.....	8	WARRANTY INFORMATION.....	20
QUICK-START.....	9		

INCLUDES:

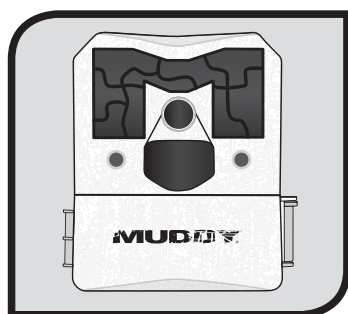

Camera



Manual

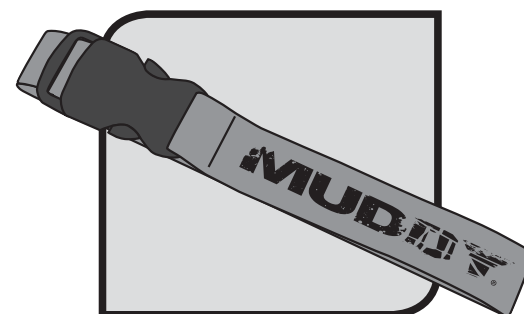

5' Mounting Strap

REQUIRED FOR STARTUP:

- **6-AA Cell Alkaline Batteries** (recommend name brand for best performance, sold separately)
- **1- SDHC Storage Card (Up to 32GB)** (sold separately) The Pro-Cam Trail Cameras require a minimum of 4GB. It is highly recommended to use Class 10 SDHC Cards to provide optimal performance.
- **1- External SDHC memory card reader** for viewing photos/videos (sold separately)

NOTE: 12V DC hookup is available. Both power supply options can be used in combination with each other. If both power supply's are connected, the trail camera will run off of the 12V power before switching over to the 6-AA Cell batteries. The battery indicator will display "EXT" for the power available from the 12V DC option.

FEATURES & SPECS:

Camera Specifications

Image Res.	16 MP	Video Mode	Standard VGA (32 FPS)
Image Detail	Color (Day), B/W (Night)	Video Length	4 Options: 10 - 60 seconds
Illumination	18 LEDs with <u>Infrared Flash</u>	Detection Range	70 Feet
Trigger Speed	1.5 Seconds	Flash Range	50+ Feet
Image Data	Camera ID, Date, Time, Temp, & Moon Phase		
Burst Interval	2 Seconds	Field of View	3 Zone + 50° Detection Angle

Camera Options - Beyond Optimal Presets

Photo Burst	2-6 Photos	Trigger Delay	7 Options: 10 sec-30 Min
-------------	------------	---------------	--------------------------

Physical Specs

Dimensions	4.75" H x 4.25" W x 2.5" D	Settings Screen	LCD Screen
Material	Molded ABS	Mounting Options	Adjustable Strap with Buckle
Finish	Non-reflective Brown	Alt. Mounting	1/4" - 20
Housing	Waterproof	Theft Deterrence	Cable Lock and Padlock Ready

Technical Data

Battery Life	Up to 10,000 Images	Memory Card	Secure Digital Up to 32 GB
Battery Req.	6 AA	Product Warranty	1 Year
Alt. Power	12V DC	Operating Temp.	-10° F to 140° F

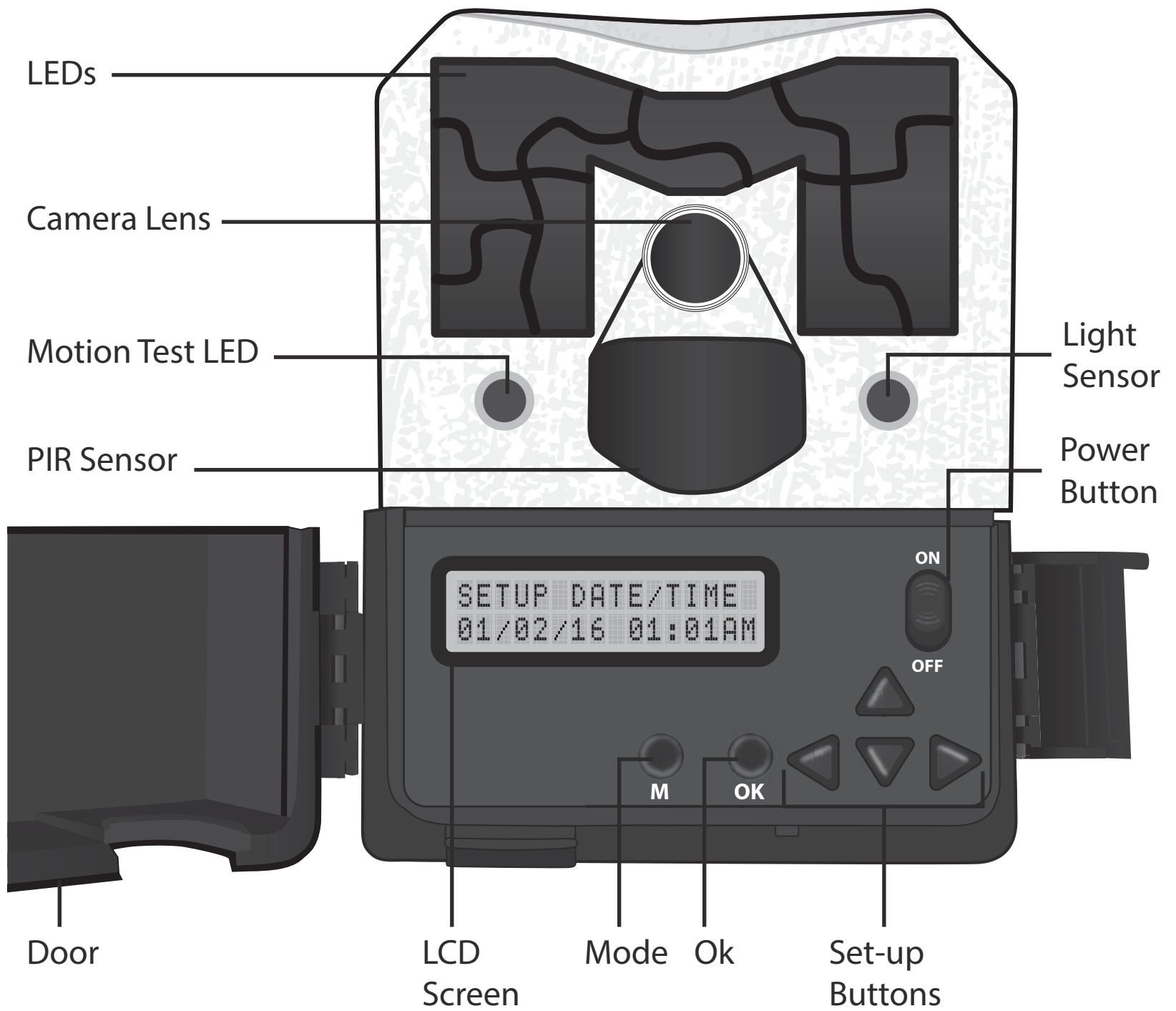

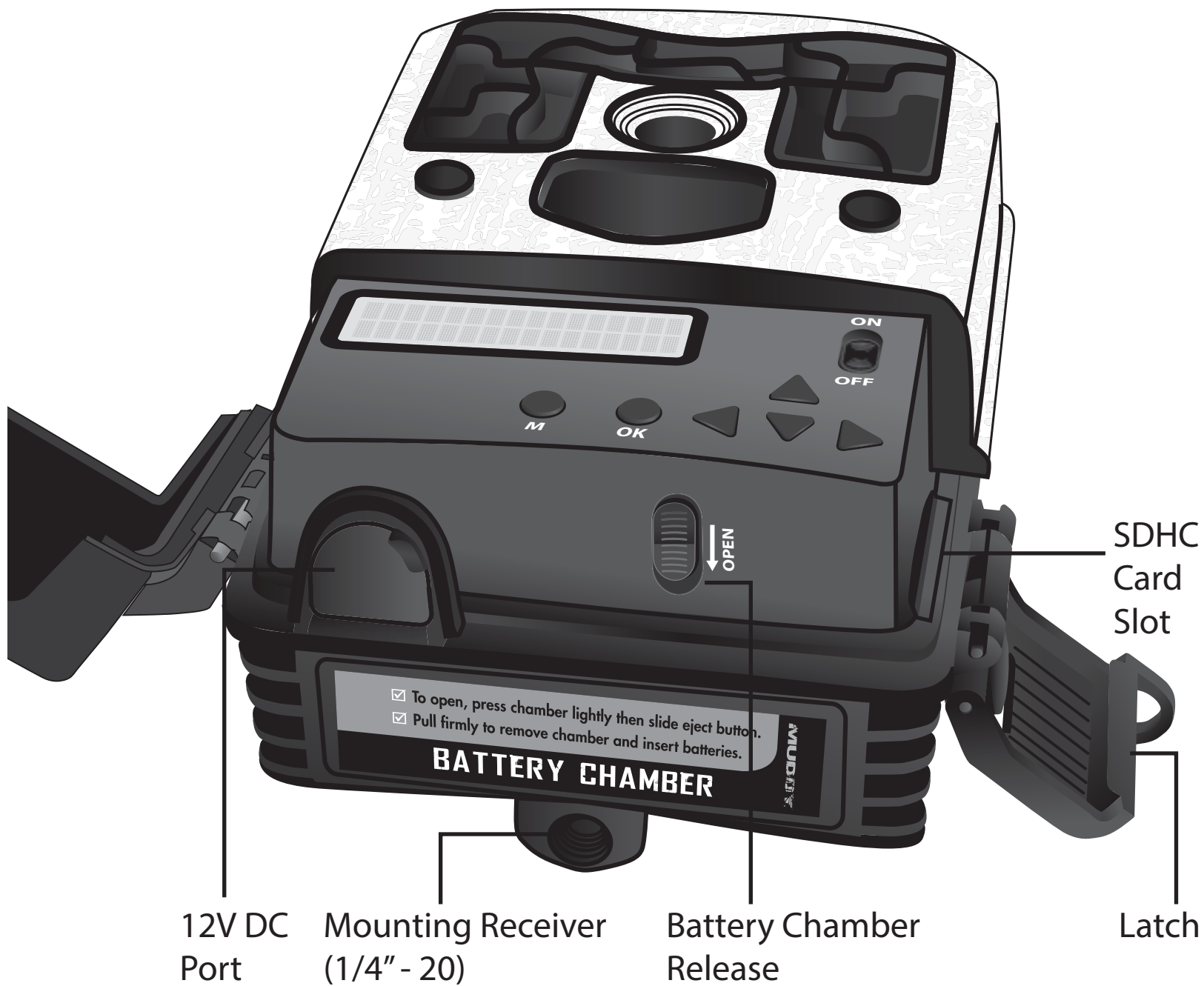

INSTALLING BATTERIES:

IF USING AA - CELL BATTERIES

1. To remove the internal AA battery pack, press chamber lightly and slide the eject/open button inside camera cover (Fig. 1). Next, pull firmly to remove chamber and insert batteries (Fig. 2).
2. Reference the battery icons located on the inside of the chamber compartment. Insert the batteries accordingly as indicated by the positive and negative battery icons (Fig. 3).
3. Slide the battery compartment back into the camera housing until it is completely engaged in the slot in the bottom of the housing (Fig. 4).

NOTE: Installing any of the 6-AA batteries in the wrong direction may cause the batteries to leak acid and could possibly explode, causing camera failure and damage to the battery compartment.

Fig. 1

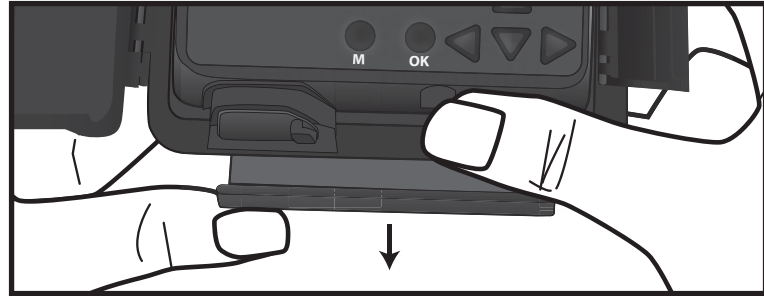

Fig. 2

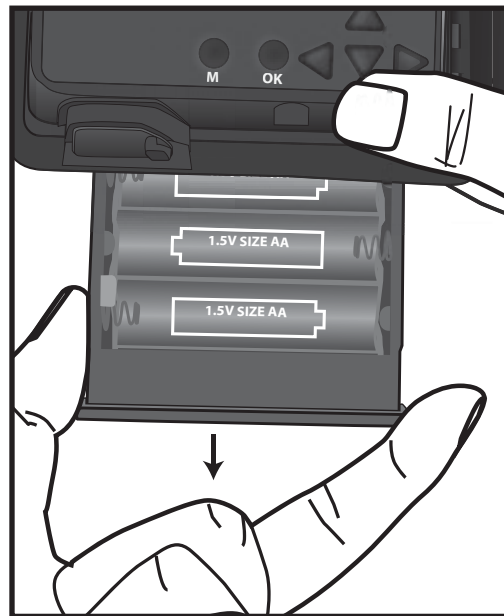

Fig. 3

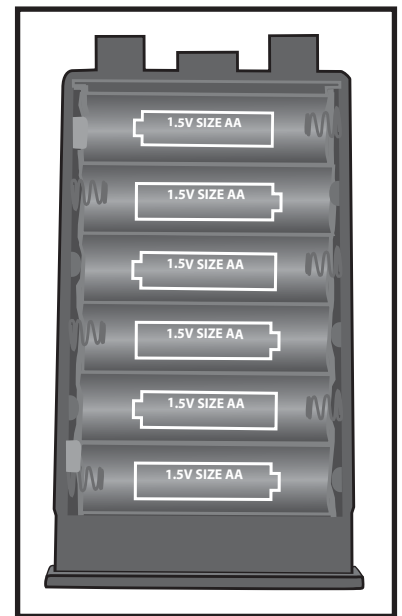
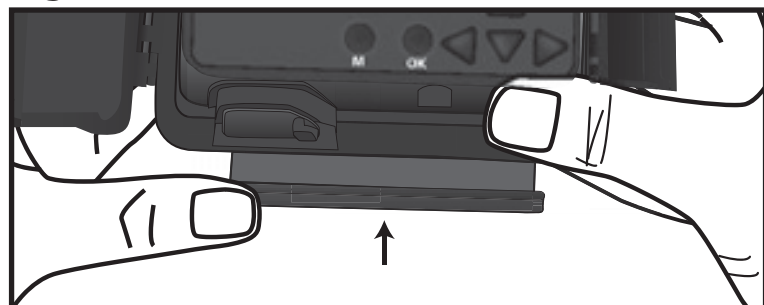

Fig. 4



BATTERIES CONT . . .

IF USING 12V DC POWER SOURCE

1. Remove the rubber port cap at the bottom of the camera (Fig. 1). Using a universal 12V DC cord, plug in to the bottom port option (Fig. 2).
2. Run the cord to the side of the camera where there is a hook provided behind the hinge of the camera door. This will support the power cord and take pressure off of the connection point (Fig. 3).
3. When not in use, replace the rubber port cap at the bottom of the camera to protect the 12V DC universal plug-in port.

Fig. 1

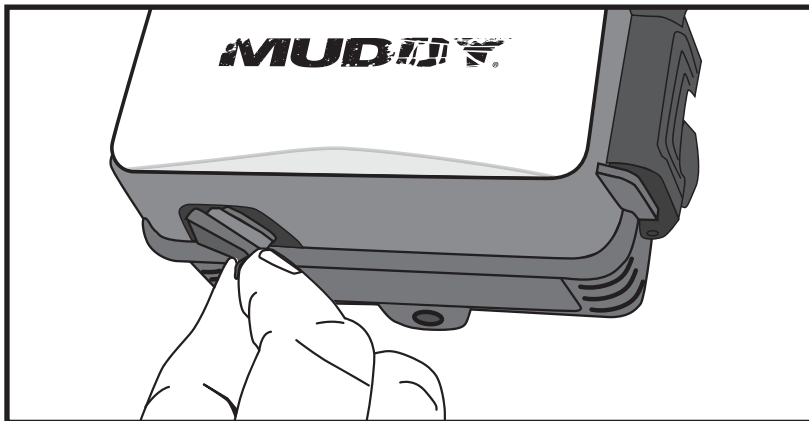

Fig. 2

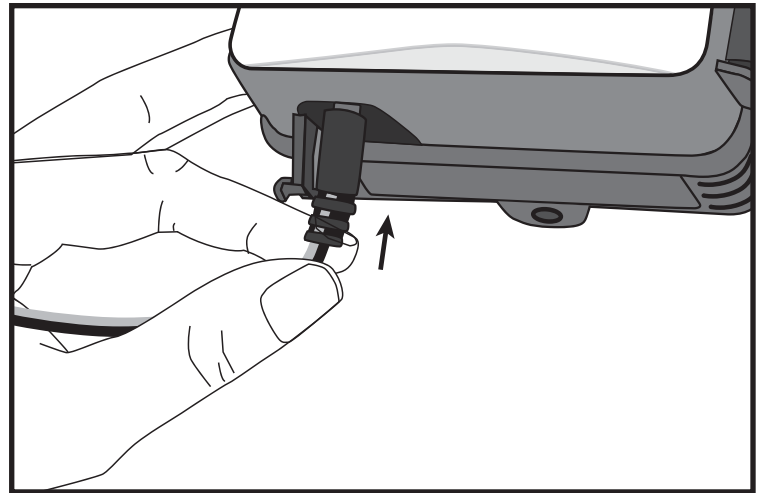
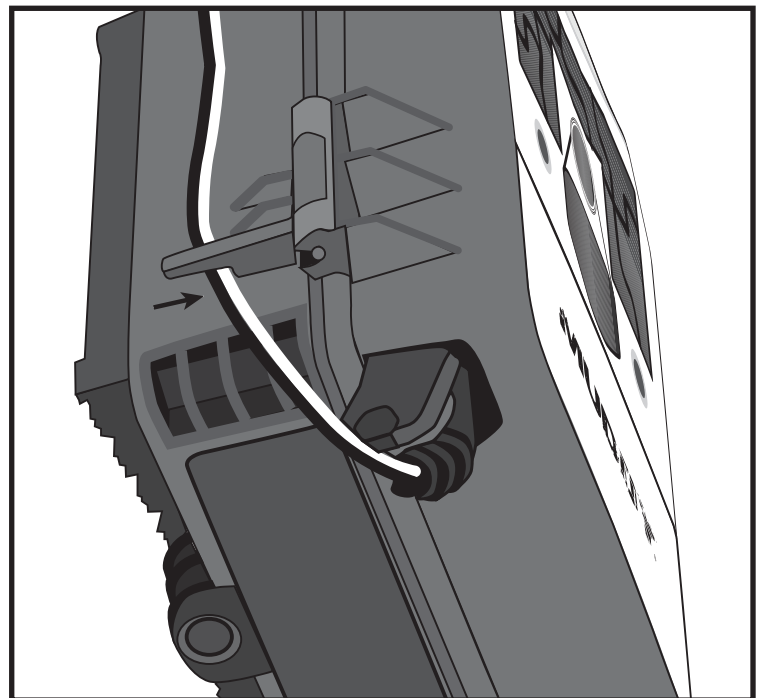

Fig. 3



NOTE: Make sure the camera is **powered off** prior to installing the batteries.

MEMORY CARD INSTALL:

(sold separately)

1. To access the user interface and insert a SDHC Card, lift up on the side locking latch located toward the bottom of the side of the camera. After the latch is disengaged, move latch to allow the interface door to open (Fig. 1).
2. Insert the SDHC card with the contacts facing away. The SDHC card should slide in freely with little resistance. Continue pressing the card inward until you hear a click. This means the SDHC card is locked in place and ready for use. (Fig. 2).
3. To remove SDHC card, press the card inwards to release.

NOTE: We do NOT recommend using cards that came out of a camera from a different manufacturer, or one that has previously been used in a point and shoot camera. Doing so, your Pro-Cam might not be able to accept or read the SDHC Card properly. Use the Format SDHC Card function on the camera for a full format before each use (after you have either copied or reviewed all your photos, see page 17 for reviewing photos), or if any problems occur. Another option is a full format on a PC. Formatting a SDHC card clears file system corruption and erases everything on the SDHC card.

Fig. 1

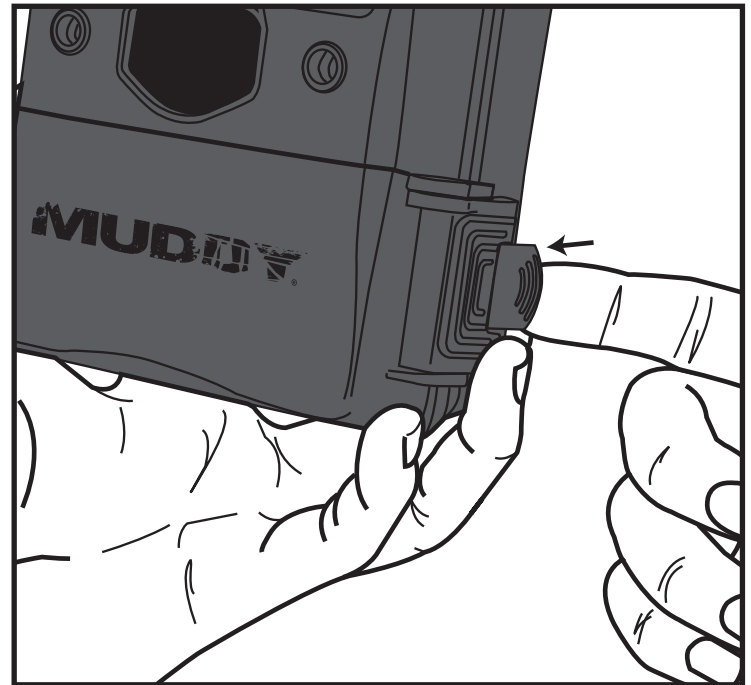
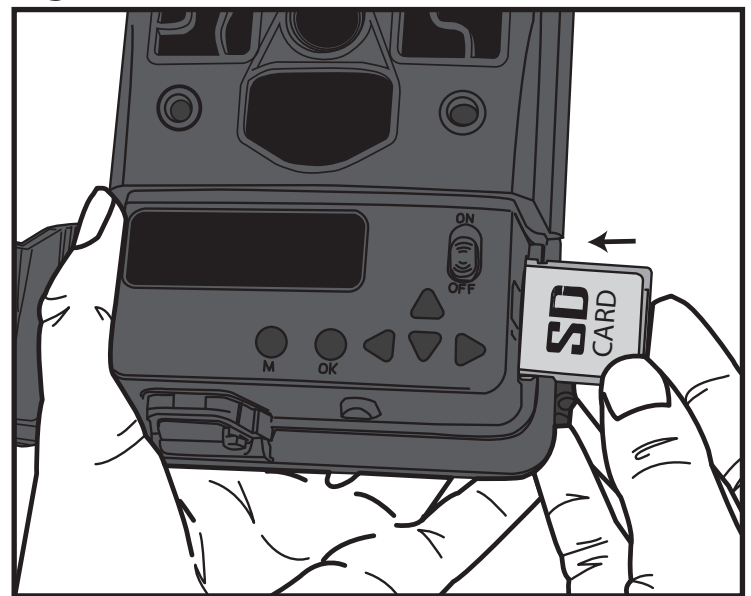

Fig. 2





QUICK-START:

Your Pro-Cam will come with the following standard options already preset. You can leave all settings as defaulted to start taking quality pictures, but you'll want to make sure to set up the current Date and Time.

Setup date/time (Defaults to original date/time – may need to be re-programmed if you reset the default settings)

CAMERA MODE – CAMERA

BURST MODE – 3 PHOTOS

IMAGE QUALITY - HIGH

PICTURE DELAY - 10 SEC

VIDEO LENGTH - 10 SEC

FLASH MODE - AUTO

CAMERA ID - MY CAMERA

TEMPERATURE UNIT - FAHRENHEIT

PICTURE INFO BAR - ON

ADVANCED SETTINGS:

Slide the power button from **OFF** to **ON** position to activate the camera and view the user setup screen.

Setting the functions is easy;

1. Simply press the **M** button to access the menus, and use the **UP** or **DOWN** arrows to scroll through the menu settings.
2. To select the menu setting you want to adjust, press the **OK** button.
3. Make your adjustments, and press **OK** button to accept the settings and change to another menu.

***Note:** any changes you make to settings are not saved until you hit the **OK** button. If you power the camera off prior to hitting the **OK** button, settings will remain unchanged.

TIME AND DATE:

Sets the Date, Year, and Time of day to be imprinted on your photos (not video).

Press the **OK** button for the month setting to flash. Use the **UP** and **DOWN** arrows to change. Press the **LEFT** or **RIGHT** arrows to move to the **DATE** and set this accordingly. Next, press the **LEFT** or **RIGHT** arrows to move to the year and set accordingly. Continue to adjust the hour, minute, and am/ pm on the time. Press the **OK** button when finished, and press the **UP** or **DOWN** arrows to go on to another menu.

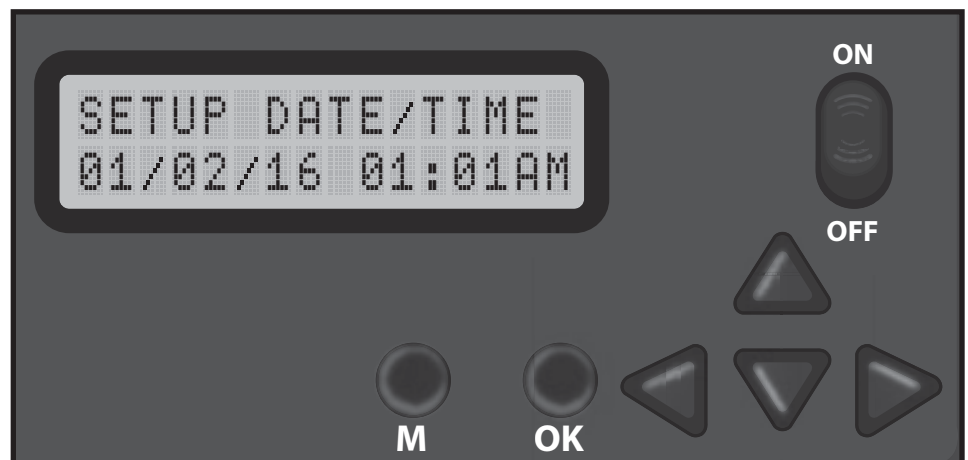

CAMERA MODE:

Sets the camera to take either photos or videos.

CAMERA - The following other settings are recommended to be set when in Camera Mode: Image Resolution, Picture Delay, Burst Mode, Flash Mode

VIDEO - The following other settings are recommended to be set when in Video Mode: Video Quality, Video Length

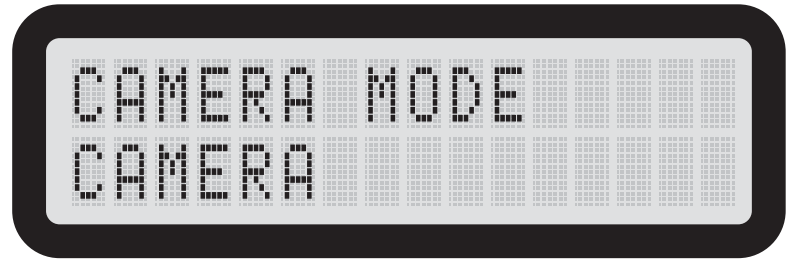

BURST MODE:

Sets how many images the camera will take in a row before the trigger delay kicks in. The amount of time between burst photos is 2 seconds.

Options are: 2–6 photos, OFF

Example: Setting the camera to **3 PHOTO** will give you 3 photos, **2 seconds** apart

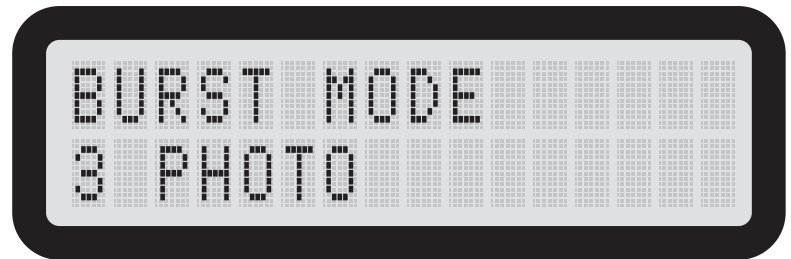
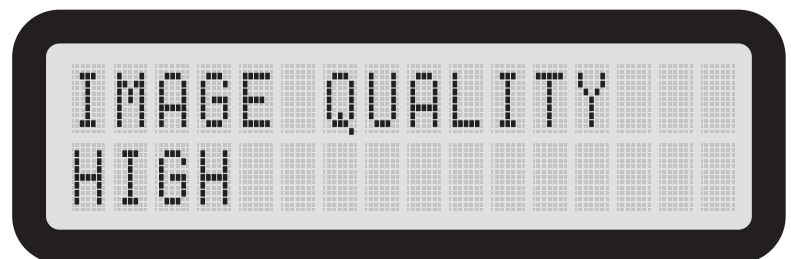

IMAGE QUALITY:

Sets the quality at which you would like the camera to take the pictures. Setting your Pro-Cam to low will allow you to store more images on the SDHC card, at a lower quality. The high setting will allow the highest quality images but requires more storage space.

Options are: HIGH, MEDIUM or LOW



PICTURE DELAY:

Selects the trigger delay at which you want to run your camera. This is the amount of time between each trigger the camera takes.

Options are: 10 sec, 20 sec, 30 sec, 1 min, 5 min, 10 min, 30 min

On a lower setting, the camera will trigger more often than when a higher delay is selected.

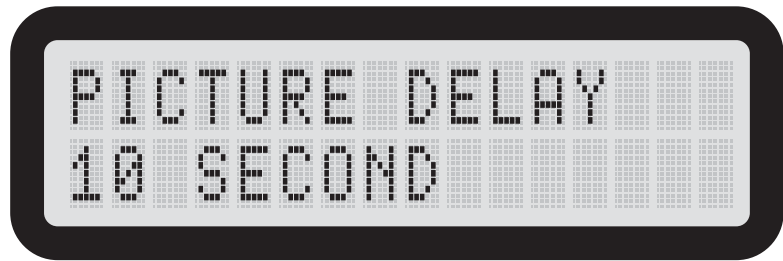

VIDEO LENGTH:

Selects the length you would like each daytime video to be. All night videos are 10 seconds in length, this is to ensure maximum battery life.

Options are: 10 sec, 20 sec, 30 sec, 1 min



FLASH MODE:

Gives you the option to have the camera automatically use the Invisible Flash LEDs when necessary, or off.

Options: AUTO or OFF

Turning the flash mode off will trigger photos during hunting hours only, which can extend your battery life and save storage space.

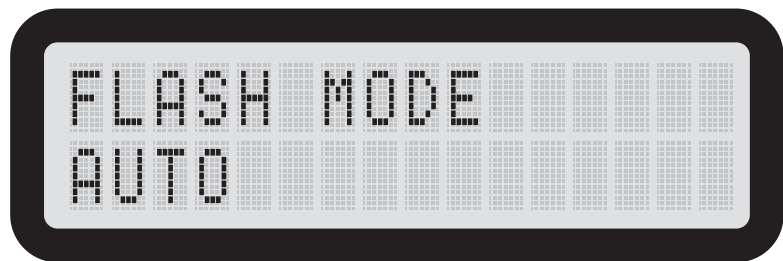

FW VERSION:

Displays the version of firmware that is installed on the camera.

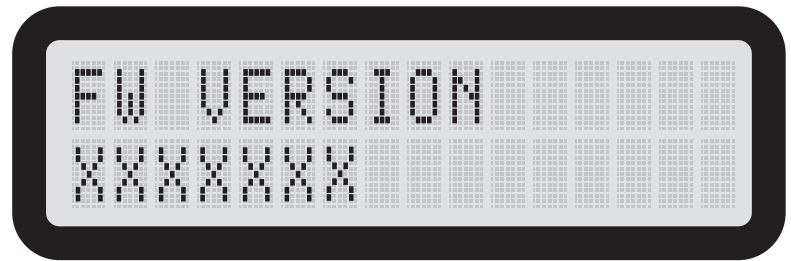

MOTION TEST:

Allows you to determine distance and aim for your detection zone. When this setting is on, you can walk to your target area and move around. The red detection LED will light up when the camera detects you. The camera will arm when it does not detect motion for 30 seconds.

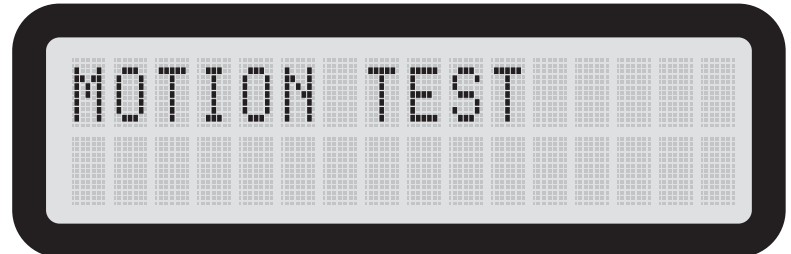

DEFAULT SETTING:

Resets all of the menu settings back to default. Reference page 9 for Quick Start default settings.

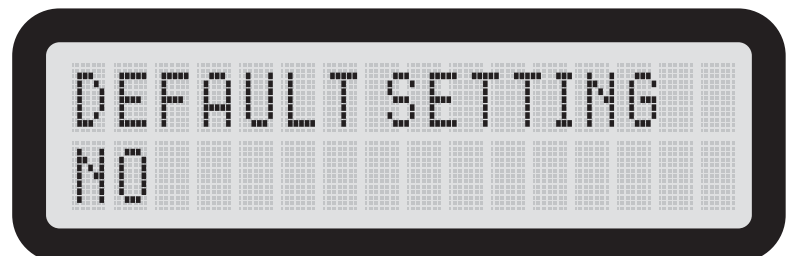

FORMAT SDHC CARD:

Allows you to format your **SDHC Card**. Formatting a SDHC card clears file system corruption and erases everything on the SDHC card. **NOTE:** Before each use, it is highly recommended to either perform a full format on the SDHC Card via a PC, or by performing the Format option on the trail camera.

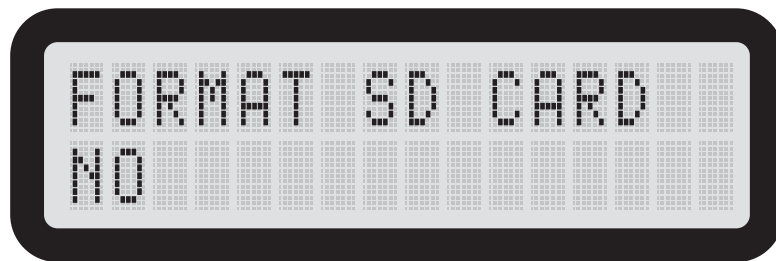

CAMERA ID:

Gives a name to your trail camera that will imprint on the photo files (not video).

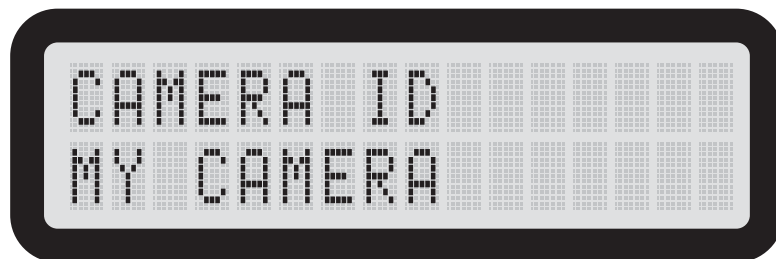

TEMPERATURE UNIT:

Imprints the current temperature on your photo files (not video).

Options: Fahrenheit or Celsius

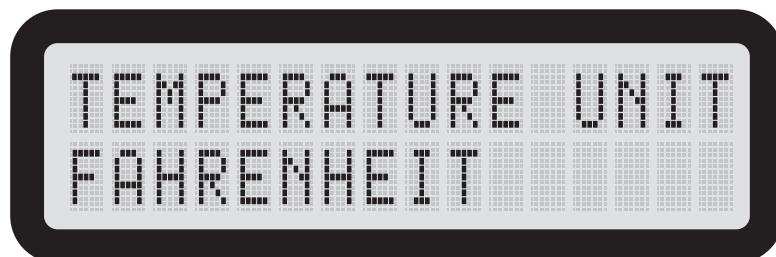

PICTURE INFO BAR:

This setting is only available in Camera Mode, not Video Mode.

It allows you to choose if you want the photos to have the current information imprinted on your files or not.

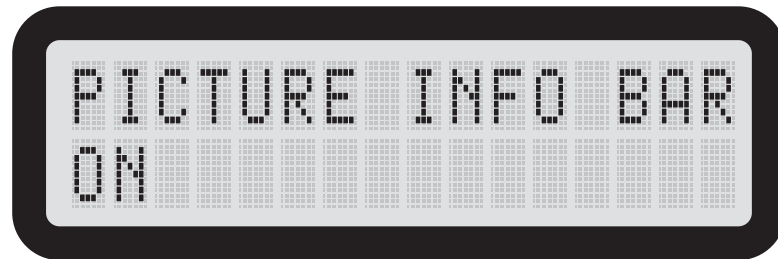

Info included on bar:

CAMERA ID	MOON PHASE	BURST	TEMP	DATE	TIME	MUDBY
S FIELD	<input checked="" type="radio"/>	1-3	015F	12-19-2015	01:09:04 PM	MUDBY

MOUNTING & FIELD SET-UP:

Your Pro-Cam trail camera comes with a 5' nylon mounting strap which allows for quick and easy mounting (Fig. 1). The camera has an open slot on each side of the back for your strap to thread through for mounting. There is also a cable track formed in the back of the camera for additional cable securing (cable sold separately). The bottom of the camera features a 1/4"-20 mount receiver to attach to various mounts using this provision. (Fig. 2). Your Pro-Cam trail camera also has a loop in the latch for padlock security (padlock sold separately) (Fig. 3).

Once you have your trail camera mounted where you want it. Be sure you run the "Motion Test" function on your camera for proper aim and distance. See page 13 for more info.

The motion detection angle of your Pro-Cam trail camera is about 50 degrees, which is slightly wider than the camera Field of View. The motion detection distance in ideal conditions is 50 feet. This can be greatly affected by weather conditions, animal body size, and speed at which an animal passes through the detection zone.

Fig. 1



16

Fig. 2

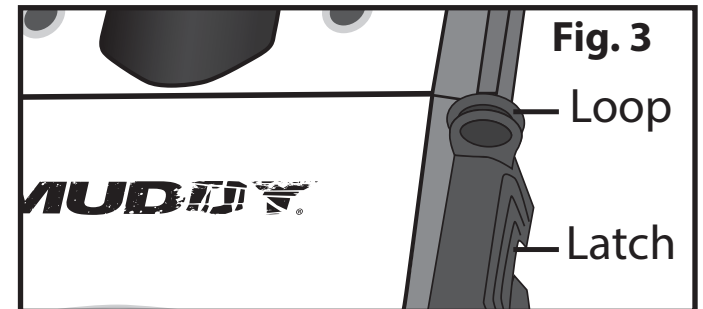
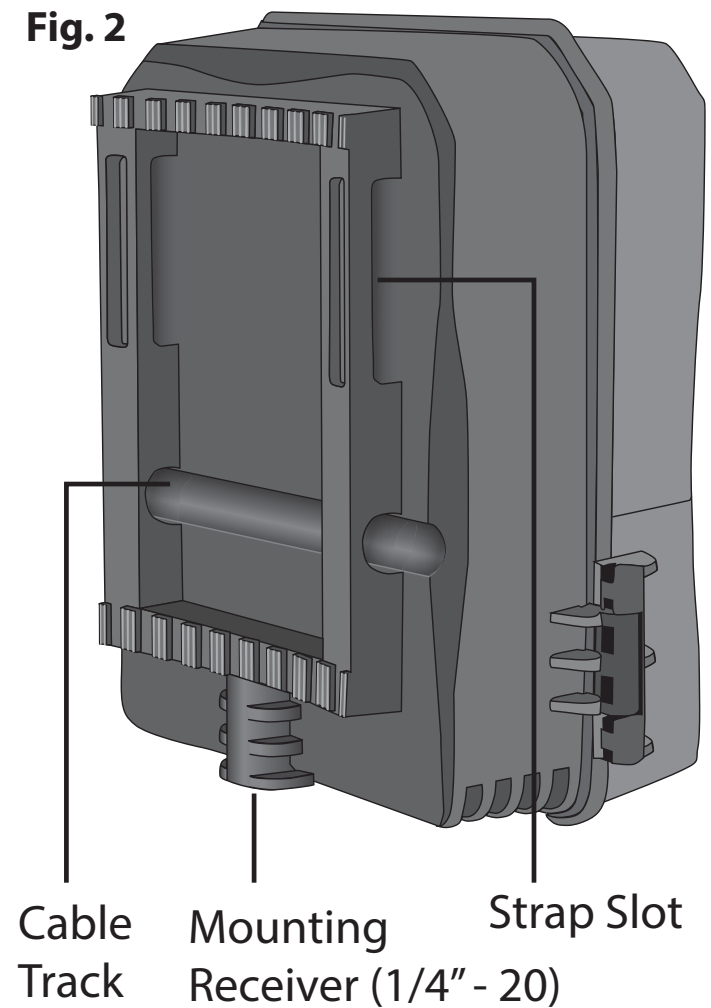

Fig. 3

Loop

Latch

ARMING THE CAMERA:

Your Pro-Cam trail camera will arm itself to take pictures when powered on, with no button activity for 30 seconds, and on the home screen. After 30 seconds, the camera is armed and ready to take pictures. The camera will arm itself in 90 seconds with no activity and in the camera menu.

You can also quickly activate the camera by pressing the RIGHT arrow from the main startup screen. This will start a 3 second delay. At which point, the camera will be armed and ready to take pictures.

REVIEWING IMAGES:

The easiest way to review the images on your SDHC card, is to insert the card into a home computer.

Some computers will have a SDHC slot equipped, where you can directly insert and view the images.

If your computer does not come equipped with an SDHC slot, you will need to purchase an SDHC Card Reader. These are inexpensive, and can be found at your local electronics/hardware store.



CAMERA CARE:

Moisture, vibration, and extreme temperature can cause severe damage to your trail camera and should be avoided. Keeping your camera free from moisture and vibration and using in the correct temperatures will assure you many years of maintenance free service and operation.

MOISTURE:

Although the Pro-Cam trail camera has a very durable waterproof membrane inside the molded ABS material shell, care must be taken to prevent water damage.

- **NEVER** mount your trail camera upside down or leave the case open for an extended period of time.
- **NEVER** change batteries, camera settings, or SDHC Cards in heavy rain.
- If your camera would happen to get water inside, remove the batteries immediately and allow the camera to dry out for several days before activating it.

VIBRATION:

Like any electronic device, your Pro-Cam trail camera is designed with many small electronic components that are very sensitive to vibration. Failure to follow careful handling and transport may cause extreme and irreparable damage to your camera.

- **NEVER** drop the camera on a hard surface
- **ALWAYS** transport your camera in a method to avoid bouncing around or vibration

TEMPERATURE:

Recommended storage and operating temperature: -10°F to 140°F. **NOTE:** Battery life and functions may discontinue or experience shortness in extreme cold/warm temperatures

- **NEVER** store your camera in a vehicle or other contained environment with extremely high temperatures for an extended period of time!

TROUBLESHOOTING:

CAMERA NOT RESPONDING: If your camera at any time does not respond when powered on, or you cannot power it off, your camera may be locked up. The best way to resolve this problem is to remove the AA battery compartment for a period of 10 seconds. This will cut the main power supply to the camera and will take care of the problem. If you are using an alternate power supply, remove any connections for a full 10 seconds.

BAD SDHC CARD: Over time a SDHC or any storage device could become corrupt. If your camera fails to acknowledge the SDHC card, we recommend that you replace the card with a new SDHC card or one from a different MUDDY trail camera that you know works. This will help determine whether the problem is the SDHC card or the camera. We do NOT recommend using cards that have been used in cameras from different manufactures and/or different styles of cameras unless a Full Format on a PC is done to those cards.

NOTE: If you used a Point and Shoot camera to view your pictures and videos on the SDHC Card, this may cause problems when inserted back into your trail camera. It is recommended to do a Full Format on a PC before it goes back into the trail camera.

IMAGE QUALITY: Your Pro-Cam is designed to give you optimum trigger speed, along with great night photo clarity. There may be some instances where an animal is moving extremely fast or light conditions may be insufficient, causing a smearing/blurry object within your image. This is a natural part of photo taking and may occur from time to time.

⚠ WARNING! Prolonged exposure from looking directly into any infrared light could cause cataracts or permanent retinal damage. Do not look directly into the camera during test mode! Failure to follow this warning may cause serious injury or blindness!

⚠ WARNING! Do not expose camera interior components, batteries, or SDHC card to rain or water. Make sure camera and hands are completely dry before handling. Failure to follow this warning may result in serious damage to the camera and/or its parts, personal electrical shock or death!

⚠ WARNING! Only batteries as designated in this manual should be used. Failure to follow this warning may result in leaking batteries, serious damage to the camera, and personal injury or death!

WARRANTY:

WARRANTY

Muddy Pro-Cam Trail Camera's 1 Year Limited Warranty: For a period of 365 days after purchase, GSM, LLC will, at its discretion, repair or replace this product for any reason of any defect or malfunction. This warranty is only valid if the product is used for the purpose intended and has not been tampered with and/or physically damaged in any way. Products that have been damaged due to negligence or misuse do not qualify for warranty replacement. Proof of purchase must be provided to be eligible for warranty.