

Farm Ranch & Pet Products

Since 1941



2020 CATALOG

Miller
Manufacturing
Company



HOT-SHOT



double-Tuf





Miller Manufacturing

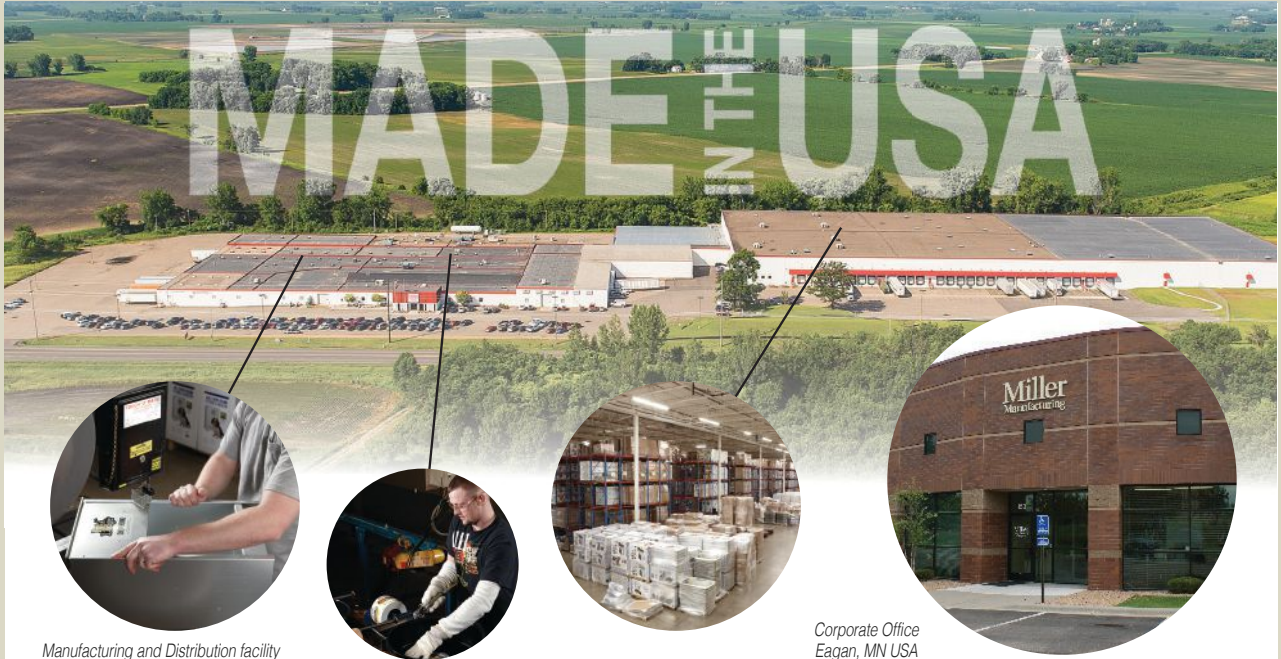

Manufacturing and Distribution facility located in Glencoe, MN USA

Corporate Office Eagan, MN USA

Our Commitment to U.S.A. Manufacturing

We understand the importance of American-made products to farmers, ranchers, and hobbyists. We have been and continue to be committed to United States manufacturing of Miller products for the use in farm and ranch settings. In fact, a number of our farm and ranch products are designed, manufactured or assembled, and distributed in the United States. Miller Manufacturing and our parent company are also committed to U.S. manufacturing, employing over 1,000 U.S. employees.

Although this commitment can and does create challenges in today's economy, we remain committed to delivering reliable, quality products you expect from the U.S. We are also committed to supporting the economy, which is why we maintain our commitment to keeping our manufacturing for a large number of our products right here in the United States.

OUR MISSION

To be a customer-driven manufacturer and distributor of products at the best value for farmers, ranchers, and backyard hobbyists.

OUR GOAL

To be the supplier of choice by providing the freshest, broadest line of cost-competitive, reliable products, on-time and complete.

THE FRANDSEN WAY

From the very beginning, the success of our business has been the result of the behaviors and exceptional efforts of our employees. And at the foundation of our exceptional employees is an extraordinary culture. The 26 "Fundamentals" that follow define our unique culture. They're what set us apart and drive our continued success. We call it The Frandsen Way!

THE 26 FUNDAMENTALS

- HONOR COMMITMENTS.
- BE INTENTIONAL ABOUT RESPONSE TIME.
- LISTEN GENEROUSLY.
- TALK STRAIGHT.
- GET CLEAR ON EXPECTATIONS.
- ASSUME POSITIVE INTENT.
- INVEST IN RELATIONSHIPS.
- OWN IT.
- SAY THANK YOU.
- "BRING IT" EVERY DAY.
- PUT POINTS ON THE BOARD.
- THINK SAFE. WORK SAFE. BE SAFE.
- PRACTICE BLAMELESS PROBLEM SOLVING.
- MANAGE WITH METRICS.
- BE CURIOUS.
- HAVE EACH OTHERS' BACKS.
- FOCUS ON IMPROVEMENT.
- DO THE RIGHT THING ALWAYS.
- GO THE EXTRA MILE.
- EMBRACE CHANGE & GROWTH.
- BE EASY TO WORK WITH.
- LEAD BY EXAMPLE.
- PAY ATTENTION TO THE DETAILS.
- CREATE "WOW" MOMENTS.
- LOOK AHEAD AND ANTICIPATE.
- MAKE IT FUN.



Our efforts to be eco-friendly

We have made it a priority to consider the environment and natural resources in the manufacturing of our products and operation of our facilities, including:

- Use of recycled materials in many of our products
- Utilization of recycled plastic resin
- 100% use of reclaimed rubber
- Utilization of recovered energy sources from our local landfill to power our manufacturing facility
- Investment in energy efficient lighting technologies allowing us to reduce our energy consumption
- Water-soluble machining oil used versus a hazardous waste oil
- Recycling of all manufacturing scrap materials
- This catalog has been printed on FSC certified paper with 10% PCW (post-consumer waste)

New Products5

FARM PRODUCTS

Beekeeping Supplies.....6-12

Woodenware6-7
 Accessories & Tools8
 Beekeeping Books9
 Feeders9
 Feeding & Treating9
 Protective Apparel & Winterizing10
 Honey Production11-12

Maple Syrup Supplies12-15

Bottling12
 Collection Supplies13-14
 How-To Book13
 Testing Equipment15
 Filtering & Sap Funnel15

Feeding & Watering Livestock16-28

Buckets
 Plastic Buckets16
 Wall Brackets17, 23
 Galvanized Pails20-21
 Stainless Steel Dairy Pails21
 Rubber Buckets & Pails22-23

Tubs, Pans & Cans
 Plastic Tubs17
 Flex Tubs17
 Plastic Pans19, 72
 Galvanized Tubs20-21
 Galvanized Garbage Cans21
 Watering Can21
 Rubber Pans & Tubs23, 72

Feeders & Waterers
 Plastic Feeders18
 Plastic Hook Over Feeders18-19, 29
 Metal Feeders22
 Rubber Hook Over Feeder22
 Stock Tanks24
 Float Valves24-25
 Automatic Horse & Stock Waterers25-26
 Feed Scoops26-27
 Hog Feeders28
 Galvanized Feed Pan28
 Mineral & Salt Block Feeders28
 Auger Hoppers28

Nursing Supplies29-30

Baby Pig Waterers & Feeders29
 Nursing Pails29
 Nursing Bottles, Nipples & Accessories30

Stall Supplies.....31-32

DuraFork Stable Cleaners31
 DuraFork Displays31
 Equine Care31
 Muck Cart32
 Totes & Tote Stools32
 Spray Bottles32

Poultry & Game Bird33-45

Galvanized Feeders & Waterers33-35
 Plastic Feeders & Waterers36-40
 Poultry Cup36
 Feeding & Watering Display Kits39
 Automatic Waterer/Fount40-41
 Ceramic Eggs41
 Egg Carton & Flats41
 Egg Baskets41
 Brooder Lamp42
 Brooder Bulbs42
 Brooders42
 Nesting Boxes43
 Restraining Cones43
 Incubators44-45

Pest Control.....46-47

Live Animal Traps46
 Mouse & Rodent Traps47

Fluid Management47

Funnels47
 Oil Pans47

Flooring48-49

Pre-Cut Rubber Utility Mats48
 VersaPad™48
 Trak-Safe Interlocking Mat48
 Rolled Rubber Mats49
 Flooring Displays48-49

RANCH PRODUCTS

Livestock Handling50-54

Electric Livestock Prods50-53
 Power-Mite®52
 Shafts53
 Sorting Poles & Paddles54
 Show Sticks54

SPRINGER MAGRATH®

Springer Magrath®55-57

Livestock Prods55
 FluidFeeders56
 Bolus Gun56
 Cattle Pump System57
 Obstetrical Calf Straps57
 Transfer Needle57
 Orphan-No-More™57

Heated Products

Livestock & Poultry58-61

Heated Buckets & Heaters58-59
 Bucket De-Icers58
 Tank De-Icers / Heaters59-61
 Heater Base61
 Heated Poultry Waterer61
 Heated Poultry Mat61

Hoses & Electrical.....62

Heated Hoses62
 LOCKNDRY® Power Cords62
 ClickShield™ Cord Lock62

Pet & Small Animal Care63-64

Heated Pet Beds63
 Heated Plastic Mats63
 Pet Bed Warmer63
 Heated Pet Bowls64
 Heated Waterers64

Bird Bath & Pond65-68

Heated Bird Baths
 Deck Mount Bird Baths65
 Bird Baths with Stands66
 Decorative Bird Baths66
 Bird Bath De-Icers67
 Water Wigglers®67

Pond Supplies

De-Icers68

Pet Products

Pet Care.....69-75

Exercise Pens69
 Wire Pet Barrier69
 Wire Crates70
 Plastic Trays70
 Plastic Crates71
 Pet Beds71
 Feeders & Waterers72-75
 Pooper Scoopers75

Small Animal Care76-82

Hutches & Homes76-77
 Tools & Accessories78
 Feeders & Waterers79-82

Replacement Parts.....83-85

Item Number / UPC Listing86-91

Double-Tuf®92-97

Container Direct98-99



Understanding Item Listings

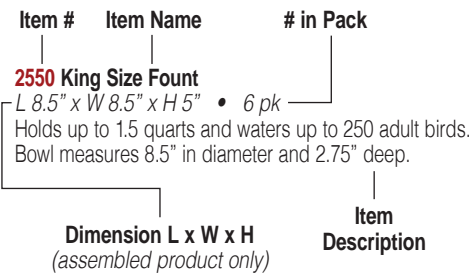

For more information on product carton dimensions and weights see the Miller Manufacturing price list.

Unit Conversion Guide

Capacities of our products are approximate and may vary depending on use.

Length

22 Inches = 55.88 cm.
 24 Inches = 60.96 cm.
 32 Inches = 81.28 cm.
 36 Inches = 91.44 cm.
 42 Inches = 106.68 cm.
 48 Inches = 121.92 cm.
 52 Inches = 132.08 cm.
 60 Inches = 152.4 cm.
 72 Inches = 182.88 cm.

To calculate cubic feet:
L x W x H ÷ 1728

Liquid Measure

8 Ozs = 1 Cup = ½ Pint
 2 Pints = 1 Quart
 2 Quarts = ½ Gallon
 4 Quarts = 1 Gallon
 8 Quarts = 2 Gallons
 12 Quarts = 3 Gallons
 16 Quarts = 4 Gallons
 20 Quarts = 5 Gallons
 26 Quarts = 6 ½ Gallons
 60 Quarts = 15 Gallons
 70 Quarts = 17 ½ Gallons

Dry Measure

2 Pints = 1 Quart
 5 Pints = 2 ½ Quarts
 3 Quarts = 12 Cups
 4 Quarts = 16 Cups
 6 Quarts = 24 Cups

Available Color Swatches

- BERRYBLUE
- BLACK
- BLUE
- BURGUNDY

- GREEN
- HOTPINK
- LIMEGREEN/
APPLEGREEN

- NAVY
- ORANGE
- PURPLE
- RED

- TEAL
- WHITE
- YELLOW

Healthy Growth

Miller Manufacturing is committed to the continued expansion of our product offering through healthy, strategic growth initiatives: developing new products for new markets in new channels through a balance of both organic growth and acquisition.

HEALTHY GROWTH INITIATIVES UNDERWAY INCLUDE:

• Expansion of our Glencoe Distribution Center

- In 2013 we added 24,000 square feet of warehouse space.
- In 2015, we completed adding an additional 96,000 square feet of warehouse space, nearly doubling the size of our Distribution Center.
- In early 2020, we will complete an additional 37,200 square feet to the Distribution Center.

• Investment in New Products

We have a full team of people working specifically to develop new and innovative products. We listen and anticipate our customers' needs, responding by developing products that not only help consumers better care for their animals, but also help our customers to maximize their sales and profits.

• Commitment to American Manufacturing

In our Glencoe facility, we manufacture and distribute the wide breadth of product found in the Miller catalog, including plastic and rubber buckets, galvanized poultry feeders, and both Hot-Shot® and Springer Magrath® livestock prods. Miller employs over 350 people, all working in the United States to bring quality American-made products to the market.



New Products

At Miller Manufacturing, we strive to consistently integrate the legacy of our brands with the innovation of new products for the Farm, Ranch, and Pet markets. We are always working to improve, innovate, and integrate new and revolutionary products to best serve our customers and consumers.

NEW!



PROSWET25



MITEAWAYP

NEW Packaging!



RUSBHSUS



RUSBSPUS



PSTKR12C



200PPC and 200PPRC

Useful Information

Full Service Marketing Support

You won't go it alone...we're here to support you! We have a full-service Marketing and Sales team ready to help you succeed. Our team can assist you with in-store events, marketing, merchandising support, creating value-added content, and offering training and education for customers and staff. We also have planogram kits available for order, containing everything you need to set an eye-catching display in your store! We have a full library of marketing collateral available to help you promote our products, and we have the capability to create custom pieces of content by request. At Miller Manufacturing, we're proud to be your partner.



Planogram Kits



In-store display signs



Sell Sheets



In-store informational tear-off pads



Beekeeping Supplies

The Little Giant® beekeeping product line consists of top-quality products that are compatible with a wide range of existing products on the market. The Langstroth-design hive and accessories will work for the new hobbyist beekeeper or be compatible with existing products that experienced beekeepers are already working with in their orchards, farms, or gardens.



Woodenware

Little Giant® woodenware products are the foundation for new and experienced beekeepers alike. Made from natural pine, Little Giant® hives, supers, and frames are designed to fit most standard 10-frame Langstroth hives to enable both beginner and established beekeepers to expand their beekeeping hobby. With specially designed features—such as a screened bottom board on the hive and wax-coated foundation installed in the frames—Little Giant® woodenware provides everything needed to raise healthy, thriving hives.



HIVE10



DEEPBOX10



MEDBOX10



HIVE10 10-Frame Complete Hive ★

L 21.875" x W 18.25" x H 14" • 1 pk
Pre-assembled for easy set up and use. The Complete Beehive includes: telescoping outer cover with protective metal layer, vented inner cover, 10-frame 9.5" deep hive body, 9.125" wooden frames with wax-coated black plastic foundation, screened bottom board, mite grid and entrance reducer. Bees and other supplies must be purchased separately.

DEEPBOX10 10-Frame Deep Hive Body ★

L 19.875" x W 16.25" x H 9.5" • 1 pk
Pre-assembled for easy setup and use. Includes ten wooden frames with pre-installed wax-coated black plastic foundation for easy viewing of hive activity. Made of natural pine, the Deep Hive Body can be used as either a Brood Box or Honey Super and is precision-milled for maximum strength. Ready to be added to your hive right out of the box!

MEDBOX10 10-Frame Medium Super ★

L 19.875" x W 16.25" x H 6.5" • 1 pk
Pre-assembled for easy set up and use. Includes ten wooden frames with pre-installed wax-coated natural-colored plastic foundation, preferable for honey harvesting. Made of natural pine, the Medium Super is precision-milled for maximum strength. Ready to be added to your hive right out of the box!



BEGHIVEKIT



BEGHIVEKIT Beginner Hive Kit ☼

L 22" x W 18.5" x H 19.5" • 1 pk
Looking to get into the rewarding hobby of beekeeping? Start here! This Little Giant® Beginner Hive Kit has all the basics to get you started. The Hive comes pre-assembled for easy set up and use. The Beginner Beehive includes: telescoping outer cover, vented inner cover, 10-frame 9.5" deep hive body, 9.125" wooden frames with wax-coated black plastic foundation, solid bottom board and entrance reducer. You also get a smoker, smoker fuel, bee brush, hive tool and frame feeder. Bees and other supplies must be purchased separately.



HIVE10KIT



HIVE10KIT 10-Frame Deluxe Beginner Hive Kit ☼

L 21.875" x W 18.25" x H 14" • 1 pk
This kit contains everything a new beekeeper needs to get started beekeeping in one box! Includes 10-frame Langstroth hive with frames and foundation, screened bottom board with mite grid, gloves, veil, smoker, smoker fuel, bee brush, hive tool, frame feeder and the book *Beekeeping for Dummies*. Bees must be purchased separately.



OUTERCOVER

OUTERCOVER Beehive Outer Cover

L 22" x W 18.625" x H 2.875" • 1 pk

Keep the elements out of your hive with this Little Giant® Outer Cover. Made from durable wood with a weather-resistant aluminum covering. This Outer Cover will fit securely on your 10-frame hive. The cover can slide front to back (telescope) in order to provide more or less ventilation to the hive. Perfect for building your own hive, or as a replacement part for your Little Giant® hive. Can be painted or left natural.



INNERCOVER

INNERCOVER Beehive Inner Cover

L 20" x W 16.4375" x H 0.875" • 1 pk

This Little Giant® Inner Cover provides extra ventilation and fresh air to your hive, as well as an added layer of insulation and protection when placed under an outer cover. And by adding this wooden vented Inner Cover to your 10-frame hive, it prevents your outer cover from being propolized and stuck to the hive body. Made from 3/8" plywood with tongue-and-groove (on both cover and solidboard) framing. Fits on all Little Giant® 10-frame Hives. Can be used with our Little Giant® Bee Escape (sold separately) to easily remove bees from supers at honey-harvesting time.



SCREENBOARD

SCREENBOARD Beehive Screened Bottom Board

L 21.75" x W 16.25" x H 2.875" • 1 pk

The Screened Bottom Board is an important tool when it comes to pest management in beekeeping. Along with a mite grid (included), it allows you to passively control and monitor mite levels and accurately measure the number of mites present in the hive. Using this Little Giant® Screened Bottom Board can help you reduce mites, improve ventilation in your hive, and may increase brood production. This Screened Bottom Board is made of durable pine. Works with all Little Giant® 10-frame Hives.



SOLIDBOARD

SOLIDBOARD Beehive Solid Bottom Board

L 21.875" x W 16.3125" x H 1.8125" • 1 pk

This Little Giant® Solid Bottom Board is made of one piece 1/2" exterior plywood with tongue-and-groove white pine rails. Can be used as an alternative to screened bottom boards in your hive. Makes a durable, stable base for your hive. Can be used with all Little Giant® 10-frame Hives.



DFRBLACK

MFRLITE

DFRBLACK Deep Hive Frames

L 19.25" x W 9.5" x H 6.5" • 1 pk

Made of natural pine and comes with black wax-coated plastic foundation already installed for easy viewing of your hive's brood activity. Ready to be placed in your hive right out of the box!

MFRLITE Medium Hive Frames

L 19.25" x W 6.5" x H 6.5" • 1 pk

Made of natural pine and comes with natural-colored wax-coated plastic foundation already installed. The natural coloring of the foundation is preferable for honey harvesting. Ready to be placed in your hive right out of the box!



FOUNDMED5

FOUNDDEEPS

FOUNDMED5 Medium Foundation (5 per bag)

L 18" x W 6.5" x H 0.625" • 6 pk

Natural-colored plastic foundation coated with beeswax. Ready to install in medium (6.25") frames. More durable than wax foundation.

FOUNDDEEPS Deep Foundation (5 per bag)

L 18" x W 10" x H 0.625" • 6 pk

Black plastic foundation coated with beeswax. Ready to install in Deep (9.125") frames. More durable than wax foundation.



Accessories & Tools

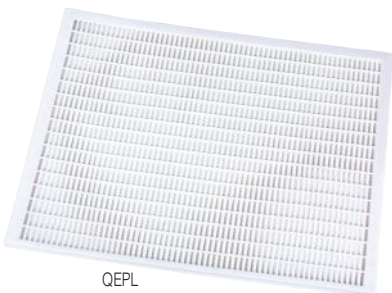

QEPL

QEPL Queen Excluder Plastic

L 20" x W 16.5" x H 0.125" • 6 pk

Designed to fit a 10-frame Langstroth Hive. Prevents the queen from producing brood in the honey supers. Precisely measured holes allow the worker bees to move throughout the hive while preventing the queen from moving upward out of the brood box. Made of injection-molded plastic, the queen excluder is easy-to-clean and lies flat on the brood box.



ESCAPE

ESCAPE Bee Escape, Porter Style (2 per bag)

L 5.25" x W 6.25" x H 0.75" • 6 pk

One-way valve that allows bees to leave but does not allow them back into the hive box. The Bee Escape inserts into the hole in the hive's inner cover to aid in clearing the super of bees so it will be ready for honey harvesting. Made of lightweight, durable plastic.

HIVEPLUG

Beehive Hole Plug (6 per bag)

L 5.25" x W 6.5" x H 0.5" • 6 pk

Many beekeepers in northern climates drill a hole in their hive bodies to aid in ventilation and provide an entrance when snow banks grow. This simple 1" plug will allow you to close or open the hole when the season dictates. Each plug fits a 1" diam. hole.



HIVEPLUG



ENTREDCR

ENTREDCR Beehive Entrance Reducer

L 16.625" x W 3.625" x H 1.125" • 3 pk

This Little Giant® Entrance Reducer will help control ventilation and keep out pesky robbers! Designed to fit a 10-frame Langstroth hive, this reducer will work with either a solid or screened bottom board. Made of natural pine and cut with two notches to provide two different entrance sizes. Simply place the reducer beneath the bottom brood box to create the entrance size desired.



SM7

SM7 4" x 7" Smoker

L 8.5" x W 5.5" x H 11" • 3 pk

Will help to calm your bees when working on your hives. A surrounding wire grid protects you from the heat of the smoker, allowing you to safely smoke your hives throughout your inspection or harvest. A properly packed and lit smoker can last throughout the day.



BEELOG

BEELOG Beehive Log

L 4" x W 7.625" x H 0.25" • 6 pk

The Beehive Log will help you keep track of your hives in all weather conditions! Featuring Rite In The Rain® patented water-shedding paper, these notebooks are useable even in the heaviest of rains or the hottest of days. Record and measure all of your hives' most important details. 100 pages.



SMFUEL

SMFUEL Smoker Fuel

L 9.5" x W 6.75" x H 1.5" • 6 pk

This clean, untreated burlap is a favorite material of beekeepers, as it produces a cool, white smoke and is easy to light.



BKBR14

BKBR14 Beekeeping Brush

L 14" x W 3.5" x H 0.5" • 3 pk

Gently removes bees from the frames both during inspections of the hives and during removal of frames for honey extraction. The soft bristles of the brush are specially designed to remove the bees without harm.



FRGRIP

FRGRIP Frame Grip

L 8.25" x W 7" x H 1.625" • 3 pk

Helps with handling beehive frames during inspections and honey harvesting. With its one-handed operation, this frame grip will easily lift and grip frames to pull them from the hive.



HT10

HT10 10" Hive Tool

L 9.5" x W 1.75" x H 1.375" • 6 pk

A must-have for working with your hives. The Little Giant® Hive Tool is a versatile multi-tasker complete with a scraping edge, nail-pulling hole, and an angled end that is designed specifically to fit on a hive frame and help pry it loose.



FRAMEREST

FRAMEREST Metal Frame Holder

L 20" x W 5.5" x H 7.875" • 3 pk

Gives you a helping hand when you're inspecting your hive. This handy Little Giant® Frame Rest provides a secure hold for your frame, keeping it out of your way and off the ground. Easily slides on and off the long side of your hive box and can be used from hive to hive.



How-To Books

BKDUM *Beekeeping for Dummies*

L 9.25" x W 7.375" x H 0.875" • 6 pk

The 4th Edition *Beekeeping for Dummies* by Howland Blackiston is a comprehensive training guide for all things beekeeping. The book will walk you through the tools of beekeeping, the steps necessary to build and maintain your own beehives, and the phases of honey production and extraction. It also provides new information on mites and the causes and effects of Colony Collapse Disorder.

BKBACK *Backyard Beekeeper*

L 8.25" x W 10.19" x H 0.56" • 3 pk

The Backyard Beekeeper by Kim Flottum is the beginner's guide to starting hives in your backyard or garden. Recently revised and expanded, the book presents you not only with the tips and tools of the hobby, but also the information to best prepare your yard or garden for your newest buzzing bees.



BKDUM

BKBACK

BKHOME

BKHOME *Homegrown Honey Bees*

L 9.375" x W 7.375" x H 0.56" • 6 pk

The *Homegrown Honey Bees* book is "an absolute beginner's guide to beekeeping". You'll find everything you need to know about beekeeping inside this helpful book. It covers everything from getting your first package of bees, to harvesting your first batch of honey. Written in easy-to-understand language, with plenty of colorful pictures and detailed information to get you through your first year as a beekeeper.



FRAMEFDR

ENTFDR

BKTFRD2

Feeders

ENTFDR *Entrance Feeder*

L 6.5" x W 4" x H 7.375" • 3 pk

Easy-to-use plastic feeder that will fit directly into the front entrance of your hive. Designed to fit into the large opening of the entrance reducer on our Little Giant® 10-Frame Complete Hive, the feeder allows space for the bees to come and go while nourishing them with a simple syrup when natural food sources are scarce. The base is made of high-impact plastic, and the clear glass jar allows you to see the feed levels without disturbing the bees. Holds approximately 1 quart.

FRAMEFDR *Frame Feeder*

L 19" x W 9" x H 2.25" • 3 pk

Taking the place of one of the frames inside the brood box, the frame feeder holds 3 quarts of syrup. Inner ladders and grooved sides help the bees access the syrup while reducing the risk of drowning.

BKTFRD2 *2 Gallon Bucket Feeder*

L 10.5" x W 10.5" x H 7.5" • 3 pk

Easy-to-use design helps protect syrup from robbers to keep your bees fed when outside nectar sources are scarce. Fits atop the hole on your inner cover to allow bees access to the syrup. Tiny holes in the lid give bees access to syrup.

Feeding & Treating

BEEFEED *Bee Feeding Stimulant*

L 7.125" x W 4.75" x H 6.5" • 6 pk

Feed your bees! This honeybee feeding stimulant is made up of lemongrass and spearmint essential oils. It helps promote healthy, vigorous hives. Use in late winter and early spring when nectar supply is low. Can also be added to your feeding mix to help build up packages, nucs and swarms. Can also be used in sugar water instead of smoke to calm bees, or sprayed on foundation to help encourage acceptance. Comes in an 8-oz. bottle.

POLLENSUB *Pollen Substitute Powder*

L 12.37" x W 12.25" x H 15.5" • 18 pk

Bee-Pro® pollen substitute contains all the vitamins, minerals, lipids and antioxidants bees need to produce food for their larvae. This high-protein substitute can be used for building colonies in late winter or early spring, to prepare for pollination and to maintain or increase brood production prior to and after honey flow. Free of all contaminants and contains no natural pollen, as natural pollen may still contain pesticide residue and disease-carrying bacteria. Can be fed dry in a feeder box, or made into pollen patties. Comes in a 1-lb. canister.

NEW! MITEAWAYP *Mite Away Quick Strips® Pouch*

L 11.75" x W 7.75" x 1" H • 15 pk

This popular mite treatment kills adult Varroa mites and up to 95% of the Varroa under the cappings. The core of Mite-Away Quick Strips® is a plant-based gel which contains formic acid. The strip is thinner than the height of a bee so it fits in the bee space between hive parts, making it easy to apply. Two strips per hive are recommended. Four strips per package.

NEW! PROSWEET25 *Pro-Sweet Liquid Bee Feed*

L 14.25" x W 9" x H 6" • 1 pk

Give your bees the best! This ready-to-use liquid bee feed has both binomial (bees treat these like nectar) and monomial (bees treat these like honey) sugars, so it stimulates the bees and helps them put on weight. No mixing necessary, and Pro-Sweet won't crystallize or ferment like sugar water. Feed any time. For oral honey bee use only, not for human consumption. Store tightly sealed in a cool dry place. Contains 2.5 gallons.



BEEFEED

POLLENSUB



MITEAWAYP



PROSWEET25



Protective Apparel



JKTM / JKTLG / JKTXL / JKT2XL

JKTM/JKTLG/JKTXL/JKT2XL Deluxe Beekeeping Jacket in 4 Sizes

L 12" x W 13" x H 3" • 3 pk

Made of 50/50 poly-cotton blend, this deluxe jacket comes with a self-supporting domed veil. The veil is attached with a heavy-duty two-way cloth zipper that allows it to be easily removed. The collapsible veil does not need to be fully removed – it can also hang behind like a hood. The jacket features a hook-and-loop patch at the front of the neck opening which secures the veil/jacket connection for extra protection from stray bees.

This jacket is generously cut to allow freedom of movement and includes elastic wrist cuffs and waistband to keep bees out. It features four roomy front pockets that can hold our Little Giant® Bee Log or other items. On each sleeve there is an additional pocket which is the perfect size for a hive tool. A great alternative for someone who does not want to wear a full bee suit when inspecting hives. One jacket and veil per package.



HVEIL

HVEIL Beekeeping Veil with Hat

L 17" x W 20" x H 1" • 3 pk

Will keep you protected while inspecting and working with your hive. The hat and veil's one-piece construction makes this veil a quick grab-and-go option to get out to your hives without any fuss. The hat keeps the veil a proper distance away from your face to prevent bee stings, and there are no seams to inhibit your visibility. Elastic straps fit under arms to secure veil.



TYSUITMD / TYSUIT / TYSUITXL

TYSUITMD Beekeeping Tyvek® Coverall - Medium

TYSUIT Beekeeping Tyvek® Coverall - Large

TYSUITXL Beekeeping Tyvek® Coverall - Extra Large

L 13.5" x W 7.5" x H 1.375" • 3 pk

The full-front zipper closure will keep you protected while caring for your bees. Elastic closures at both the sleeves and ankles will keep out bees. This easy-to-wear suit is water-resistant and disposable.



GLVMD / GLVLG

GLVMD Gloves Goatskin - Medium

GLVLG Gloves Goatskin - Large

L 10.5" x W 6.75" x H 1.375" • 3 pk

Provides dexterity and protection when working with bees. The gloves are complete with elastic cuffs to keep bees out. The soft and pliable goatskin offers superior mobility and flexibility.

Winterizing Accessories

HOTBOX Hot Box® Winterizer

L 20.75" x W 16.25" x H 7.0" • 1 pk

The Hot Box® Hive Winterizer separates the warm air inside the hive from the cold outside air, reducing condensation. Insulation material in the center of the Hot Box® helps retain heat. The included moisture board draws liquid away from the bees and ventilation helps speed up evaporation to keep the bees dry. Includes bee escape holes which are the correct size for bees, but prevent small animals like mice from entering the hive. Made of natural pine. Fits any standard Langstroth Hive. Complete instructions included.



HOTBOX

Moisture board included!



Honey Production

Honey is this hobby's sweetest reward! Little Giant® honey extraction supplies take full frames of honey from hive to honey bear bottle. Designed with the hobbyist in mind, the following honey supplies focus on small batches of honey extraction and bottling for both friends and farmers' markets.

EXT2SS Stainless Steel 2-Frame Extractor

L 30.5" x W 16" x H 16" • 1 pk

This tangential extractor provides the simplicity of a hand-crank extractor and the superior quality of 18/10 stainless steel material. Can be used with either deep or medium frames. Adjustable leg height can easily accommodate a standard 5 gallon bucket. Includes honey gate and cover, some assembly required. Complete instructions included.



EXT2SS



Hand cranks



Fits deep or medium frames



BKT5

BKT5 5 Gallon Plastic Bucket

L 11.875" x W 11.875" x H 14.75" • 3 pk

Comes with a tightly fitting lid and honey gate. Place it under your extractor to collect honey. It can also be used to bring simple syrup to your hives and refill feeders early in the season. Made of HDPE food grade plastic.



HSTRAINSS

HSTRAINSS Honey Strainer - Stainless Steel

L 9.5" x W 10" x H 4.125" • 1 pk

Uses a fine mesh to remove any leftover bits of wax and other particles before bottling. Designed to fit securely over a 5-gallon bucket. Place the strainer under the extractor before bottling.



HFORK

HFORK Uncapping Scratcher Fork

L 8.5" x W 3" x H 1" • 6 pk

Removes any caps leftover from an uncapping knife. Simple to use, the stainless steel points will fit right under the caps to pry them off and allow access to honey for extraction.



HKNIFE

HKNIFE Electric Uncapping Knife

L 18.375" x W 2.75" x H 2.75" • 1 pk

Product is made out of stainless steel and natural pine. Heats up and quickly removes the wax from frames of capped honey. Preset at the appropriate temperature for removal of caps, the heated knife is ready to use within a minute.



HNYGATE

HNYGATE Honey Gate

L 5.25" x W 1.75" x H 5.5" • 6 pk

Made of high-quality plastic and can be used in a variety of different-sized buckets to best suit your needs. It fits through a 1.75" hole and comes with stainless steel hardware to keep it tightly sealed.



HSTRAINIF



Easy to display packaging!

HSTRAINIF Honey Filter

L 5" x W 6.5" x H 0.5" • 3 pk

Designed to be used with a 5-gallon bucket, this fabric strainer fits around the edge of the bucket to filter out pollen, wax and other impurities. The 400-micron washable fabric helps to create fine-filtered honey that has a beautiful appearance and longer shelf life (takes longer to crystallize). 1 filter per package. Use with or without HSTRAINSS.



COLDKNIFE

COLDKNIFE Cold Knife

L 5" x W 17.375" x H 3.375" • 6 pk

This Cold Knife is the fast and easy way to uncapped your frames before honey extraction. No heat required due to sharp edges on blade. Blade can be heated with hot water if desired. The angled-up tip won't catch on your frames during uncapping, and the grooved wooden handle gives you a secure grip. Both edges of the knife are serrated for right or left-hand use.



Honey Production (continued)

Lids Included on All!



HBEAR12

HBEAR12 12 Oz Plastic Bear Bottle

L 7" x W 5" x H 7" • 12 pk

Made of BPA-free PETE plastic. Yellow flip-top lids with built-in freshness and safety seal are included. An area on bear's stomach will hold Little Giant® honey labels (sold separately).

SKEP16 16 Oz (1 lb.) Plastic Squeeze Jar

L 10" x W 4.5" x H 6" • 12 pk

Made of BPA-free PETE plastic. Space is provided on the bottle for Little Giant® honey labels (sold separately). Yellow flip-top lids with built-in freshness and safety seal are included.



SKEP16



HJAR16

HJAR16 16 Oz (1 lb.) Glass Jar

L 13.5" x W 7" x H 6" • 12 pk

This clear bottle in a traditional skep design helps show off your honey. There is room on both sides of the jar for a label. Airtight lids included in the 12-pack carton.

HJAR32 32 Oz (2 lb.) Glass Jar

L 16.5" x W 8.5" x H 7" • 12 pk

This clear bottle in a traditional skep design helps show off your honey. There is room on both sides of the jar for a label. Airtight lids included in the 12-pack carton.



HJAR32



HLABEL

HLABEL Labels for Honey Jars

L 8.5" x W 4.375" x H 0.125" • 12 pk

In order to sell honey and be compliant with federal regulations, each bottle or jar must have a label with the producer's name and the net weight of the honey. These self-adhesive labels make the process quick and easy to get your honey to market! Includes two sizes of labels for different sizes of bottles. 40 labels per package.

*Honey weight is not equivalent to liquid volume.



Maple Syrup

Little Giant® offers a full line of Maple Syrup supplies! Designed just for the hobbyist, this comprehensive line features all the essentials to tap maple trees, harvest the sap and turn it into rich, delicious maple syrup. The spiles, bags and bag holder make collecting sap easy. The hydrometer and cloth sap filter are essential for cooking the sap down to golden maple syrup, and the bottles with our own custom-designed graphics will stand out in the retail space and at the farmers market. This line lets you Tap into a Sweet Tradition®!



Maple Syrup Bottles

MBOTTLEPT 1-pint (16 oz. / 473 mL) Plastic Maple Syrup Bottles

L 10" x W 17.5" x H 3.375" • 6 pk

The perfect storage solution for your delicious maple syrup! The colorful graphics and the classic maple jug shape are sure to stand out on the retail shelf or farmer's market display. Holds 1 pint (16 fl. ozs.) of syrup. Durable plastic construction. Lids with built-in freshness and safety seal are included. 6 bottles per bag.

MBOTTLEQT 1-quart (32 oz. / 946 mL) Plastic Maple Syrup Bottles

L 8" x W 23" x H 4.5" • 6 pk

The perfect storage solution for your delicious maple syrup! The colorful graphics and the classic maple jug shape are sure to stand out on the retail shelf or farmer's market table. Holds 1 quart (32 fl. ozs.) of syrup. Durable plastic construction. Lids with built-in freshness and safety seal are included. 3 bottles per bag.



MBOTTLEQT



MBOTTLEPT



Collection Supplies



BAGHOLDER

BAGHOLDER Sap Bag Holder

L 12" x W 5" x H 2.75" • 3 pk
Offers a secure hold for your sap-collection bags. Durable galvanized metal construction. Designed to keep leaves, bugs and debris out of the sap. Works with other Little Giant® maple syrup products.



SAPBAG

SAPBAG Sap Collection Bag

L 7.25" x W 16.75" x H 0.625" • 6 pk
Sap-collection bags can hold up to 4 gallons of maple sap. They're strong and durable, and the blue color offers additional UV protection while still making it easy to view sap levels. 12 bags per package.

Easy to display packaging!



TREEKIT

TREEKIT One Tree Kit

L 12" x W 5" x H 2.75" • 3 pk
This handy kit includes everything needed to tap just one tree. Ideal for the person who wants to tap one tree but does not want to buy large quantities of supplies. This kit is perfect to get someone started on this hobby! Includes one metal sap bag holder, three plastic sap collection bags and one 5/16" metal spile, along with complete instructions.



BKT3PL

BKT3PL 3 Gallon Plastic Sap Bucket

L 9.5" x W 9.5" x H 12" • 3 pk
This food-grade bucket is made of heat- and UV-stabilized plastic. Easy to clean, this durable bucket is built for many years of use. Translucent design allows for easy viewing of sap level from a distance. Will not rust or corrode.



BKTLD3PL

BKTLD3PL 3 Gallon Plastic Sap Bucket Lid

L 12" x W 12" x H 1" • 3 pk
This food-grade lid for our 3-gallon bucket (BKT3PL) features a stainless steel rod that creates a hinge when paired with our 5/16" plastic spile. Made of heat- and UV-stabilized plastic that is easy to clean and will not rust or corrode.

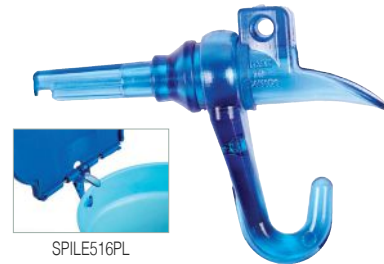

SPILE516PL

SPILE516PL 5/16" Plastic Spile

L 7.5" x W 5" x H 1.5" • 6 pk
This plastic spile is designed to be used with our plastic sap bucket (BKT3PL). The hole in the top of the spile works with the metal hinge on a plastic bucket lid. The metal rod slides through the hole to secure the lid over the bucket. The bucket is hung on the hook, which is strong enough to hold the weight of a 3-gallon bucket full of sap. The smaller 5/16" size is healthier for the tree than 7/16". 10 per package.



BEGMAPKIT

BEGMAPKIT Beginner Maple Syrup Kit

L 12.25" x W 11.75" x H 18" • 1 pk
This kit includes everything needed to tap three maple trees, including three food-grade 3-gallon sap buckets with lids, three plastic spiles and a 30-page *Making Maple Syrup* booklet with complete instructions. An easy way to get started on this great hobby!

Easy to display packaging!



BKM Maple

How-To Book

Explore all things maple in this interesting book by Tim Herd. *Maple Sugar: From Sap to Syrup: The History, Lore and How-To Behind This Sweet Treat* takes you through the entire syrup-making process with colorful pictures and easy-to-read informative text. Learn the fascinating history of maple syrup, how to identify maples in your own backyard, and how to turn clear sap into rich, delicious one-of-a-kind maple syrup. This book also features delicious recipes using real maple syrup. 144 pages.

BKM Maple How To Book, Maple Sugaring

L 6.625" x W 7.5" x H 0.5" • 6 pk



Collection Supplies (continued)

SPILE516 5/16" Metal Spile ✨

L 5" x W 5.5" x H 0.375" • 6 pk
Durable stainless steel spile with 5/16" tap hole for faster tree recovery. Features a washer (11/16" diameter) that will hold a sap-collection bag or bucket (bag/bucket not included). Sanitize at season's end in vigorously boiling water. Sold in packs of 6.



SPILE516

Easy to display packaging!

SPOUT316PL 3/16" Plastic Spout

L 5" x W 5.5" x H 1" • 6 pk
Designed to be used with 3/16" plastic gravity-fed tubing. The barbs on the tube connection arm help eliminate leakage. Can be reused, but we recommend disposing after use to help protect the tree from bacteria each year. 10 per package.



SPOUT316PL

HOOK316PL 3/16" Plastic End Hook

L 5" x W 5.5" x H 1" • 6 pk
Designed to be used with 3/16" plastic gravity-fed tubing. After you run tubing around the last tree you tap, this hook is inserted into the end of the line. Wrap the end of the line back around that tree and use this to hook the line back onto itself and create a dead end. The barbs on tube connection arm help eliminate leakage. 10 per package.



HOOK316PL



TCONN316PL

TCONN316PL 3/16" Plastic Connector

L 5" x W 5.5" x H 1" • 6 pk
Designed to be used with 3/16" plastic gravity-fed tubing. Use to connect multiple tap lines. The barbs on the tube connection arm help eliminate leakage. 10 per package.

TREELOG Tree Tapping Log ✨

L 4" x W 6" x H 0.25" • 6 pk
The Little Giant® tree tapping log will help you keep track of all the important information for each tree you've tapped! Record statistics like the date and time, daytime temperature, first year tapped, tree location, spile size, amount of sap collected and more. Featuring *Rite In The Rain*® patented all-weather paper, this notebook is useable even in rain or snow. Plus, you'll find a handy guide inside to help you identify maple trees in the winter, and identify which trees can be tapped. Inside pages are recyclable. 100 pages.



TREELOG



MBRUSH



MBRUSH Plastic Cleaning Brush

L 5" x W 5" x H 2.75" • 3 pk
Make maple sugaring clean-up easier with this handy brush! The stiff bristles are great for scrubbing sticky sap. The square tip makes it easy to reach into corners of rectangular sap boiling tanks. Made of durable plastic, this is sure to become one of your most useful tools!



BKT5MAPLE

BKT5MAPLE 5-Gallon Plastic Bucket ✨

L 13" x W 13" x H 15.375" • 3 pk
When it's time to make your daily rounds emptying your sap-collection bags, don't forget this food grade 5-gallon bucket. Large 5-gallon (20-quart) capacity, durable plastic construction with a strong metal carrying handle and comfort grip. The included lid keeps out leaves, bugs and other debris.





Testing Equipment

HYDROMETER Hydrometer

L 10.5" x W 0.75" x H 0.75" • 6 pk

Used to measure the density of maple syrup at a specific temperature. To be considered maple syrup, the sap has to be boiled down until it reaches a specific density. A hydrometer is the easiest way to accurately measure the density of your syrup. Features the Baume scale (25-40) and Brix scale (45-75). Made of glass. Designed to be used with the Little Giant® Hydrometer Test Cup (sold separately). Also functions as a candy thermometer. Tested and approved by the state of Vermont.



HYDROMETER



HYDROCUP

HYDROCUP Hydrometer Test Cup

L 8.25" x W 2.75" x H 4.5" • 6 pk

Use this Little Giant® hydrometer test cup along with a hydrometer to test the sugar content of maple syrup. Made from durable stainless steel. Finger loop keeps your hands safe when working with hot syrup.

Sap Filter

MFILTER Cloth Sap Filter

L 8.25" x W 14" x H 1.5" • 6 pk

For crystal clear, golden maple syrup, get this cloth filter. Removes impurities and sediment that can make maple syrup cloudy. Use for filtering sap between cooking pan and final processing pan. Includes one filter.



MPREFILTER

MPREFILTER Maple Syrup Pre Filter

L 6.5" x W 5.25" x H 1.5" • 6 pk

Improve the clarity of your maple syrup by using these pre-filters to remove larger sediment from sap before boiling. This pre-filter will help reduce clogging of the finish filter and help speed up the filtering process. Can be washed and reused several times. One filter per package.



MFILTER

Sap Funnel

The Little Giant® All-Purpose Funnel is great for use throughout the maple sugaring process. Durable food grade polyethylene plastic is safe to use at the high temperature of boiling sap and will not corrode. Designed for use in cold climates, these funnels hold up under tough environmental conditions. Ribbed construction allows air flow for easy pouring. Has built-in hang tab for easy storage.

SAPFUNNEL

2 Quart Plastic Sap Funnel

L 8.5" x W 7.5" x H 7" • 6 pk



SAPFUNNEL



TAPDISP

TAPDISP Tree-Tapping Display

L 49.5" x W 15.75" x H 7" • 1 pk

Everything your customers need for tapping maple trees, all in one space-saving floor display. Features the essential tools for tapping trees, along with our Tree Tapping Log. Compact footprint fits just about anywhere. Ships fully loaded and ready to display. Simply assemble the corrugated base, place the loaded tray on the base, insert the header card and it's ready to go! Unit measures 16" long by 16" wide by 72" high when assembled.

Includes:

- 18 - SPILE516 5/16" Metal Spiles
- 6 - TREELOG Tree Tapping Logs
- 12 - SAPBAG Plastic Sap Bags
- 8 - BAGHOLDER Metal Sap Bag Holders



Farm and Ranch

Our Little Giant® brand provides hobby farmers and ranchers with high-quality, farm-tough products, designed for everyday use in caring for animals. Whether feeding and watering livestock and poultry, beekeeping or general stall maintenance, Little Giant® has the best selection of products to assist with animal care.

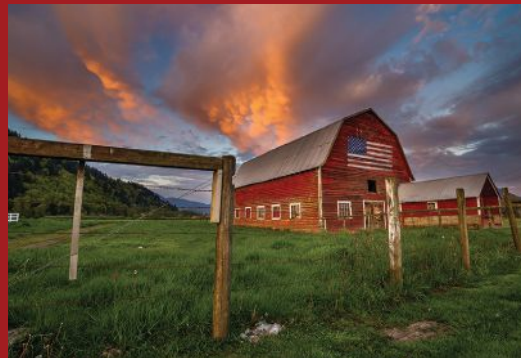

DuraFlex Plastic Buckets

Plastic buckets have always been a favorite around the farm. The flat back fits more compactly against a wall or fence. These buckets really simplify feeding and watering on the farm on daily basis. Buckets are made from polyethylene resin that is impact resistant, protects against warpage and helps prevent stress cracks.



ITEM	DESCRIPTION	SIZE	CASE PACK	COLORS AVAILABLE
P8	8 Quart Plastic Bucket	L 11.5" x W 11.5" x H 8.5"	6 pk	Color swatches: black, blue, green, red, orange, yellow, purple, pink, light blue, white
P8FB	8 Quart Flat Back Plastic Bucket	L 11.5" x W 12" x H 9"	24 pk	Color swatches: black, blue, green, red, orange, yellow, purple, pink, light blue, white
UB10	10 Quart Utility Bucket	L 11.5" x W 11.5" x H 9.44"	12 pk	Color swatches: black, blue, green, red, orange, yellow, purple, pink, light blue, white
P20FB	20 Quart Flat Back Plastic Bucket	L 14.75" x W 14.75" x H 13"	6 pk	Color swatches: black, blue, green, red, orange, yellow, purple, pink, light blue, white
P22FB	22 Quart Flat Back Plastic Bucket	L 15" x W 15.5" x H 12.5"	12 pk	Color swatches: black, blue, green, red, orange, yellow, purple, pink, light blue, white
P24FB	22 Quart Flat Back Plastic Bucket with Knob Bail Attachment	L 14" x W 15.812" x H 12"	12 pk	Color swatches: black, blue, green, red, orange, yellow, purple, pink, light blue, white

Better Bucket®

Patented ergonomically-designed feeder is excellent for horses, cattle and other livestock. Angular design better accommodates animal's facial structure, allowing a more natural eating manner. Tapered sides funnel feed toward back of bucket which makes feed more accessible and reduces animal behavioral or straining concerns.

Flat back provides stability against a wall or fence. Fits on a flat wall with either a traditional wall bracket or snap hook. Durable, impact resistant, high-density polyethylene construction with smooth finished edges and heavy-duty handle.



For best results bucket should be hung.

ITEM	DESCRIPTION	SIZE	CASE PACK	COLORS AVAILABLE
BB10	10 Quart Plastic Better Bucket®	L 17.5" x W 12.5" x H 11"	1 pk	Color swatches: black, blue, green, red, orange, yellow, purple, pink, light blue, white
BB20	20 Quart Plastic Better Bucket®	L 21.75" x W 15.5" x H 13.5"	1 pk	Color swatches: black, blue, green, red, orange, yellow, purple, pink, light blue, white



DuraFlex Plastic Feeders

FF20 20 Quart Fence Feeder

L 14.25" x W 17.5" x H 10.75" • 6 pk
Complete with heavy gauge metal brackets for over-the-fence or on-the-wall installation. Available in: ■ ■ ■ ■ ■

FF11 11" Fence Feeder with Snap Springs

L 11" x W 6.75" x H 6" • 6 pk
Can be mounted to wall instead of using provided clips. Capacity of 4.5 quarts liquid and 4 quarts dry. Available in: ■ ■ ■ ■ ■

FF16 16" Fence Feeder with

Chain & Snap Springs

L 15.75" x W 8.25" x H 7" • 6 pk
Can be mounted to wall instead of using provided clips. Capacity of 9 quarts liquid and 7.75 quarts dry. Available in: ■ ■ ■ ■ ■

MF35BLACK 3.5 Quart Mineral Feeder

L 13.25" x W 6" x H 5.375" • 12 pk
Two compartments for feed, minerals, vitamins, supplements or liquids. Capacity of 3.5 quarts liquid or 3 quarts dry. Available in: ■ ■ ■ ■ ■

FP10GREEN 10 Quart Tire Feeder

L 16.44" x W 16.44" x H 5.88" • 1 pk
Made of tough, impact resistant, high-density polyethylene which protects against warpage, stress cracks and UV damage. Great for feed or water. With smooth edges. Fits inside 13" - 15" tires. Available in: ■ ■ ■ ■ ■

PCF6 26 Quart Corner Feeder

L 25.5" x W 19.5" x H 9.75" • 6 pk
Available in: ■ ■ ■ ■ ■

CF1 Feeder Mounting Ring for PCF6

L 25.125" x W 17" x H 1.875" • 1 pk

CF2 Feed Saver Ring for PCF6

L 22.25" x W 17.25" x H 1.25" • 1 pk

PF25 9 Quart Foal Feeder

L 14" x W 13.75" x H 9" • 1 pk
Adjustable carbon steel bars. Available in: ■ ■ ■ ■ ■



MF35BLACK
3.5 Quarts Liquid/3 Quarts Dry



FF11
4.5 Quarts Liquid/
4 Quarts Dry



FF16
9 Quarts Liquid/
7.75 Quarts Dry



FP20
20 Quart

PF25
9 Quart



FP10GREEN
10 Quart



PCF6
26 Quart
Shown with optional CF1 and
CF2 (sold separately)

DuraFlex Hook Over Feeders

The Hook Over is ideal for the field, pasture, trailer or stall. The durable, molded bracket easily hooks over any "2-by" board to instantly deliver a sturdy feeder or waterer. For more permanent installations simply install two screws in the holes provided.

HF9BLACK 9 Quart Hook Over Goat Trough

L 37.75" x W 8.44" x H 4.72" • 1 pk
Unique design helps reduce feed waste while promoting animal safety and improved health. Universal secure mounting on wire livestock panels or "2-by" board. Galvanized steel grid adds strength and keeps alpha animals from pushing others out while eating. Reinforced hooks provide extra support on ends of feeder. Available in: ■ ■ ■ ■ ■

HF52BLACK 52 Quart Hook Over Trough

L 47.38" x W 13.5" x H 9.56" • 1 pk
Volume for large feeding jobs. Strong hooks fit over most fencing. Reinforced with fiberglass for extra durability. Available in: ■ ■ ■ ■ ■



HF52BLACK
52 Quart



MF6
6 Quart

MF601
Wire grill for plastic
mini-feeder (sold separately)



HFP24D
16 Quart
Brackets adjust
from .25" to 2.25"

HFP24D 24" Plastic Feeder with Divider and Brackets

L 24" x W 9.75" x H 7" • 3 pk
Available in: ■ ■ ■ ■ ■

MF6 6 Quart Plastic Mini-Feeder

L 9.75" x W 11" x H 5.5" • 6 pk
Available in: ■ ■ ■ ■ ■

MF601 Wire Grill for 6 Quart Plastic Mini-Feeder

L 10" x W 11.5" x H 3.75" • 1 pk
Black-powder coated for added rust protection.

CPH 8 Quart Hook Over Feed Pail

L 12.5" x W 11.375" x H 8.5" • 6 pk
Molded bracket fits easily over any "2-by" board to create a sturdy feeder or waterer anywhere. Available in: ■ ■ ■ ■ ■

CPH
8 Quart

HF9BLACK
9 Quart



DuraFlex Hook Over Feeders (Continued)

HF12 12 Quart Fence Feeder
 L 12.125" x W 13.875" x H 14.5" • 6 pk
 Available in

HF15 15 Quart Hook Over Feeder Economy Series
 L 12" x W 13.25" x H 13.25" • 6 pk
 Available in:



DuraFlex Plastic Pans

ITEM	DESCRIPTION	SIZE	CASE PACK	COLORS AVAILABLE
P3	3 Gallon Plastic Utility Pan	L 17.25" x W 17.25" x H 4.5"	12 pk	
P5	5 Quart Plastic Utility Pan	L 11.5" x W 11.5" x H 4"	24 pk	
FP10BLACK	10 Quart Feed Pan	L 18.5" x W 18.5" x H 5.25"	2 pk	
MP10BLACK	10 Quart Mineral/Salt Pan	L 18.5" x W 18.5" x H 5.25"	12 pk	
91BLACK	7 Quart Feed Pan	L 14.25" x W 14.25" x H 4"	36 pk	
PBLP3	3 Gallon Plastic Pan	L 18.5" x W 18.5" x H 4.5"	12 pk	

FP10BLACK
10 Quart

! Features pouring spout and hanging tab.



P3
3 Gallon



91BLACK
7 Quart



P5
5 Quart



MP10BLACK
10 Quart

! Interior ribs lift and position salt block, allowing moisture to escape through drain holes



PBLP3
3 Gallon



FP18
18 Quart

FP18 18 Quart Plastic Feed Pan
 L 18.4" x W 20.5" x H 7.15" • 6 pk

Made of durable high-density polyethylene resin, this feed pan will stand up to tough farm use, indoors and out. Use a spare tire to anchor your feed pan. Available in:

= Made in the USA = Assembled in the USA



Galvanized Pails and Tubs

Heavy-gauge galvanized construction to help prevent rust and corrosion.

ITEM	DESCRIPTION	SIZE	CASE PACK
GP3P	3 Pint Galvanized Pail	L 6.84" x W 6" x H 5.5"	1 pk
GP5	5 Quart Galvanized Dairy Pail	L 10.125" x W 10.625" x H 7.75"	1 pk
GP8	8 Quart Galvanized Dairy Pail	L 11.13" x W 10.25" x H 9.5"	1 pk
GCP8	8 Quart Galvanized Calf Pail	L 11.13" x W 10.25" x H 9.5"	1 pk
GCPH	8 Quart Galvanized Calf Pail Hook Over	L 12.8" x W 10.6" x H 7.73"	1 pk
GP10	10 Quart Galvanized Dairy Pail	L 10.625" x W 10.75" x H 9.625"	1 pk
GP12	12 Quart Galvanized Dairy Pail	L 12.5" x W 11.5" x H 10.84"	1 pk
GP14	14 Quart Galvanized Dairy Pail	L 13" x W 11.75" x H 11.25"	1 pk
GWT425	4.25 Gallon Galvanized Round Tub	L 15" x W 13.13" x H 9"	1 pk
GBT8	8 Gallon Galvanized Bushel Tub	L 18.25" x W 17.5" x H 13.63"	1 pk
GWT1375	13.75 Gallon Galvanized Round Tub	L 22.75" x W 22" x H 13.5"	1 pk
GWT1675	16.75 Gallon Galvanized Round Tub	L 24.5" x W 23.25" x H 13.5"	1 pk



GWT1375
13.75 Gallon



GP14
14 Quart



GWT1675
16.75 Gallon



GBT8
8 Gallon



GP8
8 Quart



GCPH
8 Quart

The strong hook over bracket fits easily over any "2-by" board to create an instant, sturdy calf pail.



GCP8
8 Quart

Valve designed to remove all milk from the bottom of the pail.

Replacement nipple available. Part # DT00238

GP5
5 Quart



GWT425
4.25 Gallon



GP10
10 Quart



GP12
12 Quart



GP3P
3 Pint

Galvanized Oval Tubs

Each features two strong wire handles.

ITEM	DESCRIPTION	SIZE	CASE PACK
GOT2	2 Gallon Galvanized Oval Tub	L 16" x W 9.5" x H 5.5"	1 pk
GOT4	4 Gallon Galvanized Oval Tub	L 19.5" x W 11.25" x H 6"	1 pk
GOT55	5.5 Gallon Galvanized Oval Tub	L 21.5" x W 13.75" x H 7"	1 pk
GOT75	7.5 Gallon Galvanized Oval Tub	L 24.1" x W 12.75" x H 7.3"	1 pk
GOT105	10.5 Gallon Galvanized Oval Tub	L 27.1" x W 15.25" x H 8.3"	1 pk
GOT16	16 Gallon Galvanized Oval Tub	L 31.5" x W 16.9" x H 10.12"	1 pk



GOT75
7.5 Gallon



GOT55
5.5 Gallon



GOT16
16 Gallon



GOT105
10.5 Gallon



GOT4
4 Gallon



GOT2
2 Gallon



Galvanized Round & Square Tubs

Each features two strong wire handles

ITEM	DESCRIPTION	SIZE	CASE PACK
GWT105	10.5 Gallon Galvanized Round Tub	L 20.25" x W 20.125" x H 10.75"	1 pk
GWT15	15 Gallon Galvanized Round Tub	L 22" x W 22.125" x H 11.125"	1 pk
GST16	16 Gallon Galvanized Square Tub	L 20.25" x W 20.125" x H 11.375"	1 pk



GST16
16 Gallon



GWT15
15 Gallon



GWT105
10.5 Gallon



GGC6
6 Gallon
Features
locking lid.

GGC10
10 Gallon
Features
locking lid.



GGC20
20 Gallon



GGC31
31 Gallon

Galvanized Garbage Cans

Galvanized construction to help prevent rust and corrosion. Lid included.

ITEM	DESCRIPTION	SIZE	CASE PACK
GGC6	6 Gallon Garbage Can/Storage Bin	L 13.5" x W 11.75" x H 15.5"	1 pk
GGC10	10 Gallon Garbage Can	L 15.63" x W 15.63" x H 17.75"	1 pk
GGC20	20 Gallon Garbage Can	L 18.88" x W 18.88" x H 24"	1 pk
GGC31	31 Gallon Garbage Can	L 21.75" x W 21.75" x H 27.5"	1 pk



SS9P
9 Quart

SS13P
13 Quart

SS16P
16 Quart

SS20P
20 Quart

Stainless Steel Dairy Pails

Rugged stainless steel is durable and easy to clean. Ideal for farm and ranch. Seamless and sanitary; rust and scratch resistant. Great for distributing feed and water. Heavy-gauge wire handle for easy carrying.

ITEM	DESCRIPTION	SIZE	CASE PACK
SS9P	9 Quart Stainless Steel Dairy Pail	L 12.88" x W 11.25" x H 9"	1 pk
SS13P	13 Quart Stainless Steel Dairy Pail	L 14" x W 12.88" x H 10.5"	1 pk
SS16P	16 Quart Stainless Steel Dairy Pail	L 15.13" x W 13.88" x H 12.38"	1 pk
SS20P	20 Quart Stainless Steel Dairy Pail	L 16.75" x W 15.38" x H 11.5"	1 pk



GWC10
10 Quart

Galvanized Watering Can

Heavy-duty galvanized construction to help prevent rust and corrosion.

GWC10 10 Quart Galvanized Watering Can
L 20.5" x W 9.63" x H 15.25" • 1 pk
Features a gentle flow head.



Metal Feeders

168779 Basic Goat & Sheep Feeder

L 44.5" x W 31.5" x H 45.13" • 1 pk
3" grid helps reduce nearly all forage and hay waste. Research studies show goats eat more easily out of a 4" trough. Ours is specifically designed with this in mind. It is important to keep grain, hay, and forage waste off the ground as goats are close grazers. By using this feeder there is less opportunity for ingestion of parasites. Loose hay and leaves fall into the bunk, not on the ground, for reduced waste and healthier livestock. Holds medium-size square bales. 18" from ground to trough. Accommodates up to 10 mature sheep or goats.



168779



168793

168793 Classic 2-in-1 Feeder

L 21.5" x W 13.06" x H 23.25" • 1 pk
Unique hook over feature allows universal mounting even on hurricane fencing. Keeps grain, hay and forage waste off the ground, reducing opportunity for ingestion of parasites. The compact design of this combination hay and grain feeder saves on space. Accommodates two flakes of hay.

168830 Hay Grazer

L 28.13" x W 13.38" x H 27.88" • 1 pk
Provides a more natural, comfortable way for your horse to feed. Requires horse to eat in a slower, healthier manner; reduces boredom. Keeps hay off the ground, reducing waste and saving you money. Mounts to a fence or wall at ground level. Less dust inhalation for horse. Stores hay in a cleaner, more compact way. Spring-loaded to mimic natural grazing.



168830

DuraFlex Rubber Flat Back Buckets

Little Giant® rubber buckets are tough, pliable, and weatherproof. Our design features a wider opening with convenient stacking lugs so the buckets are easier to stack and separate.

ITEM	DESCRIPTION	SIZE	CASE PACK
DF8FB 8 Quart Rubber Flat Back Bucket	L 11.5" x W 11.75" x H 9.75"12 pk
DF12FB	... 12 Quart Rubber Flat Back Bucket	L 12.75" x W 13.25" H 10.5"12 pk
DF18FB	... 18 Quart Rubber Flat Back Bucket	L 15" x W 15.5" x H 12"12 pk



Graduation marks for easy measuring



Finger grip makes pouring easier

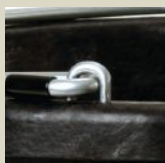

Rugged eyelet and handle connection



DF18FB
18 Quart

DF12FB
12 Quart

DF8FB
8 Quart

Rubber Hook Over

Features molded bracket hooks that easily hook over any "2-by" board. Internal capacity marking shown in quarts and liters.

DF18HF 18 Quart Rubber Hook Over Feeder

L 17" x W 16" x H 10" • 6 pk



DF18HF
18 Quart

DuraFlex Rubber



Molded from the finest corded rubber on the market, nothing matches the pliability and strength of DuraFlex Rubber. Crush-proof, crack-proof, and freeze-proof, you can leave 'em outside year-round!



DuraFlex Rubber Flat Back & Corner Buckets

Flat Back buckets have always been a favorite around the farm. The flat back fits more compactly against a wall or fence and makes hauling heavy loads of water or feed a lot easier.

DFW20 20 Quart Rubber Flat Back Bucket

L 15" x W 15" x H 12.5" • 12 pk

DFC20 5 Gallon Rubber Corner Bucket

L 17" x W 16.75" x H 11" • 6 pk

CB20 Plastic Corner Bracket for DFC20

L 2.25" x W 3.5" x H 8.5" • 1 pk

WB60 Metal Wall Bracket

L 1.185" x W 2.5" x H 7.75" • 1 pk



CB20
Bracket Only
(sold separately)

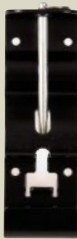

WB60



DFW20
20 Quart



DFC20
5 Gallon

DuraFlex Rubber Pans & Tubs

General purpose pans and tubs. Made of durable and pliable rubber.

ITEM	DESCRIPTION	SIZE	CASE PACK
HP1	2 Qt Rubber Feed Pan	L 8.5" x W 8.5" x H 4"	6 pk
HP2	4 Qt Rubber Feed Pan	L 11" x W 11" x H 4"	6 pk
HP8	8 Qt Rubber Feed Pan	L 14.5" x W 14.5" x H 4.5"	6 pk
HP3	3 Gal Rubber Feed Pan	L 17.5" x W 17.5" x H 4.5"	12 pk
HP650	6.5 Gal Rubber All Purpose Tub	L 18" x W 18.25" x H 8"	6 pk
HP750	6.5 Gal Rubber Feeder Tub w/ Eyelets	L 18.5" x W 19" x H 9"	6 pk
HP15	15 Gal Rubber Heavy Duty Tub	L 26" x W 26" x H 9.75"	3 pk
DF3D	3 Gal Rubber Pan w/ Handles	L 20.25" x W 17.38" x H 6.91"	1 pk
DF650D	6.5 Gal Rubber Pan w/ Handles	L 21.09" x W 18.5" x H 9.84"	1 pk



HP15
15 Gallon



HP3
3 Gallon



Use a spare tire to anchor your pan. HP3 shown (15" tire size)



HP650
6.5 Gallon

HP750
6.5 Gallon

HP1
2 Quart

HP2
4 Quart



HP8
8 Quart

DF3D
3 Gallon



DF650D
6.5 Gallon



DuraFlex Rubber Round Pails

ITEM	DESCRIPTION	SIZE	CASE PACK
DF8	8 Quart Rubber Light Duty Pail	L 11" x W 11.5" x H 9"	12 pk
DF10	10 Quart Rubber All Purpose Pail	L 12" x W 12.75" x H 9.75"	12 pk
DF12	12 Quart Rubber Industrial Pail	L 12.5" x W 12.75" x H 10.5"	12 pk
DFP18	18 Quart Rubber Pail with Pouring Lip	L 15.5" x W 14.5" x H 12.5"	12 pk



DF8
8 Quart



DF10
10 Quart

DF12
12 Quart



DFP18
18 Quart

🇺🇸 = Made in the USA 🇪🇺 = Assembled in the USA



Poly Stock Tanks

Little Giant® Stock Tanks are built tough for superior performance and long-lasting durability. Stock Tanks have many versatile uses in the farm and ranch environment. Available in 5 sizes.

ITEM	DESCRIPTION	SIZE	CASE PACK
ST15	15 Gallon Stock Tank	L 29.75" x W 23" x H 8"	1 pk
ST40	40 Gallon Stock Tank	L 40.25" x W 28.75" x H 13.25"	1 pk
ST75	75 Gallon Stock Tank*	L 48" x W 34" x H 18"	1 pk
ST100	100 Gallon Stock Tank*	L 52.5" x W 37" x H 21"	1 pk
ST150	150 Gallon Stock Tank*	L 62" x W 43" x H 21.125"	1 pk
STKIT	Stock Tank Drain Plug Kit	L 2.2" x W 2.2" x H 1.3"	1 pk

*Includes convenient drain plug (STKIT)

Molded in handle



STKIT
Drain plug (STKIT)
included on ST150,
ST100 and ST75.



See pages 58-61 for winter Stock Tank solutions.

Trough-O-Matic® Automatic Float Valves With Metal Housings

All float valves flow up to 245 gallons per hour and operate between 20-50 psi.

TM830 Trough-O-Matic® Float Valve

L 3" x W 7.5" x H 3.5" • 6 pk
Durable cast aluminum housing with nylon orifice.

TM830T Trough-O-Matic® Float Valve

L 3" x W 7.5" x H 3.5" • 6 pk
Durable cast aluminum housing with nylon orifice. Includes expansion brackets to fit tank rims up to 2" thick and 4.325" wide.

TM830AS Anti-Siphon Trough-O-Matic® Float Valve

L 3" x W 7.5" x H 4.25" • 5 pk
Cast aluminum model that complies with basic back-siphoning regulations. Includes expansion brackets.

Little Giant® Trough-O-Matic® Float Valves automatically control the water level for most stock tanks, troughs, barrels or pans. Each features a 245 gallon-per-hour capacity and accepts standard 3/4" garden hose thread. Each model is manufactured and packaged in the USA by Miller Manufacturing.



TM830



Easy to display packaging!

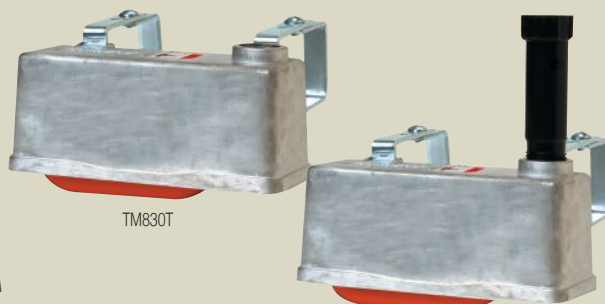

TM830T

TM830AS



Valve close-up



Expansion Brackets



Trough-O-Matic® Automatic Float Valves With Plastic Housings

All float valves flow up to 245 gallons per hour and operate between 20-50 psi.

TM825 Trough-O-Matic® Float Valve

L 3" x W 7.5" x H 3.5" • 6 pk

Popular rugged plastic housing molded from high-impact polystyrene for added strength and durability.

TM825T Trough-O-Matic® Float Valve

L 3" x W 7.5" x H 3.5" • 6 pk

Rugged plastic housing. Includes expansion brackets to fit tank rims up to 2" thick and 4.325" wide.

TM825AS Anti-Siphon Trough-O-Matic® Float Valve

L 3" x W 7.5" x H 4.25" • 5 pk

Popular plastic model that complies with basic back-siphoning regulations. Includes expansion brackets.

Little Giant® Trough-O-Matic® Float Valves automatically control the water level for most stock tanks, troughs, barrels or pans. Each features a 245 gallon-per-hour capacity and accepts standard 3/4" garden hose thread. Each model is manufactured and packaged in the USA by Miller Manufacturing.



Automatic Plastic Horse & Stock Waterers

Includes metal brackets for over-the-fence or on-the-wall installation. Molded from impact-resistant polyethylene resin. Hooks up to 3/4" male garden hose. Operates between 20-50 psi.

FW16MTLBLACK Large Capacity DuraMate Automatic Waterer with Metal Cover

L 17.5" x W 14.25" x H 10.75" • 1 pk

Includes metal float cover and 30" female hose attachment. 16-qt. capacity. Available in: ■

FW16 Large Capacity DuraMate Automatic Waterer with Plastic Cover

L 17.5" x W 14.25" x H 10.75" • 1 pk

Includes 30" female hose attachment. 16-qt. capacity. Available in: ■ ■ ■

89PLW Automatic Waterer 2.75 Quarts

L 10" x W 10.75" x H 5.5" • 1pk

Constructed from durable UV-resistant plastic and will not rust or corrode. Adjustable float control. Can be easily installed at any height using lag bolts or through bolts. Mounting plate is included. Available in: ■



Float-controlled



Over-the-fence



On-the-wall



89PLW



Automatic Metal Horse & Stock Waterers

These all-purpose waterers work well for cattle, hogs, or other outdoor animals. Safely operates between 20-50 psi.

88SW Galvanized Automatic Waterer 2.375 Quarts

L 10" x W 10.75" x H 5.5" • 1 pk

Constructed from heavy gauge, prime draw quality steel. Can be easily installed at any height using lag bolts or U bolts. Will fit a 1/2" pipe with a left or right connection.

88ESW Black Epoxy-Coated Automatic Waterer 2.375 Quarts

L 10" x W 10.75" x H 5.5" • 1 pk

Same as 88SW, yet features a non-toxic black-coated finish.

77 Push Paddle Automatic Waterer 1.09 Quarts

L 10" x W 8.5" x H 5" • 1 pk

Constructed of heavy-duty cast iron with a durable non-toxic black epoxy finish for rust and corrosion resistance, this waterer is designed for tough environments. Comes with two mounting brackets. Features stainless steel, heavy gauge push paddle with locking mechanism and non-siphoning water valve.



88SW
2.375 Quarts



88ESW
2.375 Quarts



77
1.09 Quarts



9203
3 Quart



9206
6 Quart



9204
4 Quart

Galvanized Feed Scoops

Our heavy-gauge galvanized steel scoops feature riveted handles and are perfect for scooping grain or other feed. Product is constructed out of food grade material. Scoop capacities are approximate and may vary depending on material being scooped.

ITEM	DESCRIPTION	SIZE	CASE PACK
9203	3 Quart Galvanized Feed Scoop	L 7" x W 6.5" x H 8.5"	12 pk
9204	4 Quart Galvanized Feed Scoop	L 6.75" x W 7" x H 11.812"	12 pk
9206	6 Quart Galvanized Feed Scoop	L 7" x W 7.25" x H 12.5"	12 pk





Enclosed Feed Scoops

ITEM	DESCRIPTION	SIZE	CASE PACK
153850	3 Quart Plastic Feed Scoop Hotpink	L 6.25" x W 6" x H 9.25"	12 pk
153867	3 Quart Plastic Feed Scoop Yellow	L 6.25" x W 6" x H 9.25"	12 pk
153874	3 Quart Plastic Feed Scoop Limegreen	L 6.25" x W 6" x H 9.25"	12 pk
154116	3 Quart Plastic Feed Scoop Berryblue	L 6.25" x W 6" x H 9.25"	12 pk
150439	3 Quart Plastic Feed Scoop Black	L 6.25" x W 6" x H 9.25"	12 pk
150415	3 Quart Plastic Feed Scoop Blue	L 6.25" x W 6" x H 9.25"	12 pk
150422	3 Quart Plastic Feed Scoop Green	L 6.25" x W 6" x H 9.25"	12 pk
150408	3 Quart Plastic Feed Scoop Red	L 6.25" x W 6" x H 9.25"	12 pk
150446	Enclosed Scoop Asst. Pack	L 6.25" x W 6" x H 9.25"	1 pk 4 color pack includes 3 black, 3 blue, 3 green, 3 red



150408



150446

Plastic Feed Scoops

Our plastic scoops are made of durable food grade polypropylene. Perfect for scooping grain and other feed. Scoop capacities are approximate and may vary depending on material being scooped.

ITEM	DESCRIPTION	SIZE	CASE PACK	COLORS AVAILABLE
89	1 Pint Plastic Feed Scoop	L 9.75" x W 3.5" x H 2.5"	36 pk	<input type="checkbox"/>
90	5 Pint Plastic Feed Scoop	L 15.625" x W 6" x H 3.5"	12 pk	<input type="checkbox"/>



89
1 Pint

90
5 Pint



Hog Feeders

Made of heavy-duty steel. The top door flips open from the back for easy loading. Comes completely assembled.

HGFS Single Door Hog Feeder 50-lb. Capacity

L 19" W 12.75" x H 29.5" • 1 pk

HGFD Double Door Hog Feeder 100-lb. Capacity

L 24.25" x W 19.75" x H 35.75" • 1 pk



HGFD
100 Lb



HGFS
50 Lb



Top door for easy loading

For more Galvanized Pails, Tubs & Feeders see page 20-21



TAP2

Galvanized Feed Pan

This all-purpose utility pan is made of heavy-gauge galvanized steel. Rust-resistant properties make it ideal for outdoor use.

GP13 13 Quart Galvanized Feed Pan

L 16.25" x W 16.25" x H 3.75" • 12 pk



GP13
13 Quart

TAP2 Tap Adaptor

L 4.25" x W 4" x H 1" • 12 pk

Save time, worry, and work with this self-watering device. Attach to standard pipe fitting, turn on the faucet, and your animals will have a tongue-triggered fresh supply of water. Ideal for pigs, goats, sheep and other farm animals.

Mineral & Salt Block Feeders



SBP2

Salt blocks not included.



SB1



SBPU



SBP3
1 Quart



MF1GREEN
1 Quart

SBP2 4-lb. Plastic Salt Block Holder

L 3.75" x W 3.5" x H 5" • 6 pk

Constructed out of durable polyethylene and features pre-drilled holes for easy mounting on most surfaces. Holds most 4-lb. salt blocks. Available in: ■

SB1 4-lb. Salt Block Holder

L 3.125" x W 5" x H 5.625" • 6 pk

Vinyl-dipped for added protection and rust prevention. Holds most 4-lb. salt blocks. Available in: ■

SBPU Universal Block Holder

L 12.63" x W 14.25" x H 9.69" • 1 pk

Unique design allows for feeding protein blocks, salt blocks, loose minerals and feed grain for goats, cattle and equine. Animals cannot gnaw on corners or knock block out of the holder, reducing waste and cost. Universal secure mounting on wire livestock panels or "2-by" board. Available in: ■

SBP3 1 Quart Salt Block Feeder

L 9.31" x W 6.06" x H 5.56" • 1 pk

Feeder holds standard 4-lb. salt or mineral block. Raised ribs and drainage holes keep blocks dry. Contoured mounting plate has holes to allow for permanent mount. Available in: ■

MF1GREEN 1 Quart Mineral Feeder

L 9.19" x W 5.56" x H 5.5" • 1 pk

Simplifies measurement and consumption of multiple minerals. Divider for two types of granular minerals. Pre-drilled mounting holes for easy installation. Available in: ■

Auger Hoppers

Made of low density polyethylene material. Performs well under extreme temperatures and operating conditions. Ultraviolet resistant for long life with exposure to sun light. Durable canvas tension strap with metal buckle included.

DT00102 V Hopper - Standard Size Black

L 46.88" x W 38.5" H 22.5" • 1 pk

DT00104 Large Round Hopper

L 52" x W 48.5" x H 18" • 1 pk

DT00103 Auger Hopper

Replacement Strap • 1 pk

Heavy-duty black canvas tension strap with metal buckle.



DT00102



DT00104



DT00103



Baby Pig Waterers

This watering system has become an industry standard for watering piglets. Ready to use the day after farrowing. This reliable system includes polyethylene jug, durable polystyrene base, and galvanized mounting tray.

BPW4 1 Gallon Baby Pig Waterer ✦
L 6.75" x W 9.5" x H 13.125" • 6 pk



BPW4
1 Gallon



BPF2
7 Lb



BPF3
9 Lb



Baby Pig Feeders

These feeders are constructed out of heavy-gauge galvanized steel and troughs are removable for easy cleaning.

BPF2 2 Hole Feeder - 7-lb. Capacity ✦
L 8" x W 8.25" x H 12.5" • 8 pk

BPF3 3 Hole Feeder - 9-lb. Capacity ✦
L 12" x W 8" x H 12.5" • 6 pk

Calf, Lamb and Goat Pails

CP9 8 Quart Plastic Feed Pail with Metal Hanging Brackets ✦
L 12.5" x W 11.5" x H 7.75" • 5 pk
Great for calving operations. Available in: ■

CPH 8 Quart Hook Over Feed Pail ✦
L 12.5" x W 11.375" x H 8.5" • 6 pk
Bracket easily hooks over any "2-by" board to create a quick and sturdy feed pail anywhere. Available in: ■ ■ ■

CP8 8 Quart Plastic Calf Nursing Pail with Nipple Assembly ✦
L 11.5" x W 11.5" x H 8.375" • 6 pk
Can be hung on fence with included hanging bracket. Available in: ■

GCP8 8 Quart Galvanized Calf Pail
L 11.13" x W 10.25" x H 9.5" • 1 pk
Valve designed to remove all milk from bottom of the pail. Features heavy-gauge wire handle with notch for easy hanging.

GCPH 8 Quart Galvanized Calf Pail Hook Over
L 12.8" x W 10.6" x H 7.73" • 1 pk
The strong hook over bracket fits easily over any "2-by" board to create an instant, sturdy calf pail.



CP9
8 Quart



CP8
8 Quart



CPH
8 Quart



GCP8
8 Quart



GCPH
8 Quart

Replacement parts available. See page 83.

Replacement nipple available. Part # DT00238



Calf, Lamb & Goat Nursing Bottles

Nursing bottles are made of strong and durable FDA-approved polyethylene. Nipples are made from a special rubber formula to prolong nipple life and improve pliability.



9812 2 Quart Nursing Bottle with Snap-On Nipple ✂
L 4.25" x W 4.25" x H 13.25" • 12 pk
Features a high-quality snap-on nipple with vacuum air vent.

9312 2 Quart Nursing Bottle with Screw-On Cap ✂
L 4.25" x W 4.25" x H 13" • 12 pk
Features a screw-on cap and nipple for easy attachment.

98CB 2 Quart Snap-On Nursing Bottle Only ✂
L 4.25" x W 4.25" x H 10" • 12 pk
For use with Snap-on Calf Nipple (98CN).

93CB 2 Quart Screw-On Nursing Bottle Only ✂
L 4.25" x W 4.25" x H 10" • 12 pk
For use with Screw-on Calf Nipple (93SCN).

9813 3 Quart Nursing Bottle with Snap-On Nipple ✂
L 4.1" x W 4.1" x H 17.187" • 12 pk
Features a high quality snap-on nipple with air vent.

9313 3 Quart Nursing Bottle with Screw-On Nipple ✂
L 4.1" x W 4.1" x H 17" • 12 pk
Features a screw-on cap and nipple for easy attachment.

9803CB 3 Quart Snap-On Nursing Bottle Only ✂
L 4.1" x W 4.1" x H 14" • 12 pk
For use with Snap-On Calf Nipple (98CN).

9303CB 3 Quart Screw-On Nursing Bottle Only ✂
L 4.1" x W 4.1" x H 14" • 12 pk
For use with Screw-On Calf Nipple (93SCN).

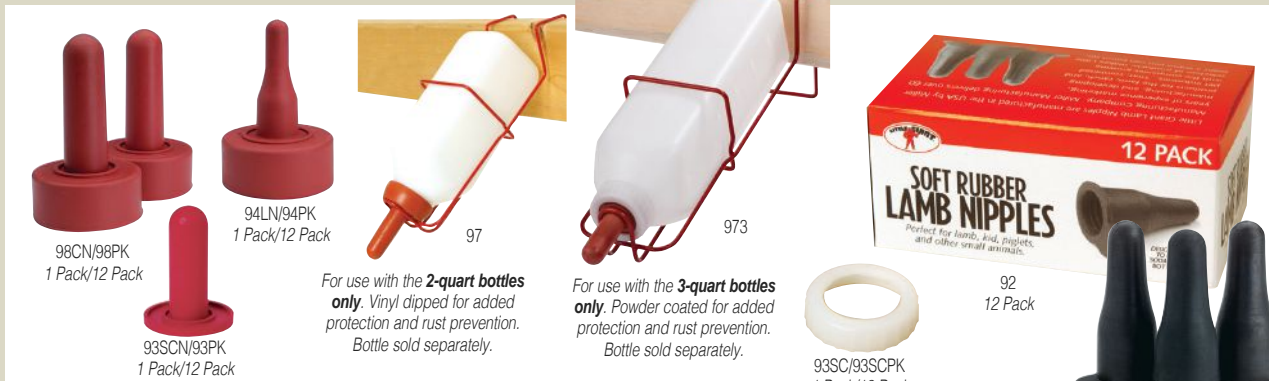

98CN/98PK 1 Pack/12 Pack

94LN/94PK 1 Pack/12 Pack

93SCN/93PK 1 Pack/12 Pack

For use with the 2-quart bottles only. Vinyl dipped for added protection and rust prevention. Bottle sold separately.

For use with the 3-quart bottles only. Powder coated for added protection and rust prevention. Bottle sold separately.

93SC/93SCP 1 Pack/12 Pack

92 12 Pack

92PK 3 Pack

Nipples and Nursing Accessories

Special rubber formula for long life and improved pliability. Calf nipples fit both 2 and 3 quart bottles.

98CN Snap-On Calf Nipple Bulk ✂
L 2.5" x W 2.5" x H 4" • 1 pk

98PK Snap-On Calf Nipple (2 per Bag) w/ UPC ✂
L 2.5" x W 7" x H 9" • 12 pk

93SCN Screw-On Calf Nipple Bulk ✂
L 2.25" x W 2.25" x H 3" • 1 pk

93PK Screw-On Nipple (1 per bag) w/ UPC ✂
L 6" x W 2.25" x H 8.25" • 12 pk

93SC Screw-On Cap Bulk ✂
L 2.5" x W 2.5" x H 0.625" • 1 pk

93SCP Screw-On Cap w/ UPC ✂
L 2.5" x W 2.5" x H 0.75" • 12 pk

94LN Snap-On Lamb Nipple Bulk ✂
L 2.5" x W 2.5" x H 3.5" • 1 pk

94PK Snap-On Lamb Nipple (1 per bag) w/ UPC ✂
L 2.5" x W 6" x H 8.5" • 12 pk

92 Soda Bottle Lamb Nipple (12 per Box) w/ UPC ✂
L 4.5" x W 2.75" x H 2" • 1 pk

92PK Soda Bottle Lamb Nipple (3 per Bag) w/ UPC ✂
L 3.75" x W 1" x H 7" • 12 pk

97 Calf Bottle Holder
L 13.5" x W 5" x H 6.5" • 6 pk
Mounts on any "2-by" board. For use on the 2-quart bottles only.

973 3 Quart Calf Bottle Holder
L 17.1" x W 7.3" x H 5.2" • 6 pk
Mounts on any "2-by" board. For use on the 3-quart bottles only.



DuraFork Stable Cleaners

Known as the best fork in the business. Often imitated, never duplicated. Manufactured from extra strong polycarbonate to provide strength and enhanced flexibility. Designed for long-lasting use around the farm and ranch. Specially designed tines are uniquely angled to provide easy scooping and with less spilling. Nylon locknut secures handle.

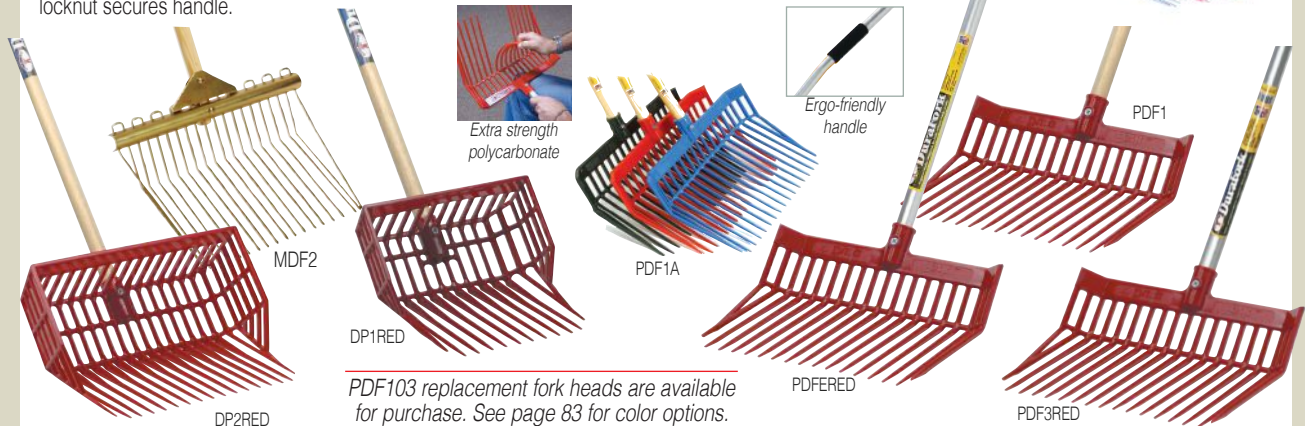

PDF103 replacement fork heads are available for purchase. See page 83 for color options.

MDF2 Metal DuraFork

L 8" x W 15" x H 60.5" • 3 pk
Made of 18-gauge yellow dichromate plated steel frame with support brace to prevent fork head from coming loose. 52" heavy-duty wood handle. Fork head is 11.325" long and 15" wide.

DP1RED DuraPitch 1

L 7.5" x W 11.5" x H 50.5" • 4 pk
Basket design makes easy scooping and less spilling. Smaller 42" handle makes it ideal for kids and small adults. Works great in confined spaces like horse trailers and small stalls. Fork head is 12.25" long and 11.5" wide. Available in: ■

DP2RED DuraPitch 2

L 8" x W 16" x H 61" • 3 pk
33% more carrying capacity than DuraPitch 1. Handle is 52" long. Fork head is 13" long and 16" wide. Available in: ■

DP2A DuraPitch 2 Assorted Pack

L 8" x W 16" x H 61" • 1 pk
3-color pack includes: ■ ■ ■

PDF1 DuraFork

L 8" x W 15.125" x H 61.5" • 3 pk
The original DuraFork with 52" handle. Fork head is 13.125" long and 15.125" wide. Available in: ■ ■ ■ ■ ■ ■ ■ ■ ■ ■ ■ ■

PDF1A DuraFork Assorted Pack

L 8" x W 15.125" x H 61.5" • 1 pk
3-color pack includes: ■ ■ ■

PDF3RED Aluminum Handle DuraFork

L 8" x W 15.125" x H 61.5" • 3 pk
52" lightweight anodized aluminum handle. Fork head is 13.125" long and 15.125" wide. Available in: ■

PDFERED Ergonomic DuraFork

L 8.5" x W 15.125" x H 61.5" • 3 pk
52" lightweight anodized pre-bent ergonomic handle and foam grip. Fork head is 13.125" long and 15.125" wide. Available in: ■

DuraFork Displays

These Fork Displays present Plastic DuraForks in your store simply and beautifully.

FORKDISP6 6 piece Fork Display

L 16.625" x W 17.625" x H 12" • 1 pk
Holds six DuraForks in any color, sold separately. Empty display ships flat in a 30.625" x 19.375" x 0.875" carton, ready for easy assembly in store. Set-up display measures 16.625" x 17.625" x 12". Forks sold separately.

FORKDISP12 12 piece Fork Display

L 36" x W 26.5" x H 30" • 1 pk
Holds twelve DuraForks in any color, sold separately. Features colorful graphics to draw attention to the forks and generate sales. Empty display ships flat in a 37.5" x 27.625" x 1.625" carton, ready for easy assembly in store. Forks sold separately.

PDF103DISP Fork Head Display with Fork Heads

L 16" x W 11.6" x H 13" • 1 pk
Holds four DuraFork replacement fork heads. This display includes two Hot Pink and two Lime Green heads. Great for adding popular Hot Colors to your in-store selection, in a smaller case pack. Comes fully assembled and ready to go.



Equine Care

Black powder-coated Sprayer Boom is designed for increased efficiency and to keep wash area neat and organized. Mounts on any wall or post, holding the hose up and away from feet. Gentle spray nozzle is animal friendly. Works great for equine and automotive wash stalls. Easy to install. 100 psi working pressure and 350 psi burst pressure.

169516 Sprayer Boom • 1 pk
Extends out to 8' and swivels 180 degrees.





DuraTote Stool

Combination tote box and step stool. The step stool fits over a DuraTote which features a moveable handle. An internal tray fits onto the tote for extra storage. Ideal for any horse owner but can also be used for gardening, cleaning and painting. Available in: ■ ■ ■



DTSS DuraTote Stool

L 20" x W 16.125" x H 14" • 2 pk

! A padlock can be attached to protect contents



Stores up to 12" tall 32-oz. spray bottles and cans



DTSS Patented Design



Multi-Purpose Muck Cart

Helps perform common chores around the farm. Durable construction can hold up to 350 lbs. It even folds for storage.

CA500 Muck Cart

L 31.5" x W 28.5" x H 35.5" • 1 pk



Retractable kickstand



Folds easily for storage.

PSB70 Muck Tub not included. See page 17 for details



CA500 Patented Retaining ring collapses for easy unloading

Professional Spray Bottles

All-purpose 32 oz. spray bottle can be used to apply insecticides, disinfectants and most veterinary products with ease. Sprayer works with no o-ring to wear out. Great for use around the house. Available in: ■ ■ ■ ■ ■ ■ ■

PS32 Professional Spray Bottles

L 4.375" x W 4.375" x H 10.5" • 12 pk



PS32

DuraTote Tote Boxes

Keep grooming supplies organized with the Little Giant® DuraTote. Extra-thick sidewalls and compartments make this tote the one that will last a long time! Compartments hold brushes, creams and sprays. Handle features holes to hold picks and tools. Ideal for storing household cleaning or automotive supplies. Available in: ■ ■ ■ ■ ■ ■ ■

DT6 Plastic DuraTote

L 18" x W 13.75" x H 10" • 6 pk



DT6



Modified handle for carrying tools (Brushes, bottles and tools not included)





Galvanized Feeders

167543 Galvanized Hanging Corner Feeder
L 6.875" x W 3.375" x H 6.187" • 6 pk

Works great for supplemental uses like feeding shells or grit. Space-saving corner design with built-in hooks for hanging in hutch or coop. Sturdy galvanized steel has rolled edges for safety.

167451 1 Pint Galvanized Round Hanging Waterer
L 5.75" x W 4.25" x H 5.75" • 6 pk

Built-in hooks allow this waterer to hang off the ground to reduce spillage and soiling of water. Gravity-feed design is easy to fill and clean. Sturdy galvanized steel has rolled edges for safety. Economical and perfect for the small flock of juvenile and adult birds.

167611 1 Gallon Galvanized Bucket Waterer
L 9.875" x W 7.5" x H 9.5" • 4 pk

Unique design serves as a bucket for filling and carrying, then converts to a gravity-feed waterer. Sturdy galvanized steel has rolled edges for safety. Perfect for small poultry flocks. Recommended for juvenile and adult birds.



167543



167611
1 Gallon



167451
1 Pint

Round Waterers

Perfect for chicks. Rounded, embossed edges help reduce chafing on head, neck and sheens.

9826 1 Quart Jar Waterer Base
L 5.5" x W 5.5" x H 1.125" • 12 pk

MJ9826 Mason Jar Baby Chick Waterer

L 5" x W 5" x H 7" • 6 pk
Gravity chick waterer comes fully assembled and features a glass mason jar. Easy to fill and clean, it holds 1 quart of water. The base is made of heavy-duty galvanized steel with rounded, embossed edges to help reduce chafing on chick's head, neck and sheens.



9826
1 Quart



9808



MJ9810



MJ9826

Round Feeders

Perfect for chicks. Rounded, embossed edges help reduce chafing on neck and head. Removable cover.

9808 6" Round Feeder
L 6" x W 6" x H 2" • 12 pk

9810 1 Quart Round Jar Feeder Base
L 6" x W 6" x H 2.5" • 12 pk

MJ9810 Mason Jar Chick Feeder
L 6.125" x W 6.125" x H 8.625" • 6 pk
Gravity chick feeder comes fully assembled and features a glass mason jar. Easy to fill and clean, it holds 1 quart of feed. The base is made of heavy-duty galvanized steel. Base includes eight feeding holes.



9826 & 9810 can be paired with a glass mason jar or #690 plastic 1-quart jar found on pg 39. Sold separately.

Painted Galvanized Bucket Waterer

These buckets let you easily carry water to your backyard flock, then use the bucket itself as a poultry waterer! Unique design serves as a bucket for filling and carrying, then converts to a gravity-fed waterer. Attractively painted, sturdy galvanized steel has rolled edges for safety. Small size with built-in handle is perfect for small poultry flocks. Recommended for juvenile or adult birds.

PGB1 1 Gallon Painted Galvanized Bucket Waterer
L 7.3" x W 7.3" x H 8.3" • 6 pk

PGB2 2 Gallon Painted Galvanized Bucket Waterer
L 8.7" x W 8.7" x H 9.6" • 6 pk



PGB1
1 Gallon



PGB2
2 Gallon



Galvanized Double Wall Founts

These Little Giant® waterers are constructed of heavy-gauge galvanized steel and are available in four sizes. Edges are rolled for safety and feature arched inner handles for added strength. Copper spring and neoprene seal produce a positive water shut-off. Seams are constructed and tested to prevent leaks. Double wall founts also feature a locking pin.

ITEM	DESCRIPTION	SIZE	CASE PACK
9832	2 Gallon Double Wall Fount	L 12.25" x W 12.25" x H 10.75"	4 pk
9833	3 Gallon Double Wall Fount	L 12.25" x W 12.25" x H 15"	2 pk
9835	5 Gallon Double Wall Fount	L 15.25" x W 15.25" x H 15.25"	2 pk
9838	8 Gallon Double Wall Fount	L 15.25" x W 15.25" x H 22"	2 pk



9832
2 Gallon



9833
3 Gallon



9835
5 Gallon



9838
8 Gallon

Locking pin holds cover securely in place.



Galvanized Hanging Feeders

Little Giant® hanging feeders are constructed of heavy-gauge galvanized steel with rolled edges for safety.

ITEM	DESCRIPTION	SIZE	CASE PACK
9112	12-lb. Feeder Tube w/ 12" Feeder Pan	L 12" x W 12" x H 10.125"	6 pk
914043	30-lb. Feeder Tube w/ 14" Feeder Pan	L 14.25" x W 14.25" x H 14.25"	6 pk
914273	40-lb. Feeder Tube w/ 17" Feeder Pan	L 17" x W 17" x H 20.25"	6 pk
9140	30-lb. Feeder Tube w/ Hanging Handle	L 10.75" x W 10.75" x H 13.875"	12 pk
9142	40-lb. Feeder Tube w/ Hanging Handle	L 11" x W 11" x H 19.25"	6 pk
9143	14" Feeder Pan w/ Attachment Hooks for Pan*	L 14.25" x W 14.25" x H 2.25"	12 pk
9173	17" Feeder Pan w/ Attachment Hooks for Pan*	L 17" x W 17" x H 2.75"	12 pk

*For use with 30 or 40-lb. feeder tube.



914043
Tube and
Pan Complete

9140
Tube only

9143
Pan only



9112
Tube and
Pan Complete



914273
Tube and
Pan Complete

9142
Tube only

9173
Pan only



9144

9144 Feeder Cover

L 11.5" x W 11.5" x H 2.25" • 1 pk
Prevents roosting, keeps feed dry and clean. For use with 12, 30, and 40 lb. feeder tubes. Feeder must be suspended for cover to function as designed.



171267

Galvanized Feeders

171267 Galvanized High Capacity Poultry Feeder

L 11" x W 12" x H 22.625" • 1 pk
 Made of heavy-gauge galvanized steel for durability. Feeder comes completely assembled for easy setup and immediate use. Ability to mount on wall or frame and stores and dispenses up to 25 lbs of mash, pellet or crumble feed. Specially designed chute provides steady food flow. Feed saver grid prevents bottom from overflowing and keeps birds from sweeping feed out of unit.



GTF22

GTF22 22 Lb Galvanized Treadle Feeder

L 11.8" x W 11.4" x H 16.3" • 1 pk
 Clever design enables birds to step on the panel to gain access to the feed. Door closes automatically after the birds are done feeding to keep critters out and prevent feed waste. Made of heavy-duty galvanized steel. Holds up to 22 lbs. of feed. Recommended for juvenile or adult birds.

Reel Top Ground Feeders

Curved feed-saving lip with snap-in reel. Made of heavy-gauge galvanized steel and features rolled edges for safety.

ITEM	DESCRIPTION	SIZE	CASE PACK
9818	18" Reel Top Ground Feeder	L 18.5" x W 4" x H 2.5"	12 pk
9824	24" Reel Top Ground Feeder	L 23.625" x W 4.25" x H 2.25"	12 pk

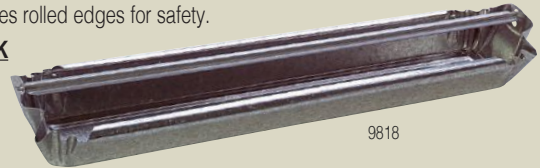

9818

Slide Top Ground Feeders

Individual holes minimize waste. Top slides off for easy access. Made of heavy-gauge galvanized steel and rolled edges.

ITEM	DESCRIPTION	SIZE	CASE PACK
9814	12" Slide Top Feeder	L 12.5" x W 3.875" x H 2.75"	12 pk
9822	18" Slide Top Feeder	L 18.5" x W 3.75" x H 2.5"	12 pk
9830	24" Slide Top Feeder	L 24.75" x W 4" x H 2.625"	12 pk



9822

Range Ground Feeders

Off-the-ground design for larger birds. Heavy-gauge galvanized steel and features rolled edges.

ITEM	DESCRIPTION	SIZE	CASE PACK
9836	36" Range Feeder	L 36.25" x W 6.5" x H 6.75"	6 pk
9848	48" Range Feeder	L 48.25" x W 6.5" x H 6.75"	6 pk



9836

TR20GALV Galvanized Trough Feeder with Narrow Grid

L 20" x W 5" x H 3.9" • 6 pk

Made of sturdy galvanized steel, this ground feeder features slanted feed-saver bars that prevent roosting. Legs help boost the feeder off the ground. Great for juvenile or adult birds.

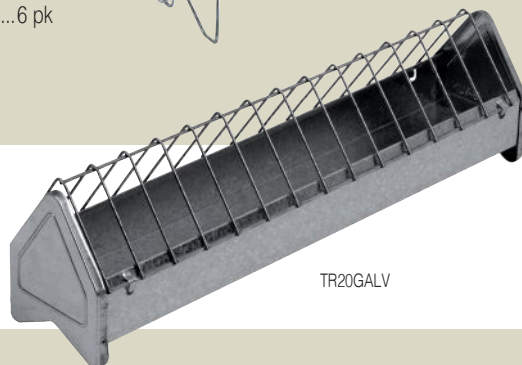

TR20GALV



Plastic Ground Feeder

Snap-in hinge ensures long-lasting use.

820 20" Plastic Flip Top Feeder ✪

L 20" x W 4.5" x H 3" • 12 pk

Available in: ■ ■ ■ ■

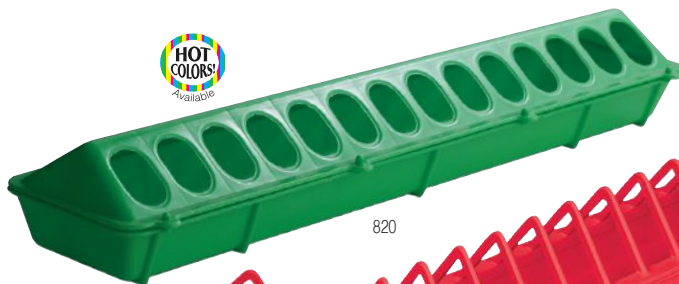

820

TR20PLW Plastic Poultry Trough Feeder with Wide Grid

L 20" x W 4.7" x H 4.9" • 12 pk

Made of durable plastic, this ground feeder features slanted feed-saver bars that prevent roosting. Legs help boost the feeder a bit off the ground. Feed saver grid is widely spaced to accommodate larger birds. Recommended for juvenile or adult birds.

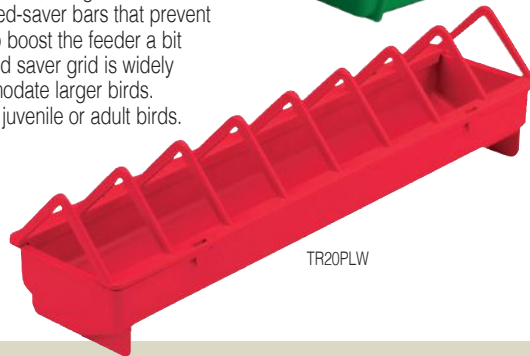

TR20PLW

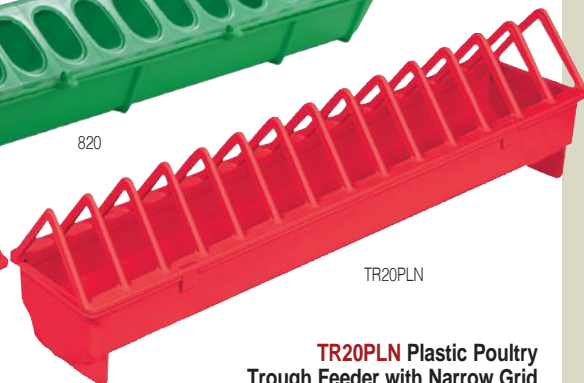

TR20PLN

TR20PLN Plastic Poultry Trough Feeder with Narrow Grid

L 20" x W 4.7" x H 4.9" • 12 pk

Made of durable plastic, this ground feeder features slanted feed-saver bars that prevent roosting. Legs help boost the feeder off the ground. Great for juvenile or adult birds.



CUP2



Plastic Poultry Cups

CUP2 Poultry Drinking Cups, 2 Pack

L 7.25" x W 5.25" x H 2.125" • 6 pk

Use these handy cups to create your own low-maintenance poultry waterer! Threaded, screw-in attachment fits into a 3/8" hole drilled into a PVC pipe or any plastic container. Made of durable plastic and features a small bar that birds peck to activate the flow of water. Can be installed either horizontally or vertically. 2 per package.



Plastic & Galvanized Cage Cups are also available see page 79.

Deep Base Poultry Waterers

These Deep Base Waterers are best for juvenile and adult birds. The handy design allows the base to remain on the jug while filling from bottom. Includes rubber stopper with o-ring on bottom to prevent leaks. Comes with carrying handle.

ITEM	DESCRIPTION	SIZE	CASE PACK
DBW11 Gallon Deep Base Poultry Waterer.....	L 8.375" x W 11.875" x H 11.875"5 pk
DBW22 Gallon Deep Base Poultry Waterer.....	L 13.25" x W 11.875" x H 11.875"5 pk
DBW33 Gallon Deep Base Poultry Waterer.....	L 18.125" x W 11.875" x H 11.875"5 pk

Fits securely in base of Deep Feeders/Waterers

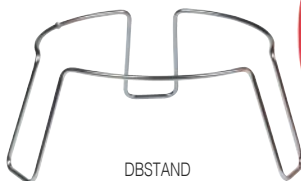

DBSTAND

DBSTAND Metal Stand for Deep Base Waterers

L 4.5" x W 10" x H 10" • 5 pk

This stand works with our Little Giant® Deep Base Waterers to raise the waterer off the ground to keep dirt and debris out of the water.



DBW2
2 Gallons/8 Liters



DBW1
1 Gallon/5 Liters



DBW3
3 Gallons/11 Liters



Plastic Poultry Feeders

Feed saver lips minimize spillage. The 11-lb. and 22-lb. feeders feature adjustable feed levels. Anti-scratch vanes help prevent crowding and feed waste. Product designed to be used on ground or suspended.

ITEM	DESCRIPTION	SIZE	CASE PACK
PHF3	3 Lb Poultry Feeder	L 8.25" x W 8.25" x H 8.75"	12 pk
PHF11	11 Lb Poultry Feeder	L 12" x W 12" x H 11.5"	6 pk
PHF22	22 Lb Poultry Feeder	L 16.75" x W 16.75" x H 16"	2 pk
PC11	Poultry Feeder Cover for 11-lb. Feeder	L 7.325" x W 7.325" x H 3.5"	1 pk
PC22	Poultry Feeder Cover for 22-lb. Feeder	L 10" x W 10" x H 5"	1 pk



PHF22 with optional PC22 cover



PHF3
3 Lb



PHF11
11 Lb



PHF22
22 Lb

Large Capacity Automatic Waterers

Top fill design. The vacuum-sealing cap creates an automatic water flow. Jar snaps onto base.

ITEM	DESCRIPTION	SIZE	CASE PACK
PPF3	3 Gallon Poultry Fount	L 16" x W 16" x H 14.75"	2 pk
PPF5	5 Gallon Poultry Fount	L 16" x W 16" x H 19"	2 pk
PPF7	7 Gallon Poultry Fount	L 16" x W 16" x H 24"	1 pk



*Improved cap design.
O-ring fits securely in a
machined radial groove.*



PPF3
3 Gallon



PPF5
5 Gallon



PPF7
7 Gallon

Patented Design

PPF310KIT

Replacement kit available.
Contains 3 O-rings and 1 small
black cap. See page 84.

Poultry Waterer

Built-in handle for easy portability.

7906 3 Gallon Poultry Waterer

L 12" x W 12" x H 16" • 6 pk

PLB15 1.5 Gallon

Plastic Bucket Poultry Waterer

L 8.7" x W 8.7" x H 9.6" • 5 pk

Same unique design as our galvanized bucket waterers, but made of durable plastic. Serves as a bucket for filling and carrying, then converts to a gravity-fed waterer. Lid is removable for easy filling and cleaning. 1.5-gallon size with built-in handle is perfect for small poultry flocks. Recommended for juvenile or adult birds.



7906

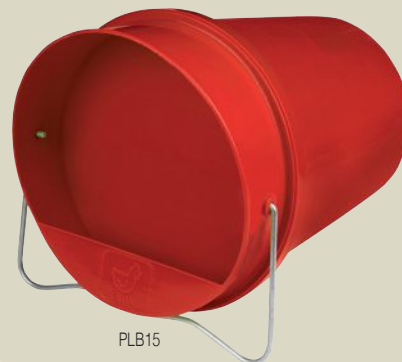

PLB15



*Lid removes for
easy cleaning*



Plastic Dome Feeders

Large-capacity feeder for your flock. Made out of durable plastic with UV protection. Easy to fill, thanks to the top-fill design and lid. Fill from the top and screw the lid on tightly to protect feed from the elements. Three legs are easily assembled to the base and keep the feeder off the ground. Feed Saver Ring minimizes spillage to prevent wasted food and is easily removed for cleaning. For most poultry or waterfowl.

ITEM	DESCRIPTION	SIZE	CASE PACK
DOMEFDR3535 lb. Plastic Dome Feeder.....	L 22.75" x W 18.25" x H 18.25" 1 pk
DOMEFDR4545 lb. Plastic Dome Feeder.....	L 26.5" x W 18.25" x H 18.25" 1 pk
DOMEFDR6060 lb. Plastic Dome Feeder.....	L 30.75" x W 18.25" x H 18.25" 1 pk



Plastic Dome Waterers

Best suited for juvenile and adult birds. Large-capacity waterer for your flock. Made out of durable plastic with UV protection. Top-fill design is easy to use. Valve in base controls water flow – close when filling, then open to allow water to fill the base. For best results, set waterer on flat ground before filling. Accommodates up to 40 chickens, also works well for most poultry and some waterfowl.

ITEM	DESCRIPTION	SIZE	CASE PACK
DOMEWTR55 Gallon Plastic Dome Waterer.....	L 17.5" x W 18.25" x H 18.25" 1 pk
DOMEWTR88 Gallon Plastic Dome Waterer.....	L 24.25" x W 18.25" x H 18.25" 1 pk
DOMEWTR1010 Gallon Plastic Dome Waterer.....	L 28.5" x W 18.25" x H 18.25" 1 pk





Plastic Waterer Jars & Bases

Jars are molded from durable, translucent polyethylene so the water level is always visible. Choose from threaded or lug design. Light weight, colorful designs, and very simple to use.

666 1 Gallon Threaded Jar
 L 7" x W 7" x H 9.25" • 12 pk

750 1 Gallon Screw-On Base fits #666
 L 9" x W 9" x H 1.5" • 12 pk
 Available in:

7506 1 Gallon Poultry Fount Complete
 L 9" x W 9" x H 10.25" • 6 pk
 Includes 666 and 750. Now with one UPC for easier scanning at the register.
 Available in:

680 1 Gallon Nesting Jar with Lug Design
 L 8" x W 8" x H 7.5" • 12 pk
 The 680 nesting jar reduces storage space and shipping costs.

780 1 Gallon Nesting Base fits #680
 L 11" x W 11" x H 1.75" • 12 pk
 Lug design. Available in:

690 1 Quart Screw-On Jar
 L 3.5" x W 3.5" x H 7.25" • 36 pk

730 1 Quart Threaded Quail Base fits #690
 L 4" x W 4" x H 1.25" • 24 pk
 Base features a narrow channel designed specifically for smaller birds.

740 1 Quart Threaded Base fits #690
 L 6" x W 6" x H 1.5" • 36 pk
 Available in:

806 1 Quart Plastic Feeder Base
 L 6.375" x W 6.325" x H 2.5" • 12 pk
 Constructed out of durable polypropylene. Base features 8 openings with ribs to minimize feed spillage. Removable cover. Available in:



Chick Starter Kit

CKDISP Chick Starter Kit
 L 20.38" x W 13.38" x H 54.63" • 1 pk
 Ships fully loaded and ready to display.

Includes the following items:

- 12 pcs. 740
- 12 pcs. 740LIMEGREEN
- 6 pcs. 740PURPLE
- 6 pcs. 740YELLOW
- 12 pcs. 806RED
- 12 pcs. 806APPLEGREEN
- 6 pcs. 806PURPLE
- 6 pcs. 806YELLOW
- 30 pcs. 690



CKDISP

Poultry Kit

PLTRYDISP Poultry Kit
 L 20.75" x W 23.75" x H 54" • 1 pk
 Ships fully loaded and ready to display. Compact footprint fits just about anywhere.

Includes the following items:

- 24 pcs. 680
- 6 pcs. 780
- 6 pcs. 780PURPLE
- 6 pcs. 780LIMEGREEN
- 6 pcs. 780YELLOW
- 12 pcs. 820
- 12 pcs. 820PURPLE
- 12 pcs. 820LIMEGREEN
- 12 pcs. 820YELLOW



PLTRYDISP



Hen Hydrator

These gravity-fed waterers provide access to clean water on demand. The translucent bucket was designed to provide UV protection to help prevent algae growth and allow for easy viewing of the water level. Lid fits tightly to prevent spills and protects contents while easy-to-remove fill plug allows for refilling without having to remove the entire lid. Each nipple can accommodate up to 4 juvenile or adult birds. Hanging height will vary by breed but should be high enough so that chickens must reach up slightly to drink. These waterers are recommended for juvenile or adult birds only and is not recommend for use in freezing weather. For best results remove all other water sources, and tap each nipple so chickens can see water dripping. Acceptance of this watering method may take time but once a few birds begin to use it, others should follow.

HH1 1 Gallon Hen Hydrator

L 7.5" x W 7.5" x H 7.375" • 3 pk

HH35 3.5 Gallon Hen Hydrator

L 12.875" x W 12.375" x H 18.25" • 4 pk

172035 4 Pack Nipples for Hen Hydrator

L 31.5" x W 4.5" x H 1.25" • 12 pk

Transform a standard bucket or PVC pipe into a poultry watering device. Nipples are easy to install and help keep water clean and prevent disease. Each nipple accommodates up to 4 juvenile or adult birds. Nipples should be mounted vertically.



Improved handle for easy hanging!

Replacement nipples available. Part # 172035. See page 86.

172035



166386

Automatic Poultry Waterer

Includes a 30" hose (3/4" diameter) that attaches to a standard garden hose for a continuous flow of fresh water for your flock. Automatic float controls the water level so there is no spilling or overflow. Oversized cover extends beyond the edge of the bowl to keep debris out of the water. Angled cover prevents roosting. Designed for use with juvenile or adult birds (not intended for chicks).

166386 Automatic Poultry Waterer

L 14" x W 12.75" x H 10.5" • 1 pk

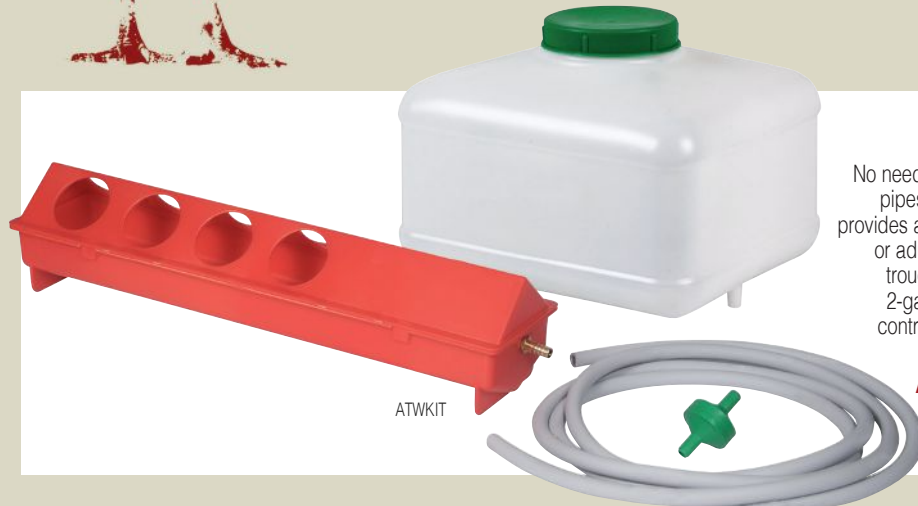

ATWKIT

Automatic Waterer Kit

No need to worry about water pressure or freezing pipes with this waterer! This gravity-fed waterer provides a continuous flow of fresh water for juvenile or adult poultry. Kit includes 20" plastic drinking trough with float valve, 6 feet of flexible tubing, 2-gallon water tank and a filter. Automatic float controls the water level so there is no spilling or overflow. Easy to assemble and clean.

ATWKIT Automatic Trough Waterer Kit

L 20.4" x W 13.1" x H 9.4" • 1 pk



Automatic Poultry & Game Bird Founts

Miller's original product dating back to our roots in 1941. The Little Giant® poultry founts have been used by poultry experts for years. These dependable waterers hook up to any standard 1/2" NPT pipe to provide a limitless supply of clean water. Safely operates between 20-50 psi.

2500 Game Bird Fount

L 6.5" x W 6.5" x H 5" • 6 pk

Holds 2 pints of water and waters up to 175 birds. Bowl measures 6.5" in diameter and 2.5" deep.

2525 Baby Chick Fount

L 7.25" x W 7.25" x H 5" • 6 pk

This extra shallow bowl helps reduce the risk of baby birds drowning. Holds 1.5 pints of water and waters up to 200 chicks. Bowl measures 7.25" in diameter and 1.25" deep.

2550 King Size Fount

L 8.5" x W 8.5" x H 5" • 6 pk

Holds up to 1.5 quarts and waters up to 250 adult birds. Bowl measures 8.5" in diameter and 2.75" deep. Works well for larger birds, like turkey or peafowl.

1018 Bowl Guard

L 6.75" x W 6.75" x H 1.75" • 1 pk

Accessory for the King Size (2550) and Game Bird (2500) Founts. Acts as an anti-roost device. Helps prevent debris from getting into water.



Egg Carton

High-quality, natural colored (gray) 100% reclaimed paper features simple, classic farm imagery. Includes the required FDA Safe Handling Instructions and Keep Refrigerated Warnings. No grade or size specified on carton, so carton can be used for a variety of egg sizes. Solid top. Comes in a pack of 200 cartons.

EGGCTNSLD Egg Carton

L 11.75" x W 4" x H 3.75" • 200 pk



Egg Flats

These 5x6 Egg Flats hold up to 30 eggs, size small up to extra large. Great for selling or transporting your eggs, or for storing and organizing small parts.

EGGFLAT30 Egg Flat (12 per package)

L 11.75" x W 11.75" x H 1.75" • 4 pk

Egg Baskets

Basket design allows for easy cooling, washing and quick drying of eggs. It is made of heavy-duty coated wire to help prevent corrosion and is securely welded at every joint.

EB8 Egg Basket Small

L 8.5" x W 8" x H 5.625" • 6 pk

Holds up to 3 dozen large eggs.

EB13 Egg Basket Large

L 13.375" x W 13" x H 6.875" • 6 pk

Holds up to 8 dozen large eggs.



Ceramic Eggs

Simply place these ceramic eggs in a nesting box to encourage hens to lay eggs. They look and feel like the real thing – same color, size and weight! They also help discourage chickens from pecking or eating eggs.

CEGGBRN Ceramic Nest Eggs

Brown (2 per pack)

CEGGWHT Ceramic Nest Eggs

White (2 per pack)

L 4.25" x W 1.75" x H 7.25" • 6 pk





BROODER

Works great with other Little Giant® accessories. Sold separately.

Brooder

BROODER Galvanized Chick Brooder Box

L 39.4" x W 18.7" x H 23.6" • 1 pk

A safe observatory for brooding baby chicks up to four or five weeks old. Sturdy metal arm holds a brooder lamp (sold separately) over one side of the brooder. Chicks can move between the section of the brooder with solid metal walls and the section with wire grid walls to warm up or cool down as needed. Wire mesh floor has openings 5/16" apart. Pine shavings, hay, or straw can be used for bedding, especially if the breed you have selected have smaller sheens for the floor spacing. Dropping pan slides in and out under the wire mesh floor for easy removal and cleaning. Easily assembled using a flathead screwdriver and the included hardware.



Quick & Easy Set-Up!

Circular design prevents corner crowding which can result in chick injury and/or suffocation

172196

Brooder Kit

Kit comes with a washable and reusable plastic corrugated wall and stand which includes a hook for a Brooder Reflector Lamp to be hung.

The lamp stand can be secured to the wall for added safety with the included cable ties. This stand is also adjustable allowing the height of the lamp to be modified as chicks grow. Enclosure measures approximately 3 feet in diameter and 16" (40.6 cm) tall when assembled and is suitable for up to 15 chicks, depending on breed.

172196 Chick Brooder Kit

L 32.5" x W 34" x H 34" • 1 pk

Brooder Lamp

Heat-resistant ceramic socket and double wire bulb guard for safety. Features 6-foot electrical cord specially designed to prevent wires from coming loose and causing shock. The cord also features polarized male prongs and scratch-resistant clamp with ball joint for easy positioning. Corrosion-resistant aluminum shade has a built-in hanger. Uses 300W bulb maximum. cULus Listed.

170017 10.5" Brooder Reflector Lamp

L 10.5" x W 5.875" x H 13" • 4 pk



170017



Easy to display packaging!



Easy to display packaging!



170024 Red Bulb

170031 Clear Bulb

Brooder Lamp Bulbs

Designed to provide enough heat for small flocks. 250 watt/120 volt bulb is great for brooding chickens and other poultry. Alloy bulb with non-stick base and 6,000-hour bulb life. Extra thick filaments are enclosed in a high quality bulb made with test tube glass. Additional filament support wires increase the durability and life of the bulb.

170024 Red Heat Lamp Bulb

L 5" x W 5" x H 6.5" • 12 pk

Red bulb helps disguise blood to protect injured chicks from further pecking.

170031 Clear Heat Lamp Bulb

L 5" x W 5" x H 6.5" • 12 pk

Beginner Poultry Kit

This handy kit contains everything you need to get your chicks started! Includes a 250W red heat lamp bulb and 10.5" reflector lamp to provide safe heat, plus an 8" ground feeder, a 1.5-lb. plastic feeder and a 1.5-qt. plastic chick waterer. You'll also get our Guide to Backyard Poultry, which includes helpful tips, information and fun facts for your new flock. Bulb is 250 Watts/120 Volts, with a 6,000-hour life. The feeder holds up to 1.5 lbs. of feed. Waterer has a 1.5-qt. capacity. 8" ground feeder has 12 feeding holes (6 per side) and a covered top to keep out debris.

DTBPKIT Beginner Poultry Kit

L 15" x W 10.25" x H 9.375" • 1 pk



DTBPKIT

Double-Tuf

Easy to display packaging!



Nesting Boxes

163620 Single Nesting Box ✪

L 16.5" x W 15.88" x H 19.75" • 6 pk

Made of high-density, impact-resistant polyethylene that is easy to keep clean and will not rust, rot or corrode. Mounts securely on wall with slide-type screw holes. Sloped roof prevents roosting.

- Mounts to 16" on-center studs
- Ventilation holes for fresh air
- Perch gives hens a place to land before entering nest

Hang three units vertically and fit within recommended guidelines - first unit should be mounted 24" off the ground to protect from predators. Top unit will be low enough from ceiling to prevent roosting.

Compare to metal and wood units:

- ✓ Stays warmer in winter months
- ✓ Easier to clean
- ✓ More sanitary
- ✓ Reduces mite and bug infestations



163620
Can mount vertically or side by side.



Staggered wall-mount tabs so two nests can share the same wall stud

165525 Open Nesting Box ✪

L 17" x W 11.625" x H 11.875" • 6 pk

Better than metal and wood nests, and costs less! Made of high-density, impact-resistant polyethylene that will not rust, rot, or corrode. Hen-friendly design features an open back and top to allow better ventilation and easier access to eggs in some coops. The front edge helps prevent loss of bedding and the slightly graded floor leads to a back drainage hole. Mounts securely on wall with slide-type screw holes or sits squarely on a shelf.

Space-saving modular layout can be mounted vertically or side by side on 16" on-center studs.



165525
Patented Design



GNB3



GNB1



GNB2



Ventilated bottom

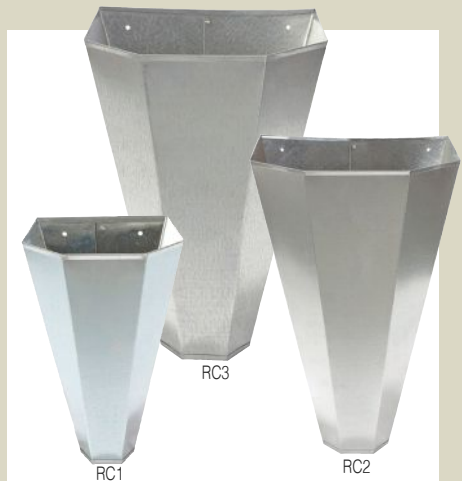

Restraining Cones

Cones restrain birds during processing and make clean up easy. Made of heavy-gauge galvanized steel with hemmed edges for safety. The flat back design allows for easy mounting.

RC1 Restraining Cone Small ✪

L 7.875" x W 5.875" x H 12" • 6 pk

For use on game birds, bantams, and small layers.

RC2 Restraining Cone Medium ✪

L 10.5" x W 7.25" x H 16" • 6 pk

For use on large layers, broilers, roasters and young turkeys up to 10 lbs.

RC3 Restraining Cone Large ✪

L 13.25" x W 9.25" x H 20.625" • 6 pk

For use on larger broilers and medium turkeys up to 18 lbs.

Galvanized & Plastic Nesting Boxes

Sides are made of galvanized steel for sturdiness while the top and roosting area are durable plastic that will not rust, rot or corrode. Amply sized, hen-friendly design features a front guard that prevents birds from scratching bedding out of the nest. Plastic bottom is ventilated and angled slightly so eggs won't roll out of the nest. Ships unassembled to save space and shipping costs.

ITEM	DESCRIPTION	SIZE	CASE PACK
GNB1	Single Galvanized and Plastic Nesting Box	L 10.5" x W 20.5" x H 17"	1 pk
GNB2	Double Galvanized and Plastic Nesting Box	L 21" x W 20.5" x H 17"	1 pk
GNB3	Triple Galvanized and Plastic Nesting Box	L 31.25" x W 20.5" x H 17"	1 pk



Digital Incubators

Durable styrofoam retains the warmth generated by a gentle and safe heating element controlled by a highly dependable, digital control board. The LCD display with LED light shows accurate temperature and humidity readings instantly. The self-regulating control board adjusts the temperature to suit varying environments. The built-in digital hygrometer and moisture channels help maintain humidity, a key factor in egg health during hatch.



Digital readout of temperature and humidity levels

6300 Automatic Egg Turner. See page 45.



Circulated Air Fan

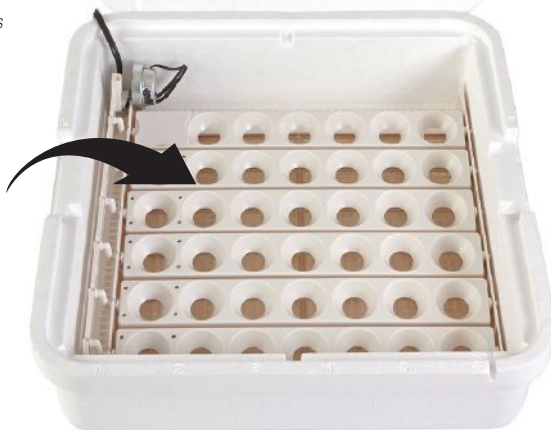

Performance and electronics of high-end, expensive incubators at hobbyist price points

- 41-egg capacity when used with Little Giant® 6300 Egg Turner
- Endorsed by game bird hobbyists
- Digital control board for easy, one-touch temperature setting
- Holds set temperature within ONE degree!
- State-of-the-Art Safety Features
 - Redesigned plastic heater is cooler to the touch than traditional metal heating elements that can reach a burning 265 degrees
 - Simple plug-and-play fan design featured on the 10300 and 11300 is easy and safe to set up, requiring no electrical knowledge
 - Mesh plastic screen has no sharp edges for both human and chick safety
- Built-in digital hygrometer measures humidity
- Predictive temperature control maintains accurate and consistent temperatures
- Accessible water channels reduce humidity loss to improve hatch rates
- Patented design



Compare to competitive units:

- ✓ Plastic vs. metal heating element
- ✓ Includes digital hygrometer
- ✓ Made in the USA
- ✓ Dishwasher-safe plastic screen - easy to clean



*Eggs not included with any product
 Little Giant® Incubators are not intended for professional or commercial use or for the incubation of exotic birds.



Digital Incubators (Continued)



Patented Design

9300 Digital Still Air Incubator
 L 18" x W 18" x H 9" • 1 pk

10300 Digital Circulated Air Incubator
 L 18" x W 18" x H 9" • 1 pk
 The 9300 with installed Circulated Air Fan Kit.



11300 Deluxe Incubator With Egg Turner
 L 18" x W 18" x H 9" • 1 pk
 The 10300 with installed Egg Turner included.

12300 CSA Listed Digital Incubator
 L 18" x W 18" x H 6" • 1 pk
 CSA Listed. Safe for use in schools.



6300 Automatic Egg Turner



6302 Quail Rails

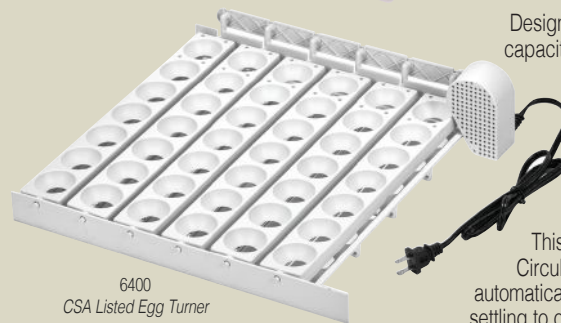

6400 CSA Listed Egg Turner

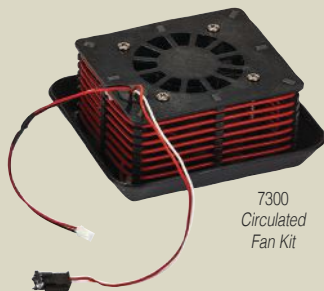

7300 Circulated Fan Kit



CANDLER

CANDLER Egg Candler
 L 3.6" x W 1.25" x H 7.5" • 6 pk
 Quickly and easily check the development of eggs. This battery-operated light features a bright, energy-efficient LED bulb that runs cooler than traditional bulbs. The convenient cord-free design fits easily in a pocket and features a wrist strap. Uses one AAA battery (included).



6303 Thermometer with Mylar backing to keep it on top of the eggs

Incubator Accessories

6300 Automatic Egg Turner
 L 15.25" x W 15" x H 3" • 1 pk

No assembly required. Easy to clean and operate. Turner is sold complete with 41 large egg cups (7 cups per rail). 6301 replacement large egg rails are available in a set of six and is sold separately.

6302 Quail Rails
 L 15" x W 2" x H 4" • 1 pk

Designed for quail and other small eggs. 120 egg capacity. Rails fit into 6300 and 6400 Egg Turners.

6303 Thermometer Kit
 L 4.25" x W 0.22" x H 4.5" • 1 pk
 Thermometer is filled with alcohol and kerosene, no mercury.

6400 CSA Listed Egg Turner
 L 15.25" x W 15" x H 3" • 1 pk

This CSA-listed Egg Turner fits any Little Giant® Circulated-Air or Still-Air Incubator. Electric motor automatically rotates the eggs to prevent the yolk from settling to one side and to exercise the embryo. Plastic cups hold 41 chicken eggs. (Turkey and duck eggs will not fit in this turner.) No assembly required. Dishwasher safe, easy to clean and operate. Quail rails for smaller eggs are sold separately.

7300 Circulated Air Fan Kit
 L 5.25" x W 4.875" x H 3.125" • 1 pk

Transforms the Little Giant® Still Air Incubator into a Circulated-Air Incubator. Recommended for environments with frequent temperature fluctuations. Fan constantly circulates the air to maintain a proper temperature throughout the incubator, eliminating harmful hot and cold spots.



Single Door Live Traps

LT1 Single Door Live Trap

L 18" x W 6.75" x H 6.5" • 1 pk
Ideal for mice, rats, weasels, red and flying squirrels, chipmunks and other similar sized animals.

LT2 Single Door Live Trap

L 24" x W 7.75" x H 7.5" • 1 pk
Ideal for squirrels, chipmunks, rabbits, muskrats, mink and other similar sized animals.



NEW Packaging!



LT1



LT2

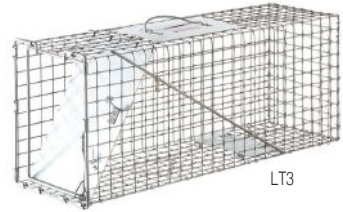

LT3

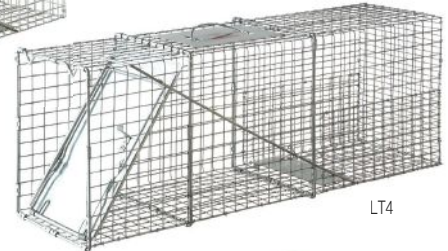

LT4



LT5

Double-Tuf

Two Traps in One!

Live Trap Combo Pack
Features 2 live traps in one pack! See page 97 for details.

Double Door Live Traps

Two open entryways allow animals to enter with more confidence.

DDL1 Double Door Live Trap

L 18.75" x W 7" x H 6.5" • 1 pk
Ideal for rats, weasels, red and flying squirrels, chipmunks and other similar sized animals.

DDL2 Double Door Live Trap

L 24" x W 7" x H 7" • 1 pk
Ideal for squirrels, chipmunks, rabbits, muskrats, mink and other similar sized animals.

DDL4 Double Door Live Trap

L 36.5" x W 10.25" x H 12.75" • 1 pk
Ideal for raccoons, woodchucks, skunks, opossums and other similar sized animals



DDL1



DDL2

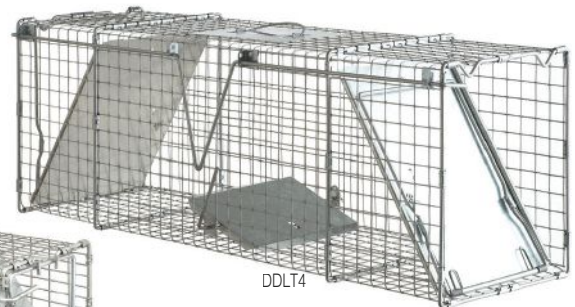

DDL4





SC1



Easy to display packaging!



PMT



PRT



Mouse & Rodent Traps

Finally, there's an easier way to capture mice and rodents. The Better Mouse Trap and The Better Rodent Trap have no complicated mechanical parts. Just press to set and squeeze to release. No-touch design makes these traps a snap to use. For mice, moles, shrews and other very small animals.

PRT The Better Rodent Trap L 7.5" x W 4" x H 3.5" • 6 pk

PMT The Better Mouse Trap L 3.5" x W 2" x H 1.812" • 6 pk
2 per card

SC1 Sure Catch Multiple Catch Mouse Trap L 10.25" x W 2" x H 6.5" • 6 pk

Fill-Fast Funnels

Little Giant® Fill-Fast Funnels are made of corrosion-proof polyethylene resin that can be used with practically any chemical and never rust. Initially designed for use in cold climates, these funnels hold up under tough environmental conditions.

100045 1 Pint Funnel with Screen
L 5" x W 4.75" x H 6" • 6 pk

The Fill-Fast Junior is a great seller in both urban and rural stores. Comes with a fine mesh brass screen.

100038 2 Quart Funnel with Screen
L 7.5" x W 7" x H 8.5" • 6 pk

The Fill-Fast All Purpose heavy-duty funnel sells itself...everywhere! Comes with a fine mesh brass screen.

100021 6 Quart Funnel with Screen
L 10.125" x W 9.125" x H 10.5" • 6 pk

The Fill-Fast Giant is designed to withstand rugged farm and industrial use. Comes with a fine mesh brass screen.

100069 1 Pint Funnel with Extension and Screen
L 5" x W 4.75" x H 19.25" • 6 pk

The Fill-Fast Fills-All is designed for automatic transmissions, but ideal for many hard to reach applications. Coarse brass screen allows flow of petroleum lubricants.



100045
1 Pint

Our brass screens are heat sealed in to provide a long, dependable life

100038
2 Quart

100021
6 Quart

100069
1 Pint



Oil Pans

P3 3 Gallon Plastic Utility Pan
L 17.25" x W 17.25" x H 4.5" • 12 pk
Available in:

91BLACK 7 Quart Oil Pan
L 14.25" x W 14.25" x H 4" • 36 pk
Features pouring spout & hanging tab.
Available in:

GP13 13 Quart Galvanized Oil Pan
L 16.25" x W 16.25" x H 3.75" • 12 pk



P3
3 Gallon



91BLACK
7 Quart



GP13
13 Quart



PT20BLACK
20 Gallon

PT20BLACK 20 Gallon Utility Tub
L 35.5" x W 24" x H 7.25" • 1 pk

This tough, impact-resistant rectangular tub is ideal for washing automotive parts, mixing concrete, or any application requiring a large, low-profile container. High-density polyethylene protects against warpage, stress cracks, and UV damage. Features a rounded lip for added durability.



Pre-Cut Rubber Utility Mats

Little Giant® has all your flooring needs covered! Great for work or farm use. We carry a full line of Pre-Cut Rubber Utility Mats, Rolled Rubber Mats and VersaPad™ options.



RMRACK

Free display with purchase of 5 pre-cut utility mats.

RMRACK 5 Slot Mat Rack
39" x 22.75" x 80" • 65 lbs. • 1 pk
These space-saving racks feature colorful graphics to draw attention to the product and generate sales.

Mat Specifications (for all Pre-cut Utility Mats)	
Weight	7.32 kg/m ²
Hardness.....	65 Shore A Nominal
Density	1350 kg/m ³
Elongation	> = 180%
Shearing Strength.....	< 0.60 (N/mm ³)
Temperature Stability.....	30 70
Compression Recovery	After 22 hours 75%
Tensile Strength	400 PSI
Critical Radiant Flux.....	0.11 watts/sq
Thermal Resistance	150 ppi



- RM3660 Pre-Cut Utility Mat**
60" x 36" x 0.25" • 22 lbs. • 1 pk
- RM4096 Pre-Cut Utility Mat**
96" x 40" x 0.25" • 43.78 lbs. • 1 pk
- RM4872 Pre-Cut Utility Mat**
72" x 48" x 0.25" • 38.6 lbs. • 1 pk
- RM4896 Pre-Cut Utility Mat**
96" x 48" x 0.25" • 50.5 lbs. • 1 pk
- RM6096 Pre-Cut Utility Mat**
96" x 60" x 0.25" • 65 lbs. • 1 pk
- RM60120 Pre-Cut Utility Mat**
120" x 60" x 0.25" • 71 lbs. • 1 pk

Applications

- Exercise areas
- Kennels
- Barns
- Horse stalls
- Trailers
- Garages
- ATV/truck beds
- Work benches
- Camping

Features

- Textured top for traction
- Grooved bottom for drainage
- Tailored sizes – minimal cutting
- Non-porous surface - will not harbor bacteria
- Made from recycled rubber and SBR

Benefits

- Will not shrink, curl or crumble
- Easy to clean
- Easy lifting and moving



RMIL3636 Trak-Safe Interlocking Mat
36" x 36" x 0.59" • 15.85 lbs. • 1 pk

Applications

- Work areas
- Door entrances
- Wash down areas for bikes, ATV's, etc.

Features

- Interlocking edges
- Large open design
- Soft, yet durable
- Raised nubs on underside
- Made from recycled rubber and natural rubber

Benefits

- Can cover large areas without movement
- Exceptional drainage characteristics
- Allows water and debris to fall through
- Provides cushion under foot

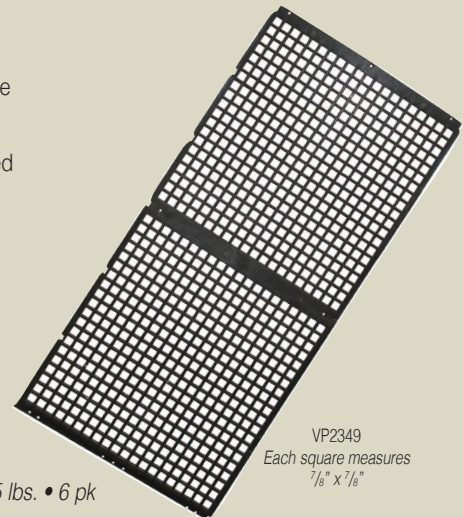

VP2349
Each square measures 7/8" x 7/8"

VP2349 VersaPad™ 
24" x 48.625" x 0.5" • 8.05 lbs. • 6 pk

Applications

- Kennel flooring
- Greenhouse benching
- Paver installation
- Turf landscaping
- Slope protection

Features

- Interlocking edges
- Non-porous surface - will not harbor bacteria
- Moisture and waste dry fast
- Made from polypropylene

Benefits

- Surface allows for proper drainage and airflow for plants and animals
- Provides a great foundation under pavers while allowing for drainage
- Protects turf and soil from pedestrian foot traffic
- Holds 10-lbs. for every square foot



Rolled Rubber Mats



RMWR349 Wide Rib
49' x 3.25' x 0.15" • 164 lbs. • 1 pk

Applications

- High traffic areas
- Door and walkways

Features

- Long lengths
- Non-porous
- Surface protection
- Made from recycled rubber and SBR

Benefits

- Avoids bacteria build-up
- Easy to clean
- Dries quickly
- Reduces chance of injury

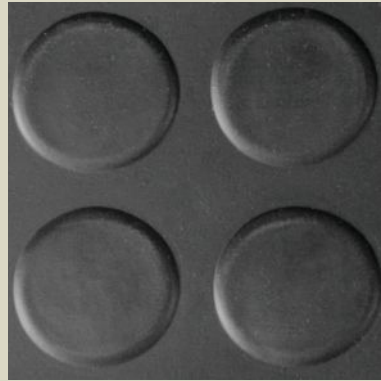

RMDOT349 Round Dot
49' x 3.25' x 0.15" • 189 lbs. • 1 pk

Applications

- Hallways, corridors, etc.
- High traffic areas
- Behind retail counters

Features

- Long lengths
- Non-porous
- Surface protection
- Anti-slip
- Made from recycled rubber and SBR

Benefits

- Avoids bacteria build-up
- Easy to clean
- Dries quickly
- Reduces chance of injury

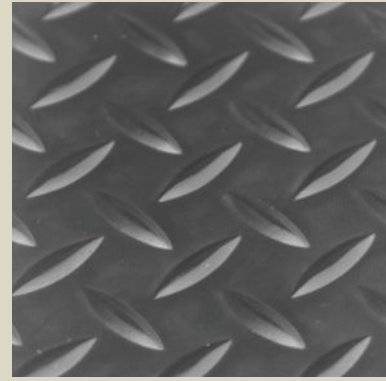

RMDIA380 Check Plate
80' x 3.25' x 0.125" • 211 lbs. • 1 pk

Applications

- Hallways, corridors, etc.
- High traffic areas
- Doors and walkways

Features

- Long lengths
- Non-porous
- Surface protection
- Anti-slip metal pattern
- Made from recycled rubber and SBR

Benefits

- Avoids bacteria build-up
- Easy to clean
- Dries quickly
- Reduces chance of injury



RM3DISP

Free display with purchase of 3 bulk rolls.



Utility knife and 2 x 4 board are not included.

RM3DISP 3 Roll Mat Dispenser with Metal Cutting Guide

60.25" x 30.75" x 59.25" • 1 pk
95 lbs. • Bar length 60.25"

- Display allows you to cut to your desired size
- Easily cut a straight line using a utility knife to eliminate excess waste
- Display holds a maximum of 1,500 lbs.
- 2 x 4 board is not included



Mat Specifications (for all Rolled Rubber Mats)

Hardness.....	65 Shore A Nominal
Density	1500 kg/m3
Elongation	> = 180%
Shearing Strength.....	< 0.60 (N/mm3)
Temperature Stability.....	30/70
Compression Recovery	After 22 hours 75%
Tensile Strength	450 PSI
Critical Radiant Flux.....	0.11 watts/sq
Tear Resistance	150 ppi



HOT-SHOT® Products

Hot-Shot® continues to be the industry standard and brand of choice for electric livestock prods that assist in the movement and transportation of livestock. Hot-Shot® electric livestock prods have been manufactured for over 75 years and continue to be proudly made in the USA.



The DuraProd® is available in alkaline or rechargeable battery models. 1 year warranty.* Retail display packaging shown to the left.



- The manufacturing process has been developed and refined over the past seven decades and is precise and complex.
- Our stringent and time-tested quality systems are engineered into each and every prod. We carefully test 100% of our units using sophisticated electronic equipment before they are shipped.
- All prods are tested for current and voltage draw, output voltage, output energy, pulse rate (frequency) and a calculated performance ratio based on these measurements to a standard range. Units that fall outside of the range are scrapped.
- We run destructive testing on our Hot-Shot® prods to ensure they continue to meet our high performance requirements long after customers purchase them.
- We have a dedicated Engineering and Quality Assurance teams that work together to develop product quality plans and drive these quality requirements into the manufacturing process. All of these resources are focused on understanding the science behind Miller's product performance and use the Lean Six Sigma based DMAIC (Define, Measure, Analyze, Improve and Control) to drive product performance and sustain these results.

Battery Operated DuraProd®

ITEM	DESCRIPTION	SIZE	CASE PACK
DX36	Dura with RH36 €	L 29" x W 7" x H 3"	6 pk
DX48	Dura with RH48 €	L 41" x W 7" x H 3"	6 pk
DX32	Dura with FX32 €	L 25" x W 7" x H 3"	6 pk
DX42	Dura with FX42 €	L 34.75" x W 7" x H 3"	6 pk
HUDX	Dura Handle with Batteries €	L 14" x W 4.5" x H 3"	6 pk
HUDXB	Dura Handle with Batteries Bulk €	L 11.25" x W 2.25" x H 3"	6 pk



SHAPED BY EXPERIENCE.



Rubber overmolded handle reduces fatigue



Snap on battery pack for fast battery changes



Built-In safety switch prevents accidental use



Redesigned shaft nut increases gripping surface and durability

DuraProd® features include: sealed circuitry, patented design technology to reduce feedback shock, handle with rubber grip, oversized trigger, and hand guard. In addition, we test each DuraProd® using six proprietary measures to ensure reliability.



HUDXR



DXR32



DXRKIT
Includes: DXRBP, R12, R110 & Charger Base



DXRC1



DXRBP

RH for Fiberglass shaft • FX for Flexible shaft Note: All dimensions below are for product in retail packaging. *Warranty is on electronics only. It does not include shaft, case breakage, any form of physical damage or damage due to normal wear and tear. No electric livestock prods or components may be exported or re-exported without prior U.S. government authorization.

Rechargeable DuraProd®

ITEM	DESCRIPTION	SIZE	CASE PACK
DXR36	Dura Rechargeable with RH36	L 29" x W 7" x H 3"	6 pk
DXR48	Dura Rechargeable with RH48	L 41" x W 7" x H 3"	6 pk
DXR32	Dura Rechargeable with FX32	L 25" x W 7" x H 3"	6 pk
DXR42	Dura Rechargeable with FX42	L 34.75" x W 7" x H 3"	6 pk
HUDXR	Dura Rechargeable Handle	L 14" x W 4.5" x H 3"	6 pk
HUDXRB	Dura Rechargeable Handle Bulk	L 11.25" x W 2.25" x H 3"	6 pk
DX1	Dura Motor	L 14" x W 4.5" x H 3"	1 pk
DXABP	Dura Alkaline Battery Pack	L 11.25" x W 5.625" x H 2.5"	1 pk
DXRBP	Dura Rechargeable Battery Pack	L 11.25" x W 5.625" x H 2.5"	1 pk
DXRKIT	Dura Rechargeable Kit	L 10.375" x W 10.125" x H 3.25"	1 pk
DXRC1	Dura Base with R110 Adaptor	L 5.625" x W 2.5" x H 11.25"	1 pk
DXRC2	Dura Base with R12 Adaptor	L 5.625" x W 2.5" x H 11.25"	1 pk

Limited Duration DuraProd®

Features built in one-second technology that delivers one second of output with each press of the switch. Conforms to the most stringent guidelines regarding the humane treatment of livestock. The Limited Duration DuraProd® operates on 4 size "C" batteries and includes a LED light that indicates when the power is surging.



Patented Design

ITEM	DESCRIPTION	SIZE	CASE PACK
DXD36	Limited Duration with RH36	L 29" x W 7" x H 3"	6 pk
DXD48	Limited Duration with RH48	L 41" x W 7" x H 3"	6 pk
DXD32	Limited Duration with FX32	L 25" x W 7" x H 3"	6 pk
DXD42	Limited Duration with FX42	L 34.75" x W 7" x H 3"	6 pk
HUDXD	Limited Duration Handle with Batteries	L 14" x W 4.5" x H 3"	6 pk
DXD1	Limited Duration Motor	L 14" x W 4.5" x H 3"	1 pk





The Green One® Provides unparalleled performance in all conditions, especially on wet animals. Proven and preferred by commercial livestock haulers. Features sealed motor. 1 year warranty.*

HS2000®



The Red One® Effective prod at an economical price. Features sealed motor. 1 year warranty.*

SABRE-SIX®

Battery Operated Prods

Available as complete units with Fiberglass or Flex Shaft. To create prods shorter than 32" or longer than 48", handle and shaft must be ordered separately.

ITEM	DESCRIPTION	SIZE	CASE PACK
HS2000® The Green One®			
HS36	HS2000® with RH36	L 6.875" x W 2.875" x H 28.875"	6 pk
HS48	HS2000® with RH48	L 6.875" x W 2.875" x H 40.875"	6 pk
HS32	HS2000® with FX32	L 6.875" x W 2.875" x H 24.625"	6 pk
HS42	HS2000® with FX42	L 6.875" x W 2.875" x H 34.625"	6 pk
HUHSC	HS2000® Handle Unit Only in Clamshell	L 4.5" x W 3" x H 14"	6 pk
SABRE-SIX® The Red One®			
SS36	SABRE-SIX® with RH36	L 6.875" x W 2.875" x H 28.875"	6 pk
SS48	SABRE-SIX® with RH48	L 6.875" x W 2.875" x H 40.875"	6 pk
SS32	SABRE-SIX® with FX32	L 6.875" x W 2.875" x H 24.625"	6 pk
SS42	SABRE-SIX® with FX42	L 6.875" x W 2.875" x H 34.625"	6 pk
HUSC	SABRE-SIX® Handle Unit Only in Clamshell	L 4.5" x W 3" x H 14"	6 pk

Available in CLAMSHELL PACKAGING!



HS36

SS32

Available in Classic Packaging (no clamshell)

HUHS HS2000® Handle Unit Only • 6 pk

L 3" x W 2.5" x H 9" • 6 pk

HS1 HS2000® Replacement Motor • 1 pk

L 3.75" x W 1.25" x H 6" • 1 pk

HUS SABRE-SIX® Handle Unit Only • 6 pk

L 3" x W 2.5" x H 9" • 6 pk

SS1 SABRE-SIX® Replacement Motor • 1 pk

L 3.75" x W 1.25" x H 6" • 1 pk

PM POWER-MITE®

L 6.375" x W 2" x H 1.25" • 6 pk

Light and compact - fits easily into your pocket. Moisture-resistant on/off switch to reduce chance of feedback shock. Includes two 9V alkaline batteries.

PMH POWER-MITE® Leather Holster

L 1.75" x W 3.125" x H 8.5" • 1 pk

ALKDP High Amp Alkaline Size C Batteries (6 batteries)

L 6.125" x W 1" x H 2" • 12 pk

Long lasting and high power batteries formulated specially for use in Hot-Shot® Prods.



HUHSC

HUSC



PMH



ALKDP



PM

RH for Fiberglass shaft • FX for Flexible shaft Note: All dimensions above are for product in retail packaging. *Warranty is on electronics only. It does not include shaft, case breakage, any form of physical damage or damage due to normal wear and tear. No electric livestock prods or components may be exported or re-exported without prior U.S. government authorization.



Rechargeable Prods

Available as complete units with Fiberglass or Flex Shaft. To create prods shorter than 32" or longer than 48", handle and shaft must be ordered separately.

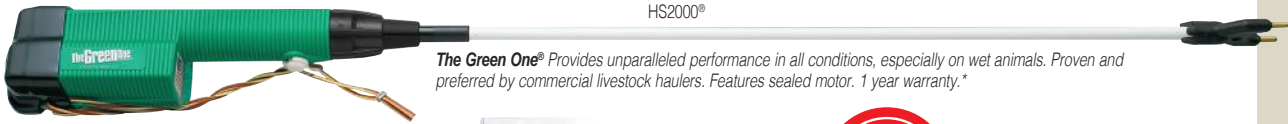

The Green One® Provides unparalleled performance in all conditions, especially on wet animals. Proven and preferred by commercial livestock haulers. Features sealed motor. 1 year warranty.*

HS2000® The Green One®

HSR36 HS2000® Rechargeable with RH36 🇺🇸
L 6.875" x W 2.875" x H 28.875" • 6 pk
Includes the Rechargeable Battery Pack (RBP).

HSR48 HS2000® Rechargeable with RH48 🇺🇸
L 6.875" x W 2.875" x H 40.875" • 6 pk
Includes the Rechargeable Battery Pack (RBP).

HSR32 HS2000® Rechargeable with FX32 🇺🇸
L 6.875" x W 2.875" x H 24.625" • 6 pk
Includes the Rechargeable Battery Pack (RBP).

HSR42 HS2000® Rechargeable with FX42 🇺🇸
L 6.875" x W 2.875" x H 34.625" • 6 pk
Includes the Rechargeable Battery Pack (RBP).

HUHSRC HS2000® Rechargeable Handle Unit Only in Clamshell 🇺🇸
L 4.5" x W 3" x H 14" • 6 pk



HUHSRC



HSR32



Can be used on the HS2000® and SABRE-SIX®

RBP

RBP Rechargeable Battery Pack

L 5" x W 2.5" x H 3" • 1 pk

Closes securely with flip top. LED light lets you know it's charging. Charge it with our 12 volt auto charger, 120 volt wall charger or USB charger - all sold separately.

R12 12 Volt Auto Charger for RBP

L 1.5" x W 1" x H 6.5" • 1 pk

R110 120 Volt Wall Outlet Charger for RBP

L 1.5" x W 2.5" x H 4" • 1 pk

NEW! RUSBHSUS USB Charger Hot-Shot U.S. Plug

USB Charger for Hot-Shot® brand rechargeable livestock prods. Includes power cord and wall charger unit. For use only with Hot-Shot® Brand livestock prods.

L 5" x W 7" x H 1.5" • 1 pk



R110



R12

RUSBHSUS



Available in Classic Packaging (no clamshell)

HUHSR HS2000® Rechargeable Handle Unit Only 🇺🇸
L 3" x W 2.5" x H 9" • 6 pk

HS1 HS2000® Replacement Motor 🇺🇸
L 3.75" x W 1.25" x H 6" • 1 pk

Hot-Shot® Shafts

Hot-Shot® is the only brand of prods to offer two styles of shafts. Choose from the traditional rigid fiberglass (RH) or the durable flexible shaft (FX).

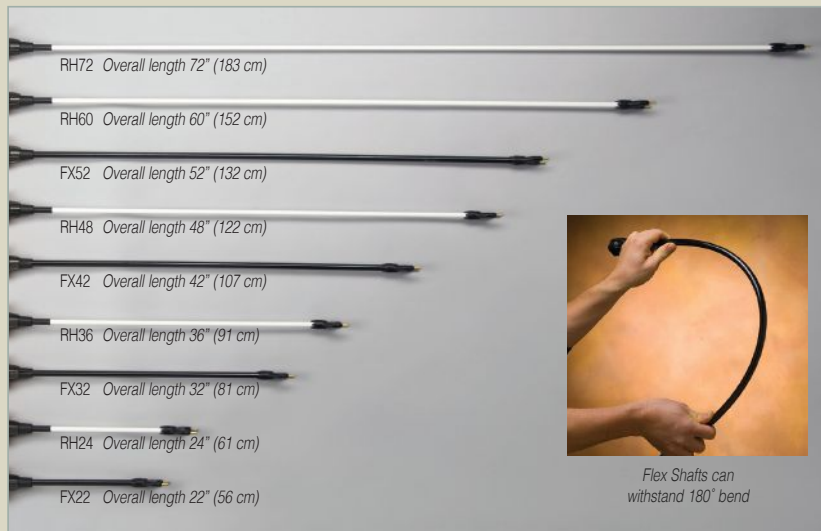

RH72 Overall length 72" (183 cm)

RH60 Overall length 60" (152 cm)

FX52 Overall length 52" (132 cm)

RH48 Overall length 48" (122 cm)

FX42 Overall length 42" (107 cm)

RH36 Overall length 36" (91 cm)

FX32 Overall length 32" (81 cm)

RH24 Overall length 24" (61 cm)

FX22 Overall length 22" (56 cm)



Flex Shafts can withstand 180° bend

Lengths shown above are when attached to prod and include length of prod handle

Fiberglass Shafts
Available in 24", 36", 48", 60" and 72"

RH24 24" Fiberglass Shaft 🇺🇸
L 15.75" x W 1.75" x H 1.375" • 6 pk

RH36 36" Fiberglass Shaft 🇺🇸
L 27.75" x W 1.75" x H 1.375" • 6 pk

RH48 48" Fiberglass Shaft 🇺🇸
L 39.75" x W 1.75" x H 1.375" • 6 pk

RH60 60" Fiberglass Shaft 🇺🇸
L 51.75" x W 1.75" x H 1.375" • 6 pk

RH72 72" Fiberglass Shaft 🇺🇸
L 63.75" x W 1.75" x H 1.375" • 6 pk

Flex Shafts
Available in 22", 32", 42" and 52"

FX22 22" Flex Shaft 🇺🇸
L 13.5" x W 1.75" x H 1.375" • 6 pk

FX32 32" Flex Shaft 🇺🇸
L 23.5" x W 1.75" x H 1.375" • 6 pk

FX42 42" Flex Shaft 🇺🇸
L 33.5" x W 1.75" x H 1.375" • 6 pk

FX52 52" Flex Shaft 🇺🇸
L 43.5" x W 1.75" x H 1.375" • 6 pk

RH for Fiberglass shaft • FX for Flexible shaft Note: All dimensions above are for product in retail packaging. *Warranty is on electronics only. It does not include shaft, case breakage, any form of physical damage or damage due to normal wear and tear. No electric livestock prods or components may be exported or re-exported without prior U.S. government authorization.



Non Electric

Sorting Poles

For years, a common tool for sorting livestock of all types. Features a comfortable golf-style grip and vinyl covering for protection and easy cleaning. Available in 42", 48" and 54".

SPL42 42" Sorting Pole

L 42" x W 1.125" x H 1.125" • 12 pk

SPL48 48" Sorting Pole

L 48" x W 1.125" x H 1.125" • 12 pk

SPL54 54" Sorting Pole

L 54" x W 1.125" x H 1.125" • 12 pk

Sorting Paddles

Animals respond to the sound of the BB's inside the paddle. Creates a visual barrier to guide livestock. Features a comfortable golf-style grip and vinyl covering for protection and easy cleaning. Available in 42" and 48" lengths, and in: ■ ■ ■

PAD42 42" Paddle

L 42" x W 6.25" x H 1.125" • 6 pk

PAD48 48" Paddle

L 48" x W 6.25" x H 1.125" • 6 pk

V-Tip Sorting Paddles

The V-Tip design helps livestock handlers get into tight corners and prevents baby pigs from getting around the paddle. Features a "wear edge" for added durability. Available in 42" and 48". Available in: ■

PAD42V 42" Paddle V-Tip

L 42" x W 6.25" x H 1.125" • 6 pk

PAD48V 48" Paddle V-Tip

L 48" x W 6.25" x H 1.125" • 6 pk

Show Sticks

Great for use in showing horses, cattle and other animals. Earns a quick response without hurting the animal. Features a durable aluminum hook and comfortable golf-style grip. The lightweight aluminum shaft locks at 38", 44" and 50" with push-button locking mechanism. Collapses to 29" for storage. Available in: ■ ■ ■

SHO Sho-Stik

L 50" x W 1.125" x H 1.125" • 6 pk



Livestock Prods

The Springer Magrath® Stock Prod is time-tested and proven on the road and in the stockyards for over 40 years. It's a leader for handling and moving livestock effectively and efficiently. The clog-free, no-ground tip rotates to any position. The durable, reliable solid-state electronics system transmits very low current to the animal yet delivers a strong, instantaneous sensation. Grooved finger guide allows finding the switch by feel, even with gloved hands; rubber switch insulator prevents feedback through the grip. Precious metal battery contacts won't corrode, and heavy coil spring assures firm battery contact. High-energy, longer lasting alkaline batteries included. Housed in a tough, structural-grade resin case for years of reliable service.



200PPWOB
200PP

200PPWOB
Power Pak - No Batteries 🇺🇸
L 10.75" x W 2" x H 4" • 6 pk

200PP
Power Pak - 4 Alkaline Batteries 🇺🇸
L 10.75" x W 2" x H 4" • 6 pk



SSP

BATT12PK Alkaline Size C Batteries

L 4" x W 2" x H 3" • 1 pk
12-pack of high-energy, longer lasting alkaline batteries designed specifically for use in Springer Magrath® Stock Prods.

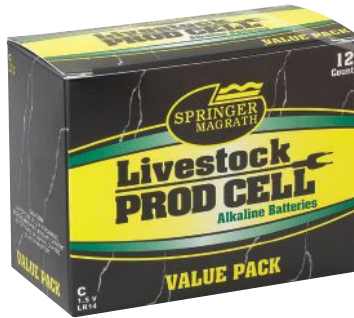

BATT12PK

SSP Stock Prod End Boot ⚡

L 4" x W 2.5" x H 2.125" • 1 pk
Covers the handle end on the Stock Prod Power Pak Handle. Protects the battery compartment from moisture and exposure to the elements.

NEW! 200PPC Power Pak In Clamshell 🇺🇸

L 5" x W 2" x H 14" • 6 pk
Power Pak Handle Assembly for Springer Magrath® Stock Prod.



200PPC and 200PPRC

NEW! 200PPRC Power Pak Rechargeable In Clamshell

L 5" x W 2" x H 14" • 6 pk
Power Pak Handle Assembly with Rechargeable Battery Stick for Springer Magrath® Stock Prod.

NEW! RUSBSPUS USB Charger Springer U.S. Plug

L 5" x W 7" x H 1.5" • 1 pk
USB Charger for Springer Magrath® brand rechargeable livestock prods. Includes power cord and wall charger unit. For use only with Springer Magrath® brand livestock prods.

Now in Clamshell Packaging!



RUSBSPUS

NEW!



PSTKR12C

NEW! PSTKR12C Springer Rechargeable Battery Stick With 12V Charger

L 6.5" x W 10" x H 2" • 6 pk
Upgrade your Springer Magrath Power Pak Handle from battery-powered to rechargeable using this Battery Stick. This battery stick is capable of 300-500 battery cycles, which is the equivalent of 1,000 alkaline batteries. Includes 12V Car Charger.

Livestock Prod Shafts

The clog-free, no-ground tip rotates to any position. Available in 9", 22", 34" and 44" lengths.

9SA 9" Shaft ⚡
L 14.5" x W 2" x H 1.5" • 6 pk



22SA 22" Shaft ⚡
L 27.125" x W 2" x H 1.5" • 6 pk



34SA 34" Shaft ⚡
L 39" x W 2" x H 1.5" • 6 pk



44SA 44" Shaft ⚡
L 49" x W 2" x H 1.5" • 6 pk



* Warranty is on electronics only. It does not include shaft, case breakage, any form of physical damage due to normal wear & tear. No electric livestock prod or components may be exported or re-exported without prior U.S. government authorization.



Fluidfeeders

Fluidfeeders provide a practical, easy-to-use tool for providing fluids and nourishment to calves that can't or won't nurse. The esophageal probe is the correct size for calves and, if used properly, the probe's size and shape do not allow it to be inserted into the trachea, reducing the danger of getting fluid into lungs and drowning the calf. The easy-to-handle 2-quart tube makes using the fluidfeeder a simple, one-person operation. When used properly, the rate of flow is slow enough to cause the calf to form saliva freely, which is necessary for proper digestion. Heavy-duty tube resists punctures and tears and remains flexible down to 0 degrees F. (-18 degrees C.). Bottle collapses without venting, and check valve keeps air out as liquid leaves the bottle. Bottle, tube, and probe are easy to clean.

Crimp Valve Fluidfeeders

Design allows user easy control of fluid flow.



50SSFF 2 Quart Fluidfeeder with Stainless Steel Probe

L 32" x W 9.5" x H 4" • 6 pk

Durable hardened stainless-steel probe lasts for years.



50PLFF 2 Quart Fluidfeeder with Plastic Probe

L 31.5" x W 9.5" x H 4" • 6 pk

Durable plastic probe resists burrs that can cut the throat and cause infection.



50PLFFNA 2 Quart Fluidfeeder with Plastic Probe & Nipple

L 31.5" x W 9.5" x H 4" • 6 pk

Durable plastic probe resists burrs that can cut the throat and cause infection. Also comes with alternative nipple end for mouth feeding.



50PLGLFF 1 Gallon Fluidfeeder with Plastic Probe

L 31" x W 6.25" x H 5.125" • 6 pk

Durable plastic probe resists burrs that can cut the throat and cause infection.



50SSGLFF 1 Gallon Fluidfeeder with Stainless Steel Probe

L 31" x W 6.25" x H 5.125" • 6 pk

Durable hardened stainless-steel probe lasts for years.

No-Crimp Gravity Fluidfeeders

Gravity controls fluid flow.



50PLNSFF 2 Quart Fluidfeeder with Plastic Probe

L 30.25" x W 9.5" x H 4" • 6 pk

Durable plastic probe resists burrs that can cut the throat and cause infection.



50PLNSFFNA 2 Quart Fluidfeeder with Plastic Probe & Nipple

L 30.25" x W 9.5" x H 4" • 6 pk

Durable plastic probe resists burrs that can cut the throat and cause infection. Also comes with alternative nipple end for mouth feeding.



101NFF 2 Quart Nipple Fluidfeeder

L 17" x W 9.5" x H 4" • 1 pk

Comes with nipple end for mouth feeding.

101NA Nipple Attachment

L 4" x W 2.25" x H 2.25" • 1 pk

Fits on any Springer Magrath® Fluidfeeder to allow mouth feeding of fluids to young calves that are unable to nurse from a cow.



Bolus Gun

The safe, easy way to administer medication to cattle of all sizes, eliminating coughing and spitting out. The Springer Magrath® Bolus Gun is made of industrial-quality aluminum that holds up to rugged use and resists sharp edges that can cut and cause infections. Rounded leading edge allows easy insertion. Can administer up to five 1-lb boluses at one time.

480NBG Bolus Gun

L 21.5" x W 2.25" x H 2.25" • 1 pk



480NBG

Cattle Pump System

Includes everything needed to administer accurate dosage of both light and heavy-viscosity fluids to adult animals weighing 300 to over 900 lbs. A must for post-calving drenches and tonics, and for administering electrolytes, nutrient mixes, mineral oil, or medications. Effective for hydrating cattle for better response to antibiotics or vaccinations. Professional-quality system designed to be operated by one person, with a pump that requires only seven strokes per gallon.

Features a flexible stainless-steel esophageal probe that utilizes the natural extended neck position of the bovine to bypass the trachea and deliver the probe into the stomach, with a unique teardrop end for easy passage. Attached nose lead effectively holds the probe in place; built-in stop action reduces chances of regurgitation. System includes probe and attached nose lead, chrome-plated brass pump with hand grip, and 6' oil-resistant hose with screw-on brass fittings, all in a canvas carrying case.



300CPS 300 Cattle Pump System ✦
L 36" x W 16" x H 3.5" • 1 pk
For cattle weighing 300 to 900 lbs.

500CPS 500 Cattle Pump System ✦
L 59.5" x W 16" x H 3.5" • 1 pk
For adult cattle weighing over 900 lbs.

Cattle Pump Probes

Esophageal probe made of flexible stainless-steel. Probe features unique teardrop end for easy insertion.

300CSPR CPS 300 Probe ✦
L 36" x W 2.5" x H 3" • 1 pk
For cattle weighing 300 to 900 lbs.

500CSPR CPS 500 Probe ✦
L 60" x W 2.5" x H 3" • 1 pk
For adult cattle weighing over 900 lbs.

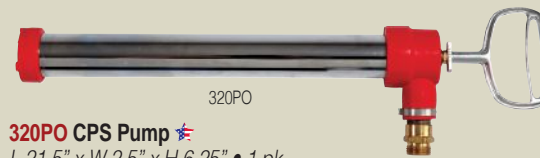

320PO CPS Pump ✦
L 21.5" x W 2.5" x H 6.25" • 1 pk
Chrome-plated brass pump with hand grip. Fits both the 300CPS and 500CPS Cattle Pump Systems.

Obstetrical Calf Straps

Obstetrical Straps are easier on both cow and calf than chains. The 1" width spreads pulling tension over a wider area of the calf's legs to help prevent bone fractures and soft-tissue injury. Made of soft yet sturdy, washable nylon webbing with stainless-steel D rings. Bright teal color that is easy to find. Can be used with or without a mechanical tension device. Available in three lengths.



10430S 30" Nylon OB Strap
L 32.5" x W 1" x H 0.25" • 1 pk

10460S 60" Nylon OB Strap
L 62.5" x W 1" x H 0.25" • 1 pk

10452CS 52" Nylon / Chain OB Strap
L 52.5" x W 1" x H 0.5" • 1 pk
Includes 16" chain insert.

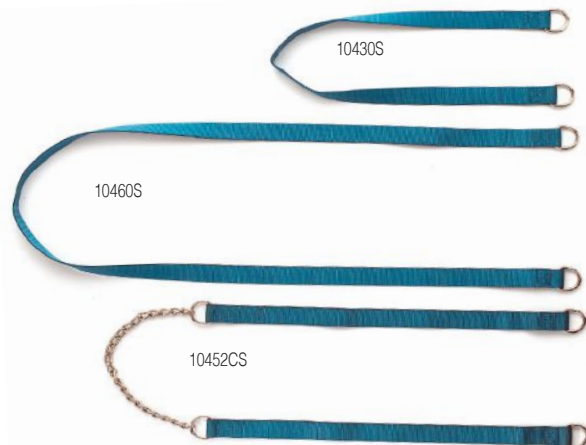

Transfer Needle

The easy, sanitary solution for transferring fluids from one vial to another. A great tool for mixing components or rehydrating dried vaccines. 14-gauge stainless steel, double-pointed cannula is tapered on both ends, with a flat metal thumb saddle that can be used even with gloves.

840MTN Transfer Needle ✦
L 3" x W 0.56" x H 0.31" • 1 pk



Orphan-No-More™

A simple, easy-to-use, and effective way to help assure calf and lamb adoption by natural or foster mothers. Orphan-No-More™ works by masking the odor of the calf or lamb with a more intense odor that is highly attractive to cows and ewes. Made of 95% natural animal protein products. Orphan-No-More™ has been field tested on both cattle and sheep, and has proven effective at cow-calf and ewe-lamb grafting. 9-Oz jar contains enough powder for four to five calves or lambs.

106ONM 9 Oz Bottle Orphan-No-More™ ✦
L 2.75" x W 2.75" x H 6" • 12 pk



106ONM



Heated Products

API® has remained a trusted name in heated products for over 65 years. With a wide variety of products spanning the agricultural, pet, wild bird, and pond markets, API® has the right product for all seasons. From the revolutionary all-season UL-certified LOCKNDRY® extension cord to a broad range of de-icing units, API® not only provides quality products but also highly efficient technology to the hobbyist market. **Our selection of API® farm and ranch products starts on page 58. Our selection of API® pet products starts on page 63.**



Heated Buckets & Tubs

API® Heated Buckets are constructed of high-quality, resilient plastic to withstand low temperatures without cracking. Thermostatic control with over-temperature protection ensures that it will keep water ice-free to low temperatures.

9HB Heated 9 Quart Bucket

50 Watts, 120 Volts Ⓢ

L 11.25" x W 11.25" x H 9.375" • 6 pk

Perfect midsize bucket, especially suited for medium to large sized dogs or other similar sized animals. Includes 6-foot anti-chew cord. LOCKNDRY® compatible. Patented. cULus Listed.

10FB Heated 10 Quart Flat Back Bucket

70 Watts, 120 Volts Ⓢ

L 13.625" x W 12" x H 9.625" • 5 pk

Perfect for those who need a smaller flat back bucket. It hangs flush against the wall. Includes a patented sliding storage door on the bottom of the bucket to stow the 6-foot anti-chew cord during summer use. LOCKNDRY® compatible. Patented. cCSAus Listed.

20FB Heated 20 Quart Flat Back Bucket

115 Watts, 120 Volts Ⓢ

L 16.25" x W 14.25" x H 12.375" • 6 pk

The flat back design and over-sized metal handle allow this bucket to hang flush against a wall. Patented design features a bottom compartment to stow the 6-foot anti-chew cord during summer use. LOCKNDRY® compatible. Patented. cULus Listed.

16HB Heated 16 Gallon Bucket

260 Watts, 120 Volts Ⓢ

L 23.25" x W 21.5" x H 16.75" • 4 pk

Designed to accommodate multiple animals. Features strong and sturdy molded handles. Includes 6-foot anti-chew cord. LOCKNDRY® compatible. Patented. cULus Listed.



DT250, DT500, W250 & W500

Bucket De-Icers

DT250 Bucket/Utility De-Icer

250 Watts, 120 Volts Ⓢ

L 4.75" x W 4.75" x H 1.125" • 6 pk

Uses multiple thermostats for optimized control. The low-profile, finned design provides a large surface area to run cooler while putting out the same amount of heat as conventional de-icers resulting in less mineral buildup and longer life. Recommended for up to 30 gallons of water. Includes 6-foot anti-chew cord. LOCKNDRY® compatible. cULus Listed.

DT500 Bucket/Utility De-Icer

500 Watts, 120 Volts Ⓢ

L 4.75" x W 4.75" x H 1.125" • 6 pk

Same as the DT250 but 500 Watts, 120 Volts. Recommended for up to 70 gallons of water. Includes 6-foot anti-chew cord. LOCKNDRY® compatible. cULus Listed.

W250 Auto Waterer De-Icer

250 Watts, 120 Volts Ⓢ

L 4.75" x W 4.75" x H 1.125" • 6 pk

Equipped with aluminum feet it is specially designed for use in automatic waterers/drinkers. Features a non-stick coating and is safe for use in plastic buckets or tanks. Recommended for up to 30 gallons of water. Includes 6-foot anti-chew cord. LOCKNDRY® compatible. cULus Listed.

W500 Auto Waterer De-Icer

500 Watts, 120 Volts Ⓢ

L 4.75" x W 4.75" x H 1.125" • 6 pk

Same as the W250 but 500 Watts, 120 Volts. Recommended for up to 70 gallons of water. Includes 6-foot anti-chew cord. LOCKNDRY® compatible. cULus Listed.



Bucket Heaters



77UH Utility Heater
500 Watt, 120 Volts

L 3.25" x W 3" x H 9.875" • 6 pk
This utility heater is a versatile unit made of heavy-gauge steel with an attractive baked-on enamel finish. Though not immersible, this utility heater can be used under metal buckets, fountains, or inside various enclosures. With an adjustable and replaceable thermostat, the utility heater's compact design has a wide range of uses. Includes 12" cord. LOCKNDRY® compatible.

LOCKNDRY
COMPATIBLE



742G Bucket Heater
1000 Watts, 120 Volts

L 2.875" x W 2.875" x H 17.5" • 6 pk
Designed to heat water as opposed to de-icing water. A stainless steel guard protects the durable heating element that will heat water past 150 degrees F towards boiling, depending on the bucket's volume and insulation. It comes with a 6-foot cord and is designed to rest easily inside a 5 gallon bucket. The heater is thermostatically controlled with over-temperature protection. For use in water only. Includes 6-foot cord. LOCKNDRY® compatible. UL Listed. CSA Listed.

See page 16 for compatible
Little Giant® Buckets



250D Pail & Bird Bath De-Icer
200 Watts, 120 Volts

L 2.75" x W 7.75" x H 0.875" • 6 pk
De-ices up to 15 gallons. Submersible de-icer features thermostatic control and a stainless steel guard for safety. An adjustable clamp is included to attach the unit to the container. Includes 6-foot anti-chew cord. LOCKNDRY® compatible. cULus Listed. CSA Listed.

Tank De-Icers

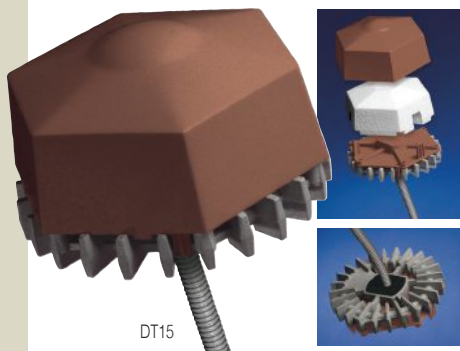

DT15 3-in-1 De-Icer 1500 Watts, 120 Volts

L 7" x W 7" x H 4.375" • 6 pk
Easily converts to floating, sinking or drain-plug de-icer. To use as a sinking de-icer, simply remove the cover and float, turn the unit over to rest on its sturdy feet, or use the patented drain plug adapter to route the cord through the drain hole. Multiple, dedicated thermostats separately monitor water and heating element temperatures to provide efficient and safe operation. The sturdy, finned base spreads the heat to make the unit run cooler to the touch while still putting the maximum amount of heat into the water. Cooler operation and non-stick coating resists mineral buildup. Can safely operate in any plastic or metal tank without the use of a guard. Recommended for 100-300 gallons of water. 6-foot anti-rub cord. Patented. cULus Listed.



7521 Floating De-Icer
1500 Watts, 120 Volts

L 8.75" x W 8.75" x H 3.25" • 6 pk
Thermostatic control coupled with thermal feedback protects the unit from overheating. Positioning the thermostat above the heating element ensures safety in low-water conditions. The float is completely enclosed in a plastic housing and will not sink over time. Recommended for 100-300 gallons of water. 6-foot anti-rub cord. LOCKNDRY® compatible. cULus Listed.

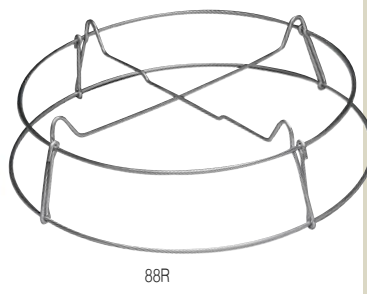

7621 Floating De-Icer
1000 Watts, 120 Volts

L 8.75" x W 8.75" x H 3.25" • 6 pk
Same as the 7521 but 1000 watts, 120 volts. Recommended for 70-100 gallons of water. 6-foot anti-rub cord. LOCKNDRY® compatible. cULus Listed.

88R Galvanized De-Icer Guard

L 14.25" x W 14.25" x H 3.75" • 6 pk
May be used with floating, sinking or 2-in-1 de-icers. Guard is specially designed to protect rubber, plastic or structural-foam tanks.

See page 24 for compatible
Little Giant® Stock Tanks.

521G Floating De-Icer with Galvanized Guard
1500 Watts, 120 Volts

L 14.25" x W 14.25" x H 6" • 6 pk
Thermostatic control coupled with thermal feedback protects the unit from overheating. Positioning the thermostat above the heating element ensures safety in low-water conditions. The float is completely enclosed in a rugged, plastic housing and will not sink over time. The galvanized guard is specially designed to protect rubber, plastic or structural-foam tanks. Recommended for 100-300 gallons of water. 6-foot anti-rub cord. LOCKNDRY® compatible. cULus Listed.

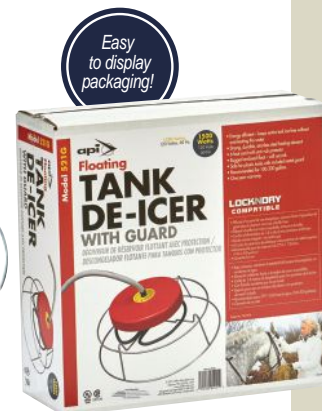

API® Heated Products



Tank De-Icers (Continued)



15N & 10N

15N Sinking De-Icer 1500 Watts, 120 Volts

L 14.25" x W 14.25" x H 6.25" • 6 pk

Operates at the bottom of the tank where it is less likely to be disturbed by livestock. Thermostatic control coupled with thermal feedback protects the unit from overheating. Positioning the thermostat above the heating element ensures safety in low-water conditions. Each unit comes complete with a galvanized wire guard for use in plastic tanks. Recommended for 100-300 gallons of water. 6-foot anti-rub cord. LOCKNDRY® compatible. UL Listed. CSA Listed.

10N Sinking De-Icer 1000 Watts, 120 Volts

L 14.25" x W 14.25" x H 6.25" • 6 pk

Same as the 15N but 1000 Watts, 120 Volts. Recommended for 70-100 gallons of water. 6-foot anti-rub cord. LOCKNDRY® compatible. UL Listed. CSA Listed.

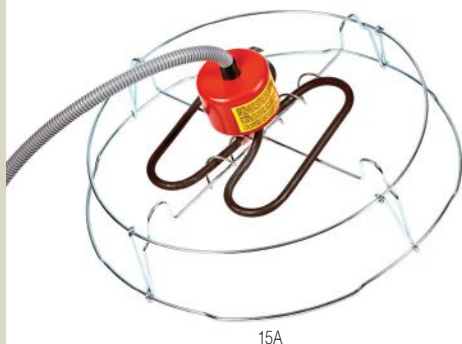

15A

15A 2-in-1 Sinking De-Icer 1500 Watts, 120 Volts

L 14.25" x W 14.25" x H 6.25" • 6 pk

Can be used as either a sinking or drain-plug de-icer. The power cord plug is specially designed to fit through a 3/4" drain hole, and a patented drain plug adapter seals around the cord to provide care-free routing. Operates at the bottom of the tank where it is less likely to be disturbed by livestock, protecting both equipment and animals. Thermostatic control coupled with thermal feedback protects the unit from overheating. Positioning the thermostat above the heating element ensures safety in low-water conditions. 6-foot anti-rub cord. Recommended for 100-300 gallons of water. Patented.



15DP

LOCKNDRY
COMPATIBLE

Easy
to display
packaging!



15DP Drain Plug De-Icer 1500 Watts, 120 Volts

L 18" x W 6.5" x H 3.25" • 6 pk

For Rubbermaid® tanks only. Mounts securely into the tank drain hole to keep the heating element away from livestock. Has a butterfly heating element and is designed to mount into the larger drain hole found on some Rubbermaid® tanks. Recommended for 100-300 gallons of water. 6-foot anti-rub cord. LOCKNDRY® compatible. Patented. cULus Listed.

See page 24 for compatible
Little Giant® Stock Tanks.



DTS15

DTS15 Sinking De-Icer 1500 Watts, 120 Volts

L 7" x W 7" x H 2.75" • 6 pk

This energy efficient sinking de-icer keeps your entire tank ice-free without overheating the water. Safe for animals, this de-icer includes a durable PTFE coating for easy cleaning. The large, finned base runs cooler than conventional de-icers, making it safe for plastic or metal tanks alike. Recommended for 100-300 gallons of water. 6-foot anti-rub cord. LOCKNDRY® compatible. cULus Listed.



Plug fits through all drain holes 3/4" diameter or larger



2002DP & 99DP

LOCKNDRY
COMPATIBLE

Easy
to display
packaging!

2002DP Universal Drain Plug De-Icer - 1500 Watts, 120 Volts

L 12.5" x W 6" x H 3.25" • 6 pk

Mounts securely into the tank drain hole to keep the heating element away from livestock. Specially designed plug to fit through all drain holes 3/4" diameter or larger. Recommended for 100-300 gallons of water. 6-foot anti-rub cord. Patented. cULus Listed.

99DP Universal Drain Plug De-Icer 1500 Watts, 120 Volts

L 6.125" x W 13" x H 3.25" • 6 pk

Mounts securely into the tank drain hole to keep the heating element away from livestock. Includes a patented cord that detaches to pass through a drain hole 3/4" or larger. Recommended for 100-300 gallons of water. 6-foot anti-rub cord. LOCKNDRY® compatible. Patented. cULus Listed.

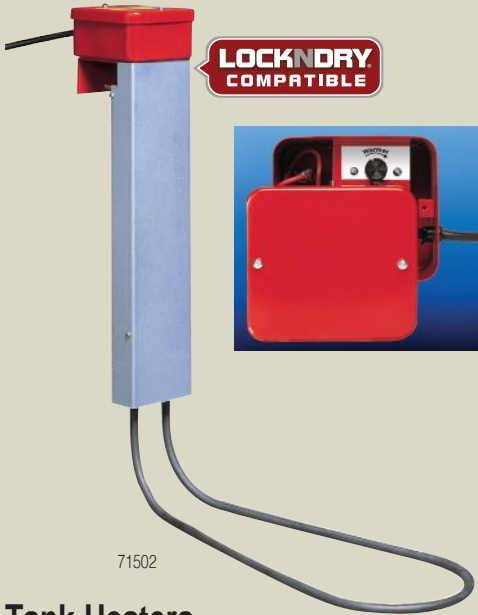

71502

Tank Heaters

71502 Tankside Heater - 1500 Watts, 120 Volts €

L 7" x W 20" x H 25" • 1 pk

Clamps to the side of a metal stock tank. The tankside heater comes with an adjustable and replaceable thermostat that allows the user to set the water temperature. This unit takes the place of a de-icer by maintaining the water temperature near a set point. Not for use in plastic tanks. Includes 6-foot cord. LOCKNDRY® compatible.

Electric Water Heater Base

Helps prevent water from freezing in temperatures as low as 10 degrees F. Designed for use with Little Giant® Double Wall Fountains (Item Nos. 9832, 9833, 9835, and 9838, sold separately, see page 34) and other all-metal containers. The heating element has been completely redesigned for improved safety and efficiency. The fully enclosed bottom adds another layer of protection. Perfect for unheated coops and barns; can be used outdoors in a dry, sheltered area. Made of heavy-duty, rust-resistant galvanized steel. Cord should be protected from animals and used with a Ground Fault Circuit Interrupter (GFCI) protected outlet. Unit will not draw electricity until temperature drops below freezing. Uses less than 1 amp per hour. 120V, 60 Hz, 110W, .92A. LOCKNDRY® compatible.

HB130 Electric Water Heater Base - 110 Watts €

L 16.25" x W 16.25" x H 3.67" • 1 pk

NEW! HB140 Heater Base CSA Certified - 110 Watts €

L 16.25" x W 16.25" x H 3.67" • 1 pk



HB130



HPW33

Poultry Waterer

Patented design provides your poultry with fresh water all winter long. Keeps water ice-free down to -5 degrees F in the winter, but can be used year round as well. Thermostatically controlled with optimized heater pad design for maximum heating efficiency to ensure ice-free water. Sturdy galvanized steel handle. Rounded top of water jug helps prevent chickens from roosting. 3-gallon capacity. 4-foot cord. 60 Hz. LOCKNDRY® compatible. cULus Listed.

One year warranty.

HPW33 Heated Poultry Fountain
100 Watts, 120 Volts €

L 13.62" x W 13.62" x H 16.75" • 4 pk

Heated Poultry Mat

Constructed of durable, weather-resistant plastic with welded seams for safety and longer life. Our mats are designed to be used for both adult birds and chicks. The low wattage and thermostat provides adequate heat without overheating the birds while also using less power. Our unique, patented design allows air flow completely around the heating element to eliminate hot spots common with other plastic mats. 6-foot anti-chew cord. LOCKNDRY® compatible. cULus Listed.

HPM-S Heated Poultry Mat - 33 Watts, 120 Volts €

L 19" x W 13" x H 1" • 6 pk



HPM-S



Heated Hoses

This cold weather hose is excellent for tasks requiring running water in below-freezing temperatures. Featuring a highly efficient internal heating extrusion, API's heated hose maximizes heat retention. The heating element extends all the way to both ends, eliminating frozen connection points. It features a high-quality 5/8" hose with standard brass garden hose fittings and is thermostatically controlled for energy-efficient operation. It can be run continuously or simply plugged in when needed. LOCKNDRY® compatible.

DH25 Deluxe Winterflo™
Heated Hose 180 Watt,
120 Volts, 25 feet €
L 300" x W 2" x H 2" • 3 pk

DH50 Deluxe Winterflo™
Heated Hose 360 Watt,
120 Volts, 50 feet €
L 600" x W 2" x H 2" • 3 pk



DH25

DH50

LOCKNDRY® Outdoor/Indoor Detachable Power Supply Cord

Secure water-resistant electrical connection. The revolutionary LOCKNDRY® outdoor/indoor detachable power supply cord provides a weather-resistant seal while keeping the connection firmly secured. The specially designed plug on the LOCKNDRY® cord fits any standard outlet, but when mated with a LOCKNDRY® compatible power cord, the large black nut pulls the plug tight against the gasket to form a water-resistant seal. The red nut then locks everything in place and prevents cord separation. The LOCKNDRY® is great as an all-purpose extension cord.

16 gauge, 13 Amp Rating, 25 feet. cULus Listed.

LD16-25 LOCKNDRY® Outdoor/Indoor Detachable 25' Power Supply Cord €

L 300" x W 1.75" x H 1.75" • 6 pk

Easy to display packaging!



LD16-25

ClickShield™ Cord Lock

The ClickShield™ Cord Lock is the fast and inexpensive way to weatherproof any power cord, while also eliminating irritating and dangerous disconnects. The durable all-weather plastic shield has a unique ratchet mechanism; when you hear the 'click' you know it's securely locked. The internal gasket assures a water-resistant electrical connection. The ClickShield™ is great for Christmas lights or other electrical holiday yard decor, power tools, or outdoor equipment of any kind. ClickShield™ is the essential outdoor electrical accessory.

28CSG ClickShield™
Cord Lock – Green €

L 4.625" x W 2.75" x H 2.125" • 12 pk

28CSK ClickShield™
Cord Lock – Black €

L 4.625" x W 2.75" x H 2.125" • 12 pk

28CSO ClickShield™
Cord Lock – Orange €

L 4.625" x W 2.75" x H 2.125" • 12 pk

Easy to display packaging!



28CSO

28CSK

28CSG



Heated Pet Beds

Made of durable faux suede with a fleece top. Our beds come with three separate foam layers that allow placement of the bed warmer for just the right amount of heat. Each bed is heated by included 12H Pet Bed Warmer. The warmer plugs into any standard 120 volt outlet but provides 24 volts to the heater for safety. 12 watts, 24 volts. 60 Hz. Includes 6' anti-chew cord. Patented. cULus Listed.

12PB-S Small Heated Pet Bed, Assorted Colors €

L 23" x W 23" x H 2.5" • 6 pk

12PB-M Medium Heated Pet Bed, Assorted Colors €

L 28" x W 28" x H 2.5" • 6 pk

12PB-L Large Heated Pet Bed, Assorted Colors €

L 28" x W 43" x H 2.5" • 6 pk

12PB-R Round Heated Pet Bed €

L 23" x W 23" x H 2.5" • 6 pk

6 PK Contains 2 of Each Color! ➔



12PB-R Round



Small



Large



98P-M Medium

Approved for indoor or outdoor use. Constructed of durable, weather-resistant plastic with welded seams for safety and longer life. A washable, fleece-like cover is also included. Our unique, patented design allows air flow completely around the heating element to eliminate hot spots common with other plastic mats. Our mats are designed to be used in dog houses, garages, kennels, or anywhere your pet needs added warmth. Includes 6-foot anti-chew cord. LOCKNDRY® compatible. Patented.

Heated Plastic Mats



98P-XS Extra Small

98P-XS Extra Small Plastic Heated Pet Mat
25 Watts, 120 Volts

L 12" x W 9" x H 1" • 12 pk

Extra small size is great for rabbit cages.

98P-S Small Plastic Heated Pet Mat
33 Watts, 120 Volts €

L 19" x W 13" x H 1" • 6 pk

cULus listed.

98P-M Medium Plastic Heated Pet Mat
57 Watts, 120 Volts €

L 24" x W 17" x H 1" • 6 pk

cULus listed.

98P-L Large Plastic Heated Pet Mat
75 Watts, 120 Volts €

L 28.75" x W 22.875" x H 1" • 6 pk

cULus listed.



Easy to display packaging!

Each pet mat includes a washable, fleece-like cover.



Pet Bed Warmer

Provides gentle heat and can be used with any pet bed that measures at least 12" x 15". A transformer plugs into any standard outlet and supplies a safe 24 volts to the heating element. Transformer plugs into 120 volt outlet. Includes 6-foot anti-chew cord. cULus listed.

12H Pet Bed Warmer

12 Watts, 24 Volts €

L 15" x W 12" x H 0.375" • 6 pk



12H



Heated Pet Bowls

SB50 Heated 1.25 Gallon Stainless Pet Bowl 50 Watts, 120 Volts

L 15.375" x W 15.375" x H 4.5" • 6 pk
Stainless steel, tip-proof pet bowl holds 1.25 gallons and is thermostatically controlled. The heating element is detachable for summer storage and dishwasher-safe cleaning. Can be nested with the cord coiled and secured to the bottom for a neat shelf appearance. 6-foot anti-chew cord. LOCKNDRY® compatible. cULus Listed.



SB50
1.25 Gallon



1B
1 Quart

1B Heated Plastic 1 Quart Pet Bowl 25 Watts, 120 Volts

L 9.75" x W 9.75" x H 4" • 6 pk
Thermostatically controlled for efficient operation and features a convenient non-tip design. 6-foot anti-chew cord. LOCKNDRY® compatible.

HPB5 Heated Plastic 5-Quart Pet Bowl 50 Watts, 120 Volts

L 12.375" x W 12.375" x H 5.25" • 6 pk
Thermostatically controlled for efficient operation. Made from a special, resilient plastic that can flex slightly and prevent cracking in freezing temperatures. The non-tip design prevents spills and messes. 6-foot cord with anti-chew protector. LOCKNDRY® compatible. cULus Listed. One year warranty.



LOCKNDRY
COMPATIBLE



HPB5
5 Quart

! On SB50, the heating element is removable for year-round use of the bowl, dishwasher safe cleaning.

Heated Waterers

90 Heated Stainless 1-Quart Pet Bowl With Cage Mount - 25 Watts, 120 Volts, 60 Hz

L 6.5" x W 7" x H 3.75" • 6 pk
Made of stainless steel for easy cleaning. Comes with a mounting ring for attachment to any cage. The bowl can also stand alone on a flat surface. 6-foot anti-chew cord. LOCKNDRY® compatible. cULus Listed.



90
1 Quart

Easy
to display
packaging!



Easy
to display
packaging!



HRB32
32 Oz

HRB32 Heated 32 Oz Rabbit Bottle 20 Watts, 120 Volts, 60 Hz

L 3.5" x W 4" x H 9.125" • 6 pk

This heated bottle keeps drinking water ice-free, even in sub-zero temperatures. Attaches easily to a cage. 12-15" anti-chew cord.

Bird Baths

API® offers a wide range of bird baths for our feathered friends in every season. API® bird baths will supply wild birds with fresh, open water throughout the winter while attracting them during the warm summer months, too!

Deck Mount Bird Baths



14B
Heated 14" Bird Bath

14B Heated 14" Bird Bath with EZ-Tilt™ Deck & Pole Mount, 70 Watts, 120 Volts 🇺🇸

L 14" x W 14" x H 4" • 6 pk

Thermostatically controlled and tested to -20 degrees F. 15-inch cord. LOCKNDRY® compatible. Patented. CSA Listed.



650
Heated 20" Bird Bath

650 Heated 20" Bird Bath with EZ-Tilt™ Deck Mount, 150 Watts, 120 Volts 🇺🇸

L 20" x W 20" x H 4" • 6 pk

Thermostatically controlled and tested to -20 degrees F. The unique patented EZ-Tilt™ Deck Mount is included and allows easy mounting to a wooden deck rail. 15-inch cord. LOCKNDRY® compatible. Patented. CSA Listed.



Bird Baths with Stands



400
12" Bird Bath



970
20" Bird Bath



400 Heated 12" Bird Bath With Stand 50 Watts, 120 Volts, 60 Hz

L 12" x W 12" x H 30" • 6 pk

Plastic, terra cotta-colored heated bird bath provides ice-free water all winter long. Thermostatically controlled and specifically designed to attract wild birds, a contoured rim fits the average bird's talon, a gradual slope encourages bathing, and a textured surface ensures a sure grip. The heating element containing all electrical parts simply snaps in place and may be removed during non-winter months so it can be used year-round. Includes 15-inch cord. LOCKNDRY® compatible. CSA Listed.

970 Heated 20" Bird Bath With Stand, 150 Watts, 120 Volts, 60 Hz

L 20" x W 20" x H 30" • 6 pk

Thermostatically controlled and tested to -20 degrees F. Includes 15-inch cord and 30" metal stand. LOCKNDRY® compatible. CSA Listed.

Decorative Bird Baths



600
20" Bird Bath



600 Heated 20" Bird Bath - 150 Watts, 120 Volts, 60 Hz

L 20" x W 20" x H 4" • 6 pk

Beige thermostatically controlled heated bird bath. Comes with hardware to mount to most posts, pedestals (stone, wood, or plastic) or deck railings. Includes 15-inch cord. LOCKNDRY® compatible. CSA Listed.

670 Heated 20" Bird Bath With Pedestal - 150 Watts, 120 Volts, 60 Hz

L 20" x W 20" x H 27.25" • 1 pk

Comes with a plastic pedestal. The cord can be routed through the pedestal and the base filled with sand or gravel for additional stability. Includes 15-inch cord. LOCKNDRY® compatible. CSA Listed.



670
20" Bird Bath



Bird Bath De-Icers

Bird Bath de-icers are a great way to maintain a fresh, open water supply for wild birds with nearly any unheated bird bath. With low-profile designs, API® bird bath de-icers keep feathered friends hydrated using the same dependable heating technology expected from our products.

300 Bird Bath De-Icer - 200 Watts, 120 Volts, 60 Hz

L 7.75" x W 2.75" x H 0.875" • 6 pk

Features a built-in thermostat for temperature control and over-temperature protection to keep your bird bath ice-free all winter long. A stainless-steel guard shields wildlife from contacting the heating element. Can be used in pottery, plastic, or concrete bird baths. Recommended for up to 15 gallons of water. Includes 15-inch anti-rub cord. LOCKNDRY® compatible. cULus Listed. CSA Listed.



300

BDT250 Bird Bath De-Icer With Aluminum Base

250 Watts, 120 Volts, 60 Hz

L 4.75" x W 4.75" x H 1.125" • 6 pk

Durable, non-stick coating, compact aluminum base in a low-profile design. Fins provide large surface area to make the unit run cooler while putting out the same amount of heat as conventional de-icers. Channels within the base promote water flow as the water is heated. Cooler running, non-stick coating, and flowing water all combine to reduce mineral buildup. Multiple thermostats allow efficient control while providing over-temperature protection. The BDT250 is safe to use in plastic bird baths and comes with a 10-foot anti-rub cord. Recommended for up to 15 gallons of water. LOCKNDRY® compatible. cULus Listed.



BDT250

Water Wigglers®



5WWG-W



7WW

4WW Standard Water Wiggler®

L 5" x W 5" x H 5" • 6 pk

Features a unique agitator action that creates continuous ripples that help prevent the spread of West Nile Virus by eliminating stagnant water in bird baths. Easy to install - just place and go! The moving water created by the Water Wiggler® will help attract birds to your bath. There is no wiring and no plumbing. It operates on two D-cell batteries (not included). This Water Wiggler® is completely silent. Patented.

5WWG-W Water Wiggler®

With Pottery Cover

L 5.675" x W 5.675" x H 5.5" • 6 pk

Features the same performance as the Standard Water Wiggler® enhanced by a ceramic cover. Patented. Operates on two D cell batteries (not included).

7WW Aurora Water Wiggler®

L 5.25" x W 5.25" x H 5.5" • 6 pk

Lights up at dusk and provides three hours of pleasing colors as the dome slowly shifts through the spectrum. A sensor on the underside of the Aurora Water Wiggler® turns the unit on at dusk. The lights will automatically shut off after three hours and come back on the following evening. It will continuously agitate the water to prevent mosquitoes from laying eggs even when the lights are off. Patented. Operates on two D cell batteries (not included).



4WW

8WW Solar Water Wiggler®

L 5.25" x W 5.25" x H 5.5" • 6 pk

Includes all of the great features of the Standard Water Wiggler® but it's powered by the sun. Just place it in your bird bath and it will operate unattended until you remove it. For best results, the Solar Water Wiggler® should be used in full sunlight. Patented. Rechargeable battery included.



8WW



Pond De-Icers

Maintaining open water during the winter in backyard ponds is critical to a healthy aquatic environment. API® heated pond products are designed to allow gases from decomposition to escape, allowing ponds to flourish.

P7521 Floating Pond De-Icer

1500 Watts, 120 Volts, 60 Hz

L 8.25" x W 8.25" x H 4" • 6 pk

Keeps a pond completely ice-free, providing fresh oxygen into your pond for healthy fish. Thermostatic control coupled with thermal feedback protects the unit from overheating, while positioning the thermostat above the heating element ensures safety in low-water conditions. The float is completely enclosed in a rugged, plastic housing and will not sink over time. Recommended for 100-300 gallons of water. Includes 15-foot anti-rub cord. LOCKNDRY® compatible. cULus Listed.

P7621 Floating Pond De-Icer

1000 Watts, 120 Volts, 60 Hz

L 8.25" x W 8.25" x H 4" • 6 pk

Same as the P7521 with 1000 watts, 120 volts. Recommended for 70-100 gallons of water. Includes 15-foot anti-rub cord. LOCKNDRY® compatible. cULus Listed.



P7521 & P7621



P15N



P15N Sinking Pond De-Icer

1500 Watts, 120 Volts, 60 Hz

L 14.25" x W 14.25" x H 6.25" • 6 pk

Operates at the bottom of your pond where it is less likely to be disturbed by fish. Keeping your pond open allows fresh oxygen into your pond during all seasons, keeping your fish healthy. Thermostatic control coupled with thermal feedback protects the unit from overheating, while positioning the thermostat above the heating element ensures safety in low-water conditions. Each unit comes complete with a galvanized wire guard to protect rubber and plastic ponds. Recommended for 100-300 gallons of water. Includes 15-foot anti-rub cord. LOCKNDRY® compatible. UL Listed. CSA Listed.



Pet & Small Animal Supplies

In 2003, Miller introduced the Pet Lodge® brand of pet products. Since then, Pet Lodge® has grown to over 160 top quality feeding, watering, containment, housing, bedding and clean-up products.

We are continually adding reliable and safe products that meet the needs of our valued customers.



Wire Pet Barrier

Helps keep pets safe in the rear of SUV's, minivans and wagons. The uniquely designed panels adjust vertically and horizontally offering a customized fit. Easy assembly with no tools required. Hardware and instructions included. Heavy-duty metal, black e-coated for corrosion resistance.

100434 Wire Pet Vehicle Barrier-Black
39.375" - 79" Wide, 32.5" - 52" tall • 1 pk



Easy to display packaging!

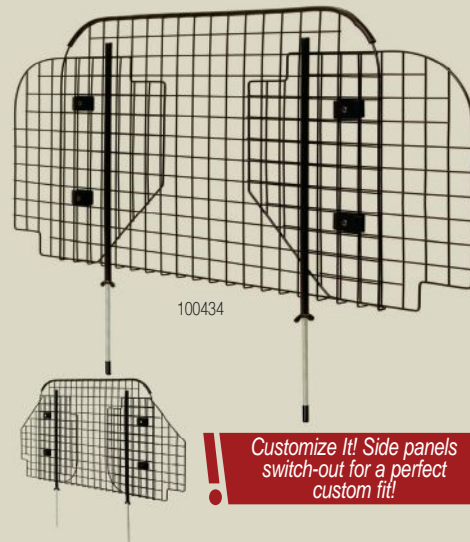

100434

Customize It! Side panels switch-out for a perfect custom fit!

Exercise Pens

Safely contains pet indoors and outdoors. Quickly folds flat for storage and transport. Attach two or more pens together for a larger play area. Available in five heights. Made out of heavy-duty metal, black e-coated for corrosion resistance.

ITEM	DESCRIPTION	SIZE	CASE PACK
100403	24" Exercise Pen-Black	L 58.4" x W 58.4" x H 24"	1 pk
100441	30" Exercise Pen-Black	L 58.4" x W 58.4" x H 30"	1 pk
100410	36" Exercise Pen-Black	L 58.4" x W 58.4" x H 36"	1 pk
153218	42" Exercise Pen-Black	L 58.4" x W 58.4" x H 42"	1 pk
100427	48" Exercise Pen-Black	L 58.4" x W 58.4" x H 48"	1 pk



Easy to display packaging!



Use for a variety of pets



Includes 8 ground stakes, 4 easy-to-use bolt snaps and plastic carrying handle





Double Door Wire Pet Crates

Perfect for home, training and travel. This multi-functional pet crate is designed with your pet's safety in mind. Secure latches won't jiggle loose when in downward locked position. Rounded corners on all panels help ensure safety for owner and pet. Popular suitcase style crate sets up in seconds and folds down for storage. Includes divider panel, removable easy-to-clean plastic tray and removable plastic carrying handle. Rubber feet at each corner. Available in 4 sizes in black. Black e-coated metal for corrosion resistance.

ITEM	DESCRIPTION	SIZE	CASE PACK
WCMED Medium Wire Double Door CrateL 30" x W 21" x H 24" 1 pk
WCLRG Large Wire Double Door CrateL 36" x W 24" x H 27" 1 pk
WCXLG X-Large Wire Double Door CrateL 42" x W 27" x H 30" 1 pk
WCGNT Giant Wire Double Door CrateL 48" x W 30" x H 33" 1 pk



WCGNT
up to 130 lbs.

Single Door Wire Pet Crate

ITEM	DESCRIPTION	SIZE	CASE PACK
WCXSM Extra Small Wire Single Door CrateL 19.5" x W 12.25" x H 15" 1 pk
WCSML Small Wire Single Door CrateL 24" x W 18" x H 21" 1 pk



WCXLG
up to 100 lbs.



WCLRG
up to 70 lbs.



WCSML
Single Door up to 30 lbs.



WCXSM
Single Door up to 10 lbs.



WCMED
up to 50 lbs.



Easy to display packaging!



150576
Large

Plastic Trays

ITEM	DESCRIPTION	SIZE	CASE PACK
179195 Extra Small Plastic Tray L 18.5" x W 11.75" x H 1.25" 1 pk
150552 Small Plastic Tray L 23" x W 17.25" x H 1.25" 1 pk
150569 Medium Plastic Tray L 28.75" x W 20" x H 1.25" 1 pk
150576 Large Plastic Tray L 34.5" x W 23" x H 1.25" 1 pk
150583 X-Large Plastic Tray L 40.5" x W 26" x H 1.25" 1 pk
150590 Giant Plastic Tray L 46.5" x W 29" x H 1.25" 1 pk



Double Door Plastic Pet Crates

Twice as nice! The Pet Lodge® Double Door Portable Plastic Pet Crates include a second door for added flexibility in use and transport. They feature updated styling and colors and are designed to meet the requirements of the International Air Transport Association (IATA). The easy-to-assemble design includes durable wire doors and vents are made of rugged polypropylene construction, which is strong enough to withstand the rigors of travel and regular use. They are available in 5 sizes.

ITEM	DESCRIPTION	SIZE	CASE PACK
157292	Small Double Door Plastic Crate	L 28" x W 20" x H 19"	3 pk
157308	Medium Double Door Plastic Crate	L 33" x W 22" x H 23"	3 pk
157315	Large Double Door Plastic Crate	L 37" x W 24" x H 26"	2 pk
157322	X-Large Double Door Plastic Crate	L 41" x W 27" x H 30"	2 pk
157339	Giant Double Door Plastic Crate	L 49" x W 32" x H 35"	1 pk



157292
up to 30 lbs.



157308
up to 50 lbs.



157315
up to 70 lbs.



157322
up to 100 lbs.

157339
up to 130 lbs.

Fleece Pet Beds

Ideal for use in crates, carriers and houses. Your pet will enjoy relaxing on the soft cushioned poly and cotton base bed. Quickly rolls up for storage. Machine washable. Available in six sizes and two colors.

Extra Small Pet Bed

L 18.25" x W 11.5" x H 2.75" • 12 pk

179225 XS 19" Fleece Bed Cream

Small Pet Beds

L 22.5" x W 17.4" x H 1.22" • 12 pk

152235 SM 23" Fleece Bed Cream

160742 SM 23" Fleece Bed Chocolate

Medium Pet Beds

L 29" x W 21.25" x H 1.22" • 12 pk

152242 MED 29" Fleece Bed Cream

160759 MED 29" Fleece Bed Chocolate

Large Pet Beds

L 35" x W 22.5" x H 1.52" • 12 pk

152259 LG 35" Fleece Bed Cream

160766 LG 35" Fleece Bed Chocolate

X-Large Pet Beds

L 41" x W 25.5" x H 3" • 6 pk

152266 XL 41" Fleece Bed Cream

160773 XL 41" Fleece Bed Chocolate

Giant Pet Beds

L 47" x W 29.125" x H 3" • 6 pk

152273 GNT 47" Fleece Bed Cream

160780 GNT 47" Fleece Bed Chocolate





Chow Hound Dog Feeders

Chow Hound automatic dog feeders are manufactured from tough galvanized steel for durability. Specially angled chute provides a steady food flow on demand. The magnetized door stays shut until your dog nudges it open. Food stays fresh, dry and free from unwanted pests. Top opens for easy filling. Fully assembled.

ITEM	DESCRIPTION	SIZE	CASE PACK
CH12	12-lb. Chow Hound	L 8" x W 9" x H 19.25"	1 pk
CH25	25-lb. Chow Hound	L 11" x W 12" x H 22.625"	1 pk
CH50	50-lb. Chow Hound	L 12" x W 16.25" x H 28.25"	1 pk

Easy to display packaging!



DuraFlex Feeders

ITEM	DESCRIPTION	SIZE	CASE PACK	COLORS AVAILABLE
P5	5 Quart Plastic Utility Pan	L 11.5" x W 11.5" x H 4"	24 pk	Black, Blue, Green, Pink, Purple, Red, Yellow
FP10BLACK	10 Quart Plastic Feed Pan	L 18.5" x W 18.5" x H 5.25"	12 pk	Black
HP1	2 Quart Rubber Feed Pan	L 8.5" x W 8.5" x H 4"	6 pk	
HP2	4 Quart Rubber Feed Pan	L 11" x W 11" x H 4"	6 pk	
HP8	8 Quart Rubber Feed Pan	L 14.5" x W 14.5" x H 4.5"	12 pk	





Crock Bowls

Crock-style dishes feature chew-resistant walls and rims. Dishwasher safe.

ITEM	DESCRIPTION	SIZE	CASE PACK
CR3GRANITE	20 Oz Medium Crock Bowl	L 5.75" x W 5.75" x H 2.25"	12 pk
CR4GRANITE	48 Oz Large Crock Bowl	L 7.79" x W 7.79" x H 2.7"	12 pk
CR5GRANITE	96 Oz Jumbo Crock Bowl	L 9.5" x W 9.5" x H 3.5"	12 pk



CR3GRANITE
20 Oz



CR5GRANITE
96 Oz

CR4GRANITE
48 Oz



Ever Full Dog Waterers

Ever Full is the automatic dog watering system that provides a continuous flow of the freshest water for your pet. Attach the 3/4" hose to your garden hose, turn on the tap, and the bowl fills to the perfect drinking level. The automatic float controls the water level so there's no spillage or overflow. Bowl is automatically replenished every time your dog drinks. Available in plastic or galvanized. Comes with hose and hose adaptor.

PW5 5 Quart Plastic Ever Full Bowl
L 12" x W 11.5" x H 4.5" • 1 pk
Available in blue.

EF3 3 Gallon Plastic Ever Full Bowl
L 17.25" x W 17" x H 4.5" • 1 pk
Available in blue.

PW13 13 Quart Galvanized Steel Ever Full Bowl
L 17" x W 16.5" x H 3.625" • 1 pk

TAP1 Tap Adapter
L 1.25" x W 1.25" x H 3.5" • 12 pk
Save time, worry, and work with this stainless steel self-watering device. Attach to any outdoor spigot, turn on the faucet and your dog will have a tongue-triggered fresh supply of water.



Easy to display packaging!



PW13
13 Quart



PW5
5 Quart



EF3
3 Gallon



Easy to display packaging!

TAP1





Chow & Water Towers

Automatically dispenses a continuous supply of food or water into a sturdy plastic base.

Deluxe Towers

Updating styling features a solid one-piece base design. Easy-to-remove bottle makes refilling simple. Can be used both indoors and outdoors. Available in 3 sizes.

157759 3 Quart Water Tower Deluxe ✨
L 10.875" x W 6.125" x H 10.75" • 2 pk

157766 3 Lb Chow Tower Deluxe ✨
L 10.875" x W 6.125" x H 11" • 2 pk

157773 8 Quart Water Tower Deluxe ✨
L 14.5" x W 8.125" x H 14.5" • 2 pk

157780 8 Lb Chow Tower Deluxe ✨
L 14.5" x W 8.125" x H 14.75" • 2 pk

157797 16 Quart Water Tower Deluxe ✨
L 18.5" x W 10.125" x H 17.75" • 2 pk

157803 16 Lb Chow Tower Deluxe ✨
L 18.5" x W 10.125" x H 18" • 2 pk



157797
16 Quart

157803
16 lbs.



157759
3 Quart

157766
3 lbs.



PT128
128 Oz



171694

PT128 128 Oz Pet Treat Jar ✨

L 5.75" x W 5.75" x H 11" • 10 pk

This airtight container keeps treats fresh.

171694 7" Food Bag Clip ✨

L 5.25" x W 2.75" x H 8.25" • 12 pk

Keeps food fresh and prevents spills. Features extra wide mouth for large bags of food and soft non-slip finger grips.



157773
8 Quart

157780
8 lbs.



Travel-Pal Waterer

Travel-Pal is the dog watering system that's rugged enough for outdoor use or travel, but attractive enough for indoor use. The translucent polyethylene jug allows you to monitor the water level. The molded handle makes it easy to carry.

TP3 3 Gallon Travel-Pal

L 13" x W 18.25" x H 14.75" • 2 pk



Improved cap design. O-ring fits securely in a machined radial groove.

TP3
3 Gallon



Kennel Care

With the Kennel Crocks, dogs receive necessary nourishment while kennels stay clean! Off-the-floor design and secure attachments prevent spills. Ideal for pet carriers, holding pens, display cages and kennels. Quick-turn screw and bracket design locks crock in place.

Available in granite color.

KC20 20 Oz Kennel Crock

L 6.5" x W 5" x H 3.75" • 12 pk

KC40 40 Oz Kennel Crock

L 7.5" x W 6" x H 4.875" • 12 pk

Kennel Crocks can easily be removed for cleaning.

Dishwasher safe.



Easy to display packaging!

- Lock-in-place design prevents spills
- Twist and release lock detaches bowl from base for easy cleaning
- Fits all wire cages
- Use on vertical or horizontal wire
- Dishwasher safe

KC20
20 Oz



Water Bottles

ND44 44 Oz No-Drip Water Bottle

L 4.5" x W 7" x H 12.5" • 18 pk
Features a no-drip tube that is perfect for travel. Hinged top flips up for easy cleaning and filling. Mounts easily to most crates and pens.

WM32 32 Oz Wide Mouth Water Bottle

L 4" x W 5" x H 12" • 12 pk
Designed for medium to large breed dogs to use in carriers, holding pens and crates. Mounts easily with included quick release spring.



ND44
44 Ozs
Patented Design



WM32
32 Ozs

Travel Waterers

The WaterBoy® and ThirstyDog® make traveling with your dog a cinch.

TWB3 3 Quart WaterBoy® Travel Water Bowl

L 12" x W 8" x H 3" • 6 pk
Provides fresh water without spilling in your vehicle. It is great for use in RV's, SUV's, trucks, cars and boats. It allows you to take fresh water anywhere.

TD20 20 Oz ThirstyDog® Pet Sport Bottle

L 7.5" x W 3.125" x H 3" • 6 pk
Flip down water bottle for dogs of all sizes. Simply unplug the bottle and the bowl fills - no squeezing required. Designed with wide mouth to allow the insertion of ice cubes for hot days. Comes with adjustable shoulder strap which can be carried on belt or wristband while walking or hiking.



TWB3
3 Quart



TD20
20 Oz

Easy Scoop Pooper Scoopers

Easy Scoops feature a lightweight polycarbonate basket that's tough, durable and built to last. Specially angled tines make scooping easy. Our telescoping model brings hi-tech engineering to the scooping business. The lightweight aluminum handle adjusts from 22" to 42" for efficient merchandising.

ES1 Standard Scoop with Hardwood Handle

L 5" x W 7.25" x H 42" • 6 pk

ES2 Premium Scoop with Telescoping Handle

L 5" x W 7.25" x H 22"min/42"max • 6 pk



ES2
Adjusts
from 42"
to 22"

Patented
Design

ES1

ES2

Patented
Design



Plastic Bottom Small Animal & Rabbit Homes

Deep plastic tray is ideal for in-home use by helping to contain bedding and litter. Easy to clean. Available in 3 sizes.

ITEM	DESCRIPTION	SIZE	CASE PACK
15093424.5" Green Plastic Bottom Rabbit CageL 24.5" x W 14" x H 16.5" 1 pk
15094131" Purple Plastic Bottom Rabbit CageL 31" x W 18.5" x H 16" 1 pk
15095840" Blue Plastic Bottom Rabbit CageL 40" x W 19" x H 21" 1 pk



Pop-Up Small Animal & Rabbit Homes

This updated design features rounded corners and evenly spaced wire for hanging feeders and waterers. Available in 3 sizes. Black e-coated wire.

ITEM	DESCRIPTION	SIZE	CASE PACK
15090325" Wire Pop-Up Rabbit CageL 25" x W 16" x H 19" 1 pk
15091030" Wire Pop-Up Rabbit CageL 30" x W 17" x H 20" 1 pk
15092737" Wire Pop-Up Rabbit CageL 37" x W 18" x H 21" 1 pk

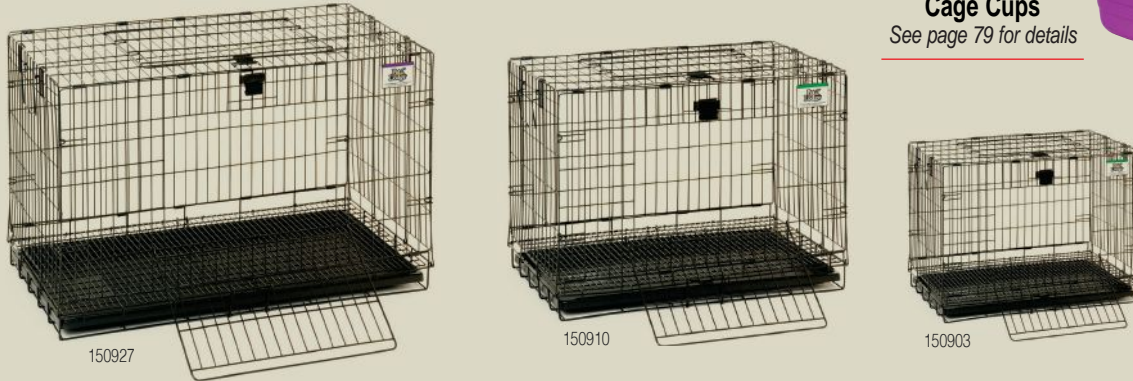

Cage Cups
See page 79 for details

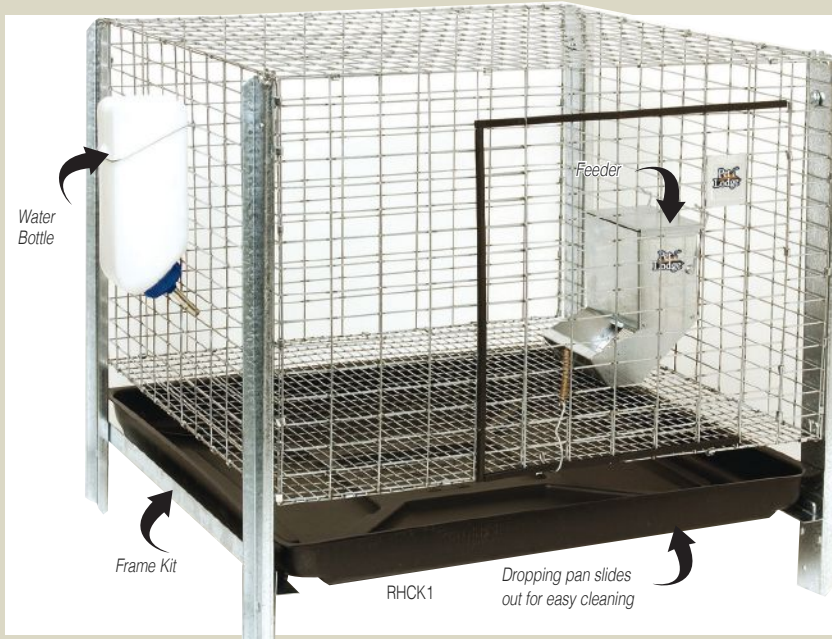

Rabbit Hutch Kit

This easy-to-assemble kit includes everything needed for rabbit raising—all in one package! Includes 24" x 24" x 16" hutch, plastic dropping pan, frame kit, 5" sifter feeder with lid, 32 oz. water bottle, cage clips and wire clip pliers

RHCK1 Rabbit Hutch Complete Kit
L 24" x W 24" x H 23" • 1 pk



Rabbit Hutches

Hutch Only Kits These easy-assembly hutches are constructed with rust-resistant, easy-to-clean galvanized wire mesh. Doors are surrounded by protective vinyl guards and feature spring tension door latches. Wire mesh bottom is 1" x 1/2" and sides are 2" x 1". Includes wire cage clips. Wire clip pliers are sold separately.

ITEM	DESCRIPTION	SIZE	CASE PACK
AH2424	24" x 24" Hutch	L 24" x W 24" x H 16"	1 pk
AH3030	30" x 30" Hutch	L 30" x W 30" x H 16"	1 pk
AH3036	30" x 36" Hutch	L 30" x W 36" x H 16"	1 pk

Hutches can be stacked. See other accessories needed for stacking below.

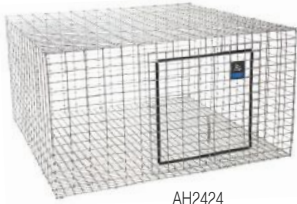

AH2424

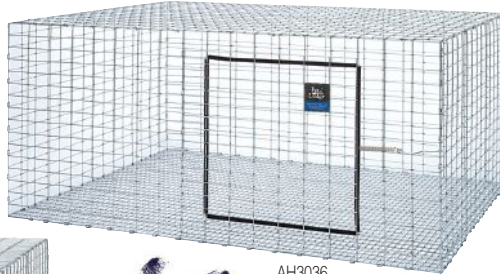

AH3036

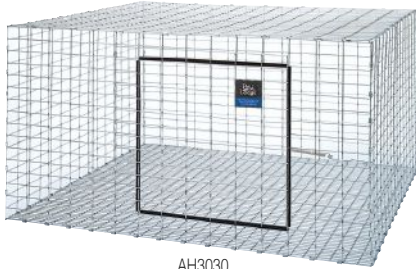

AH3030

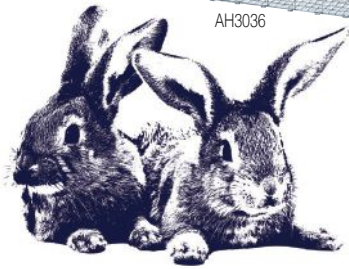

Easy to display packaging!

Dropping Pans

Made from heavy-duty galvanized steel with riveted corners and hemmed edges or plastic. Pans pull out for easy cleaning. Fully assembled.

ADP2424 24" x 24" Galvanized Dropping Pan for AH2424

L 24" x W 24" x H 2.75" • 1 pk

ADP3030 30" x 30" Galvanized Dropping Pan for AH3030

L 30" x W 30" x H 2.75" • 1 pk

ADP3036 30" x 36" Galvanized Dropping Pan for AH3036

L 30" x W 36" x H 2.75" • 1 pk

PDP2424 24" x 24" Plastic Dropping Pan

L 24" x W 24" x H 2" • 6 pk

One-piece seamless construction makes cleaning a snap. This all-purpose pan can be used for rabbit hutches, pet homes, cat litter tray, feed tray, or oil drip pan.



Easy to display packaging!

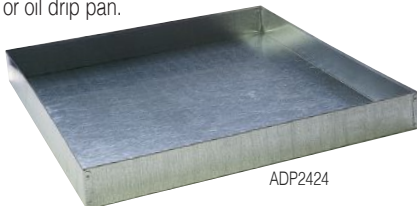

ADP2424



PDP2424

Urine Guard Kits

Galvanized guards help prevent urine from spraying out of the back and side of hutch. Attaches easily to wire mesh with pre-formed tabs.

AUG2424 For AH2424 Hutch
L 24.5" x W 4.5" x H 1.75" • 1 pk

AUG3030 For AH3030 Hutch
L 30.5" x W 4.5" x H 1.75" • 1 pk

AUG3036 For AH3036 Hutch
L 36.5" x W 4.5" x H 1.75" • 1 pk



AUG2424

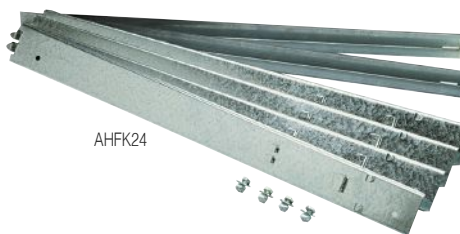

AHFK24

Frame Kits

Designed to suspend the hutch over the dropping pan for easier cleaning. Conserve space by stacking hutches four high when bolting frame kits together.

AHFK24 24" Frame Kit for AH2424

L 24.5" x W 2.5" x H 3" • 1 pk

AHFK30 30" Frame Kit for AH3030, AH3036

L 30.5" x W 2.5" x H 3" • 1 pk



153171



171540

See page 80 for SSW3 Salt Spool

Hay Racks

153171 Hay Rack

L 8.25" x W 3.25" x H 7.5" • 12 pk
Keeps hay clean while eliminating food waste. Built-in mineral spool holder. Fits most wire cages.

171540 Plastic Hay Rack

L 5.5" x W 4.5" x H 11" • 12 pk
Keeps food clean and eliminates wasted food. Fits most wire cages. No tools required for assembly.

Tools & Accessories

ACP2 Wire Clip Pliers

L 2" x W 0.5" x H 7.5" • 12 pk

Use to assemble hutches, pet homes and traps.

ACC1 1 lb Bag Wire Cage Clips

L 6" x W 1" x H 8.5" • 12 pk

Use to assemble wire panels for rabbit hutches and pet homes. Great for other uses. One package assembles 3-4 average size units.

ACC120 20 lb Box Wire Cage Clips

L 8.25" x W 10.75" x H 4.75" • 1 pk

AN1 Small Animal Nest

L 10" x W 18" x H 9.5" • 1 pk

Provides comfort and security for small animals. Nest is constructed from galvanized steel and includes removable wood floor.

171687 Hide-Away Castle

L 4.75" x W 4.75" x H 5.5" • 16 pk

Perfect for small pocket pets. Transparent jar allows easy viewing.

171649 Nesting Cotton

L 6.25" x W 2" x H 11.3" • 12 pk

Contains 100% top-grade short cotton fibers that are sanitized for pet's health. Conveniently packaged in resealable bag.

171663 Odor Eliminator

L 4.2" x W 1" x H 5.5" • 12 pk

Non-toxic refined carbon pellets and zeolite that absorb and neutralize molecule odors. Lasts up to 3 months. Attaches to outside of cages.



ACP2



AN1



171663



ACC1



171649



171687



AF7ML
7" Size



AF7S
7" Size



AF7SL
7" Size

Small Animal Feeder w/Metal Bottom & Lid

Independent wire hooks secure feeder to the hutch.

AF3ML 3" Feeder with Metal Bottom and Lid
L 5.5" x W 3.125" x H 7.125" • 12 pk

AF5ML 5" Feeder with Metal Bottom and Lid
L 5.5" x W 5.125" x H 7.125" • 12 pk

AF7ML 7" Feeder with Metal Bottom and Lid
L 5.5" x W 7.125" x H 7.125" • 12 pk



AF5ML
5" Size



AF3ML
3" Size

Small Animal Feeder w/Sifter Bottom

Independent wire hooks secure feeder to the hutch.

AF3S 3" Feeder with Sifter Bottom
L 5.5" x W 3.125" x H 7.125" • 12 pk

AF5S 5" Feeder with Sifter Bottom
L 5.5" x W 5.125" x H 7.125" • 12 pk

AF7S 7" Feeder with Sifter Bottom
L 5.5" x W 7.125" x H 7.125" • 12 pk



AF5S
5" Size



AF3S
3" Size

Small Animal Feeder w/Sifter Bottom & Lid

Independent wire hooks secure feeder to the hutch.

AF3SL 3" Feeder with Sifter Bottom and Lid
L 5.5" x W 3.125" x H 7.125" • 12 pk

AF5SL 5" Feeder with Sifter Bottom and Lid
L 5.5" x W 5.125" x H 7.125" • 12 pk

AF7SL 7" Feeder with Sifter Bottom and Lid
L 5.5" x W 7.125" x H 7.125" • 12 pk



AF5SL
5" Size



AF3SL
3" Size

Plastic Cage Cups

Polyethylene cups feature built-in hooks to clip onto the side of any type of wire animal cage. Available in: ■■■■

ITEM	DESCRIPTION	SIZE	CASE PACK
ACU1	1/2 Pint Plastic Cage Cup	L 5.29" x W 2.98" x H 1.78"	12 pk
ACU2	1 Pint Plastic Cage Cup	L 6.68" x W 3.65" x H 2.1"	12 pk
ACU4	1 Quart Plastic Cage Cup	L 8.9" x W 4.48" x H 2.4"	12 pk

ACU7
1/2 Pint



ACU6
1 Pint



ACU2
1 Pint



ACU1
1/2 Pint



ACU5
1 Quart



ACU4
1 Quart

Galvanized Cage Cups

Clips inside of cage for feeding & watering. Made of galvanized steel

ITEM	DESCRIPTION	SIZE	CASE PACK
ACU7	1/2 Pint Galvanized Cage Cup	L 4.56" x W 3.18" x H 1.56"	12 pk
ACU6	1 Pint Galvanized Cage Cup	L 6.12" x W 4.12" x H 1.93"	12 pk
ACU5	1 Quart Galvanized Cage Cup	L 8.75" x W 5.5" x H 2.25"	12 pk

ACU5
1 Quart





171656

Critter Nibblers

Wood chewing is essential for small animals to help trim and clean their teeth. 100% natural wood grown, processed and produced in the USA which contains no pollutants, insecticides, dyes or artificial flavors.

171656 Critter Nibblers ✪
L 3.625" x W 1.25" x H 6.25" • 12 pk

Easy to display packaging!

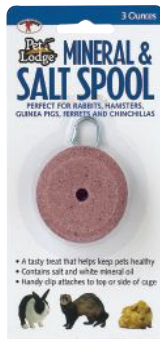

SSH2



SSW3



SSWHITE



SSH1

Salt Spools

A tasty treat for rabbits and small animals. Provides trace minerals essential for good animal health.

SSH2 Salt Spool and Hanger ✪
L 3.5" x W 1" x H 7" • 12 pk

SSH1 Salt Spool Hanger ✪
L 1.5" x W 0.25" x H 2.75" • 1 pk

SSW3 Mineral Spool Bulk ✪
L 2" x W 2" x H 1" • 24 pk

SSWHITE Salt Spool Bulk ✪
L 2" x W 2" x H 1" • 24 pk

Crocks

HBC1 High Bottom Cage Crock
L 4" x W 2.75" x H 4" • 24 pk

Specially designed for small animal homes with high bottoms.

SSC10 10 Oz Stainless Steel Crock
L 4" x W 4" x H 9" • 12 pk

Simple twist on, twist off removable design for easy removal and cleaning. Attaches to horizontal or vertical wire.



HBC1
Patented Design



SSC10
10 Oz
Patented Design

Quick-Lock Crocks

Attaches to horizontal or vertical wire. Quick-turn screw and bracket design locks crock in place. Crock can easily be removed for cleaning. Dishwasher safe. Available in granite color.

QLC10 10 Oz Quick-Lock Crock
L 6" x W 3.875" x H 3.75" • 12 pk

QLC20 20 Oz Quick-Lock Crock
L 6.5" x W 5" x H 3.75" • 12 pk



Easy to display packaging!



QLC20
20 Oz



Easy to display packaging!



FF36
8 Oz

Feeders

FF36 8 Oz Clear Plastic Food Funnel
L 3.625" x W 2.5" x H 6.625" • 12 pk

This off-the-floor feeder keeps food free from contamination by animal waste. Adjustable hanger attaches to plastic or glass aquarium or wire cage.

171588 Reversible Feeder & Waterer ✪
L 5.25" x W 9.5" x H 8.2" • 12 pk

Designed with a reversible base that allows you to go from feeder to waterer with a simple flip of the base. Ideal for hutches and outdoor playpens. Capacity of 48 Ozs liquid or 2 lbs of dry food.



171588
48 Ozs Liquid/
2 Lbs Dry
Patent Pending





FTB32
32 Oz

Flip Top Water Bottle

Hinged top flips up for easy cleaning and filling.

FTB32 32 Oz Flip Top Water Bottle

L 4.75" x W 3.5" x H 11.75" • 12 pk

Bottle Brush

Two brushes in one! The larger brush has an extra long handle to clean all sizes of bottles. The smaller, tapered-head brush is great for cleaning thinner tubes, spouts and spigots. Also works well on critter tubes and modular cages.

BBRUSH Bottle Brush

L 18" x W 4" x H 1.5" • 12 pk



Bunny Bottle

Large capacity water bottle features extra-wide mouth for easy filling.

BB64 64 Oz Bunny Bottle

L 5.25" x W 5.5" x H 10" • 6 pk



BB64
64 Oz

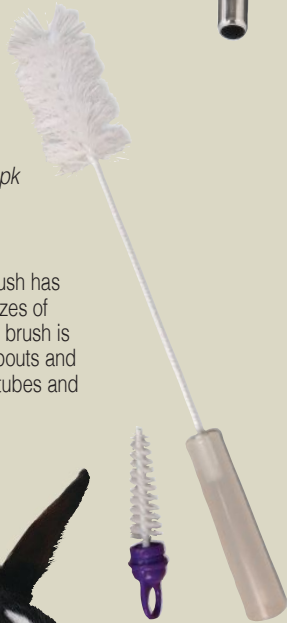

BBRUSH

Soda Bottle Converter

Converts most plastic soda pop bottles into a handy watering device for small animals. Simply screw in bottle and attach to cage with hanger.

EFF1 Earth Friendly Fountain

L 1.25" x W 5.5" x H 7" • 36 pk



EFF1



Earth Friendly Fountain

Easy to display packaging!

Galvanized bottle guards protect water bottles from animal chewing. Includes quick release spring bottle holder.

Bottle Guards

BG8 Bottle Guard fits 8 Oz Clear Plastic Water Bottle

L 2.5" x W 2.25" x H 7.25" • 12 pk

BG16 Bottle Guard fits 16 Oz Clear Plastic Water Bottle

L 3" x W 2.75" x H 8.75" • 12 pk



BG16



BG8



Weather-Tuff Water Bottles

Weather-Tuff water bottles are constructed from strong, ultraviolet-resistant polyethylene. These bottles work great outdoors. Stainless steel ballpoint tube keeps water clean and cage dry.

AW8 8 Oz Weather-Tuff Water Bottle
L 3" x W 2.25" x H 6.75" • 12 pk

AW16 16 Oz Weather-Tuff Water Bottle
L 3.5" x W 2.75" x H 7.5" • 12 pk

AW32 32 Oz Weather-Tuff Water Bottle
L 3.875" x W 3.25" x H 9.75" • 12 pk



Opaque Plastic Water Bottles

These water bottles are constructed from strong, opaque plastic with colorful graphics. Features stainless steel ballpoint tube and no-leak seal design which keeps water clean and cage dry.

OPB8 8 Oz Opaque Plastic Water Bottle ✨
L 3.25" x W 2" x H 8.25" • 12 pk

OPB16 16 Oz Opaque Plastic Water Bottle ✨
L 3.5" x W 2.5" x H 9.5" • 12 pk

OPB32 32 Oz Opaque Plastic Water Bottle ✨
L 4.5" x W 3" x H 11.5" • 12 pk



Clear Plastic Water Bottles

Clear plastic makes it easy to view water level. Features stainless steel ballpoint tube and no-leak seal design which keeps water clean and cage dry.

CPB8 8 Oz Clear Plastic Water Bottle ✨
L 3.25" x W 2" x H 8.25" • 12 pk

CPB16 16 Oz Clear Plastic Water Bottle ✨
L 3.5" x W 2.5" x H 9.5" • 12 pk

CPB32 32 Oz Clear Plastic Water Bottle ✨
L 4.25" x W 3" x H 11.5" • 12 pk



171601 Oral Syringe & Medicine Dropper
L 4" x W 1" x H 8.25" • 12 pk
Includes 10 ml syringe and 3 ml dropper. For administering food and medicine to small animals.

171618 Pill Popper
L 4" x W 1" x H 8.25" • 12 pk
For easy administration of pills to your pet. Features flexible, soft and safe tip for various pill sizes. Can be used to administer pills with or without liquid.



171670 Patented Design

171670 Medicine Saver ✨
L 3.625" x W 1" x H 6.25" • 12 pk
Helps to get every drop out of small animal medicine bottles. Includes 1 small and 1 medium self sealing adapter with 10 ml syringe.



171571 Small Pet Brush
L 5.5" x W 2" x H 6.5" • 18 pk
Designed with soft bristles that help small animals' coats stay clean and healthy.



REPLACEMENT PARTS

ITEM NUMBER	UPC	PRODUCT DESCRIPTION
Beekeeping Items		
LIDMTLS	084369179874	Metal Lid Small
LIDMTLL	084369179881	Metal Lid Large
LIDPL	084369179867	Plastic Lid Flip Top
HF9BLACK Plastic Hookover Goat Trough		
168755	084369168755	Goat Trough Grate (metal grate that fits on the top of the goat trough)
Plastic Fence Feeder		
FF16KIT	084369001687	Hardware Kit for FF16
FF20KIT	084369002066	2 Brackets, 4 Hex Nuts, 4 - 1" Screws
PF25KIT	084369110013	Parts Kit For PF25 Foal Feeder
HP750 Rubber Feeder Tub		
DF7	084369995146	Eyelet For HP750
DF9	084369995153	Eyelet Holder For HP750
Float Valves <i>See Figure 1 on page 85</i>		
T804	084369096140	L Bracket Plated
T806	084369806008	1/4 X 20 X 2 Thumb Screw
T805	A 084369805001	Mounting Bracket
T809AS	D 084369152051	Anti-Siphon Float For TM825AS & TM830AS
T809KIT	E 084369808125	For TM825 & TM830 - Float, Dart, Rubber Valve Seat
T811AS	F 084369811002	Anti-Siphon Valve Stem Housing
T810AS	G 084369810005	Anti-Siphon Valve Stem
T812AS	084369812009	Anti-Siphon Orifice
T814ASKIT	084369008143	1 Anti-Siphon Valve Stem Housing, 1 Anti-Siphon Valve Stem, 1 Plastic Orifice, 1 Hose Washer, 1 Valve Seat
T825KIT	084369995252	Trough-O-Matic Kit™
T825TKIT	084369995269	Parts Kit for TM825T & TM830T
T826	084369826006	Valve Seat
T826AS	084369826105	3/8" Neoprene Valve Seat
T828	084369828000	Washer for Trough-O-Matic™
T832P	084369831116	Orifice Insert for Trough-O-Matic
TOMASKIT	084369153249	Anti Siphon Repair Kit: 1 Float Assembly, 1 Anti-Siphon Valve Stem, 1 Plastic Orifice Insert, 1 Valve Seat, 1 Hose Washer, 1 - 2" Cotter Pin, 1 - 1" Cotter Pin
TOMKIT	084369153232	Trough-O-Matic Repair Kit: 4 Valve Seats, 4 Plastic Darts, 4 Washers, 4 Orifice Inserts, 4 - 2" Cotter Pins
77 Push Paddle Waterer <i>See Figure 2 on page 85</i>		
7705PK	A 084369152006	77 Pack: Valve Complete, Bagged & UPC
7706	084369770606	Nylon Retainer Nut
7707	084369770705	Valve Retainer Washer
7711PK	B 084369152013	77 Pack: Paddle Assembly, Bagged & UPC
7716PK	C 084369152020	77 Pack: Mounting Bracket, Bagged & UPC
7717	084369771702	Nylon Pipe Plug
7718KIT	D,E 084369152037	77 Kit-Valve Retaining
7719KIT	F,G,H 084369152044	77 Kit-Paddle Mounting
88SW & 88ESW Stock Waterers <i>See Figure 3 on page 85</i>		
STKIT	084369154321	Stock Tank Drain Plug Kit
SW8	084369800006	Rubber Grommet
SW9	084369100090	Bracket - Plated
SW10	084369101004	Fiber Washer
SSW11	084369111003	90 Duro Neoprene
SW14	084369140003	1/2" Flanged Lock Nut
SW19	084369190008	Plug
SW20	084369121019	Valve
SW23	084369230001	Float Only
SW24KIT	084369154574	Valve Assembly Kit

ITEM NUMBER	UPC	PRODUCT DESCRIPTION
88SW & 88ESW Stock Waterers <i>(Continued)</i>		
SW25CKIT	084369096133	Float Assembly Complete
88SWKIT		Bracket Kit for 88SW
ST40, 100, 150, 75, ST15 Stock Tanks		
STKIT	084369154321	Stock Tank Drain Plug Kit
Ever Full Dog Waterer		
PW1303	084369105095	Shield for PW13
PW503	084369105033	Shield for PW5
4WW Water Wiggler®		
5NC	022102051131	Natural Pottery Top for Water Wiggler®
FW16 DuraMate Automatic Waterer		
FW1602GREEN	084369159722	Float Cover
FW1603	084369001557	Bracket
FW1604	084369995238	Plastic Plug for Side of Waterer
FW1608	084369001724	Hose Adapter
FW1609	084369001762	Soft Plug for Bottom of Waterer
FW16KIT	084369001687	FW16 Kit: 2 Brackets, 1 Plug, 6 - 5/8" Screws, 4 Hex Nuts, 4 - 1" Screws, 1 Adapter, 1 Grommet Bumper, 1 Hose Washer
FW1630KIT	084369161770	Hose Accessory - FW16
160179	084369160179	Metal Cover for FW16 Automatic Waterer
168830 Hay Grazer		
168908	084369168908	Grazer Spring, Latch, Clip
168816	084369168816	Basic Goat & Sheep Feeder Replacement Liner
169516 Sprayer Boom		
169530	084369169530	Spray Boom Hose
169547	084369169547	Spray Boom Nozzle
CP8 Calf Pail		
CP8KIT	084369801140	Kit: 2 Brkts, 1 Mounting Plate, 4 - 3/8" Bolts, 1 Nipple, 1 Valve Assembly
CP804	084369008839	Calf Pail Nipple
CP804PK	084369008815	1 Pk CP804 Nipple in Bag w/ UPC
CP805CPK	084369008822	1 Pk Plastic Valve in Bag w/ UPC
CP806	084369096126	Neoprene Gasket
PDF1, DP1, DP2 & MDF2 DuraForks		
DP101RED	084369096584	Replacement Fork Head
DP201GREEN	084369154598	Replacement Fork Head
DP201RED	084369096492	Replacement Fork Head
PDF102	084369001021	PDF1 Wood Handle
PDF103BERRYBLUE	084369158992	Replacement Fork Head
PDF103BLACK	084369001038	Replacement Fork Head
PDF103BLUE	084369001045	Replacement Fork Head
PDF103BURGUNDY	084369001052	Replacement Fork Head
PDF103GREEN	084369001069	Replacement Fork Head
PDF103HOTPINK	084369158763	Replacement Fork Head
PDF103LIMEGREEN	084369158985	Replacement Fork Head
PDF103ORANGE	084369178945	Replacement Fork Head
PDF103PURPLE	084369001083	Replacement Fork Head
PDF103RED	084369000079	Replacement Fork Head
PDF103TEAL	084369001076	Replacement Fork Head
PDF1KIT	084369100007	Kit: 1 Screw, 1 Nut
MDF201	084369201001	MDF2 Fork Head Replacement

(Replacement Parts continued on next page)



REPLACEMENT PARTS

Replacement Parts

ITEM NUMBER UPC PRODUCT DESCRIPTION

CA500 Muck Cart		
CA500AXLE	084369155038	Muck Cart Axle
CA500HOOP	084369155069	Muck Cart Hoop
CA500KIT	084369155021	Hardware Kit for Muck Cart
CA500KS	084369155045	Muck Cart Kickstand
CA500TIRE	084369155052	Muck Cart Tire Assembly
CA500TUBE	084369155076	Muck Cart Tire Tube

Galvanized Hanging Poultry Feeders

912301	084369091466	Wire Locks for Hanging Feeders
912302	084369091480	Push On Clips for Hanging Feeders
914001	084369091503	Bail Handles for Hanging Feeders

9832, 9833, 9835, 9838 Galvanized Poultry Waterers

983207	084369096119	Slit Rubber Gasket
--------	--------------	--------------------

PHF11 & PFH22 Plastic Poultry Feeders

PHF3KIT	084369152600	Hanging Kit for PHF3
PHF11KIT	084369096591	Hanging Kit for PHF11
PHF22KIT	084369096621	Hanging Kit for PHF22

PPF3, PPF5 & PPF7 Plastic Poultry Waterers

PPF302	084369301121	Poultry Jar Base
PPF305	084369301152	Mold Rite Black Cap
PPF308	084369301176	4" Black Cap
PPF310KIT	084369096195	3 O-Rings, 1 PPF305

2500, 2525 & 2550 Plastic Poultry Waterers *See Figure 4 on page 86*

2506	A	084369250603	Water Valve
2507	B	084369250702	Brass Fountain Post
2508	C	084369250801	Regular Bowl
2509	D	084369250900	Stem Assembly Less Post
2509C		084369990110	Stem Assembly With Post
2510		084369251006	Brass Screen 50 X 60 Mesh
2511		084369251105	3/4" Gasket Plain Rubber
2512		084369990134	Brass Rivet
2514		084369251402	Control & Lock Nut
2515	E	084369251501	Chick Bowl
2516		084369251600	Control Spring
2518		084369251808	4 In 1 Tool
2532	F	084369253208	King Size Bowl
2538		084369253802	5/16" Internal Lock Washer

Incubators & Egg Turners

5203		084369520300	4 X 8 Window
5233		084369990219	Red Plug
6301		084369157483	Six Large Egg Rails Boxed
6303		084369157506	Thermometer Kit
6305		084369157513	Motor Replacement for 6300 & 6400
6306		084369157681	Large Egg Rails for 6300
7300		084369170987	Circulated Fan Kit
8300		084369173599	Heating element for 9300 - no fan
12350		084369177283	CSA-listed 24V Heater Kit for 12300 w Fan
165341		084369165341	New Rounded Corners Incubator Bottom
167741		084369167741	Incubator Power Cord
173292		084369173292	Digital Controller Assembly Kit
173308		084369173308	Incubator Sensor Assembly Kit
176750			CSA-listed Power Cord for 12300 Incubator
177276		084369177276	CSA-listed 24 V Controller Kit

Hot-Shot® Parts *See Figure 5 on page 85*

HS2	731141001150	Green Case W/O End Cover
HS4	731141001174	Green Case W/End Cover
SS2	731141000740	Red Case W/O End Cover
SS4	731141000818	Red Case W/End Cover
ECBLK	731141501605	Black Case End Cover

(for use on HS & SS style prods)

ITEM NUMBER UPC PRODUCT DESCRIPTION

Hot-Shot® Parts *See Figure 5 on page 85*

PL5P1	731141000856	Black Nut W/Blk Insert
SS14	731141000900	White Safety Clip & Thong
SS7P1	731141000870	Brass Hold Down Nut Bag
SS8P1	731141000887	Protective Boot In Pkg
KIT1	731141001648	Parts Kit: 1 ECBLK, 2 SS14 & 2 PL5P1

Galvanized Nesting Boxes

GNBSKT	084369186773	Replacement Basket
--------	--------------	--------------------

Wire Crates, Exercise Pen & Barrier

150897	084369150897	Plastic Handle for Wire Crates/Exercise Pens
--------	--------------	--

Plastic Crates

157001	084369157001	Hardware Kit for Plastic Crates
--------	--------------	---------------------------------

EF3, PW5 & PW13 Automatic Waterers

165600KIT	084369166799	Float Assembly Replacement Kit
-----------	--------------	--------------------------------

AH Rabbit Hutches

AH242407	084369995214	J Hook for Rabbit Hutch
AH242408	084369157582	Door Guard
AH242409	084369995207	Spring for Rabbit Hutch

API® Replacement Parts

75	022102750003	EZ-Tilt Deck Mount for 14B & 645
292428	022102292428	Bowl for 400
294125	022102294125	Bracket for 600
294132	022102294132	Hardware Kit for 600
293494	022102293494	89 Ring for 850 & 970
301335	022102304909	Potting Assembly for 400
8WW-B	022102000160	Battery for 8WW
297768	022102297768	77 Thermostat for 77UH
298956	022102298956	Element for 77UH
295177	022102295177	Tankside Thermostat for 71502
298949		Element 71502
295795	022102295795	Nut for 2002DP Drain Plug De-Icer
296723	022102296723	Rubber Seal for 2002DP De-Icer
301359	022102301359	Element for SB50
300888	022102300888	Water Wiggler Spinner Assembly
BBSTAND	022102304435	Bird Bath Stand for 970

Springer Magrath® *See Figure 6 on page 85*

BRASSBUSHING	659276912625	CPS Brass Bushing
BTMCAP	659276912694	CPS Bottom Cap
CPSHOSE	659276912830	CPS Finished Hose
CPSREDBAG	659276912908	CPS 17" x 37" 17 oz. Carry Bag
CPSTH	659276912977	CPS T-Handle
CPSWASHER	659276913042	CPS Hose Washer
ERING	659276913110	CPS E Ring
FEMALEEND	659276913189	CPS Female End
MALEEND	659276913530	CPS Male End
NLCLAMP	659276902473	CPS Nose Lead Clamp
NOSELEAD	659276913608	CPS Nose Lead Finished
ORING	659276913677	CPS O Ring
PLUNGERSEALS	659276913745	CPS Cap Plunger Seal
TOPCAP	659276914162	CPS Top Cap Assembly

Poultry Dome Waterers

188210	84369188210	O-Ring Black For Dome Waterer Lid
188227	84369188227	Handle Dome Waterer
188234	84369188234	Plug For Dome Waterer

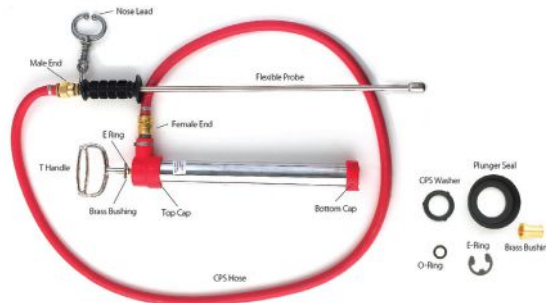
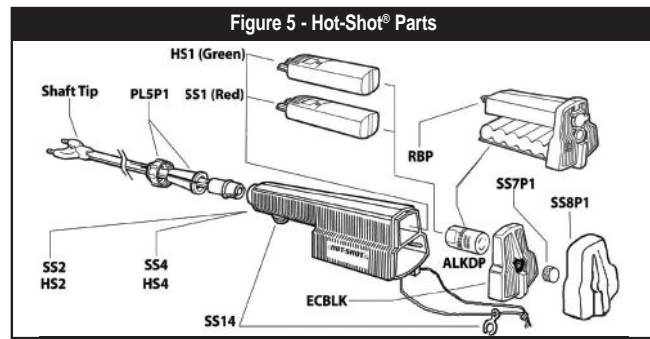
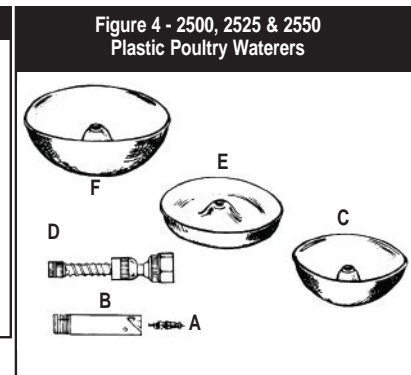
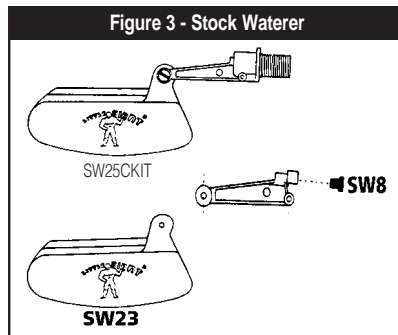
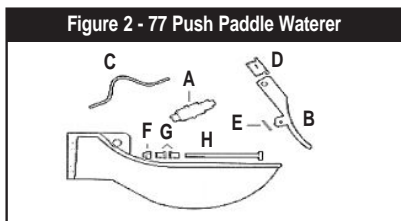
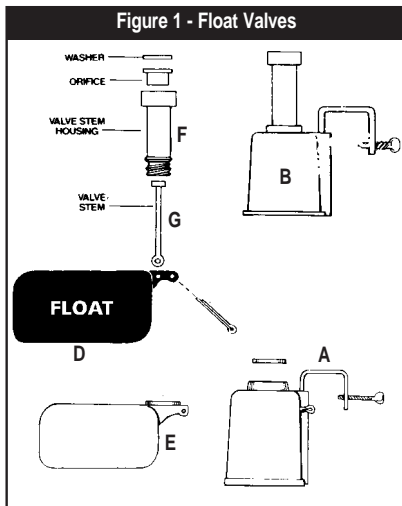

Figure 6 - Springer Magrath®

Miller Manufacturing Standard Warranty

Miller Manufacturing Company products are warranted to the original purchaser to be free from defects in material and workmanship under normal use and service. Miller's obligations under this Warranty shall be limited to the repair or exchange of any part of parts which may thus prove defective under normal use and service within 30 days from the date of shipment by Miller to the original purchase, and which Miller's examination shall disclose to its satisfaction to be thus defective.

DISCLAIMER: Due to the numerous factors relating to the hatching of eggs, Miller Manufacturing Company makes no warranty whatsoever in respect to the number of eggs that will be hatched using the Little Giant® brand incubators or egg turners. The warranty is expressly in lieu of all other warranties expressed or implied including the warranties of merchantability and fitness for use and all other obligations or liabilities on our part. We neither assume nor authorize any other person to assume for us, any other liability in connection with the sale of Miller products or any part thereof which has been subject to accident, negligence, alteration, abuse, or misuse. We make no warranty whatsoever in respect to accessories or parts not supplied by us. The above warranty applies to all Miller Manufacturing products unless otherwise specified.

API® Products

All products in the API® line are fully warranted against defects in workmanship for a period of one year from date of purchase, unless otherwise noted.

Hot-Shot® Prods

Hot-Shot® maintains a complete repair service at the factory. If a Hot-Shot® product fails due to a defect within the specified warranty period, the unit must be returned to the factory for examination. If the product is found to be defective and is within the warranty period, replacement or repairs will be made. The product will be returned postage paid.

This warranty does not include case breakage or any form of physical damage, or damage due to normal wear and tear or tampering with the handle or motor unit.

Springer Magrath® Standard Warranty

Springer Magrath® products are warranted to the original purchaser to be free from defects in material and workmanship under normal use and service. Springer's obligations under this Warranty shall be limited to the repair or exchange of any part or parts which may thus prove defective under normal use and service within 30 days from the date of shipment by Springer to the original purchaser, and which Springer's examination shall disclose to its satisfaction to be thus defective.

Springer Magrath® Stock Prods

Springer Magrath® Stock Prods are not part of the warranty shown above, but are covered under a separate warranty which states that the electronic module is guaranteed for 14 months from date of manufacture. The Stock Prod warranty does not include the shaft, casing breakage, any form of physical damage, or damage due to normal wear and tear or tampering with the power pack.

DISCLAIMER: This warranty is expressly in lieu of all other warranties expressed or implied including the warranties of merchantability and fitness for use and all other obligations or liabilities on our part. We neither assume nor authorize any other person to assume for us, any other liability in connection with the sale of Springer products or any part thereof which has been subject to accident, negligence, alteration, abuse or misuse. We make no warranty whatsoever in respect to accessories or parts not supplied by us.



Poultry Waterers & Feeders

These poultry products are designed to help you reach your expanding consumer base, including both newcomers to backyard poultry and backyard enthusiasts interested in different sizes, features, and price points.

DT9857 1.5 Quart/1.5 Liter Plastic Poultry Waterer

L 7.37" x W 7.37" x H 7.62" • 6 pk

DT9858 3.5 Quart/3 Liter Plastic Poultry Waterer

L 9.25" x W 9.25" x H 9.25" • 6 pk

DT9862 2.5 Gallon/10 Liter Plastic Poultry Waterer

L 14" x W 14" x H 12.75" • 6 pk

DT9854 1.5-lb. Plastic Poultry Feeder

L 7.37" x W 7.37" x H 5.75" • 6 pk

DT9855 5-lb. Plastic Poultry Feeder

L 9.25" x W 9.25" x H 8.25" • 6 pk

DT9856 15-lb. Large Plastic Poultry Feeder

L 14" x W 14" x H 11" • 6 pk

DT809 Small Plastic Ground Feeder

L 8" x W 3.5" x H 2.5" • 6 pk

The perfect size for a small flock of chicks. Covered top. Individual holes minimize feed waste. 8" long.

DT9851 18" Galvanized Trough Feeder

L 17.875" x W 5.875" x H 5.375" • 6 pk

Made from sturdy galvanized steel for durability, and features rolled edges for safety. The large 18" trough area holds up to 3 lbs. of feed. Rear hooks allow for easy hanging in the coop or hutch.



One-piece construction of the jar and built-in Feed Saver Ring

Poultry Waterers With Legs

Perfect for starting your small flock of chicks. Start with the removable legs detached and as the birds get larger, add the legs to raise the waterer off the ground. Keeping the waterer off the ground helps prevent the birds from filling the waterer base with dirt and debris during their foraging and scratching. This waterer is molded from durable plastic for years of use. The translucent plastic body makes it quick and easy to check the water level.

DT9870 1.5 Quart/1.5 Liter Poultry Waterer with Legs

L 8.75" x W 7.25" x H 7.25" • 5 pk

DT9872 3 Quart/3 Liter Poultry Waterer with Legs

L 10.875" x W 9.25" x H 9.25" • 5 pk

DT9874 1 Gallon/5 Liter Poultry Waterer with Legs

L 13.5" x W 11" x H 11" • 5 pk

DT9876 2 Gallon/8 Liter Poultry Waterer with Legs

L 15" x W 12.5" x H 12.5" • 5 pk

DT9878 2.5 Gallon/10 Liter Poultry Waterer with Legs

L 16.25" x W 13.75" x H 13.75" • 5 pk



Beginner Poultry Kit: more information on page 42

Poultry Feeders with Legs

This is a great poultry feeder designed exclusively for the hobbyist. Start with the removable legs detached for chicks and as the birds get larger, add the legs to raise the waterer off the ground. The built-in Feed Saver Ring minimizes spillage and prevents wasted food. Durable one-piece construction of the jar and Feed Saver Ring for quick and easy assembly. Made of impact-resistant plastic that won't rust or corrode. The included plastic lid protects the feed from the elements. Handy carrying handle.

DT9871 4 lb. Poultry Feeder with Legs

L 11.75" x W 9.5" x H 9.5" • 5 pk

DT9873 8.5 lb. Poultry Feeder with Legs

L 14.75" x W 11.5" x H 11.5" • 5 pk

DT9875 17.5 lb. Poultry Feeder with Legs

L 17.75" x W 15" x H 15" • 5 pk

DT9877 26 lb. Poultry Feeder with Legs

L 20" x W 17.5" x H 17.5" • 5 pk

DT9879 35 lb. Poultry Feeder with Legs

L 25" x W 18" x H 18" • 5 pk





Salt Block Holders & Mineral Feeders

Double-Tuf® salt block holders and mineral feeders are made of tough, impact resistant, high-density polyethylene which protects against warpage, stress cracks and UV damage. These products help eliminate waste of salt, protein or mineral blocks.



DT00114 1 Quart Salt Block Feeder

L 9.31" x W 6.06" x H 5.56"

Feeder holds standard 4 lb salt or mineral block. Raised ribs and drainage holes keep blocks dry. Contoured mounting plate has holes to allow for permanent mount.



DT00117 1 Quart Mineral Feeder

L 9.19" x W 5.56" x H 5.5"

Simplifies measurement and consumption of multiple minerals. Divider for two types of granular minerals. Screw holes for easy installation.



DT00115 10 Quart Salt Block Pan

L 18.06" x W 18.06" x H 5.28"

Radial ribs protect salt block from water and moisture. Holes allow water to drain. Hand grips for easy handling.

DT00116 Universal Block Holder

L 12.63" x W 14.25" x H 9.69"

Unique design allows for feeding protein blocks, salt blocks, loose minerals and feed grain for goats, cattle and equine. Animals cannot gnaw on corners or knock block out of the holder, reducing waste and saving money. Universal secure mounting on wire livestock panels or 2-by board.



Feed Scoops

The Double-Tuf® feed scoops feature an ergonomic design which provides easy transitioning of feed.



DT00130 3 Quart Feed Scoop

L 10.44" x W 6.81" x H 5.87"

Ergonomic handle is easy on your wrist.



GT00290 3 Quart Galvanized Feed Scoop

L 6.38" x W 9.38" x H 8.63"

Heavy-duty galvanized construction to prevent rust and corrosion. Ergonomic handle is easy on your wrist.

Nursing Supplies

The Double-Tuf® calf pail is made of tough, impact resistant, high-density polyethylene which protects against warpage, stress cracks and UV damage.



Replacement nipple available. Part # DT00238

DT00212 8 Quart Calf Pail

L 11.31" x W 11.19" x H 8.13"

Includes standard nipple package and optional bracket for easy mounting. Interior valve designed to remove milk from bottom of bucket.



Plastic Buckets, Tubs & Feeders

The Double-Tuf® plastic buckets, tubs and feeders are made from tough, impact-resistant, high-density polyethylene with smooth, finished edges. Rims are strengthened with extra plastic or steel inserts where necessary to prolong handle life.



8 Quart Flat-Sided Bucket
L 11.75" x W 10.75" x H 8.19"
Features an easy to pour lip and hand-hold. Channel wraps around most poles or posts. Hangs flat against any wall. Available in blue (DT00223), green (DT00222) and red (DT00221).



20 Quart Flat-Sided Bucket
L 14" x W 15.5" x H 12.69"
Channel wraps around most poles or posts. Hangs flat against any wall. Available in blue (DT00150), green (DT00152), hotpink (DT00156), limegreen (DT00154), purple (DT00153) and red (DT00151).



8 Quart Utility Bucket
L 11.31" x W 11.19" x H 8.13"
Handles have heavy-duty plated steel eyelets. Multi-purpose bucket. Available in black (DT00204), blue (DT00202), green (DT00220), purple (DT00203) and red (DT00201).



DT00205 7.5 Gallon 3-Snap Feed Tub
L 17.63" x W 17.63" x H 12.75"
Handles include heavy-duty plated steel eyelets. Metal hooks attach for easy hanging. Available in green.



5 Quart Utility Pan
L 12" x W 12" x H 4.13"
Features comfortable handles and easy-pour spout. Low profile prevents tipping. Available in blue (DT00233), green (DT00230) and red (DT00232).



DT00216 18 Quart Feed Pan
L 20" x W 18.5" x H 7.25"
Features large opening for easy access. Easy to clean. Comfortable carrying handles. Available in green.



DT00218 3 Gallon Anti-Spill Pan
L 18.5" x W 18.38" x H 4.75"
Low profile and wide base for stability. Tapered sides reduce tipping. For feeding and watering all livestock. Available in black.



40 Quart Muck Bucket
L 19.31" x W 17.66" x H 13.69"
Multi-purpose bucket with nylon rope handles. Great for various barn and stable uses, or around the house or yard. Available in blue (DT00215), green (DT00209) and red (DT00211).



70 Quart Muck Bucket
L 23.66" x W 21.25" x H 15.5"
Multi-purpose bucket with nylon rope handles. Great for various barn and stable uses, or around the house or yard. Available in blue (DT00206), green (DT00208) and red (DT00219).



Plastic Buckets, Tubs & Feeders (Continued)



8 Quart Hook'N Feed
L 13.69" x W 10.47" x H 9.69"
 Reinforced with fiberglass for extra durability. Durable molded brackets hang easily over any 2-by board. Easy to pour lip and hand-hold. Available in blue (DT80000), green (DT80005), purple (DT80020) and red (DT80010).



14 Quart Hook'N Feed
L 15.25" x W 11.5" x H 12.69"
 Reinforced with fiberglass for extra durability. Heavy-duty molded brackets hang easily over any 2-by board. Easy to pour lip and hand-hold. Available in blue (DT08113), green (DT07113), hotpink (DT02113), limegreen (DT01113), purple (DT05113), black (DT09113) and red (DT06113).



2 Pack - 12 Quart Hook'N Feed
L 15.38" x W 12.19" x H 11.5"
 Great value! This product is two 12 quart Hook'N Feeds cable-tied together. Reinforced with fiberglass for extra strength. Durable molded brackets hang easily over any 2-by board. Features easy to pour lip and hand-hold. Available in hotpink (DT03116), limegreen (DT03114) and orange (DT03115).



6 Quart Mini Feeders
L 10.88" x W 9.88" x H 5.5"
 Hooks well on fence or rail. Pre-drilled holes for easy installation. Rounded lip for durability. Available in blue (DT00237), green (DT00210) and red (DT00236).



DT00109 9 Quart Foal Feeder
L 11.5" x W 11.19" x H 9.13"
 Pre-drilled mounting holes for easy installation. Adjustable bars prevent large horses from eating foal's feed. Available in green.



DT00108 24 Quart Corner Feeder
L 18.31" x W 16.06" x H 9.63"
 Pre-drilled mounting holes for easy installation. Designed to reduce feed loss. Rounded for easy feeding and safety. Available in green.



DT00106 9 Quart Hook Over Goat Trough
L 47.38" x W 13.5" x H 9.56"
 Unique design helps reduce feed waste while promoting animal safety and improved health. Universal secure mounting on wire livestock panels or 2-by board. Galvanized steel grid adds strength and keeps boss animals from pushing others out while eating. Reinforced hooks provide extra support on ends of feeder. Available in black.



DT00214 52 Quart Hook Over Trough
L 37.75" x W 8.44" x H 4.72"
 High-volume capacity for large feeding jobs. Strong hooks fit over most fencing. Reinforced with fiberglass for extra durability. Available in black.





Rubber Buckets, Tubs & Feeders

The Double-Tuf® rubber buckets, tubs and feeders are made from both recycled and natural rubber. These rubber products are safe and soft for use with your animals.



RT00257 8 Quart Rubber Bucket
L 11.5" x W 11" x H 9"
Made of safe, soft rubber. Features strong wire handle and reinforced rim.



RT00258 10 Quart Rubber Bucket
L 13.13" x W 12.5" x H 10.19"
Made of safe, soft rubber. Features strong wire handle and reinforced rim.



RT00260 12 Quart Rubber Flat-Sided Bucket
L 13.88" x W 13.31" x H 10.56"
Features strong wire handle and reinforced rim. Hangs well against any flat surface.



RT00264 18 Quart Rubber Flat-Sided Bucket
L 15.25" x W 15.63" x H 11.94"
Features strong wire handle and reinforced rim. Hangs well against any flat surface.



RT00256 20 Quart Rubber Corner Bucket
L 16" x W 17.63" x H 11"
Made of safe, soft rubber. Features handle for easier carrying. Nests tightly into corners.



RT00241 6.5 Gallon Rubber Utility Tub
L 18.63" x W 18.19" x H 8.06"
General purpose tub. Made of safe, soft rubber. Features reinforced rim.



RT00252 2 Quart Rubber Pan
L 8.91" x W 8.91" x H 3.78"
General purpose pan. Made of safe, soft rubber. Features reinforced rim.



RT00242 4 Quart Rubber Pan
L 11.12" x W 11.12" x H 3.97"
General purpose pan. Made of safe, soft rubber. Features reinforced rim.



RT00244 8 Quart Rubber Pan
L 14.93" x W 14.93" x H 4.75"
General purpose pan. Made of safe, soft rubber. Features reinforced rim.



RT00254 3 Gallon Rubber Pan
L 17.25" x W 17.25" x H 5.06"
General purpose pan. Made of safe, soft rubber. Features reinforced rim.





Rubber Buckets, Tubs & Feeders (Continued)



RT00250 15 Gallon Rubber Pan
L 25.88" x W 25.88" x H 9.88"
 General purpose pan. Made of safe, soft rubber. Features reinforced rim.



RT00248 6.5 Gallon Rubber 3-Loop Pan
L 18.63" x W 18.19" x H 8.5"
 Made of safe, soft rubber. Features strong eyelets for hanging and reinforced rim.



RT00255 16 Quart Rubber Hookover Feeder
L 16.09" x W 13.09" x H 9.12"
 Made of safe, soft rubber. Hooks over any 2-by board. Features reinforced rim.



RT00246 6.5 Gallon Rubber Pan with Handles
L 21.09" x W 18.5" x H 9.84"
 General purpose pan. Made of safe, soft rubber. Features reinforced rim and handles for easy carrying.



RT00253 3 Gallon Rubber Pan with Handles
L 20.25" x W 17.38" x H 6.91"
 General purpose pan. Made of safe, soft rubber. Features reinforced rim and handles for easy carrying.

Live Trap Combo

This combo pack features two traps in the most popular sizes. Both are Single-Door Entry Live Traps that catch unwanted animals without injury so they can be humanely disposed of or relocated. Features a spring-loaded door that is easy to bait and set and quick to release. Beneath the convenient carrying handle is a steel plate to protect hands from contact with the animal. Larger size measures 32.5 inches long by 11 inches wide by 12.5 inches high, and works great for raccoons, porcupines, turtles, foxes, and other similar-size animals. Smaller size measures 24 inches long by 7 inches wide by 7 inches high, and is best for squirrels, chipmunks, rabbits, muskrats, mink, and other similar-size animals.

ELT42 Live Trap Combo Pack
L 32.5" x W 11" x H 12.5" (Large Trap)
L 24" x W 7" x H 7" (Small Trap) • 1pk

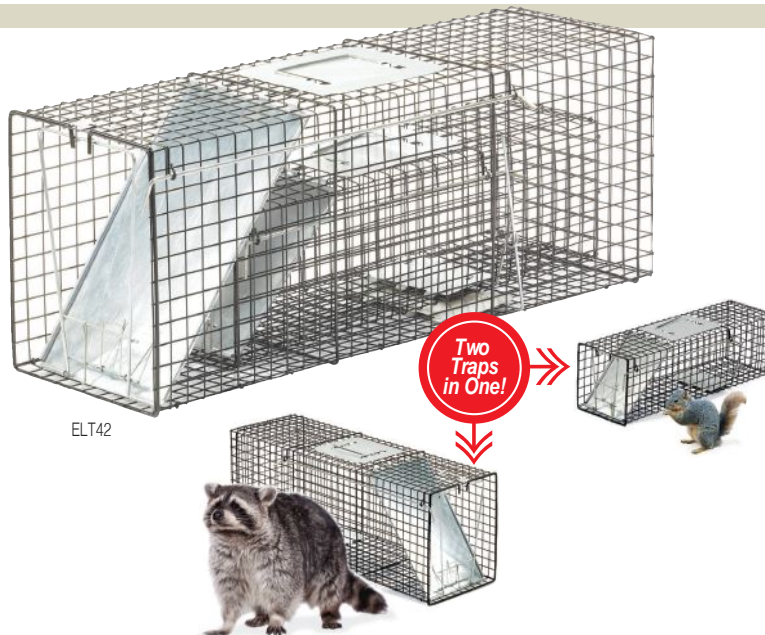



Miller Offers a Container Direct Program!

While we produce the majority of our farm and ranch items in the United States, there are a few items we purchase from overseas manufacturers. Some of these items can be purchased through our Glencoe, Minnesota warehouse, but they are purchased more cost-effectively if they are shipped directly from the manufacturer to the customer's warehouse.

Customers can choose to ship a full container of one product category (plastic buckets, for example) or mix and match categories from the same factory on one container. Contact your Miller Sales VP for more information on container direct products.



Item #	Description
PLASTIC DOG CRATES	
157292	Small Plastic Pet Crate
157308	Medium Plastic Double-Door Pet Crate
157315	Large Plastic Double-Door Pet Crate
157322	X-Large Plastic Double-Door Pet Crate
157339	Giant Plastic Double-Door Pet Crate
WIRE DOG CRATES	
WCXSM	Extra Small Single-Door Wire Crate - Black
WCSML	Small Single-Door Wire Crate - Black
WCMED	Medium Double-Door Wire Crate - Black
WCLRG	Large Double-Door Wire Crate - Black
WCXLG	X-Large Double-Door Wire Crate - Black
WCGNT	Giant Double-Door Wire Crate - Black
EXERCISE PENS	
100403	24" Exercise Pen
100441	30" Exercise Pen
100410	36" Exercise Pen
153218	42" Exercise Pen
100427	48" Exercise Pen
VEHICLE BARRIER	
100434	Wire Vehicle Barrier
PET BEDS	
179925	Extra Small 18" Fleece Bed - Cream
152235	Small 23" Fleece Bed - Cream
152242	Medium 29" Fleece Bed - Cream
152259	Large 35" Fleece Bed - Cream
152266	X-Large 41" Fleece Bed - Cream
152273	Giant 47" Fleece Bed - Cream
160742	Small 23" Fleece Bed - Chocolate
160759	Medium 29" Fleece Bed - Chocolate
160766	Large 35" Fleece Bed - Chocolate
160773	X-Large 41" Fleece Bed - Chocolate
160780	Giant 47" Fleece Bed - Chocolate

Item #	Description
GALVANIZED BUCKETS, TUBS, FEEDERS AND GARBAGE CANS	
GP3P	3 Pint Galvanized Pail
GP5	5 Quart Galvanized Dairy Pail
GP8	8 Quart Galvanized Dairy Pail
GCP8	8 Quart Galvanized Calf Pail
GCPH	8 Qt Galvanized Calf Pail Hookover
GP10	10 Quart Galvanized Dairy Pail
GP12	12 Quart Galvanized Dairy Pail
GP14	14 Quart Galvanized Dairy Pail
GWT425	4.25 Gallon Galvanized Round Tub
GBT8	Galvanized Bushel Tub - 8 gal
GWT1375	13.75 Gallon Galvanized Round Tub
GWT1675	16.75 Gallon Galvanized Round Tub
GOT2	2 Gallon Galvanized Oval Tub
GOT4	4 Gallon Galvanized Oval Tub
GOT55	5.5 Gallon Galvanized Oval Tub
GOT75	7.5 Gallon Galvanized Oval Tub
GOT105	10.5 Gallon Galvanized Oval Tub
GOT16	16 Gallon Galvanized Oval Tub
GWT105	10.5 Gallon Galvanized Round Tub
GWT15	15 Gallon Galvanized Round Tub
GST16	16 Gallon Galvanized Square Tub
GGC6	6 Gallon Galvanized Storage Bin
GGC10	10 Gallon Garbage Can
GGC20	20 Gallon Garbage Can
GGC31	31 Gallon Garbage Can









Item #	Description
--------	-------------















GALVANIZED BUCKETS, TUBS, FEEDERS AND GARBAGE CANS





	GWC10 10 Quart Galvanized Watering Can
	168779 Basic Goat & Sheep Feeder
	168793 Classic 2-in-1 Feeder
	168830 Hay Grazer

STAINLESS STEEL DAIRY PAILS



	SS9P 9 Quart Stainless Steel Dairy Pail
	SS13P 13 Quart Stainless Steel Dairy Pail
	SS16P 16 Quart Stainless Steel Dairy Pail
	SS20P 20 Quart Stainless Steel Dairy Pail

PLASTIC BUCKETS, TUBS AND FEEDERS

	B10BLACK 10 Quart Plastic Better Bucket
	BB10BLUE 10 Quart Plastic Better Bucket
	BB10GREEN 10 Quart Plastic Better Bucket
	BB10RED 10 Quart Plastic Better Bucket
	BB20BLACK 20 Quart Plastic Better Bucket
	BB20BLUE 20 Quart Plastic Better Bucket
	BB20GREEN 20 Quart Plastic Better Bucket
	BB20RED 20 Quart Plastic Better Bucket
	FT11BLUE 11 Gallon FlexTub Poly/Rubber
	FT11GREEN 11 Gallon FlexTub Poly/Rubber
	FT11HOTPINK 11 Gallon FlexTub Poly/Rubber
	FT11LIMEGREEN 11 Gallon FlexTub Poly/Rubber
	FT11RED 11 Gallon FlexTub Poly/Rubber
	FT11PURPLE 11 Gallon FlexTub Poly/Rubber

	FP10GREEN 10 Quart Tire Feeder
	HF52BLACK 52 Quart Hookover Trough
	HF9BLACK 9 Quart Hookover Goat Trough
	SBPU Universal Block Holder Black
	MF1GREEN 1 Quart Mineral Feeder Green
	SBP3 1 Quart Salt Block Feeder Green
	PT20BLACK 20 Gallon Utility Tub













RUBBER PANS

	DF3D 3 Gallon Rubber Pan with Handles
	DF650D 6.5 Gallon Rubber Tub with Handles



Item #	Description
--------	-------------

RUBBER FLOORING

	RM3660 Rubber Mat 36" x 60"
	RM4096 Rubber Mat 40" x 96"
	RM4872 Rubber Mat 48" x 72"
	RM4896 Rubber Mat 48" x 96"
	RM6096 Rubber Mat 60" x 96"
	RM60120 Rubber Mat 60" x 120"
	RMRACK Rubber Mat Rack 5 Slots
	RMIL3636 Trak-Safe Interlocking Mat - 36" x 36" x 0.6" H
	RMWR349 Wide Ribbed Roll 49' L x 3.25' W x 0.15" H
	RMDOT349 Round Dot Roll 49' L x 3.25' W x 0.15" H
	RMDIA380 Check Plate Roll 80' L x 3' W x 0.125" H
	RMDIA440 Check Plate Roll 40' L 4' W x 0.25" H
	RM3DISP 3 Roll Rubber Display with Cutter

SPRAYER BOOM

169516	Sprayer Boom
--------	--------------

BROODER LAMPS AND BULBS

	170017 Brooder Reflector Lamp
	170024 Red Heat Lamp Bulb
	170031 Clear Heat Lamp Bulb



Item #	Description
--------	-------------

	DOUBLE-TUF® ELT42 Live Trap Combo Pack
	DOUBLE-TUF® POULTRY DT9857 1.5 Quart/1.5 Liter Plastic Poultry Waterer
	DT9858 3.5 Quart/3 Liter Plastic Poultry Waterer
	DT9862 2.5 Gallon/10 Liter Plastic Poultry Waterer
	DT9854 1.5-lb. Plastic Poultry Feeder
	DT9855 5-lb. Plastic Poultry Feeder
	DT9856 15-lb. Large Plastic Poultry Feeder
	DT9851 18" Galvanized Trough Feeder