



ASSEMBLY INSTRUCTIONS

8' x 15' OUTDOOR STORAGE SHED

ITM./ART. 123373

Lifetime® sheds are designed to be strong and durable. We strive to make assembly as easy as possible without compromising quality. If you get stuck, we have tools to help:

- **Build a Foundation**
Construct a level surface before you start (see page 6 for instructions).
- **Recruit Friends and Family**
Assembly should take 3 people about 4–6 hours to complete.



TOOLS REQUIRED



TABLE OF CONTENTS

| | |
|----------------------------|----|
| Icon Legend..... | 4 |
| Warnings & Notices..... | 5 |
| Platform Construction..... | 6 |
| Truss Assembly..... | 11 |
| Gable Assembly..... | 16 |
| Door Assembly..... | 20 |
| Floor Assembly..... | 29 |
| Wall Assembly..... | 33 |
| Parts Identifier..... | 37 |
| Shelving Installation..... | 41 |
| Door Installation..... | 46 |
| Roof Assembly..... | 50 |
| Window Installation..... | 60 |
| Door Alignment..... | 63 |
| Shed Anchoring..... | 66 |
| Cleaning & Care..... | 71 |
| Registration..... | 72 |
| Warranty..... | 73 |



ICON LEGEND



- Indicates special heed should be taken when reading.



- Indicates the parts to be used for a section.



- Indicates no parts required for a specific section.



- Indicates the hardware to be used for a section.



- Indicates no hardware required for a specific page.



- Indicates the tools to be used for a section.



- Indicates to use/not to use an electric drill for a specific step.



WARNINGS & NOTICES

English:

- **Failure to follow these warnings may result in serious injury or property damage and will void warranty.**
- To ensure safety, do not attempt to assemble this product without following the instructions carefully.
- Consult all local building codes to verify if the shed requires a building permit.
- Verify the foundation is completely level before assembling the shed.
- Be aware that plastic pieces can be damaged by overtightening the screws. To avoid damage, we strongly recommend the use of a drill with a low torque setting. A #2 Phillips screwdriver may also be used.
- Three capable adults are required for assembly.
- All who participate in the assembly process should wear safety glasses throughout the assembly.
- If using a ladder during assembly, use extreme caution.
- In heavy snowfall areas, we recommend removing snow from the roof.
- Do not use or store hot objects near the product.
- Proper and complete assembly are essential to reduce the risk of accident or injury.
- We strongly recommend anchoring your shed when it is finished. The last section, Shed Anchoring, in this manual shows the hardware you'll need to complete the anchoring. You can find the hardware at your local hardware store.
- **Most injuries are caused by misuse and/or not following instructions. Use caution when using this product.**

1

PLATFORM CONSTRUCTION



• You must provide a platform on which to assemble your shed. Proper building permit documentation may be required in your neighborhood. Consult all local building codes prior to assembling the shed. Before beginning assembly, you must pour or construct a platform. There are two types:

- **Concrete**
- **Wood Frame**

Select the type, but know the surface must be leveled and flat before installation. If the surface is not properly leveled and flat, the shed will not assemble correctly. Proper surface leveling will save you time in the long run, so please do not ignore this step.

We recommend a Concrete platform. It will be the most durable and long-lasting choice. The platform you choose must be built above ground in order to avoid water pooling inside the shed. All lumber must be rated for outdoor use!

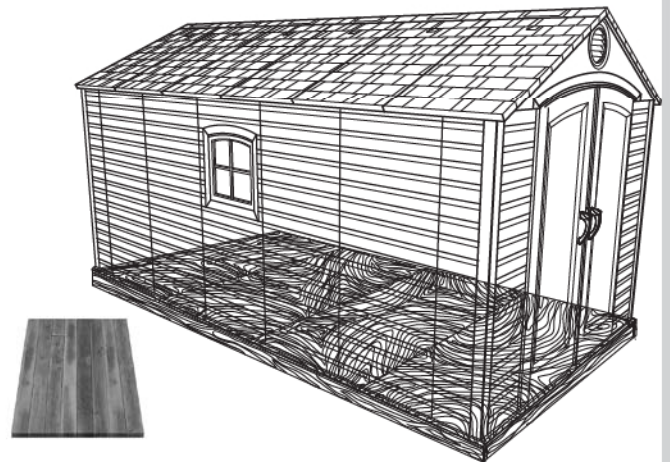
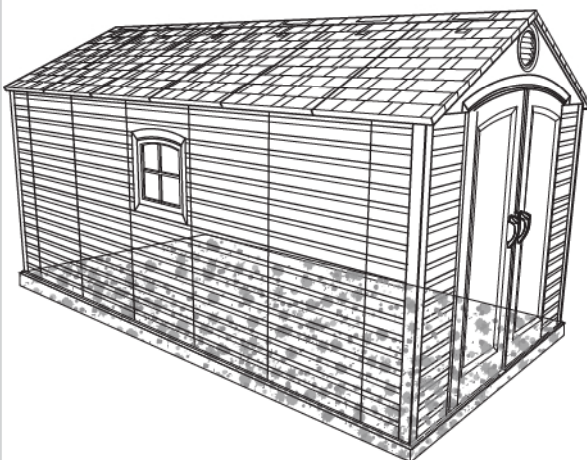

► SECTION 1 (CONTINUED) / SECCIÓN 1 (CONTINUACIÓN) / SECTION 1 (SUITE)

CONCRETE REQUIRED / CONCRETO REQUERIDO / BÉTON REQUIS



2 yd³ (1,53 m³)

1.1

CONCRETE PLATFORM / PLATAFORMA DE CONCRETO / PLATE-FORME EN BÉTON

- The concrete should be approximately 4" (10,2 cm) thick. The actual dimensions of the shed, at its widest and longest points, are 96" x 180" (2,44 m x 4,57 m). Ensure you select a site that will accommodate these measurements. **The floor dimensions are a bit smaller than those of the roof; therefore, you will need to build a level surface of 93 1/2" x 178" (2,38 m x 4,52 m).**
- El concreto debe tener, por lo menos, 10,2 cm (4") de espesor. Las dimensiones reales de la caseta, a sus puntos más ancho y largo, son 2,44 m x 4,57 m (96" x 180"). Asegúrese de seleccionar un sitio que acomodará estas medidas. **Las dimensiones del piso de la caseta son más pequeñas que el tejado; entonces, necesitará crear una superficie nivel de 2,38 m x 4,52 m (93 1/2" x 178").**
- Le béton doit être un épaisseur de 10,2 cm (4"). Les dimensions réelles de votre abri, aux points les plus large et long, sont 2,44 m x 4,57 m (96" x 180"). Assurez-vous de sélectionner un site qui accommodera ces dimensions. **Les dimensions du plancher de votre abri sont plus petites que le toit; ensuite, il faut créer une surface horizontale de 2,38 m x 4,52 m (93 1/2" x 178").**

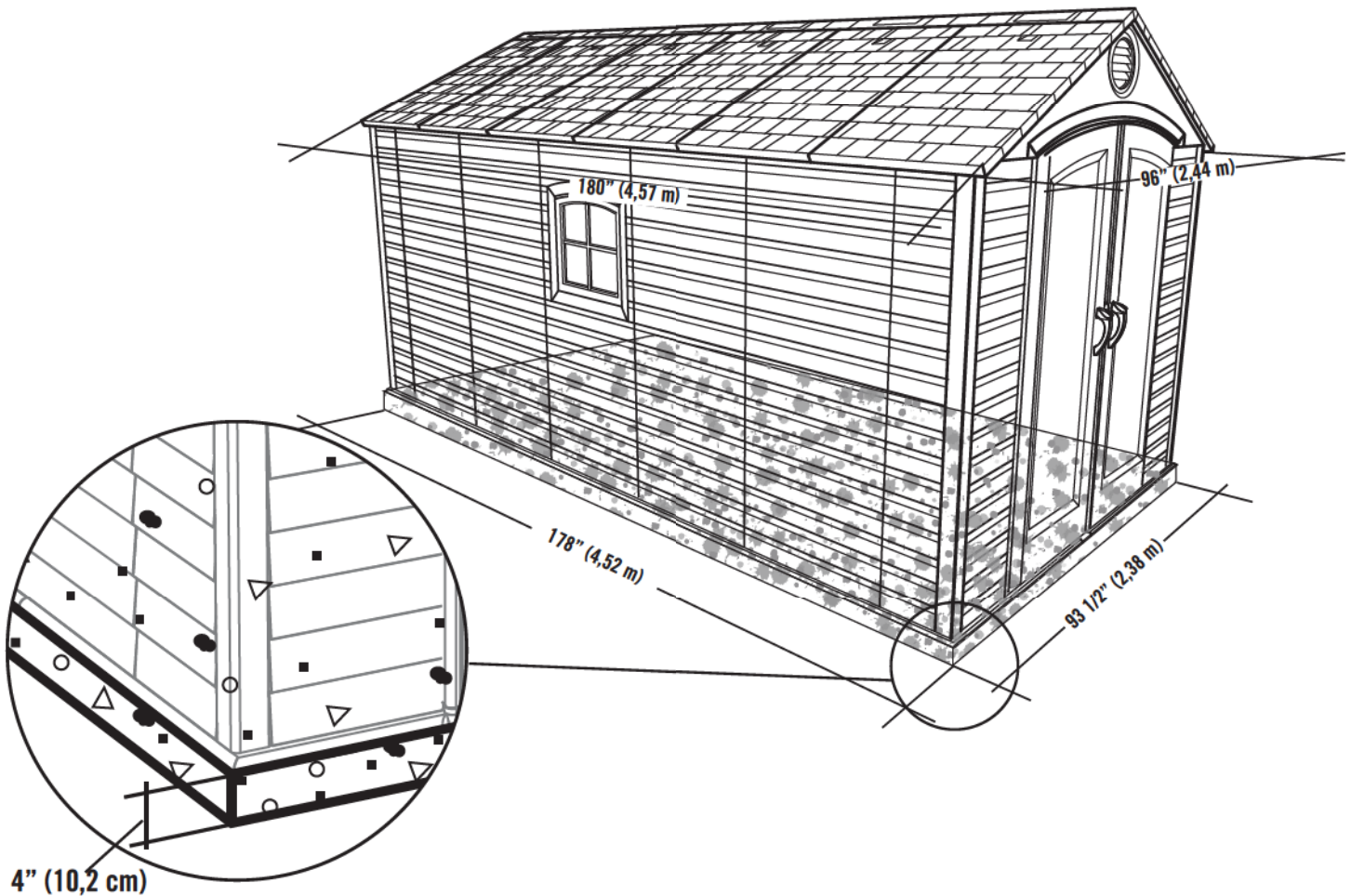

4" (10,2 cm)



► SECTION 1 (CONTINUED) / SECCIÓN 1 (CONTINUACIÓN) / SECTION 1 (SUITE)

WOOD REQUIRED / MADERA REQUERIDA / BOIS REQUIS



1.2

WOOD PLATFORM / PLATAFORMA DE MADERA / PLATE-FORME EN BOIS

- The actual dimensions of the shed, at its widest and longest points, are 96" x 180" (2,44 m x 4,57 m). Ensure you select a site that will accommodate these measurements. **The floor dimensions are a bit smaller than those of the roof; therefore, you will need to build a level surface of 93 1/2" x 178" (2,38 m x 4,52 m).**
- Las dimensiones reales de la caseta, a sus puntos más ancho y largo, son 2,44 m x 4,57 m (96" x 180"). Asegúrese de seleccionar un sitio que acomodará estas medidas. **Las dimensiones del piso de la caseta son más pequeñas que el tejado; entonces, necesitará crear una superficie nivel de 2,38 m x 4,52 m (93 1/2" x 178").**
- Les dimensions réelles de votre abri, aux points les plus large et long, sont 2,44 m x 4,57 m (96" x 180"). Assurez-vous de sélectionner un site qui accommodera ces dimensions. **Les dimensions du plancher de votre abri sont plus petites que le toit; ensuite, il faut créer une surface horizontale de 2,38 m x 4,52 m (93 1/2" x 178").**

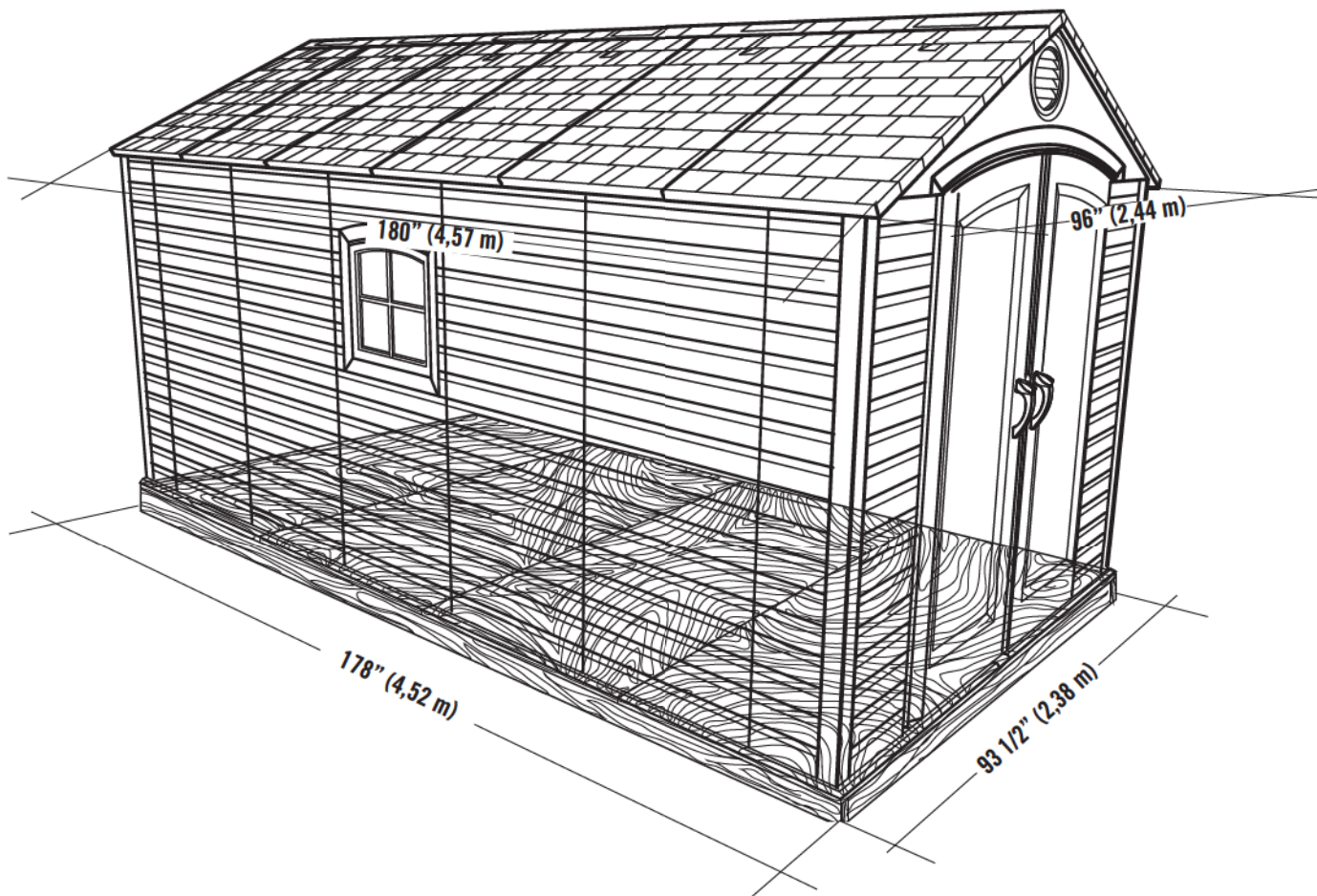

► SECTION 1 (CONTINUED) / SECCIÓN 1 (CONTINUACIÓN) / SECTION 1 (SUITE)

TOOLS, PARTS, AND HARDWARE REQUIRED / INSTRUMENTAL, PIEZAS, Y HERRAJE REQUERIDOS / OUTILS, PIÈCES, ET QUINCAILLERIE REQUIS



2" x 4" x 178" (5,1 cm x 10,2 cm x 4,52 m) (x2)



2" x 4" x 90 1/2" (5,1 cm x 10,2 cm x 2,30 m) (x13)

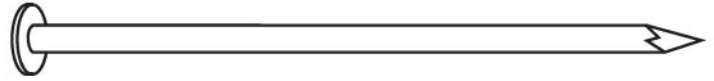

16d 3 1/2" (16d x 8,89 cm) (x52)

1.2.1

WOOD PLATFORM / PLATAFORMA DE MADERA / PLATE-FORME EN BOIS

- Ensure all lumber is treated and approved for outdoor use. Build frame to 93 1/2" x 178" (2,38 m x 4,52 m) (outside dimensions). You can also use the plywood as a flat surface when building this frame.
- Asegure que use madera tratada y aprobada para el uso externo. Construye el armazón a 2,38 m x 4,52 m (93 1/2" x 178") (dimensiones exteriores). Se puede también usar el contrachapado como una superficie plana al ensamblar este armazón.
- Vérifiez que votre bois d'œuvre à été traité et approuvé pour l'utilisation à l'extérieur. Construisez un cadre de 2,38 m x 4,52 m (93 1/2" x 178") (dimensions extérieures). Vous pouvez aussi utiliser le contreplaqué comme une surface plate pendant l'assemblage de ce cadre.

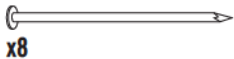

x8

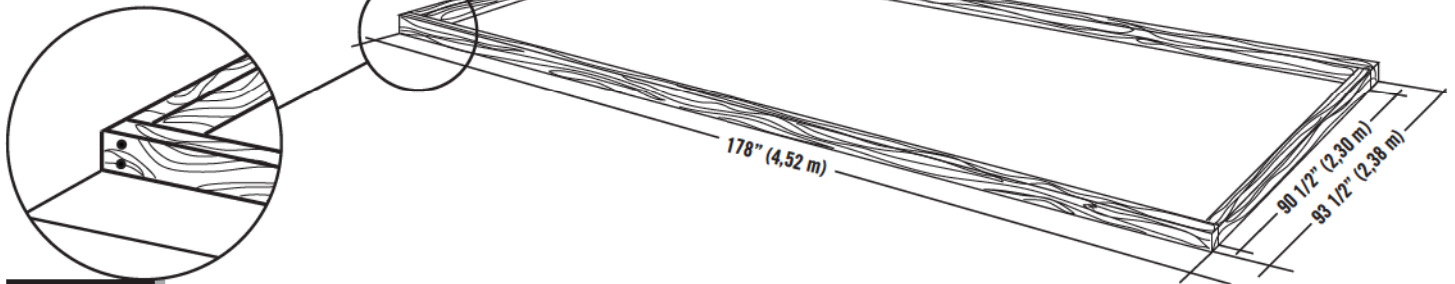

1.2.2

- To ensure studs are in the correct location for nailing plywood in the next step, start measuring from the corner 16" (40,1 cm), and then measure from center to center.
- Para asegurarse que los montantes están en las ubicaciones correctas para el contrachapado en el paso siguiente, comience a medir desde el borde del montante hasta el centro del próximo montante 40,1 cm (16"). Luego, tome la medida de centro a centro en los montantes restantes.
- Pour être sûr d'avoir assez de montant pour clouer le contreplaqué dans la prochaine étape, commencez à mesurer à partir de cette montant 40,1 cm (16") vers le centre du deuxième montant. Ensuite, mesurez de centre à centre pour les montants restants.



x44

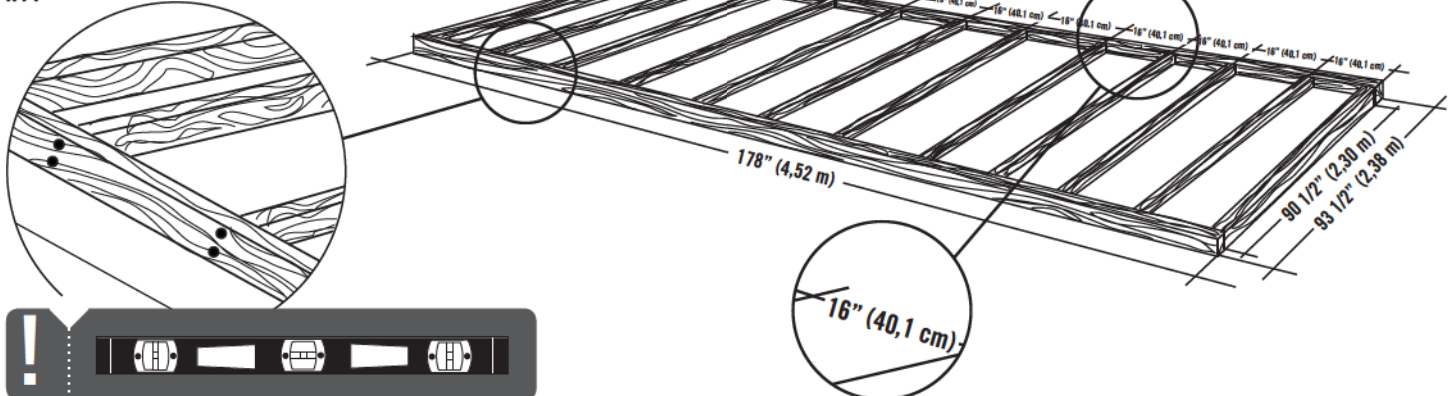

► SECTION 1 (CONTINUED) / SECCIÓN 1 (CONTINUACIÓN) / SECTION 1 (SUITE)

TOOLS, PARTS, AND HARDWARE REQUIRED / INSTRUMENTAL, PIEZAS, Y HERRAJE REQUERIDOS / OUTILS, PIÈCES, ET QUINCAILLERIE REQUIS

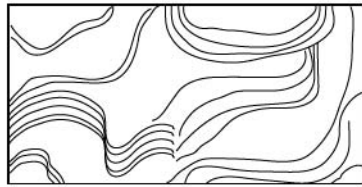

48" x 93 1/2" x 3/4"
(1,22 m x 2,38 m x 19,1 mm) (x3)



34" x 93 1/2" x 3/4"
(86,4 cm x 2,38 m x 19,1 mm) (x1)

8d 1 1/2" (8d 3,81 cm) (x84)

1.2.3

- Square the frame, measuring from corner to corner. **Measurement A & B should be about the same length.**
- Cuadre el armazón midiendo de esquina a esquina. **La medida «A» y «B» deben ser aproximadamente el mismo largo.**
- Carrez le cadre en mesurant d'angle à angle. **La mesure « A » et « B » doivent être à peu près la même longueur.**

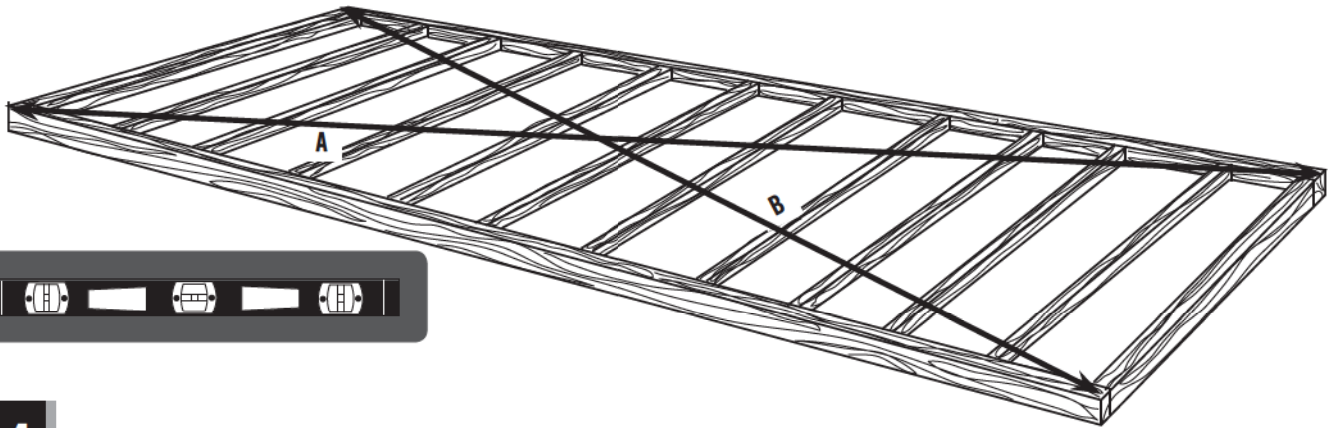

1.2.4

- Using nails, fasten the plywood to the frame. Then, drill 5/16" holes for drainage.
- Usando unos clavos, sujete el contrachapado al armazón. Entonces, taladre agujeros de 8 mm para el drenaje.
- En utilisant des clous, attachez bien le contreplaqué au cadre. Ensuite, percez des trous de 8 mm pour le drainage.

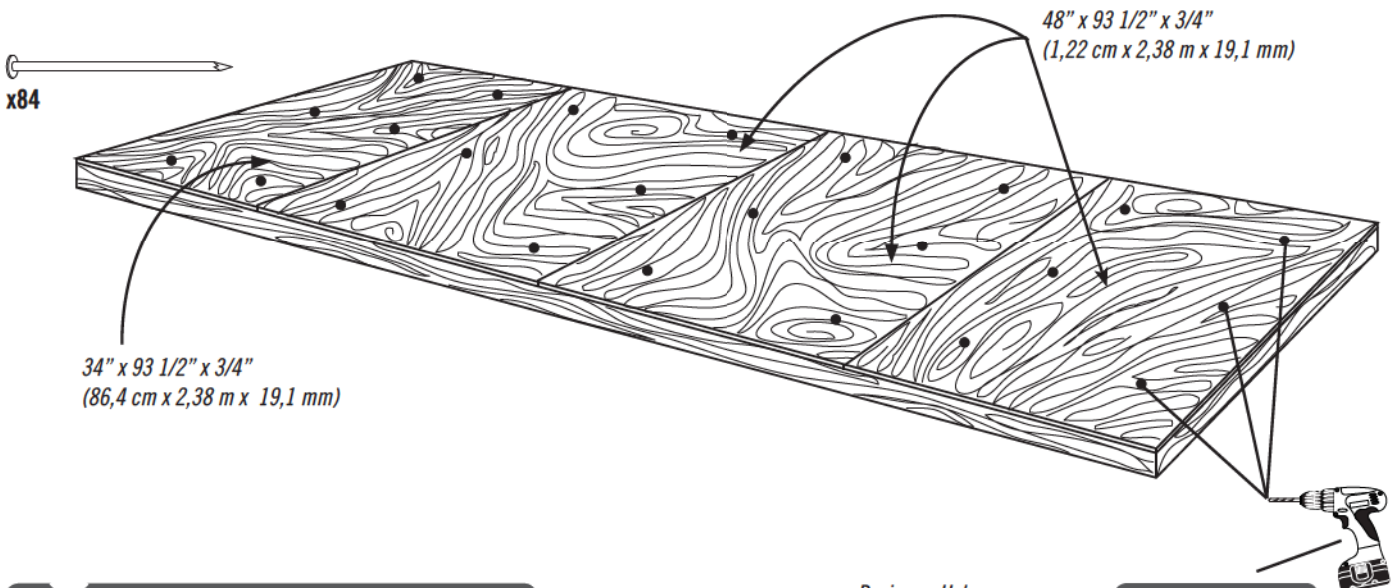

Drainage Holes
Agujeros para desagüe
Trous de drainage

2

TRUSS ASSEMBLY / ENSAMBLE DE LAS CERCHAS / ASSEMBLAGE DES FERMES



HARDWARE REQUIRED / HERRAJE REQUERIDO / QUINCAILLERIE REQUISE

Hardware Bag / Bolsa de herraje / Sac de quincaillerie



DTK (x20)



ADJ (x10)

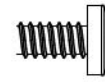

ADY (x20)



ADK (x40)

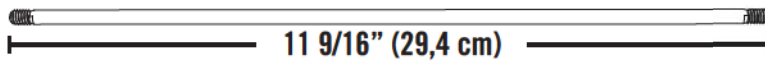

ADH (x5)

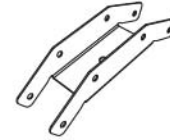

AIP (x5)



PARTS REQUIRED / PIEZAS REQUERIDAS / PIÈCES REQUISES

Metal Parts / Piezas de metal / Pièces en métal

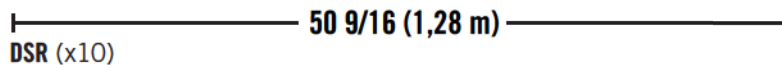

DSR (x10)

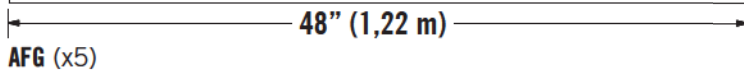
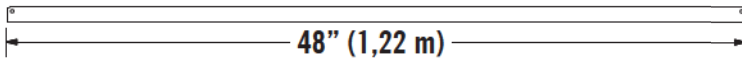

AFG (x5)

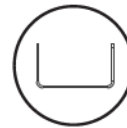

TOOLS REQUIRED / INSTRUMENTAL REQUERIDO / OUTILS REQUIS



7/16" (11 mm) (x2)



3/8" (10 mm)



3/8" (10 mm)

► SECTION 2 (CONTINUED) / SECCIÓN 2 (CONTINUACIÓN) / SECTION 2 (SUITE)

TOOLS AND HARDWARE REQUIRED / INSTRUMENTAL Y HERRAJE REQUERIDOS / OUTILS ET QUINCAILLERIE REQUIS

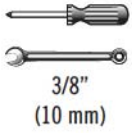

- If you have trouble with this section, follow the code below to view a video on how to assemble these Trusses.
- Si tiene problemas con esta sección, siga el código debajo para ver un video sobre el ensamble de estas Cerchas.
- Si vous avez des problèmes avec cette section, suivez le code en bas pour voir un vidéo sur l'assemblage de ces Fermes.

2.1

- Slide a **Connector (AIP)** onto the ends of two **Truss Gutter Channels (DSR)** as shown.
- Deslice un **Connector (AIP)** en los extremos de los **Canalones de la cercha (DRS)** como se muestra.
- Glissez un **Raccord (AIP)** sur les extrémités des **Canaux de gouttière (DSR)** comme illustré.

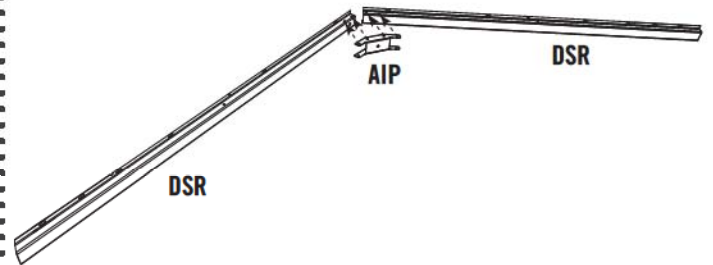

2.2

- Attach the **Connector** using the hardware indicated. **Do not overtighten the Cap Nuts.**
- Sujete el **Connector (AIP)** usando el herraje indicado. **No apriete demasiado las Tuercas ciegas.**
- Attachez le **Raccord (AIP)** à l'aide des accessoires indiqués. **Ne pas serrer excessivement les Écrous à chape.**

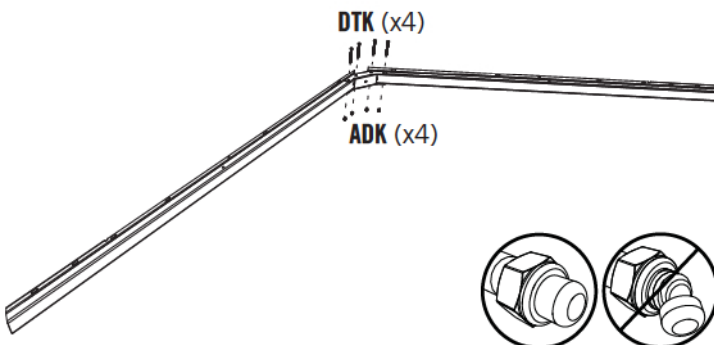

2.3

- Slide a **Large Truss Brace (AFG)** onto the Truss Gutter Channels as shown, and align the holes.
- Deslice un **Soporte grande de la cercha (AFG)** sobre los Canalones de la cercha como se muestra, y alinee los agujeros.
- Glissez un **Support grand de la ferme (AFG)** sur les Canaux de gouttière comme illustré, et alignez les trous.

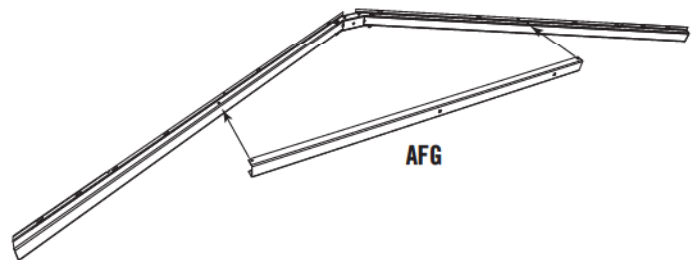

► SECTION 2 (CONTINUED) / SECCIÓN 2 (CONTINUACIÓN) / SECTION 2 (SUITE)

TOOLS AND HARDWARE REQUIRED / INSTRUMENTAL Y HERRAJE REQUERIDOS / OUTILS ET QUINCAILLERIE REQUIS



3/8"
(10 mm)

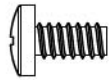

ADY (x20)



ADK (x20)

2.4

- Attach the Large Truss Brace using the hardware included. **Do not overtighten the Cap Nuts.**
- Sujete el Soporte grande de la cercha usando el herraje incluido. **No apriete demasiado las Tuercas ciegas.**
- Attachez le Support grand de la ferme à l'aide de la quincaillerie incluse. **Ne pas serrer excessivement les Écrous à chape.**

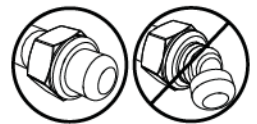
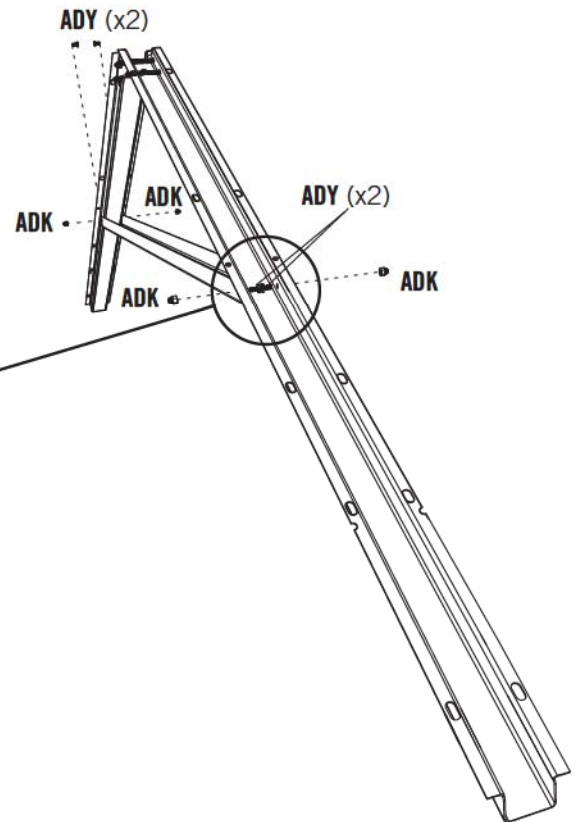
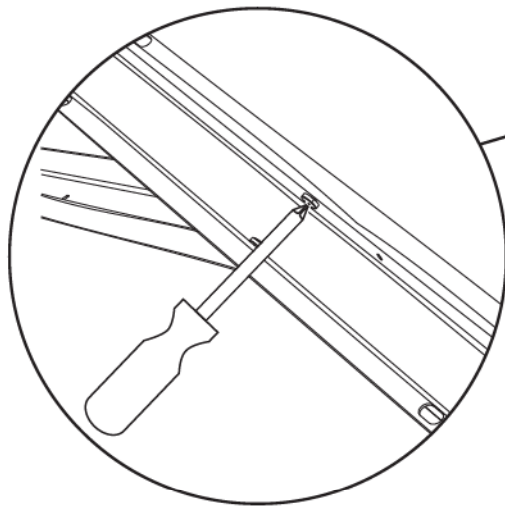

► SECTION 2 (CONTINUED) / SECCIÓN 2 (CONTINUACIÓN) / SECTION 2 (SUITE)

TOOLS AND HARDWARE REQUIRED / INSTRUMENTAL Y HERRAJE REQUERIDOS / OUTILS ET QUINCAILLERIE REQUIS



7/16" (x2)
(11 mm) (x2)



ADJ (x10)

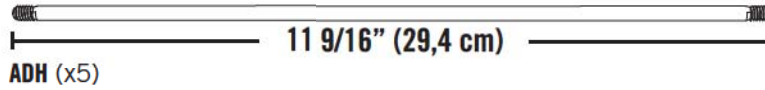

2.5

- Slide a **Truss Rod (ADH)** through the holes in the Large Truss Brace and Connector. Secure with two **Cap Nuts (ADJ)**. **Do not overtighten the Nuts.**
- Deslice una **Varilla (ADH)** a través de los agujeros en el Soporte grande y el Conector. Sujétela con dos **Tuercas ciegas (ADJ)**. **No apriete demasiado las Tuercas.**
- Glissez une **Tige (ADH)** à travers les trous dans le Grand Support et le Raccord. Attachez-la bien à l'aide de deux **Écrous à chape (ADJ)**. **Ne pas serrer excessivement les Écrous.**

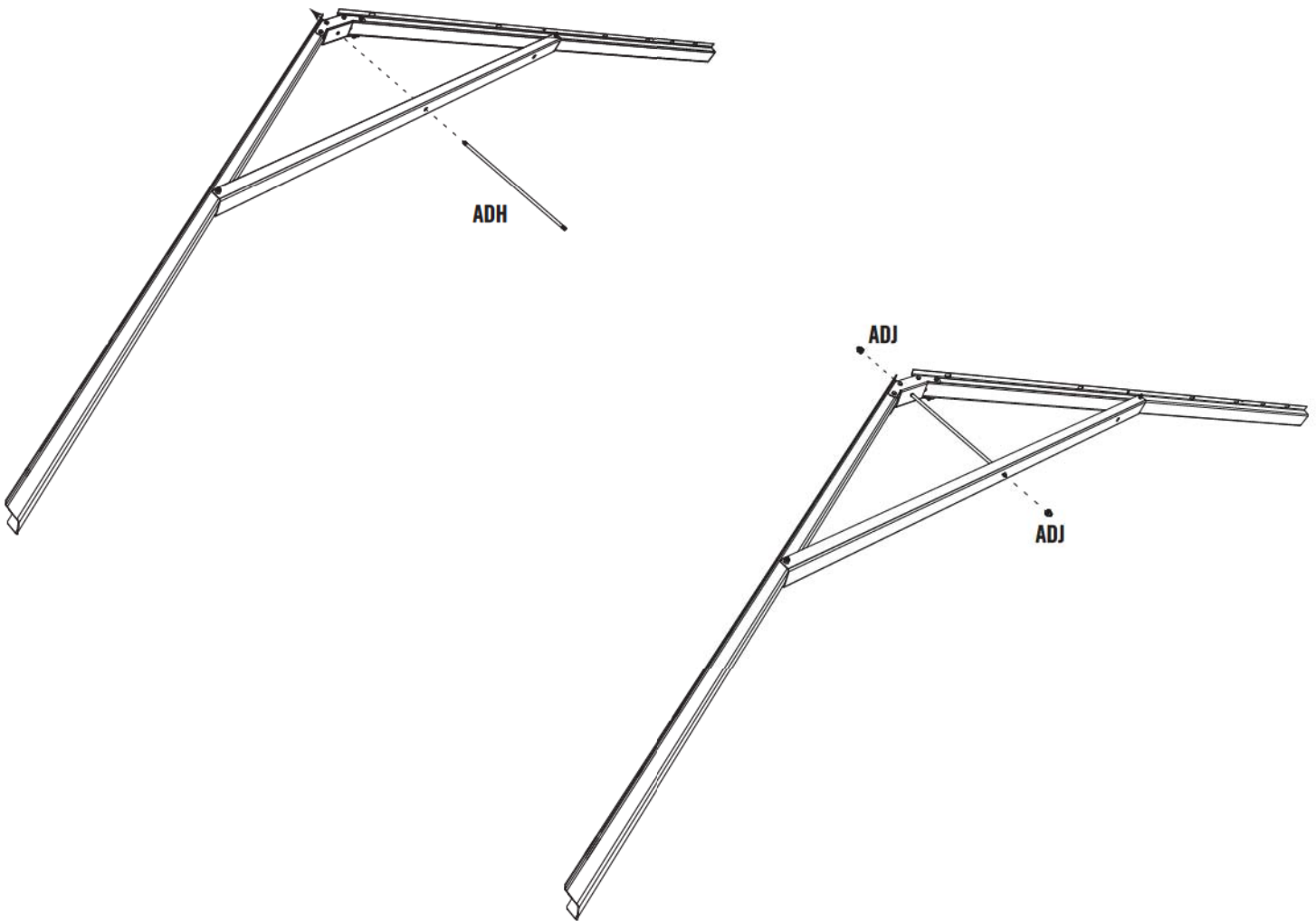

► SECTION 2 (CONTINUED) / SECCIÓN 2 (CONTINUACIÓN) / SECTION 2 (SUITE)

TOOLS AND HARDWARE REQUIRED / INSTRUMENTAL Y HERRAJE REQUERIDOS / OUTILS ET QUINCAILLERIE REQUIS



2.6

- Repeat steps 2.1–2.5 four times.
- Repita los pasos 2.1–2.5 cuatro veces.
- Répétez les étapes 2.1 – 2.5 quatre fois.

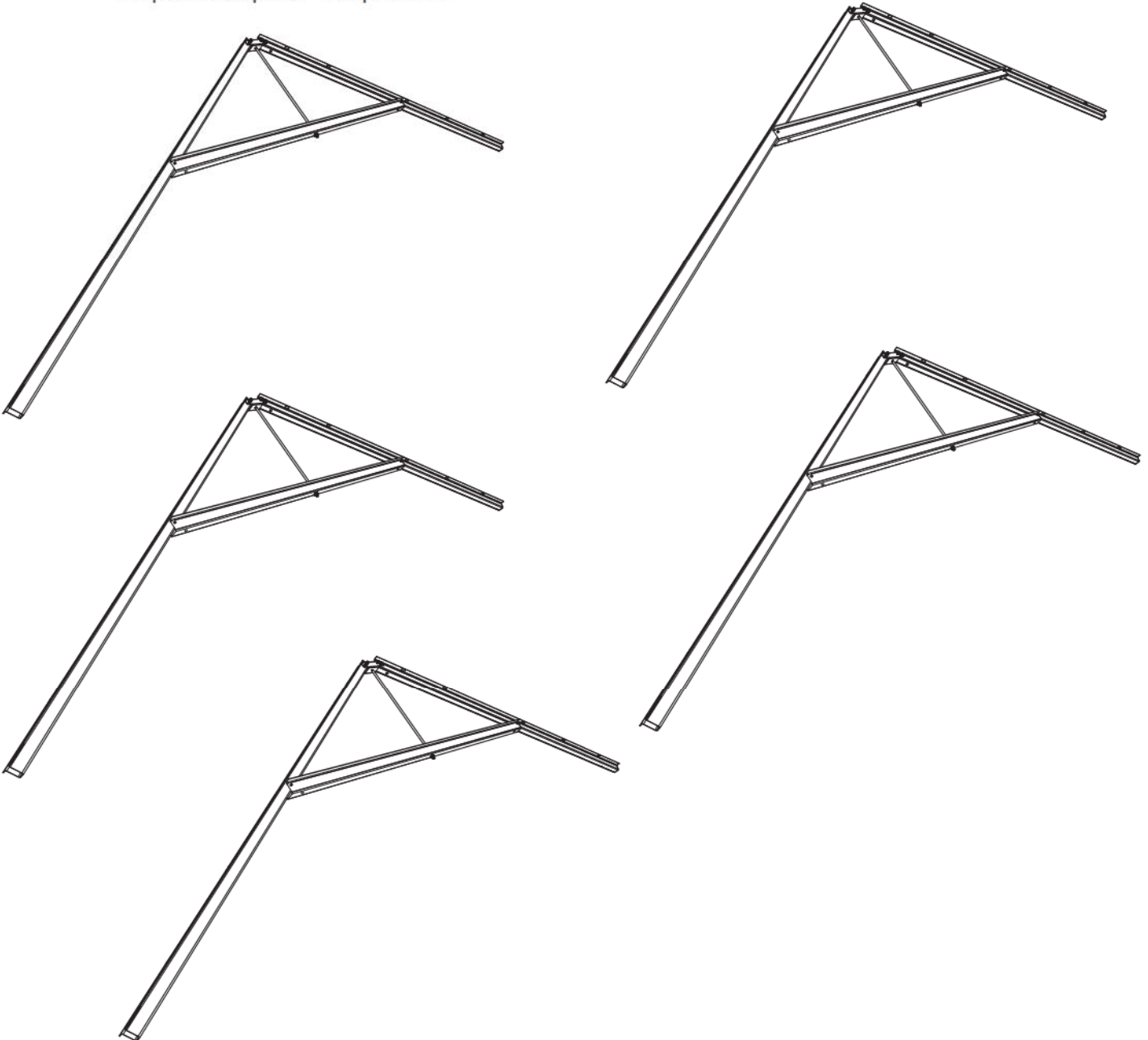

3

GABLE ASSEMBLY / ENSAMBLE DE LAS FACHADAS / ASSEMBLAGE DES PIGNONS



HARDWARE REQUIRED / HERRAJE REQUERIDO / QUINCAILLERIE REQUISE

Hardware Bag / Bolsa de herraje / Sac de quincaillerie

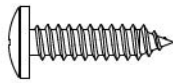

ADW (x10)

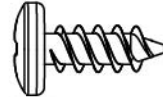

ADZ (x8)

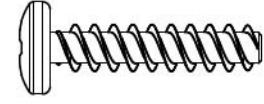

ADV (x12)



AHS (x4)

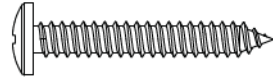

ACB (x2)



AEE (x10)

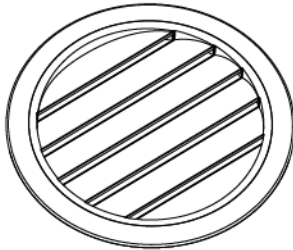

AGP (x2)

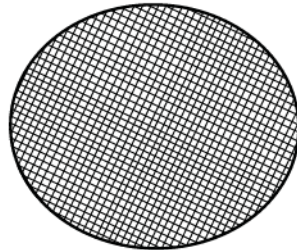

AIQ (x2)



PARTS REQUIRED / PIEZAS REQUERIDAS / PIÈCES REQUISES

Metal Part / Pieza de metal / Pièce en métal

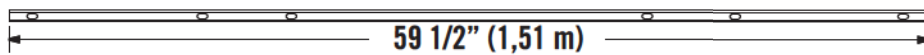

AFE (x1)

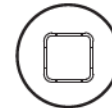

Plastic Parts / Piezas de plástico / Pièces en plastique

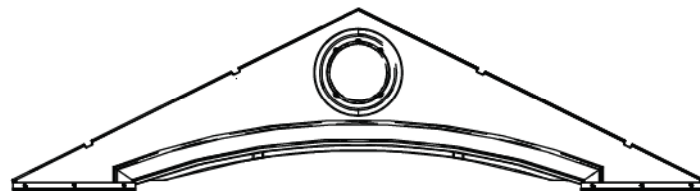

AGF (x1)

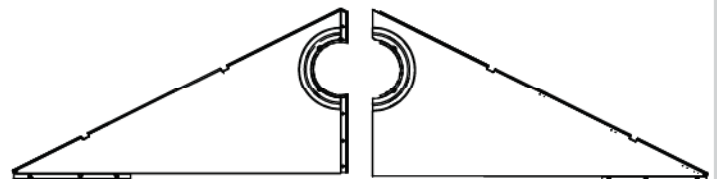

AGI (x1)

AGH (x1)



TOOLS REQUIRED / INSTRUMENTAL REQUERIDO / OUTILS REQUIS



► SECTION 3 (CONTINUED) / SECCIÓN 3 (CONTINUACIÓN) / SECTION 3 (SUITE)

TOOLS AND HARDWARE REQUIRED / INSTRUMENTAL Y HERRAJE REQUERIDOS / OUTILS ET QUINCAILLERIE REQUIS

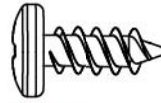

ADZ (x4)



- If you have trouble with this section, follow the code below to view a video on how to assemble these Gables.
- Si tiene problemas con esta sección, siga el código debajo para ver un video sobre el ensamble de estas Fachadas.
- Si vous avez des problèmes avec cette section, suivez le code en bas pour voir un vidéo sur l'assemblage de ces Pignons.

3.1

- Align the holes in the **Left (AGH)** and **Right (AGI)** Rear Gable Halves.
- Alinee los agujeros en las **Fachadas traseras izquierda (AGH)** y **derecha (AGI)**.
- Aligned les trous dans les **Pignons gauche (AGH)** et **droite (AGI)**.

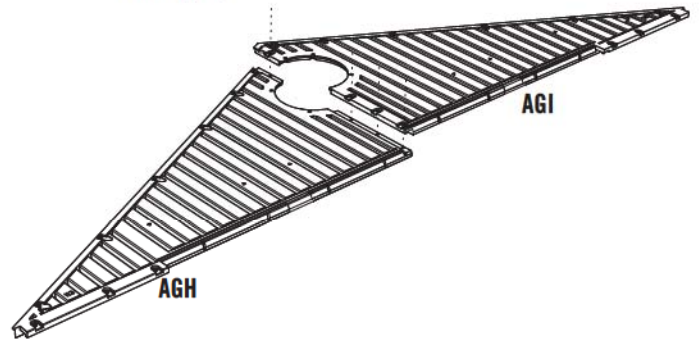

3.2

- Secure the two Gable Halves with four (4) **Screws (ADZ)**.
- Sujete el uno al otro usando cuatro (4) **Tornillos (ADZ)**.
- Attachez l'un à l'autre à l'aide de quatre (4) **Vis (ADZ)**.

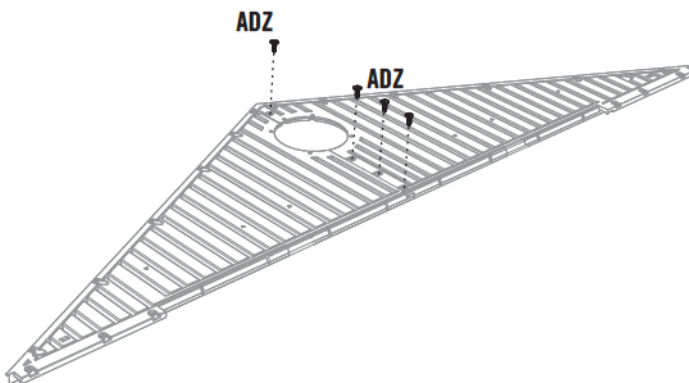

3.3

- Place the **Screen (AIQ)** over the **Vent (AGP)** and align the five holes in the Vent with those in the Gable.
- Coloque el **Mosquitero (AIQ)** sobre la **Rejilla de ventilación (AGP)** y alinee los agujeros en la Rejilla con los de la Fachada.
- Mettez la **Moustiquaire (AIQ)** sur l'**Évent (AGP)**, et alignez les cinq trous dans l'Évent avec ceux du Toit à pignon.

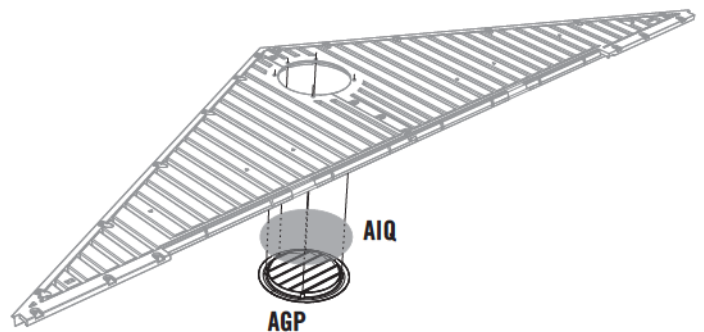

► SECTION 3 (CONTINUED) / SECCIÓN 3 (CONTINUACIÓN) / SECTION 3 (SUITE)

TOOLS AND HARDWARE REQUIRED / INSTRUMENTAL Y HERRAJE REQUERIDOS / OUTILS ET QUINCAILLERIE REQUIS

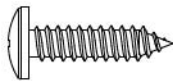

ADW (x10)



AEE (x10)



AHS (x2)

3.4

- Secure with the hardware included.
- Sujételos usando el herraje incluido.
- Attachez-les à l'aide de la quincaillerie incluse.

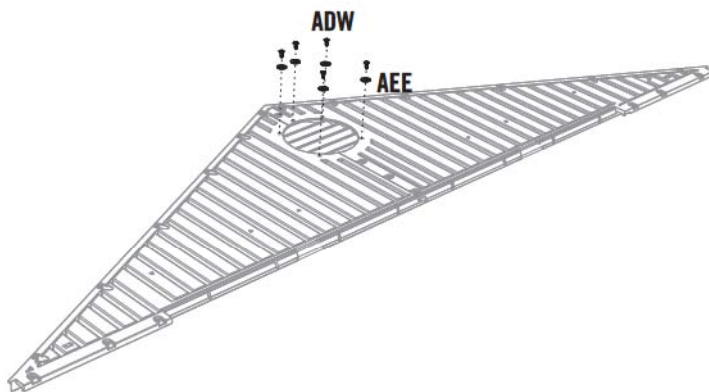

3.5

- Place the **Screen (AIQ)** over the **Vent (AGP)** and align the five holes in the Vent with those in the **Entry Gable (AGF)**.
- Coloque el **Mosquitero (AIQ)** sobre la **Rejilla de ventilación (AGP)** y alinee los agujeros en la Rejilla con los de la **Fachada de entrada (AGF)**.
- Mettez la **Moustiquaire (AIQ)** sur l'**Évent (AGP)**, et alignez les cinq trous dans l'Évent avec ceux du **Pignon d'entrée (AGF)**.

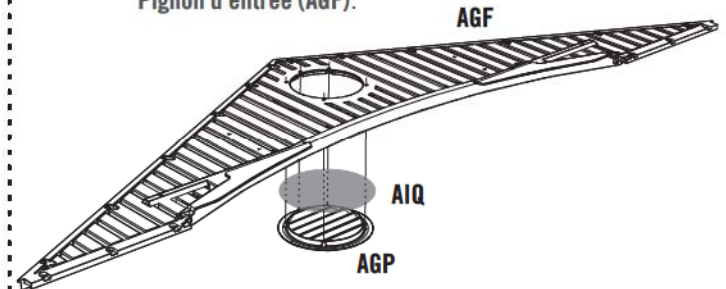

3.6

- Secure with the hardware included.
- Sujételos usando el herraje incluido.
- Attachez-les à l'aide de la quincaillerie incluse.

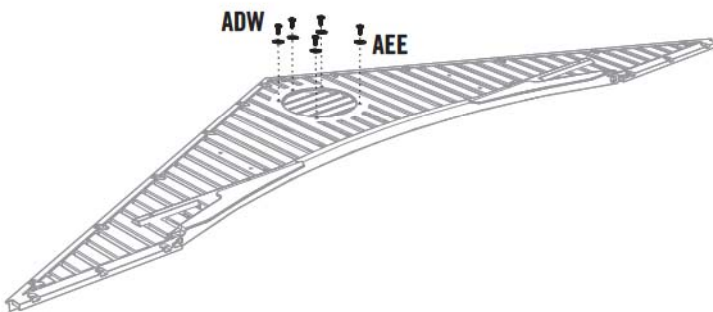

3.7

- Insert an **End Cap (AHS)** into each end of the **Header (AFE)**.
- Inserte un **Tapón (AHS)** en los dos extremos del **Dintel (AFE)**.
- Insérez un **Capuchon (AHS)** dans chaque extrémité du **Linteau (AFE)**.

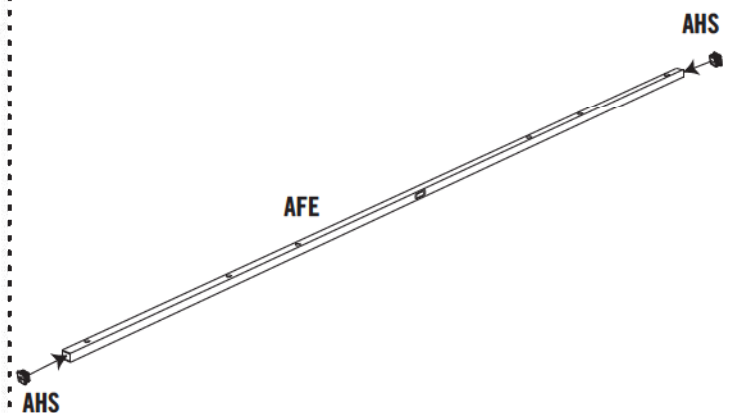

► SECTION 3 (CONTINUED) / SECCIÓN 3 (CONTINUACIÓN) / SECTION 3 (SUITE)

TOOLS AND HARDWARE REQUIRED / INSTRUMENTAL Y HERRAJE REQUERIDOS / OUTILS ET QUINCAILLERIE REQUIS

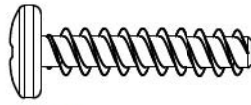

ADV (x6)

3.8

- Align the holes in the Header with those in the Gable.
- Alinee los agujeros en el Dintel con ellos en la Fachada.
- Alignez les trous dans le Linteau avec ceux du Pignon.



Note: The flat holes face away from the Gable.

Nota: Los agujeros planos dan hacia afuera.

Note : Les trous plats doivent être face à l'écart du Pignon.

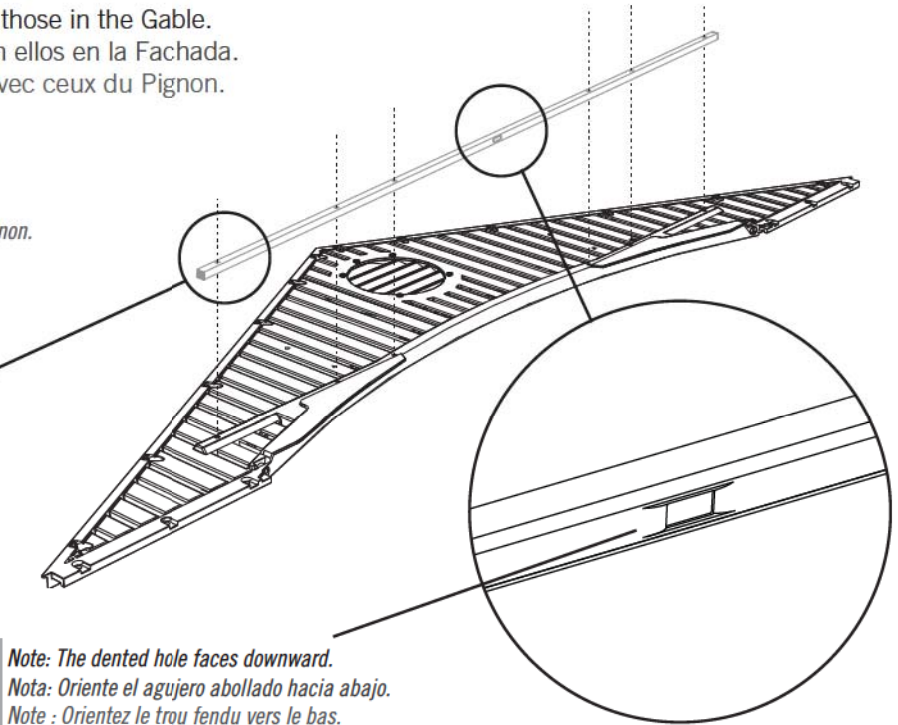
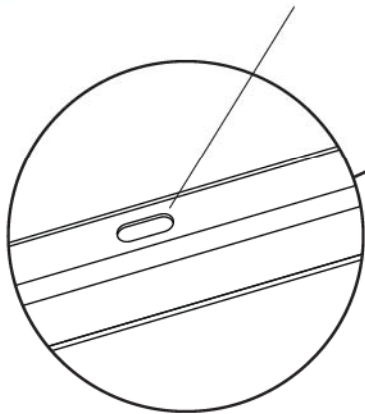

Note: The dented hole faces downward.

Nota: Oriente el agujero abollado hacia abajo.

Note : Orientez le trou fendu vers le bas.

3.9

- Secure with the hardware included.
- Sujételo usando el herraje incluido.
- Attachez-le à l'aide de la quincaillerie incluse.

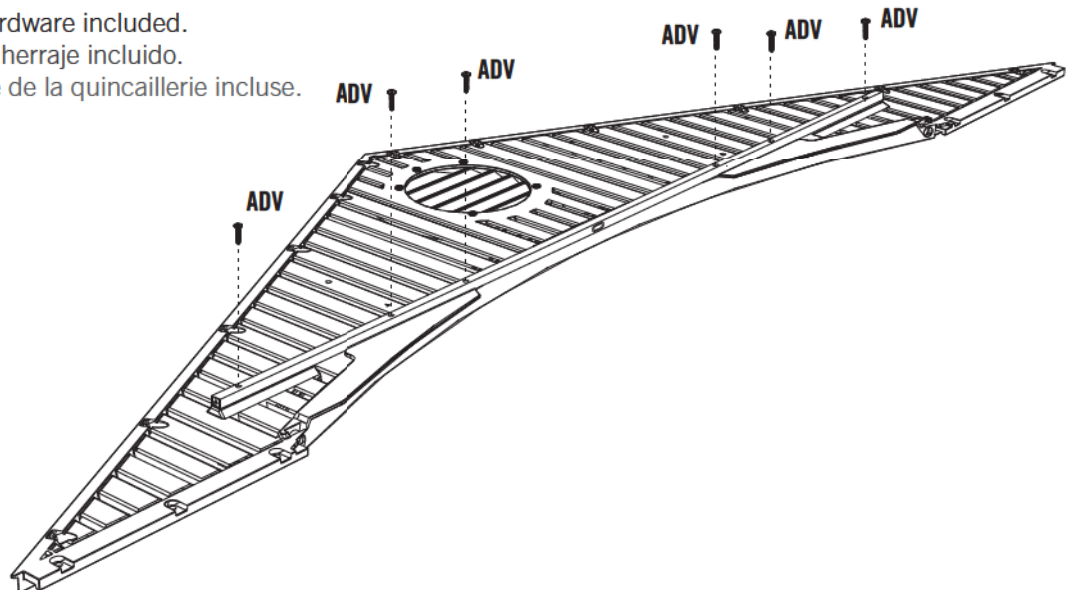

4 LEFT DOOR ASSEMBLY / ENSAMBLE DE LA PUERTA IZQUIERDA / ASSEMBLAGE DE LA PORTE GAUCHE



HARDWARE REQUIRED / HERRAJE REQUERIDO / QUINCAILLERIE REQUISE

Hardware Bags / Bolsas de herraje / Sacs de quincaillerie

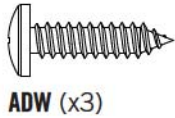

ADW (x3)

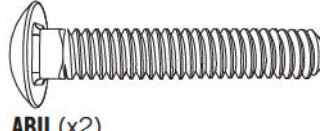

ABU (x2)



ADJ (x2)



AEE (x3)



AHM (x2)



AIA (x1)



DZG (x1)

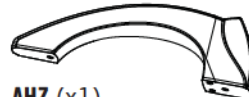

AHZ (x1)



PARTS REQUIRED / PIEZAS REQUERIDAS / PIÈCES REQUISES

Metal Parts / Piezas de metal / Pièces en métal

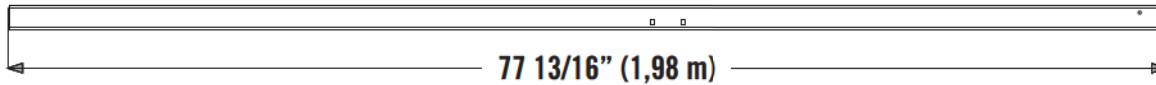

BLH (x1)

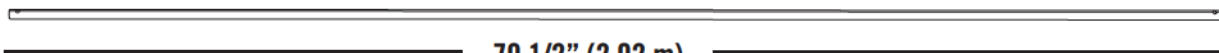
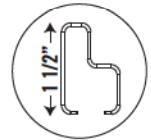

CRD (x1)



Plastic Parts / Piezas de plástico / Pièces en plastique



AGO (x1)



TOOLS REQUIRED / INSTRUMENTAL REQUERIDO / OUTILS REQUIS



7/16" (11 mm)

► SECTION 4 (CONTINUED) / SECCIÓN 4 (CONTINUACIÓN) / SECTION 4 (SUITE)

TOOLS AND HARDWARE REQUIRED / INSTRUMENTAL Y HERRAJE REQUERIDOS / OUTILS ET QUINCAILLERIE REQUIS



- If you have trouble with this section, follow the code below to view a video on how to assemble the Left Door.
- Si tiene problemas con esta sección, siga el código debajo para ver un video sobre el ensamble de la Puerta izquierda.
- Si vous avez des problèmes avec cette section, suivez le code en bas pour voir un vidéo sur l'assemblage de la Porte gauche.

4.1

- Slide a Hinge Tube (CRD) down into the hole at the top of the Left Door (AGO).
- Deslice el Tubo de articulación (CRD) en el agujero a la parte superior de la Puerta izquierda (AGO).
- Glissez le Tube d'articulation (CRD) dans le trou au bord supérieur de la Porte gauche (AGO).

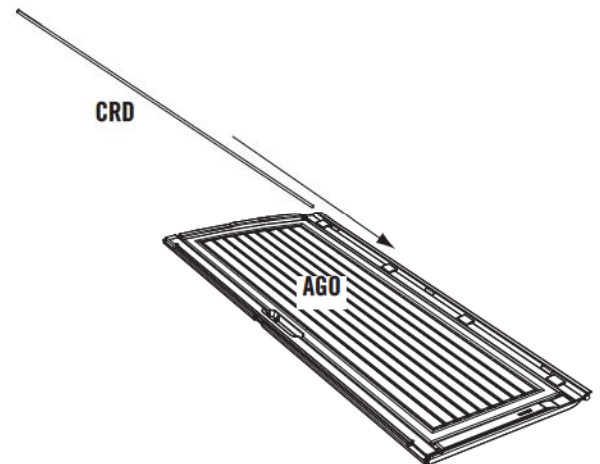

- Door Channels (BLH) are bowed by design, ensuring a tight fit when they are closed and latched, making your shed more secure. These channels are formed with a slight bend to the adjoining door edge—like parentheses facing each other: (). When the door handle is gently closed and latched, there should be a slight pressure sealing the doors and eliminating any gaps. Be sure to read the step-by-step instructions carefully to successfully install the door channels.
- Los Canales para el borde de las puertas (BLH) son curvados por diseño, asegurando un ajuste fijo cuando las puertas estén cerrados con pestillo, haciendo su caseta más segura. Estos Canales están formados con una curva ligera al borde de la puerta adyacente, como los paréntesis uno enfrente al otro: (). Cuando el picaporte esté ligeramente cerrado con pestillo, debería tener una presión ligera sellando las puertas y eliminando los espacios. Asegúrese de leer detenidamente las instrucciones paso a paso para poder instalar exitosamente los canales para el borde de las puertas.
- Les Canaux pour le bord des portes (BLH) sont courbés par dessein, en s'assurant un ajustage lorsque les portes se ferment, en faisant votre abri plus sûre. Ces Canaux sont fabriqués avec une légère courbe au bord de la porte adjacent — comme les parenthèses qui font face l'une l'autre : (). Lorsque la poignée se ferme, il devrait un légère pression en rebouchant les portes et en éliminant des ouvertures. Assurez-vous de lire avec soin les instructions étape par étape pour pouvoir installer avec succès les canaux pour le bord des portes.



BLH

► SECTION 4 (CONTINUED) / SECCIÓN 4 (CONTINUACIÓN) / SECTION 4 (SUITE)

TOOLS AND HARDWARE REQUIRED / INSTRUMENTAL Y HERRAJE REQUERIDOS / OUTILS ET QUINCAILLERIE REQUIS

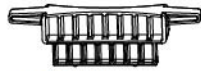

AHM (x2)

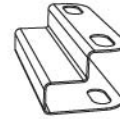

DZG (x1)

4.2

- Set the **Deadbolts (AHM)** down into the recesses at the top and bottom of the Door. Then, slide the **Door End Channel (BLH)** over the edge of the Door and the bottom of the Deadbolts as shown.
- Ponga los **Cerrojos (AHM)** en los huecos a las partes superior e inferior de la Puerta. Entonces, deslice el **Canal para el borde de la puerta (BLH)** sobre el borde de la Puerta y las partes inferiores de los Cerrojos como se muestra.
- Mettez les **Loquets à pêne dormant (AHM)** dans les espaces vides aux parties supérieure et inférieure de la Porte. Ensuite, faites glisser le **Canal de la porte (BLH)** sur le bord de la Porte et les parties inférieures des Loquets à pêne dormant comme illustré.

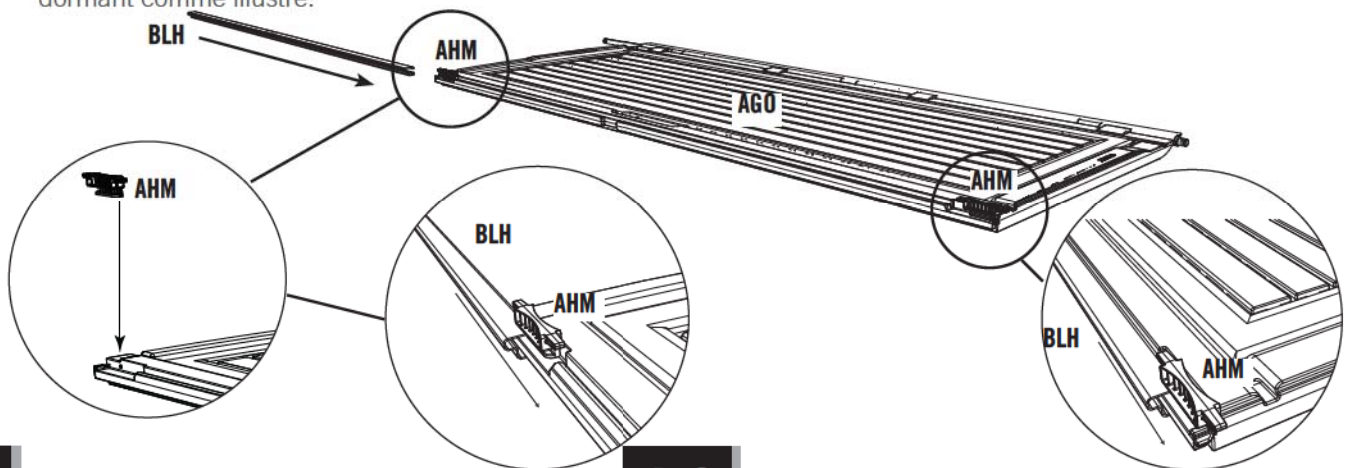

4.3

- *Note: The Deadbolts are used for locking the door. They may not move freely at first. You may need to tap them up and down a few times with a rubber mallet to work them in.*
- *Nota: Se usan los Cerrojos para cerrar la Puerta. Al principio, pueden que no se desplacen libremente. Puede que necesite darlos unos golpecitos con un mazo de goma para aflojarlos.*
- *Note : On utilise les Loquets pour fermer la Porte. Au debut, il se peut que les Loquets ne se déplaceraient librement. Vous devrez peut-être les taper légèrement à l'aide d'un maillet en caoutchouc pour les desserrer.*

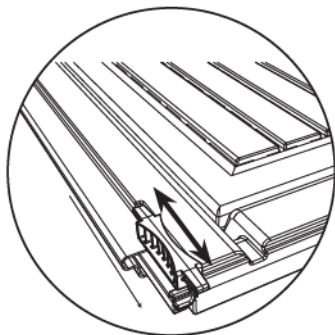

- Slide the **Strike Plate (DZG)** over the Door End Channel, and align the holes.
- Deslice la **Placa de impacto (DZG)** sobre el Canal de la puerta, y alinee los agujeros.
- Glissez la **Poignée (DZG)** sur le Canal de la porte, et alignez les trous.

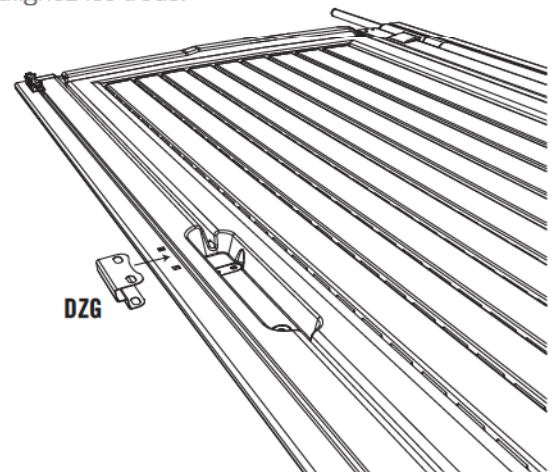

► SECTION 4 (CONTINUED) / SECCIÓN 4 (CONTINUACIÓN) / SECTION 4 (SUITE)

TOOLS AND HARDWARE REQUIRED / INSTRUMENTAL Y HERRAJE REQUERIDOS / OUTILS ET QUINCAILLERIE REQUIS



7/16"
(11 mm)



ADW (x3)

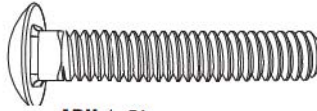

ABU (x2)



ADJ (x2)

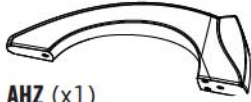

AHZ (x1)



AIA (x1)

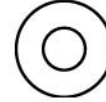

AEE (x3)

4.4

- Attach the **Door Latch (AIA)** to the Door using the hardware included. **Do not overtighten.**
- Sujete la **Placa de cierre (AIA)** a la Puerta usando el herraje incluido. **No apriete demasiado.**
- Attachez le **Loquet (AIA)** à la Porte à l'aide de la quincaillerie incluse. **Ne pas trop serrer.**

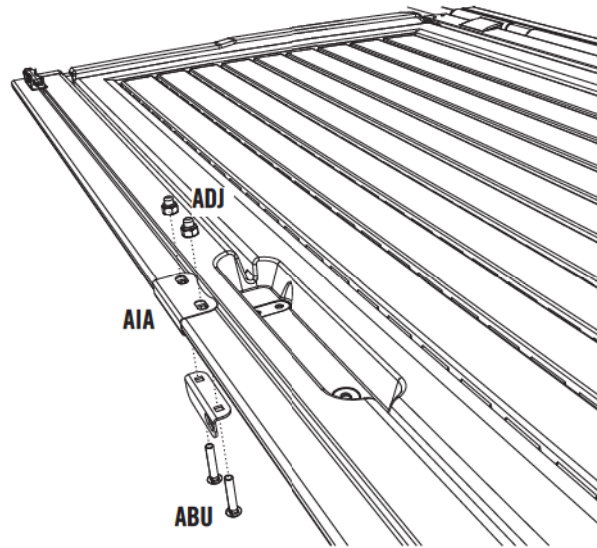

4.5

- Attach the **Handle (AHZ)** using the hardware included.
- Sujete el **Picaporte (AHZ)** usando el herraje incluido.
- Attachez la **Poignée (AHZ)** à l'aide de la quincaillerie incluse.

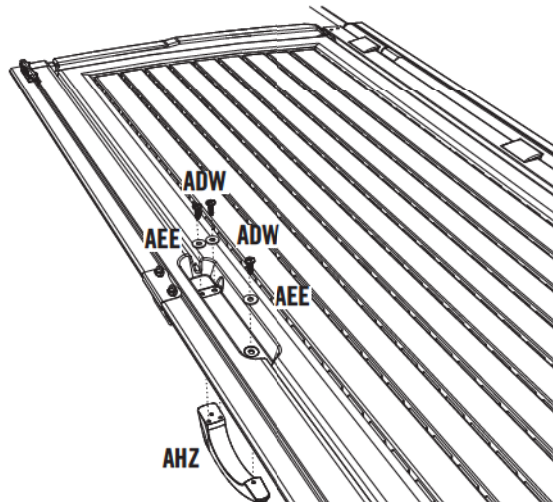

5

RIGHT DOOR ASSEMBLY / ENSAMBLE DE LA PUERTA DERECHA / ASSEMBLAGE DE LA PORTE DROITE



HARDWARE REQUIRED / HERRAJE REQUERIDO / QUINCAILLERIE REQUISE

Hardware Bag / Bolsa de herraje / Sac de quincaillerie

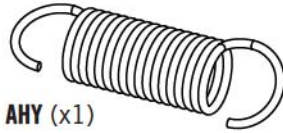

AHY (x1)

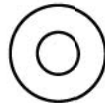

AEE (x5)



ADB (x2)

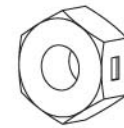

AAB (x2)



AEB (x2)

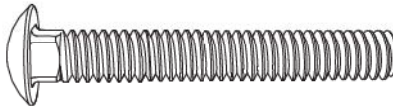

ABV (x2)

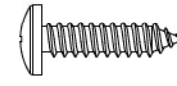

ADW (x4)

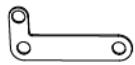

AHX (x1)

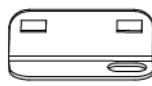

AIL (x1)



AHV (x1)

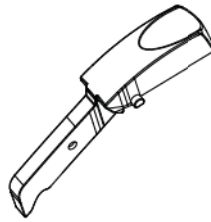

AIO (x1)



AIK (x1)

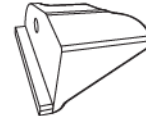

AHW (x1)



PARTS REQUIRED / PIEZAS REQUERIDAS / PIÈCES REQUISES

Metal Parts / Piezas de metal / Pièces en métal

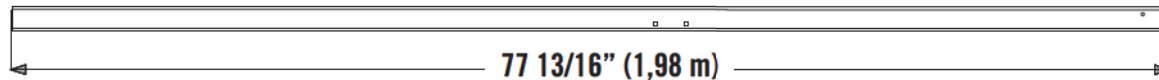

BLH (x1)

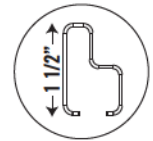

CRD (x1)



Plastic Parts / Piezas de plástico / Pièces en plastique

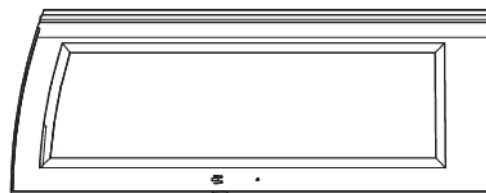

AGZ (x1)



TOOLS REQUIRED / INSTRUMENTAL REQUERIDO / OUTILS REQUIS



7/16" (11 mm)

► SECTION 5 (CONTINUED) / SECCIÓN 5 (CONTINUACIÓN) / SECTION 5 (SUITE)

TOOLS AND HARDWARE REQUIRED / INSTRUMENTAL Y HERRAJE REQUERIDOS / OUTILS ET QUINCAILLERIE REQUIS



- If you have trouble with this section, follow the code below to view a video on how to assemble the Right Door.
- Si tiene problemas con esta sección, siga el código debajo para ver un video sobre el ensamble de la Puerta derecha.
- Si vous avez des problèmes avec cette section, suivez le code en bas pour voir un vidéo sur l'assemblage de la Porte droite.

5.1

- Slide a **Hinge Tube (CRD)** down into the hole at the top of the **Right Door (AGZ)**.
- Deslice el **Tubo de articulación (CRD)** en el agujero a la parte superior de la **Puerta derecha (AGZ)**.
- Glissez le **Tube d'articulation (CRD)** dans le trou au bord supérieur de la **Porte droite (AGZ)**.

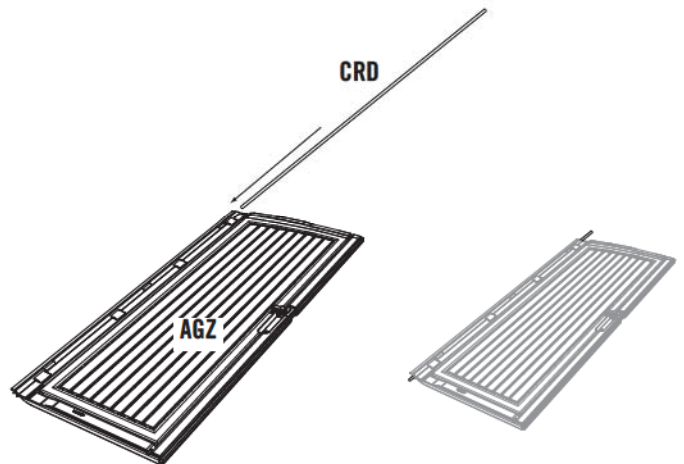

- Door Channels (BLH) are bowed by design, ensuring a tight fit when they are closed and latched, making your shed more secure. These channels are formed with a slight bend to the adjoining door edge—like parentheses facing each other: (). When the door handle is gently closed and latched, there should be a slight pressure sealing the doors and eliminating any gaps. Be sure to read the step-by-step instructions carefully to successfully install the door channels.
- Los Canales para el borde de las puertas (BLH) son curvados por diseño, asegurando un ajuste fijo cuando las puertas estén cerrados con pestillo, haciendo su caseta más segura. Estos Canales están formados con una curva ligera al borde de la puerta adyacente, como los paréntesis uno enfrente al otro: (). Cuando el picaporte esté ligeramente cerrado con pestillo, debería tener una presión ligera sellando las puertas y eliminando los espacios. Asegúrese de leer detenidamente las instrucciones paso a paso para poder instalar exitosamente los canales para el borde de las puertas.
- Les Canaux pour le bord des portes (BLH) sont courbés par dessein, en s'assurant un ajustage lorsque les portes se ferment, en faisant votre abri plus sûre. Ces Canaux sont fabriqués avec une légère courbe au bord de la porte adjacent — comme les parenthèses qui font face l'une l'autre : (). Lorsque la poignée se ferme, il devrait un légère pression en rebouchant les portes et en éliminant des ouvertures. Assurez-vous de lire avec soin les instructions étape par étape pour pouvoir installer avec succès les canaux pour le bord des portes.



BLH

► SECTION 5 (CONTINUED) / SECCIÓN 5 (CONTINUACIÓN) / SECTION 5 (SUITE)

TOOLS AND HARDWARE REQUIRED / INSTRUMENTAL Y HERRAJE REQUERIDOS / OUTILS ET QUINCAILLERIE REQUIS

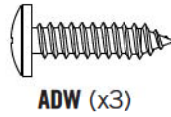
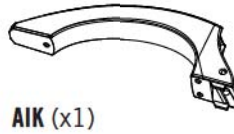
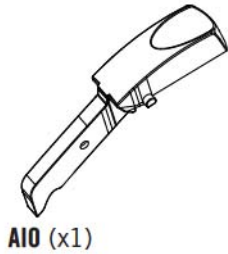

5.2

- Slide the **Door End Channel (BLH)** over the edge of the Door as shown.
- Deslice el **Canal para el borde de la puerta (BLH)** sobre el borde de la Puerta como se muestra.
- Faites glisser le **Canal de la porte (BLH)** sur le bord de la Porte comme illustré.

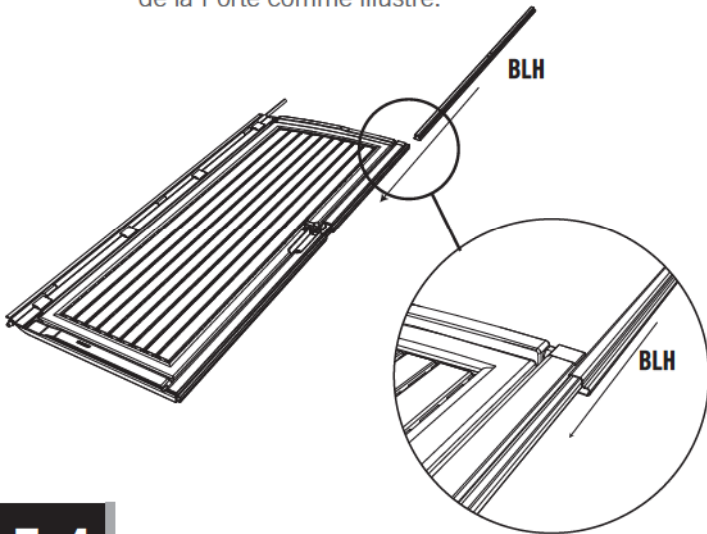

5.3

- Slide the **Thumb Lever (AIO)** down into the grooves in the **Door Handle (AIK)** until the nubs fit into the holes.
- Deslice la **Palanca de pulgar (AIO)** en las ranuras del **Picaporte (AIK)** hasta que los nudos se encajen en los agujeros.
- Glissez le **Levier poussoir (AIO)** dans les rainures de la **Poignée (AIK)** jusqu'à ce que les petites bosses se fixent dans les trous.

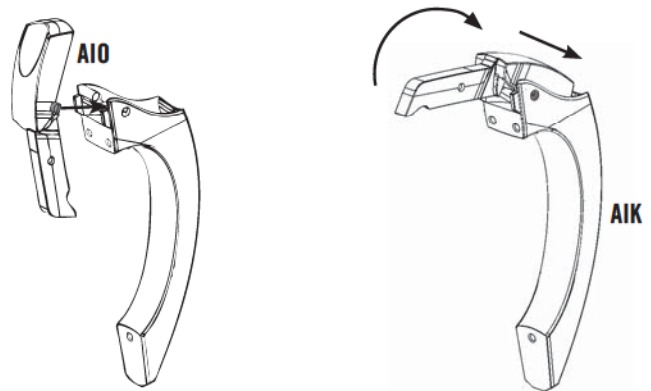

5.4

- Attach the Handle using the hardware included.
- Sujete el Picaporte usando el herraje incluido.
- Attachez la Poignée à l'aide de la quincaillerie incluse.

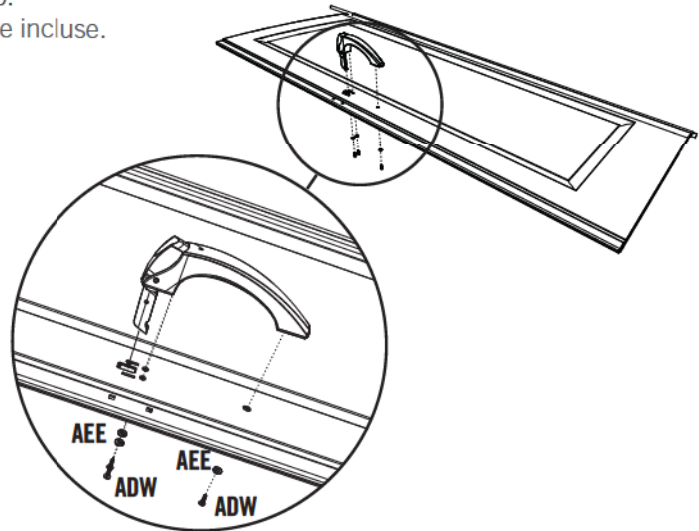

SECTION 5 (CONTINUED) / SECCIÓN 5 (CONTINUACIÓN) / SECTION 5 (SUITE)

TOOLS AND HARDWARE REQUIRED / INSTRUMENTAL Y HERRAJE REQUERIDOS / OUTILS ET QUINCAILLERIE REQUIS



7/16"
(11 mm)

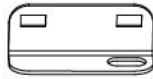

AIL (x1)

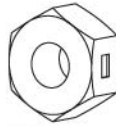

AAB (x2)

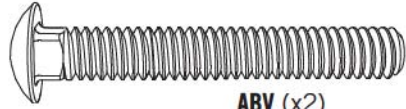

ABV (x2)

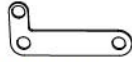

AHX (x1)



AHV (x1)



ADB (x2)

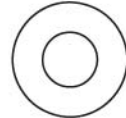

AEB (x2)

5.5

- Attach the Locking Hardware using the hardware included. **The arm of the Latch rests on top of the Thumb Lever.**
- Sujete los accesorios de cierre usando el herraje incluido. **El brazo del Pestillo se queda sobre la Palanca de pulgar.**
- Attachez les accessoires de verrouillage à l'aide de la quincaillerie incluse. **Le bras du Loquet doit rester sur le Levier poussoir.**

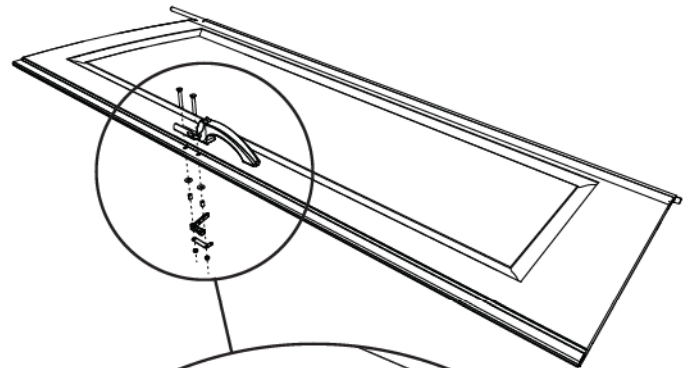

Thumb Lever
Palanca de pulgar
Lever poussoir

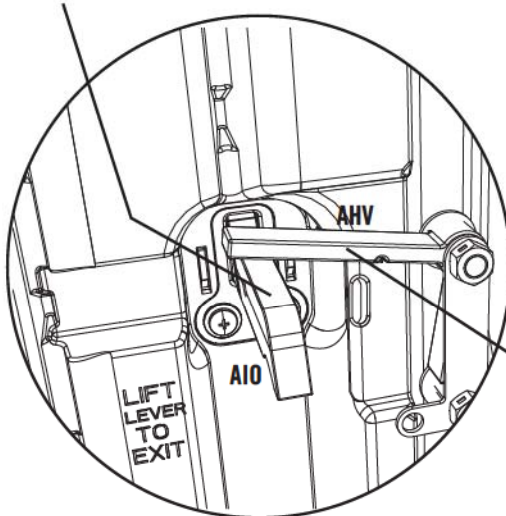

Arm of Latch
Brazo del Pestillo
Bras du Loquet

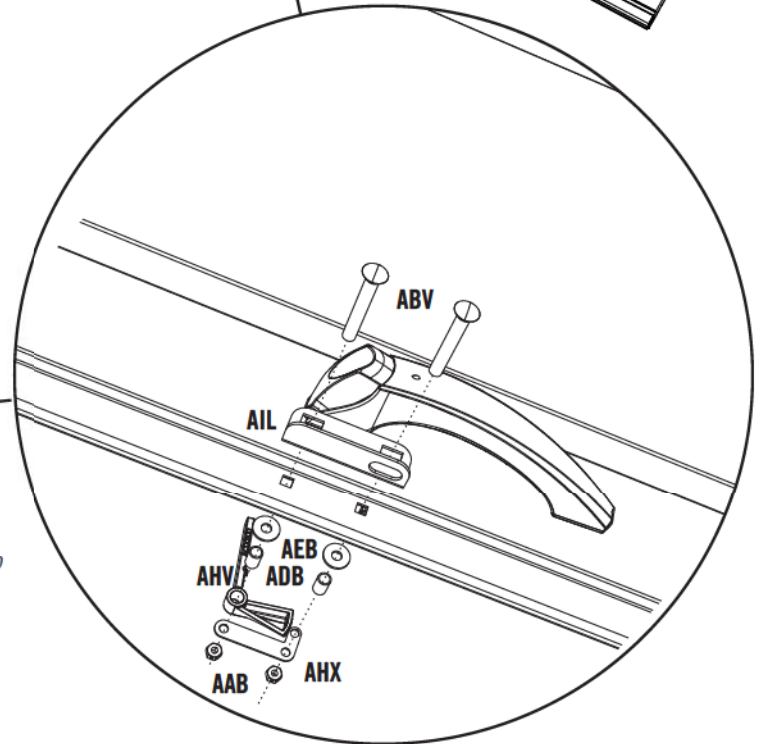

Rear of Door / Trasero de la puerta / Arrière de la porte

► SECTION 5 (CONTINUED) / SECCIÓN 5 (CONTINUACIÓN) / SECTION 5 (SUITE)

TOOLS AND HARDWARE REQUIRED / INSTRUMENTAL Y HERRAJE REQUERIDOS / OUTILS ET QUINCAILLERIE REQUIS

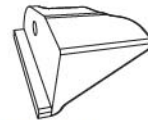
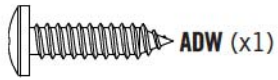
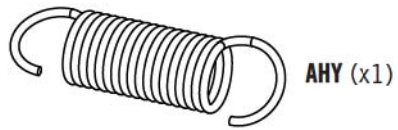

5.6

- Attach the **Bracket (AHW)** using a **Screw (ADW)**, and attach the **Spring (AHY)**.
- Sujete el **Soporte (AHW)** usando un **Tornillo (ADW)**, y sujete el **Resorte (AHY)**.
- Attachez le **Support (AHW)** à l'aide d'une **Vis (ADW)**, et attachez le **Ressort (AHY)**.

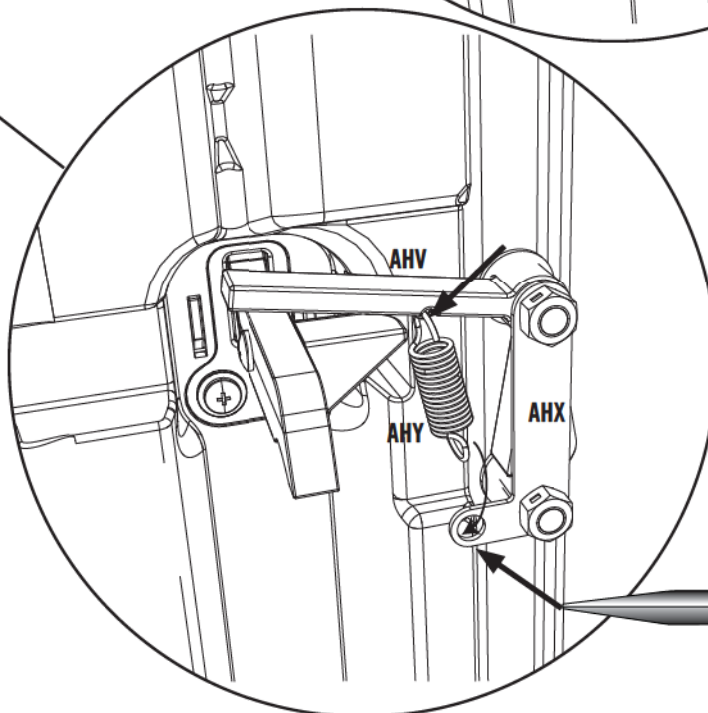
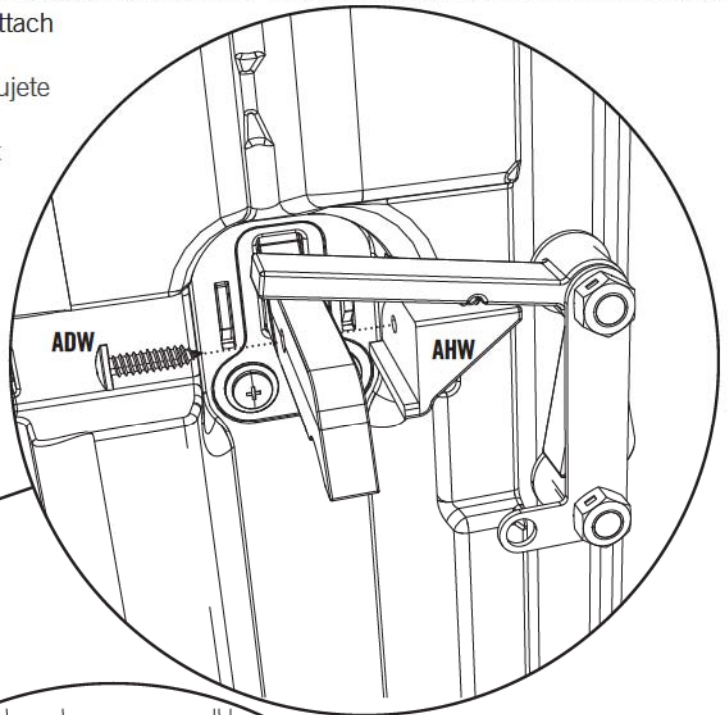
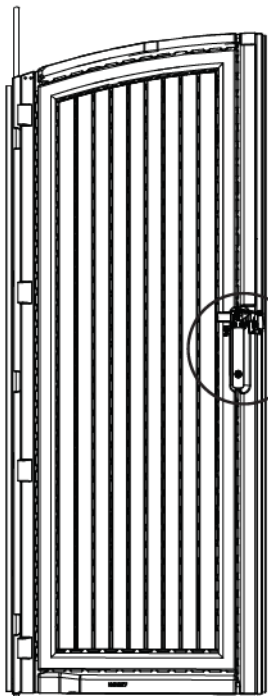

6

FLOOR ASSEMBLY / ENSAMBLE DEL PISO / ASSEMBLAGE DU PLANCHER



HARDWARE REQUIRED / HERRAJE REQUERIDO / QUINCAILLERIE REQUISE

Hardware Bag / Bolsa de herraje / Sac de quincaillerie

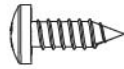

BQC (x40)



AHO (x2)



ADC (x1)



Note: These Screws do not anchor the Floor; they only hold the Panels together.

Nota: Estos Tornillos no anclan el Piso; sirven sólo para sujetar los Paneles los unos a los otros.

Note : Ces Vis n'ancrent pas le Plancher ; ils ne servent que pour attacher les Panneaux les uns aux autres.



PARTS REQUIRED / PIEZAS REQUERIDAS / PIÈCES REQUISES

Plastic Parts/ Piezas de plástico / Pièces en plastique

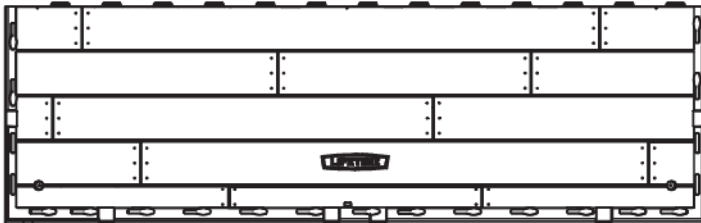

CUW (x2)



CUD (x4)



TOOLS REQUIRED / INSTRUMENTAL REQUERIDO / OUTILS REQUIS



► SECTION 6 (CONTINUED) / SECCIÓN 6 (CONTINUACIÓN) / SECTION 6 (SUITE)

TOOLS AND HARDWARE REQUIRED / INSTRUMENTAL Y HERRAJE REQUERIDOS / OUTILS ET QUINCAILLERIE REQUIS



6.1



- Hold an **Inner Floor Panel (CUD)** at an angle and slide the tabs along the edge underneath an **Outer Floor Panel (CUW)**. The tabs interlock. Lay Panel down flat.
- Coloque un **Panel de piso interior (CUD)** a un ángulo y deslice las lengüetas a lo largo del borde debajo el **Panel de piso exterior (CUW)**. Las lengüetas se entrelazan las unas con las otras. Aplane el Panel.
- Posez un **Panneau de plancher intérieur (CUD)** à un angle et glissez les languettes le long du bord au-dessus du **Panneau de plancher extérieur (CUW)**. Les languettes s'enclenchent les uns les autres. Étendez-le par terre.

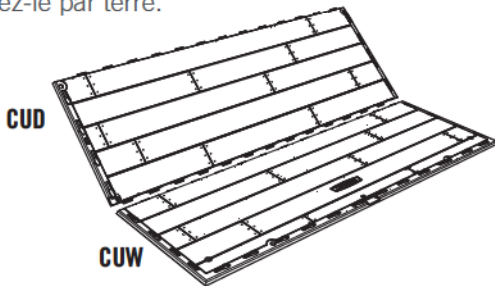

6.2

- Attach another **Inner Floor Panel (CUD)** to the first **Inner Floor Panel (CUD)**.
- Fije otro **Panel de piso interior (CUD)** al primer **Panel de piso interior (CUD)**.
- Attachez un autre **Panneau de plancher intérieur (CUD)** au premier **Panneau de plancher intérieur (CUD)**.

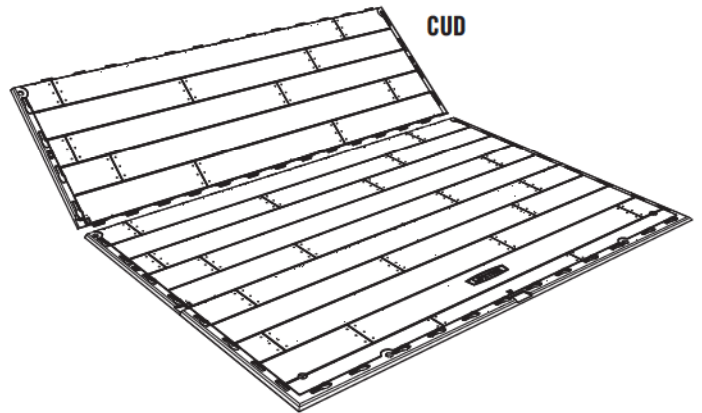

6.3

- Repeat the previous step twice.
- Repita el paso anterior dos veces.
- Répétez l'étape précédente deux fois.

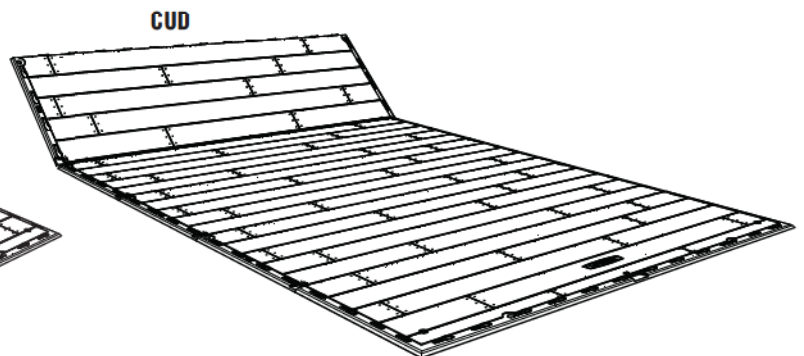
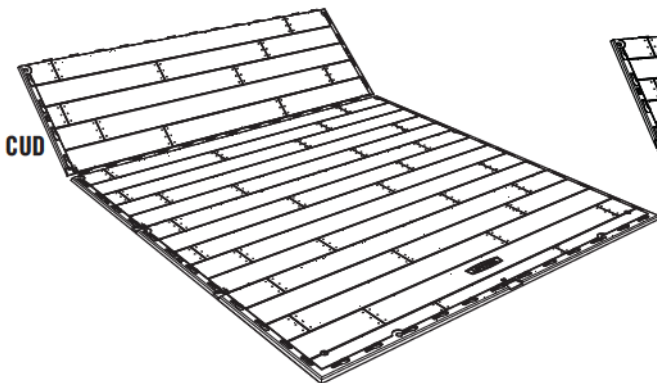

► SECTION 6 (CONTINUED) / SECCIÓN 6 (CONTINUACIÓN) / SECTION 6 (SUITE)

TOOLS AND HARDWARE REQUIRED / INSTRUMENTAL Y HERRAJE REQUERIDOS / OUTILS ET QUINCAILLERIE REQUIS



AHO (x2)

6.4

- Hold an **Outer Floor Panel (CUW)** at an angle and slide the tabs along the edge underneath the last **Inner Floor Panel (CUD)**. Lay Panel down flat.
- Coloque un **Panel de piso exterior (CUW)** a un ángulo y deslice las lenguetas a lo largo del borde debajo el último **Panel de piso interior (CUD)**. Aplane el Panel.
- Posez un **Panneau de plancher extérieur (CUW)** à un angle et glissez les languettes le long du bord au-dessus du dernier **Panneau de plancher intérieur (CUD)**. Étendez-le par terre.

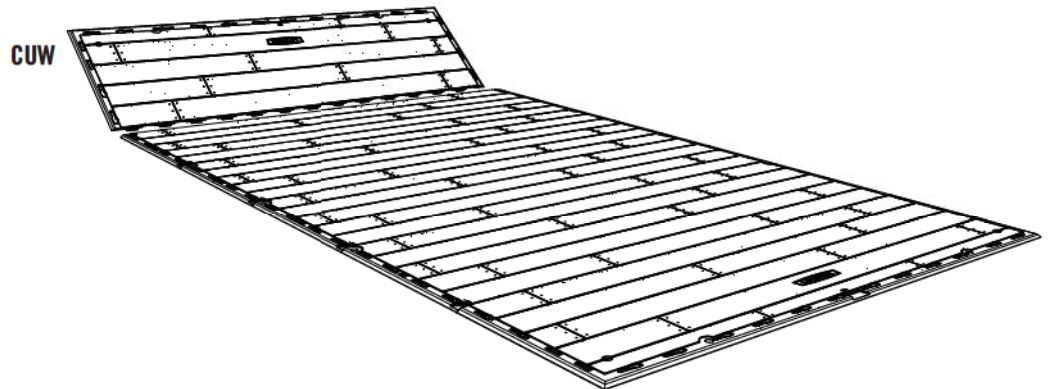

6.5

- Decide on which end you would like to install your Doors. Insert **Bushings (AHO)** through the holes in the Floor. **The slit in the Bushing should face the front of the shed.**
- Decida en cual borde le gustaría instalar las Puertas. Introduzca los **Casquillos (AHO)** a través de los agujeros en el Piso. **La rendija en el Casquillo debe dar hacia el borde delantero del cobertizo.**
- Choisissez l'extrémité où vous désiriez installer les Portes. Insérez les **Bagues (AHO)** à travers les trous dans le Plancher. **La fente dans la Bague doit donner sur le bord avant de l'abri.**

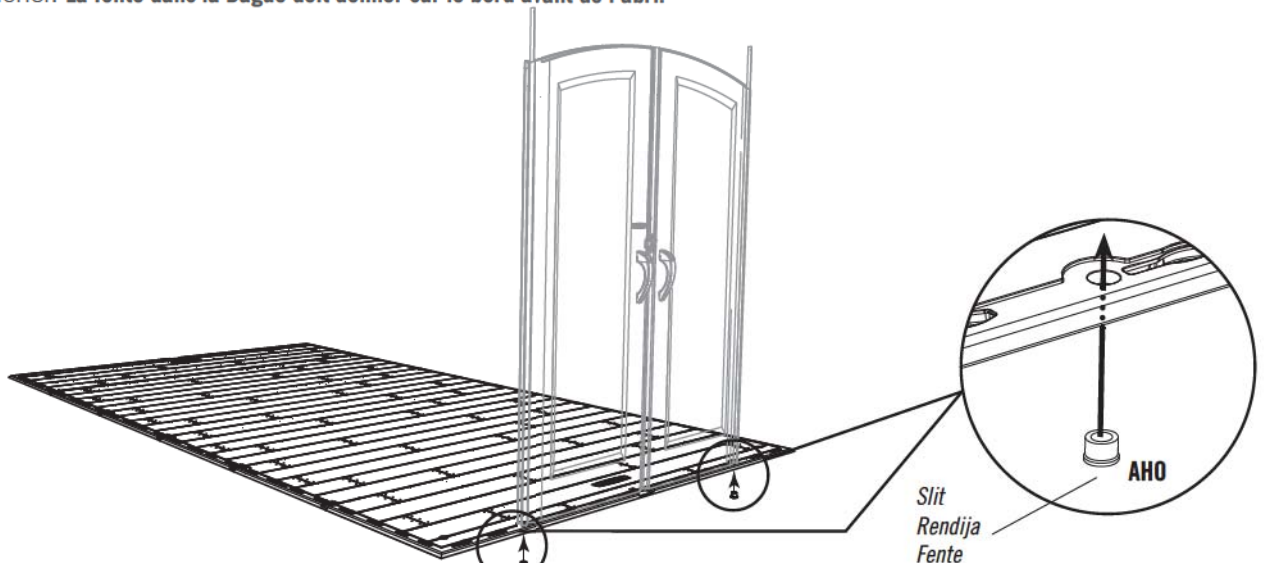

► SECTION 6 (CONTINUED) / SECCIÓN 6 (CONTINUACIÓN) / SECTION 6 (SUITE)

TOOLS AND HARDWARE REQUIRED / INSTRUMENTAL Y HERRAJE REQUERIDOS / OUTILS ET QUINCAILLERIE REQUIS

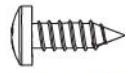

BQC (x30)

6.6

• Insert the **Screws (BQC)** through the divots in the Floor Panels and into the tabs of the adjacent Floor Panels. (The divots are near the seams of the Floor Panels.)

• Introduzca los **Tornillos (BQC)** a través de las marcas en los Paneles de piso y dentro de las lengüetas des los Paneles de piso adyacentes. (Se encuentran las marcas cerca de las juntas de los Paneles de piso.)

• Insérez les **Vis (BQC)** à travers les marques dans les Panneaux de plancher et dans les languettes du Panneaux de plancher contigu. (Les marques se trouvent près des jonctions des Panneaux de plancher.)

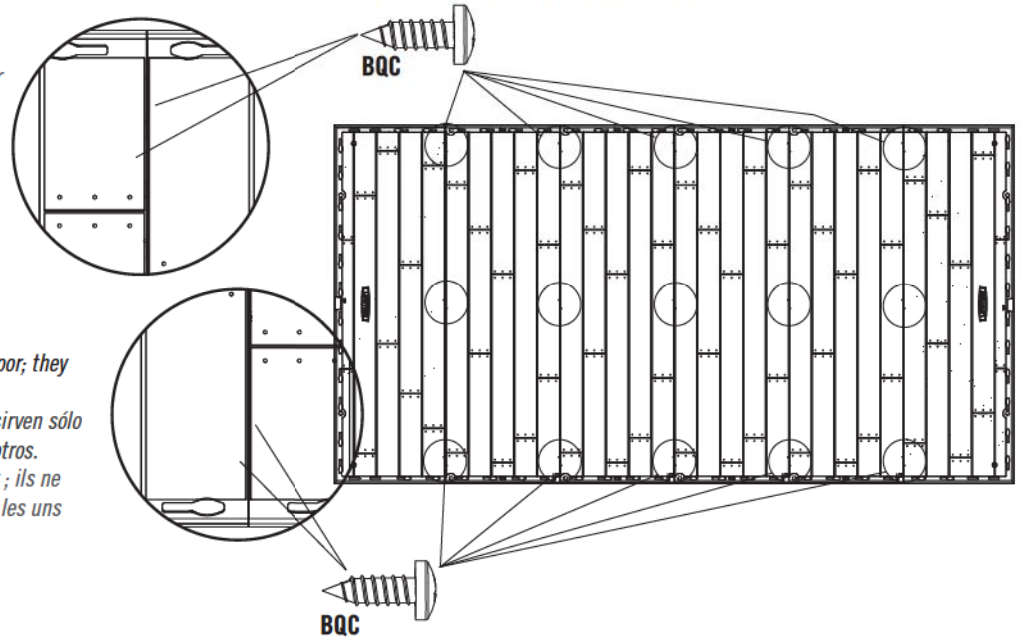

Note: These Screws do not anchor the Floor; they only hold the Panels together.

Nota: Estos Tornillos no anclan el Piso; sirven sólo para sujetar los Paneles los unos a los otros.

Note : Ces Vis n'ancrent pas le Plancher ; ils ne servent que pour attacher les Panneaux les uns aux autres.

7

WALL ASSEMBLY / ENSAMBLE DE LOS MUROS / ASSEMBLAGE DES MURS



HARDWARE REQUIRED / HERRAJE REQUERIDO / QUINCAILLERIE REQUISE

Hardware Bag / Bolsa de herraje / Sac de quincaillerie

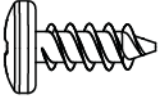

ADZ (x85)



PARTS REQUIRED / PIEZAS REQUERIDAS / PIÈCES REQUISES

Plastic Parts / Piezas de plástico / Pièces en plastique

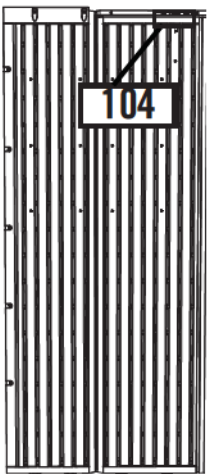

AGY (x1)

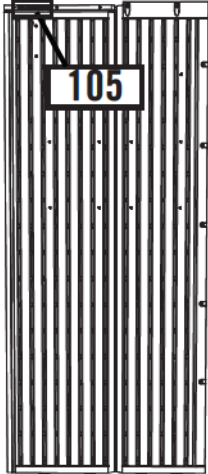

AGN (x1)

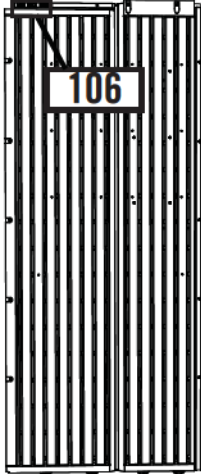

AGW (x1)

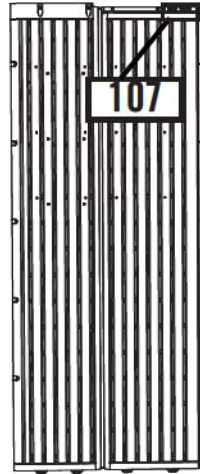

AGL (x1)



AHD (x10)



AHH (x2)



TOOLS REQUIRED / INSTRUMENTAL REQUERIDO / OUTILS REQUIS



AIW (x1)



► SECTION 7 (CONTINUED) / SECCIÓN 7 (CONTINUACIÓN) / SECTION 7 (SUITE)

TOOLS AND HARDWARE REQUIRED / INSTRUMENTAL Y HERRAJE REQUERIDOS / OUTILS ET QUINCAILLERIE REQUIS



AIW (x1)



7.1

- Insert the two left-most tabs at the bottom of the **Corner Panel (AGY)** into the two right-most slots along the edge of the Floor.
- Introduzca las lengüetas al borde inferior del **Panel angular (AGY)** en las ranuras a lo largo del borde del Piso.
- Insérez les deux languettes gauches au bord inférieur du **Panneau angulaire (AGY)** dans les deux rainures droites le long du bord du Plancher.

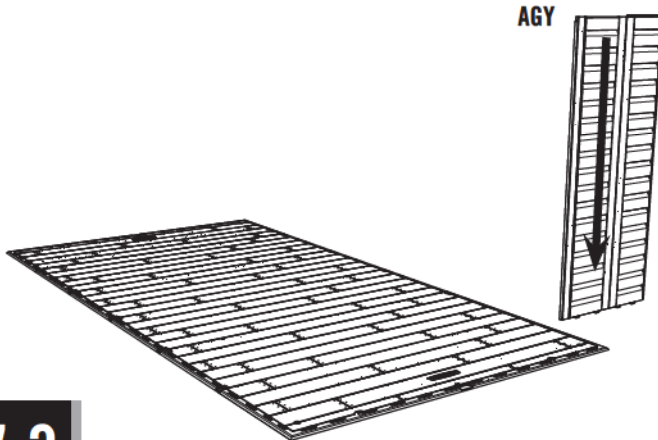

7.2

- Slide the Panel to the left.
- Deslice el Panel a la izquierda.
- Glissez le Panneau à gauche.

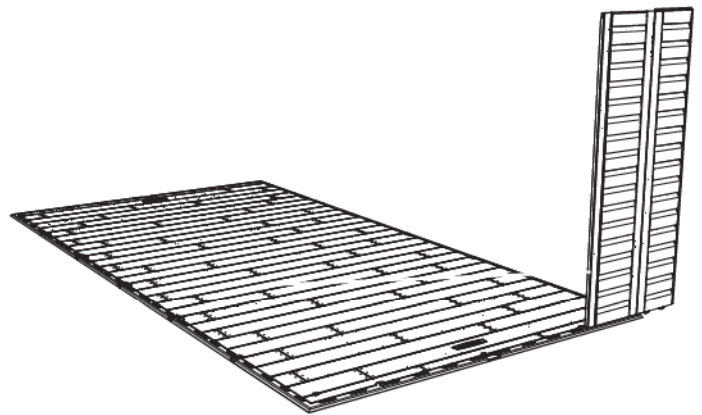

7.3

- Bend Corner Panel and pull down on the Wall Panel to insert the two remaining tabs. To help with insertion, place the **Wood Block (AIW)** under the Floor Panel directly under the tab being inserted. You should hear a “click” when the tab pops into place.
- Doble el Panel angular y tire para abajo el Panel para insertar las dos lengüetas restantes. Para ayudar con el armado, deslice el **Bloque de madera (AIW)** debajo el Panel de piso directamente debajo la lengüeta que quiere insertar. Se escucha un «clic» cuando la lengüeta se sienta en su lugar.
- Pliez le Panneau angulaire et tirez le Panneau pour insérer les deux languettes restantes. Pour aider avec le montage, mettez le **Bloque en bois (AIW)** sous le Panneau de plancher directement sous la languette que vous voulez insérer.

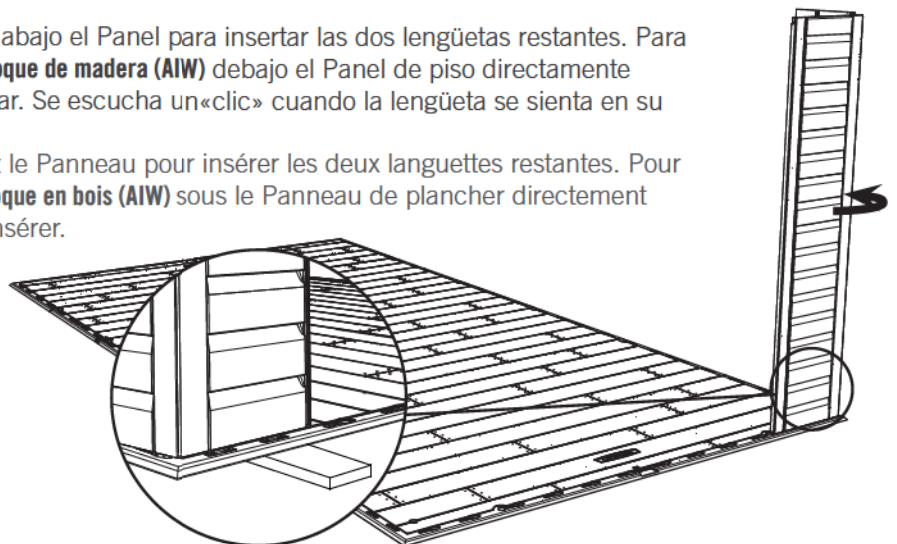

Note: Repeat this step for the second tab.

Nota: Repita este proceso para la segunda lengüeta.

Note : Répétez ce processus pour la deuxième languette.

► SECTION 7 (CONTINUED) / SECCIÓN 7 (CONTINUACIÓN) / SECTION 7 (SUITE)

TOOLS AND HARDWARE REQUIRED / INSTRUMENTAL Y HERRAJE REQUERIDOS / OUTILS ET QUINCAILLERIE REQUIS



AIW (x1)

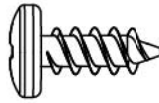

ADZ (x40)

7.4

• One at a time, insert the four tabs at the bottom of a **Wall Panel (AHD)** or **Window Wall Panel (AHH)** into the next four slots along the edge of the Floor. Slide the Panels toward the front. **The Window Wall Panels may be inserted on either side of the shed.**

• Uno por uno, inserte las cuatro lengüetas al borde inferior del **Panel mural (AHD)** o **Panel mural para la ventana (AHH)** en las cuatro ranuras siguientes a lo largo del borde del Piso. Deslice los Paneles hacia al frente. **Se pueden insertar los Paneles murales para la ventana en cualquiera de los dos lados.**

• Un par un, insérez les quatre languettes au bord inférieur du **Panneau mural (AHD)** ou **Panneau mural pour la fenêtre (AHH)** dans les quatre rainures suivantes le long du bord du Plancher. Glissez les Panneaux vers la partie avant. **Vous pouvez insérer les deux Panneaux muraux pour la fenêtre soit le côté droit soit le côté gauche.**

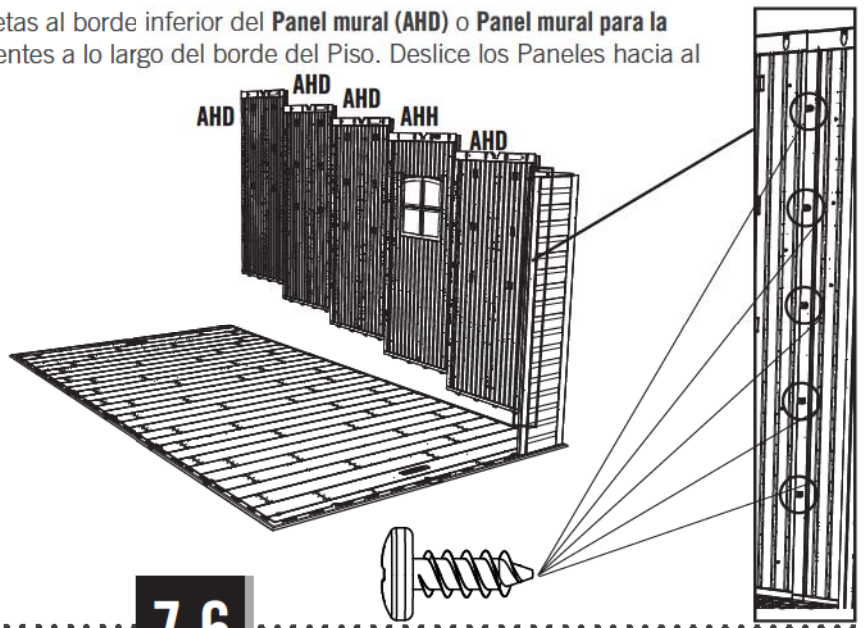

7.5

- Insert this Corner **Wall Panel (AGW)** in the same way as the previous one.
- Inserte este **Panel angular (AGW)** en la misma manera que el Panel angular anterior.
- Insérez le **Panneau angulaire (AGW)** dans la même manière que le Panneau angulaire précédent.

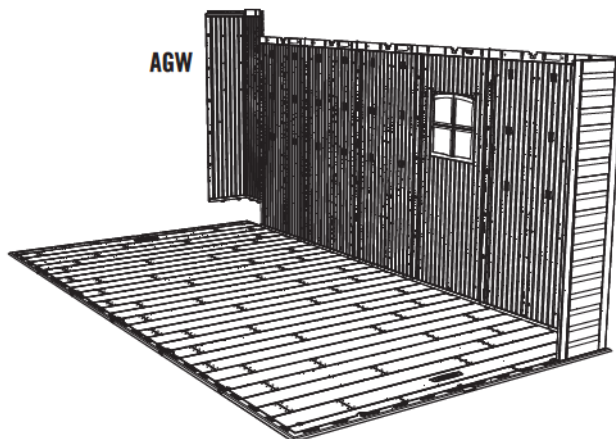

7.6

- Insert these **Wall Panels (AHD)** in the same way as the previous ones. **Do not place Window Wall Panels along the rear of the the Shed.**
- Inserte estos **Paneles murales (AHD)** en la misma manera que los Paneles anteriores. **No inserte los Paneles murales para la ventana a lo largo del borde trasero de la caseta.**
- Insérez ces **Panneaux muraux (AHD)** dans la même manière que les Panneaux précédents. **N'insérez pas les deux Panneaux muraux pour la fenêtre le long de bord arrière de l'abri.**

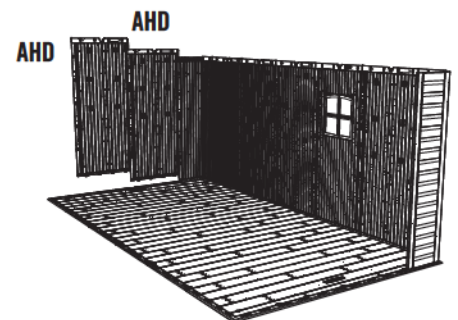

► SECTION 7 (CONTINUED) / SECCIÓN 7 (CONTINUACIÓN) / SECTION 7 (SUITE)

TOOLS AND HARDWARE REQUIRED / INSTRUMENTAL Y HERRAJE REQUERIDOS / OUTILS ET QUINCAILLERIE REQUIS



AIW (x1)

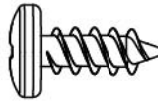

ADZ (x35)

7.7

- Insert this Corner **Wall Panel (AGL)** in the same way as the previous one.
- Inserte este **Panel angular (AGL)** en la misma manera que el Panel angular anterior.
- Insérez le **Panneau angulaire (AGL)** dans la même manière que le Panneau angulaire précédent.

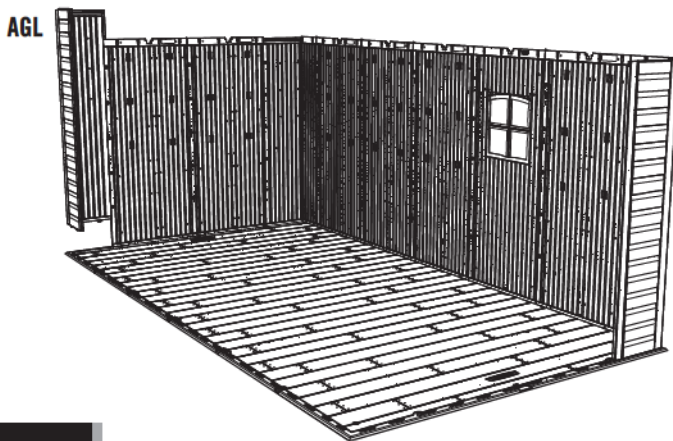

7.8

- Insert these Wall Panels in the same way as the previous ones.
- Inserte estos Paneles murales en la misma manera que los Paneles anteriores.
- Insérez ces Panneaux muraux dans la même manière que les Panneaux précédents.

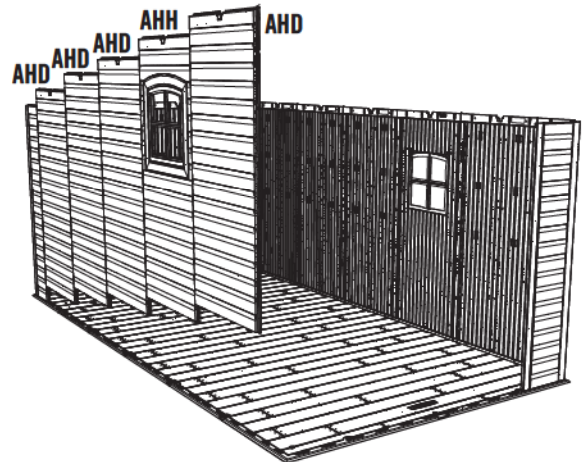

7.9

- Insert this Corner **Wall Panel (AGN)** in the same way as the previous one.
- Inserte este **Panel angular (AGN)** en la misma manera que el Panel angular anterior.
- Insérez le **Panneau angulaire (AGN)** dans la même manière que le Panneau angulaire précédent.

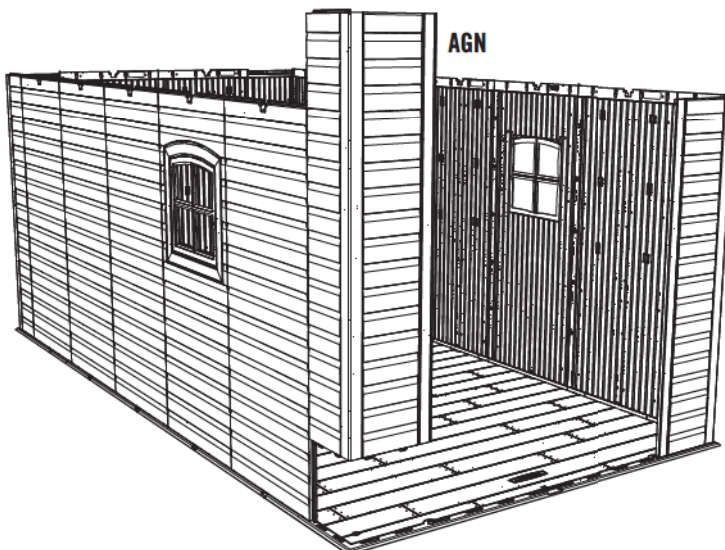



PARTS IDENTIFIER / IDENTIFICADOR DE PIEZAS / IDENTIFICATEUR DE PIÈCES

CONTENTS OF BOX 1 / CONTENIDO DE LA CAJA 1 / CONTENU DE LA BOÎTE 1

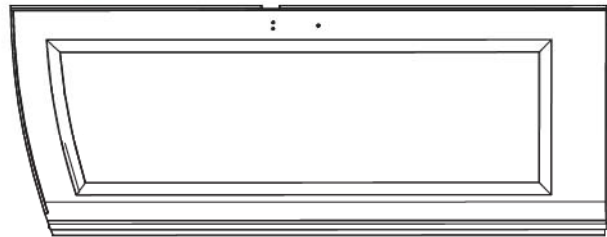

AGO (x1)

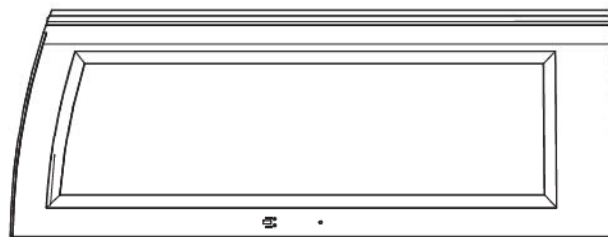

AGZ (x1)

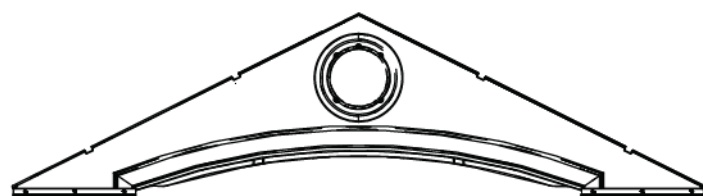

AGF (x1)

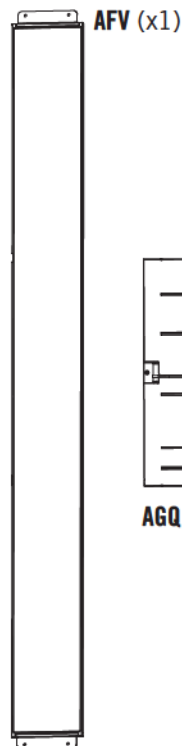

AFV (x1)

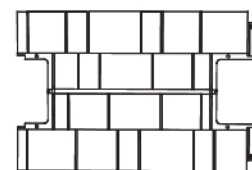

AFY (x4)

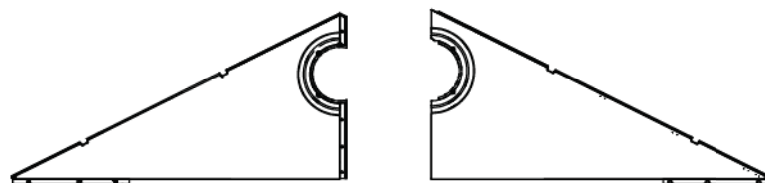

AGI (x1)

AGH (x1)

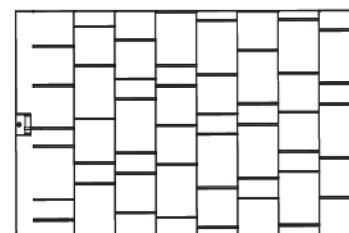

AGQ (x10)

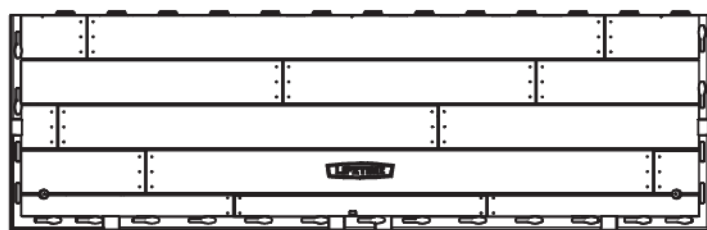

CUW (x2)



AFS (x2)

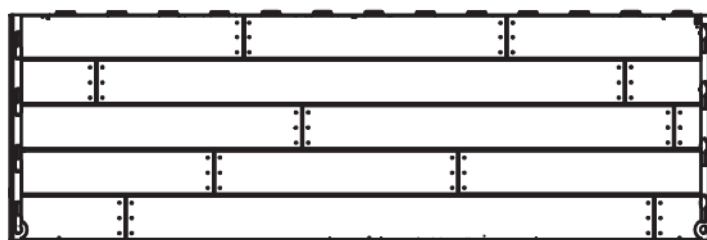

CUD (x3)

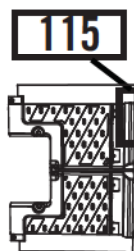

AGG (x1)

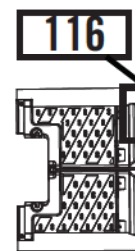

AFW (x1)

Remove This Section / Retire Esta Sección / Enlevez Cette Section



PARTS IDENTIFIER / IDENTIFICADOR DE PIEZAS / IDENTIFICATEUR DE PIÈCES

CONTENTS OF METAL KIT 1 / CONTENIDO DEL JUEGO DE METAL 1 / CONTENU DU KIT EN MÉTAL 1

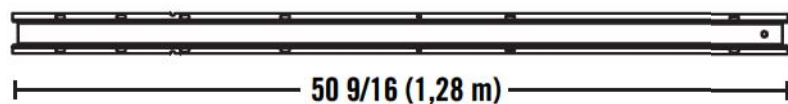

DSR (x8)



Remove This Section / Retire Esta Sección / Enlevez Cette Section

CONTENTS METAL KIT 2 / CONTENIDO DEL KIT DE PIEZAS DE METAL 2 / CONTENU DU KIT DE PIÈCES EN MÉTAL 2

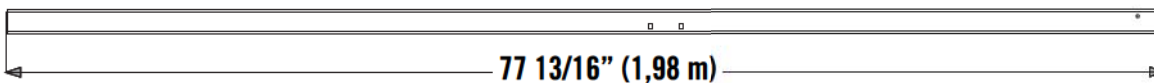

BLH (x2)

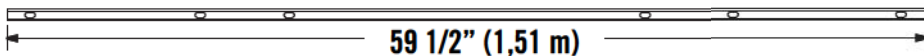
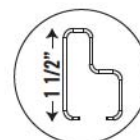

AFE (x1)

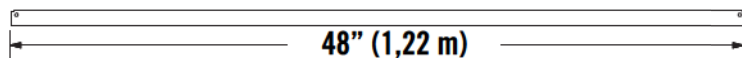
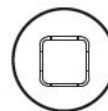

AFG (x4)

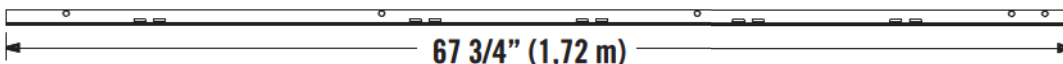

AFM (x2)

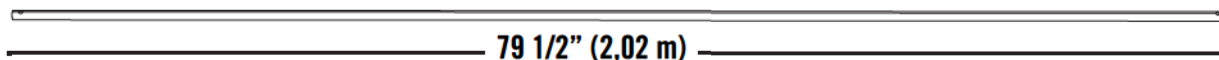

CRD (x2)

CONTENTS SMALL PARTS KIT / CONTENIDO DEL KIT DE PIEZAS PEQUEÑAS / CONTENU DU KIT DE PIÈCES EN MÉTAL



AFZ (x2)

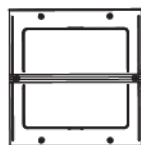

AHC (x6)



AFL (x12)



PARTS IDENTIFIER / IDENTIFICADOR DE PIEZAS / IDENTIFICATEUR DE PIÈCES

CONTENTS OF BOX 2 / CONTENIDO DE LA CAJA 2 / CONTENU DE LA BOÎTE 2

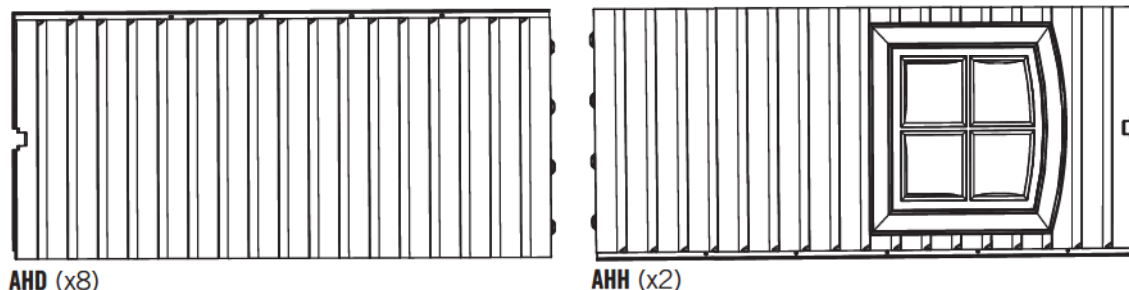
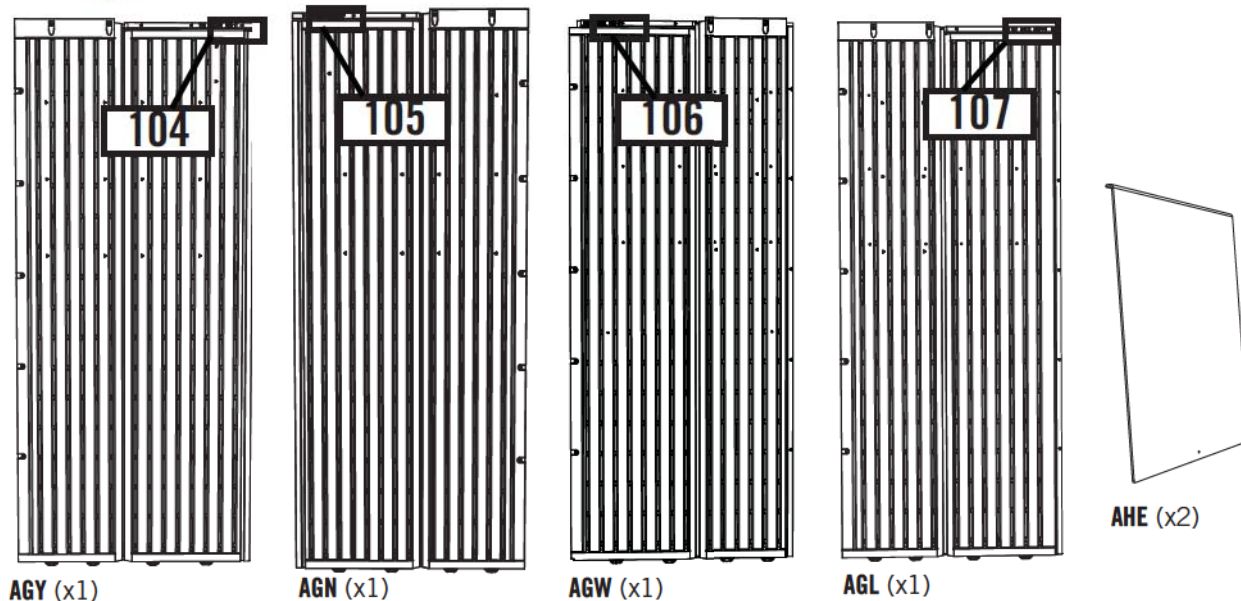

CONTENTS OF SMALL PARTS BOX / CONTENIDO DE LA CAJA DE PIEZAS PEQUEÑAS / CONTENU DE LA BOÎTE DE PETITES PIÈCES



HARDWARE BAGS / BOLSAS DE HERRAJE / SACS DE QUINCAILLERIE



Remove This Section / Retire Esta Sección / Enlevez Cette Section



PARTS IDENTIFIER / IDENTIFICADOR DE PIEZAS / IDENTIFICATEUR DE PIÈCES

CONTENTS OF BOX 3 / CONTENIDO DE LA CAJA 3 / CONTENU DE LA BOÎTE 3

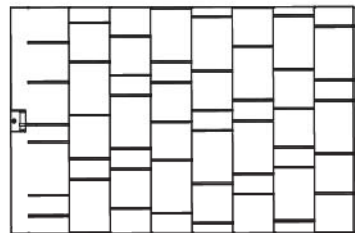

AGQ (x2)

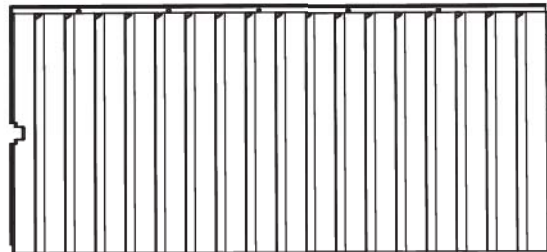

AHD (x2)

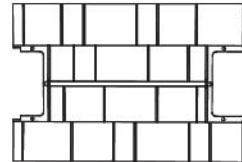

AFY (x1)

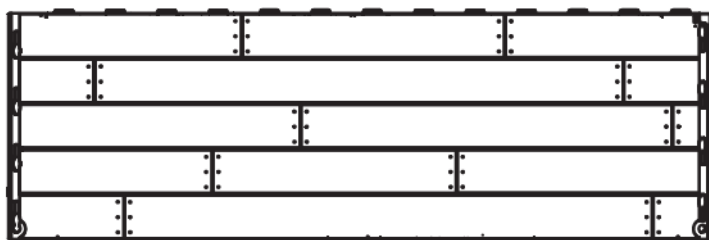

CUD (x1)

Remove This Section / Retire Esta Sección / Enlevez Cette Section

CONTENTS METAL KIT 3 / CONTENIDO DEL KIT DE PIEZAS DE METAL 3 / CONTENU DU KIT DE PIÈCES EN MÉTAL 3



DSR (x2)

50 9/16 (1,28 m)

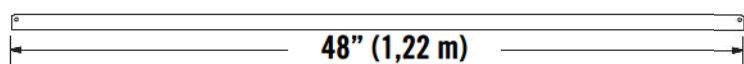

AFG (x1)

48" (1,22 m)

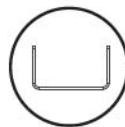



HARDWARE REQUIRED / HERRAJE REQUERIDO / QUINCAILLERIE REQUISE

Hardware Bag / Bolsa de herraje / Sac de quincaillerie

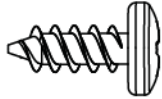

ADZ (x42)



AIY (x6)

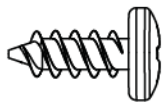

ADZ (x8)



PARTS REQUIRED / PIEZAS REQUERIDAS / PIÈCES REQUISES

Metal Parts / Piezas de metal / Pièces en métal

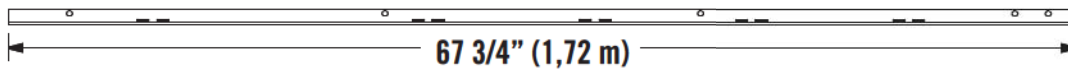

AFM (x2)

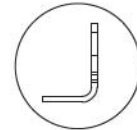

Plastic Parts / Piezas de plástico / Pièces en plastique



AFV (x1)



AFZ (x2)



AFS (x2)



TOOLS REQUIRED / INSTRUMENTAL REQUERIDO / OUTILS REQUIS



► SECTION 8 (CONTINUED) / SECCIÓN 8 (CONTINUACIÓN) / SECTION 8 (SUITE)

TOOLS AND HARDWARE REQUIRED / INSTRUMENTAL Y HERRAJE REQUERIDOS / OUTILS ET QUINCAILLERIE REQUIS

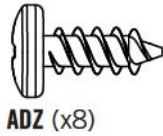

- If you have trouble with this section, follow the code below to view a video on how to install the Shelving.
- Si tiene problemas con esta sección, siga el código debajo para ver un video sobre la instalación de la Estantería.
- Si vous avez des problèmes avec cette section, suivez le code en bas pour voir un vidéo sur l'installation du rayonnage.

8.1

- The right **Wall/Shelf Support Channel (AFM)** goes in the slot directly under the notch in the Wall Panel. The left Wall Support Channel goes in the slot to the right of the notch in the Wall Panel.
- El **Canal de soporte para la pared/estante (AFM)** derecho se sujeta dentro de la ranura directamente debajo la muesca en el Panel de pared. El Canal de soporte para la pared izquierdo se sujeta dentro de la ranura a la derecha de la muesca en el Panel de pared.
- Le **Canal de support du mur/étagère (AFM)** droit s'attache dans la rainure directement sous l'encoche dans le Panneau mural. Le Canal de support du mur/étagère gauche s'attache dans la rainure à la droite de l'encoche du Panneau mural.

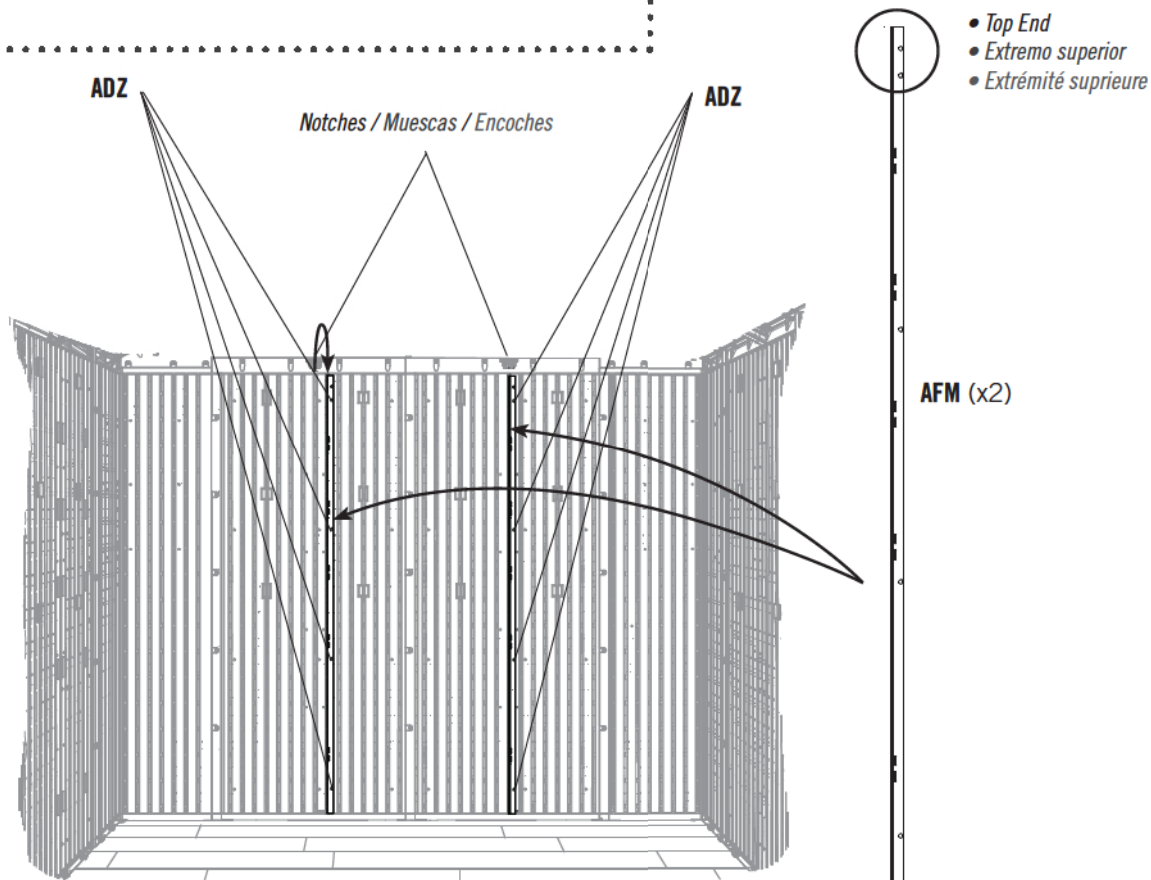

► SECTION 8 (CONTINUED) / SECCIÓN 8 (CONTINUACIÓN) / SECTION 8 (SUITE)

TOOLS AND HARDWARE REQUIRED / INSTRUMENTAL Y HERRAJE REQUERIDOS / OUTILS ET QUINCAILLERIE REQUIS

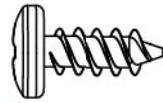

ADZ (x6)

8.2

- Insert the **Shelf Brackets (AIY)** into the slots in the Wall/Shelf Support Channels. **The Brackets must be at the same height.**
- Inserte las **Escuadras (AIY)** en las ranuras en los Canales de soporte para las Paredes/Estantes. **Las Escuadras deben estar a la misma altura.**
- Insérez les **Équerres (AIY)** dans les fentes dans les Canaux de support pour les Murs/Étagères. **Les Équerres doivent être à la même hauteur.**

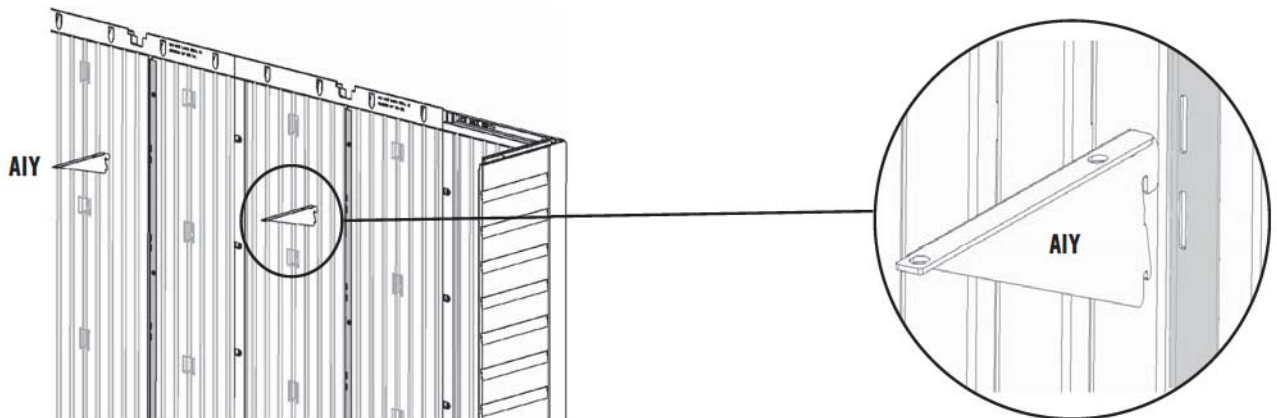

8.3

- Attach the **Shelf (AFV)** to the Corner Wall Panels and Shelf Brackets using six (6) **Screws (ADZ)**.
- Sujete el **Estante (AFV)** a los Paneles angulares y las Escuadras usando seis (6) **Tornillos (ADZ)**.
- Attachez l'Étagère (AFV) aux Panneaux angulaires et aux Équerres à l'aide de six (6) **Vis (ADZ)**.

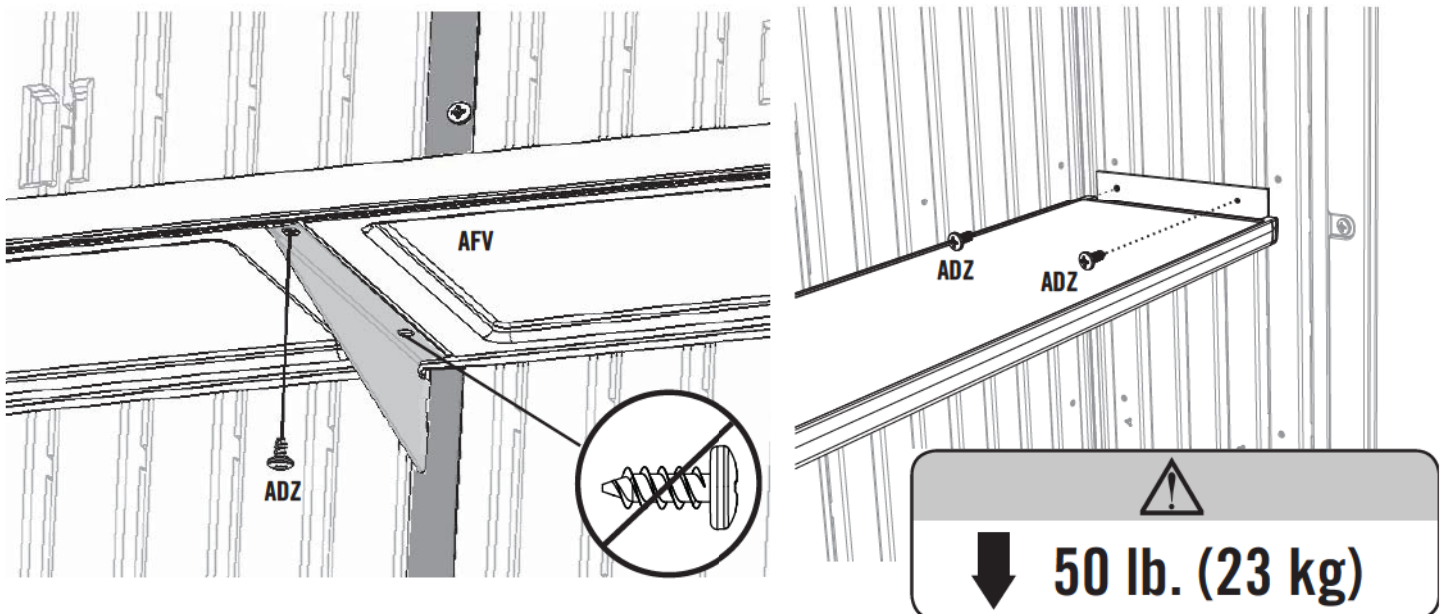

► SECTION 8 (CONTINUED) / SECCIÓN 8 (CONTINUACIÓN) / SECTION 8 (SUITE)

TOOLS AND HARDWARE REQUIRED / INSTRUMENTAL Y HERRAJE REQUERIDOS / OUTILS ET QUINCAILLERIE REQUIS

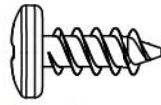

ADZ (x8)

8.4

- Insert two (2) **Shelf Brackets (AIY)** into the slots in the Wall/Shelf Support Channels. **The Shelf Brackets must be at the same height.** Attach a **Shelf (AFS)** to the Brackets using four (4) **Screws (ADZ)**.
- Inserte dos (2) **Escuadras (AIY)** en las ranuras en los Canales de soporte para las paredes/estantes. **Las Escuadras deben estar a la misma altura.** Sujete un **Estante (AFS)** a las Escuadras usando cuatro (4) **Tornillos (ADZ)**.
- Insérez deux (2) **Équerres (AIY)** dans les fentes dans les Canaux de support pour les Murs/Étagères. **Les Équerres doivent être à la même hauteur.** Attachez une **Étagère (AFS)** aux Équerres à l'aide de quatre (4) **Vis (ADZ)**.

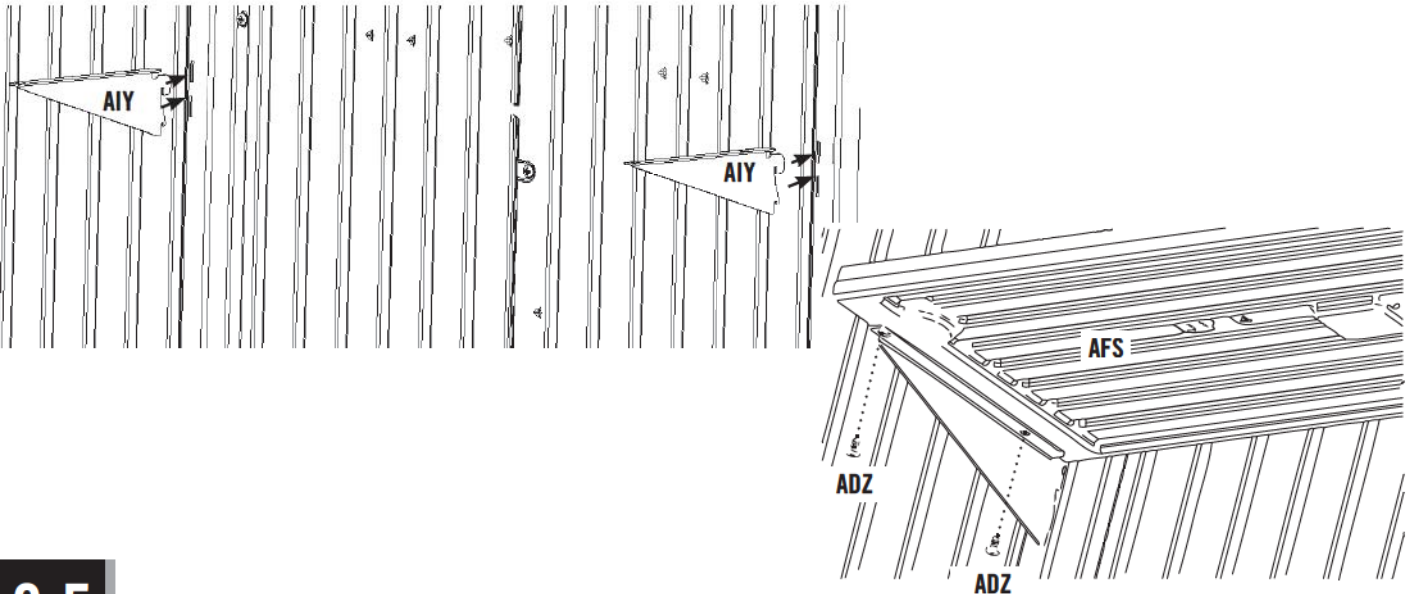

8.5

- Repeat the last step for the second Shelf.
- Repita el paso anterior para el segundo Estante.
- Répétez l'étape précédente pour la deuxième Étagère.

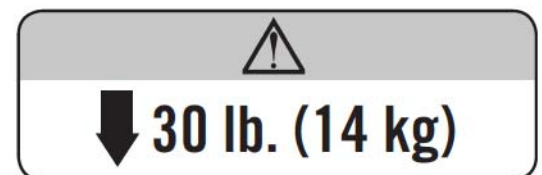

► SECTION 8 (CONTINUED) / SECCIÓN 8 (CONTINUACIÓN) / SECTION 8 (SUITE)

TOOLS AND HARDWARE REQUIRED / INSTRUMENTAL Y HERRAJE REQUERIDOS / OUTILS ET QUINCAILLERIE REQUIS

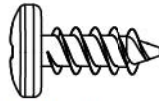

ADZ (x8)

8.6

- Select the corner in which you would like to install a **Corner Shelf (AFZ)**. In this image, the shelf is shown above the **Long Shelf**. Fold up the flaps of the Shelf, and align the holes in the tabs with those in the Corner Wall Panel. Secure with four (4) **Screws (ADZ)**.
- Seleccione el rincón en el cual le gustaría instalar un **Estante angular (AFZ)**. En esta imagen, se enseña el estante arriba del **Estante largo**. Pliegue las solapas del Estante, y alinee los agujeros en las solapas con ellos en el Panel mural angular. Sujéte el Estante al Panel usando cuatro (4) **Tornillos (ADZ)**.
- Sélectionnez l'encoignure dans laquelle vous souhaitez installer une **Étagère angulaire (AFZ)**. Dans cette image, l'étagère angulaire est illustrée au-dessus de l'**Étagère longue**. Pliez les rabats de l'Étagère angulaire, et alignez les trous avec ceux du Panneau mural angulaire. Attachez l'Étagère au Panneau à l'aide de quatre (4) **Vis (ADZ)**.

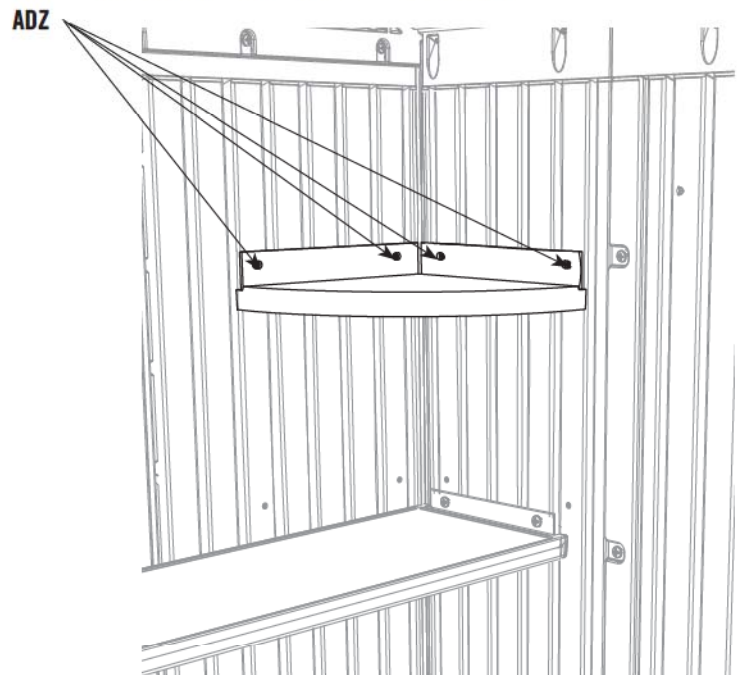
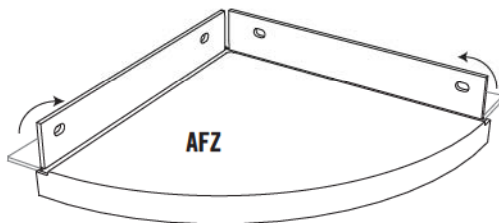

8.7

- Repeat this step to place the second **Corner Shelf** in another corner.
- Repita este paso para sujetar el segundo **Estante angular** en otro rincón.
- Répétez cette étape pour attacher la deuxième **Étagère angulaire** dans une autre encoignure.

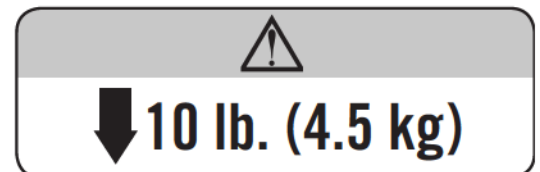

9

DOOR & ENTRY GABLE INSTALLATION / INSTALACIÓN DE LA FACHADA DE ENTRADA Y LAS PUERTAS / INSTALLATION DU TOIT À PIGNON ET LES PORTES



HARDWARE REQUIRED / HERRAJE REQUERIDO / QUINCAILLERIE REQUISE

Hardware Bag / Bolsa de herraje / Sac de quincaillerie



ADX (x4)



AHP (x2)

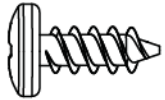

ADZ (x6)

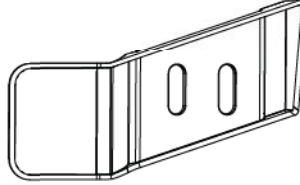

AIM (x1)

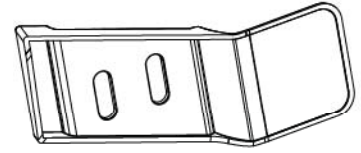

AIC (x1)



PARTS REQUIRED / PIEZAS REQUERIDAS / PIÈCES REQUISES

Plastic Parts / Piezas de plástico / Pièces en plastique

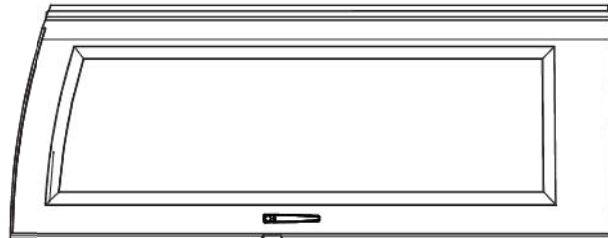
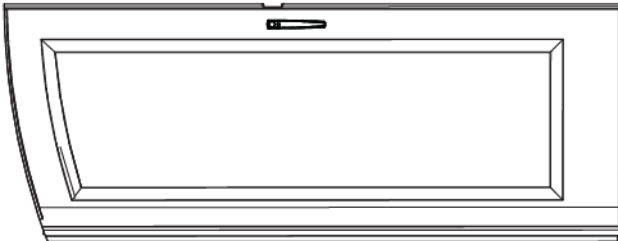
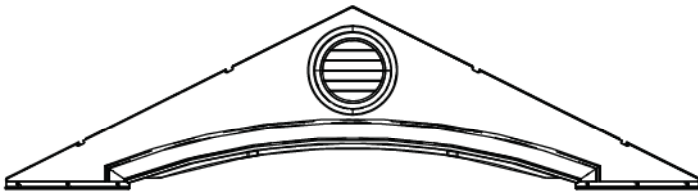

TOOLS REQUIRED / INSTRUMENTAL REQUERIDO / OUTILS REQUIS



► SECTION 9 (CONTINUED) / SECCIÓN 9 (CONTINUACIÓN) / SECTION 9 (SUITE)

TOOLS AND HARDWARE REQUIRED / INSTRUMENTAL Y HERRAJE REQUERIDOS / OUTILS ET QUINCAILLERIE REQUIS



AHP (x2)

9.1



- Pull the Hinge Tube down out of the Door about six inches. Align the hole at the bottom of the Hinge Tube with the slit in the Bushing, and insert the Tube. Insert a **Cotter Pin (AHP)** and bend the ends.
- Extienda el Tubo de articulación unos quince centímetros del borde inferior de la Puerta. Alinee el agujero en la parte inferior del Tubo con la rendija en el Casquillo, e inserte el Tubo. Inserte una **Clavija (AHP)** y doble los extremos.
- Éteignez le Tube d'articulation à peu près quinze centimètres du bord inférieur de la Porte. Alignez le trou dans la partie inférieure du Tube avec la fente dans la Bague, et insérez le Tube. Insérez une **Clavette (AHP)** et pliez les extrémités.

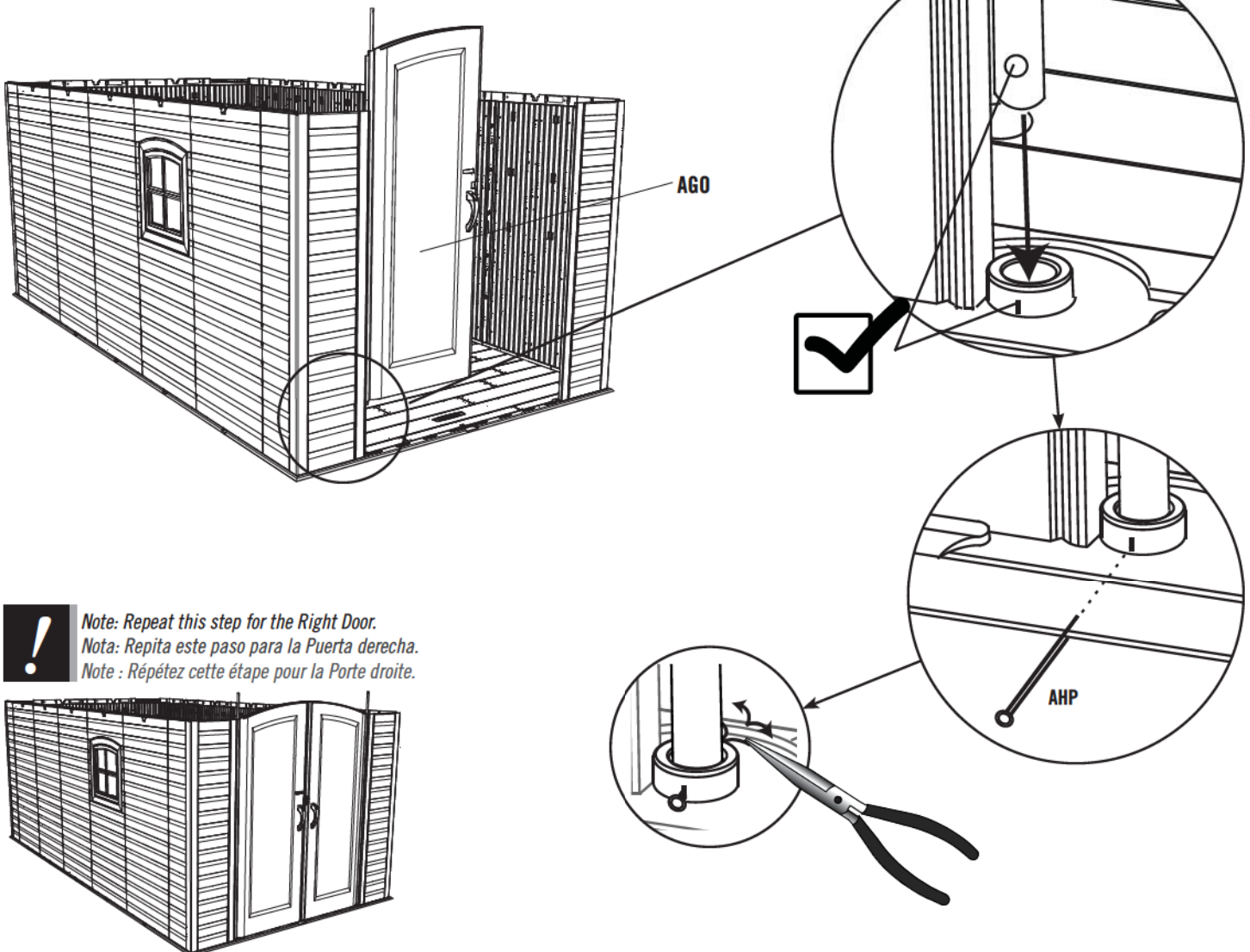

► SECTION 9 (CONTINUED) / SECCIÓN 9 (CONTINUACIÓN) / SECTION 9 (SUITE)

TOOLS AND HARDWARE REQUIRED / INSTRUMENTAL Y HERRAJE REQUERIDOS / OUTILS ET QUINCAILLERIE REQUIS

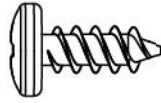

ADZ (x6)

9.2

- Slide the holes in the Entry Gable down over the two Hinge Tubes.
- Deslice los agujeros en la Fachada de entrada sobre los dos Tubos.
- Glissez les trous dans le Toit à pignon d'entrée sur les deux Tubes.

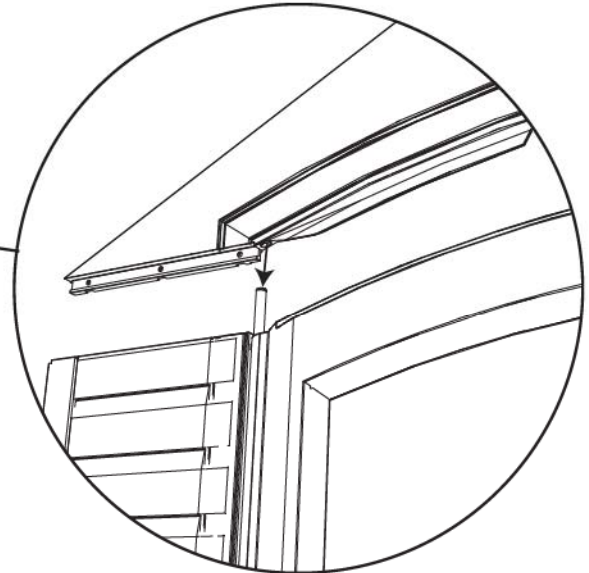
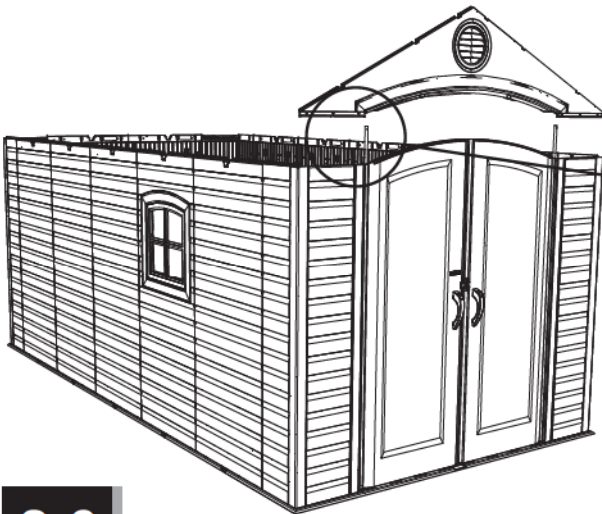

9.3

- Secure the Entry Gable to the Shed using six (6) **Screws (ADZ)**.
- Sujete la Fachada de entrada a la caseta usando seis (6) **Tornillos (ADZ)**.
- Attachez le Toit à pignon d'entrée à l'abri à l'aide de six (6) **Vis (ADZ)**.

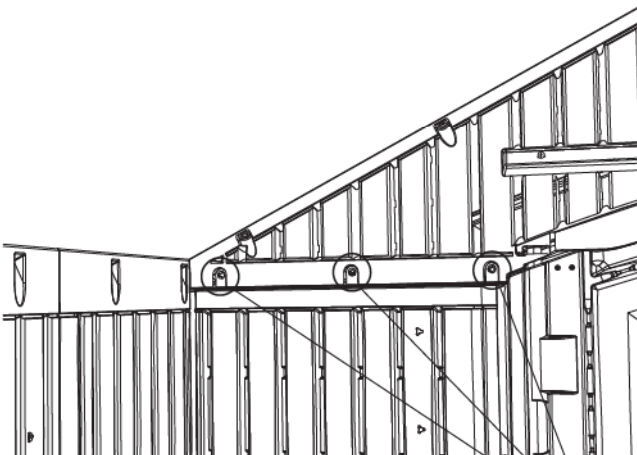

ADZ

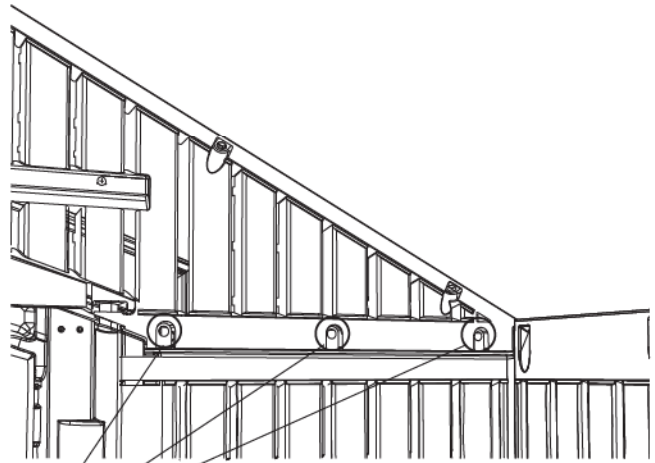

ADZ

► SECTION 9 (CONTINUED) / SECCIÓN 9 (CONTINUACIÓN) / SECTION 9 (SUITE)

TOOLS AND HARDWARE REQUIRED / INSTRUMENTAL Y HERRAJE REQUERIDOS / OUTILS ET QUINCAILLERIE REQUIS



ADX (x4)

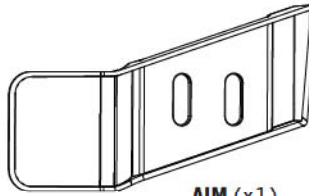

AIM (x1)

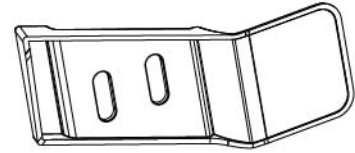

AIC (x1)

9.4

- Attach the **Left (AIC)** and **Right (AIM)** Gap Flaps to the corners of the Doors using the hardware included. **These Flaps simply serve to block out light.**
- Sujete las **Tapas de las puertas izquierda (AIC)** y **derecha (AIM)** a las Puertas usando el herraje incluido. **Estas Tapas sirven sólo para tapar la luz.**
- Attachez les **Rabats gauche (AIC)** et **droit (AIM)** aux Portes à l'aide de la quincaillerie incluse. **Ces Rabats ne servent que pour empêcher la lumière d'entrer.**

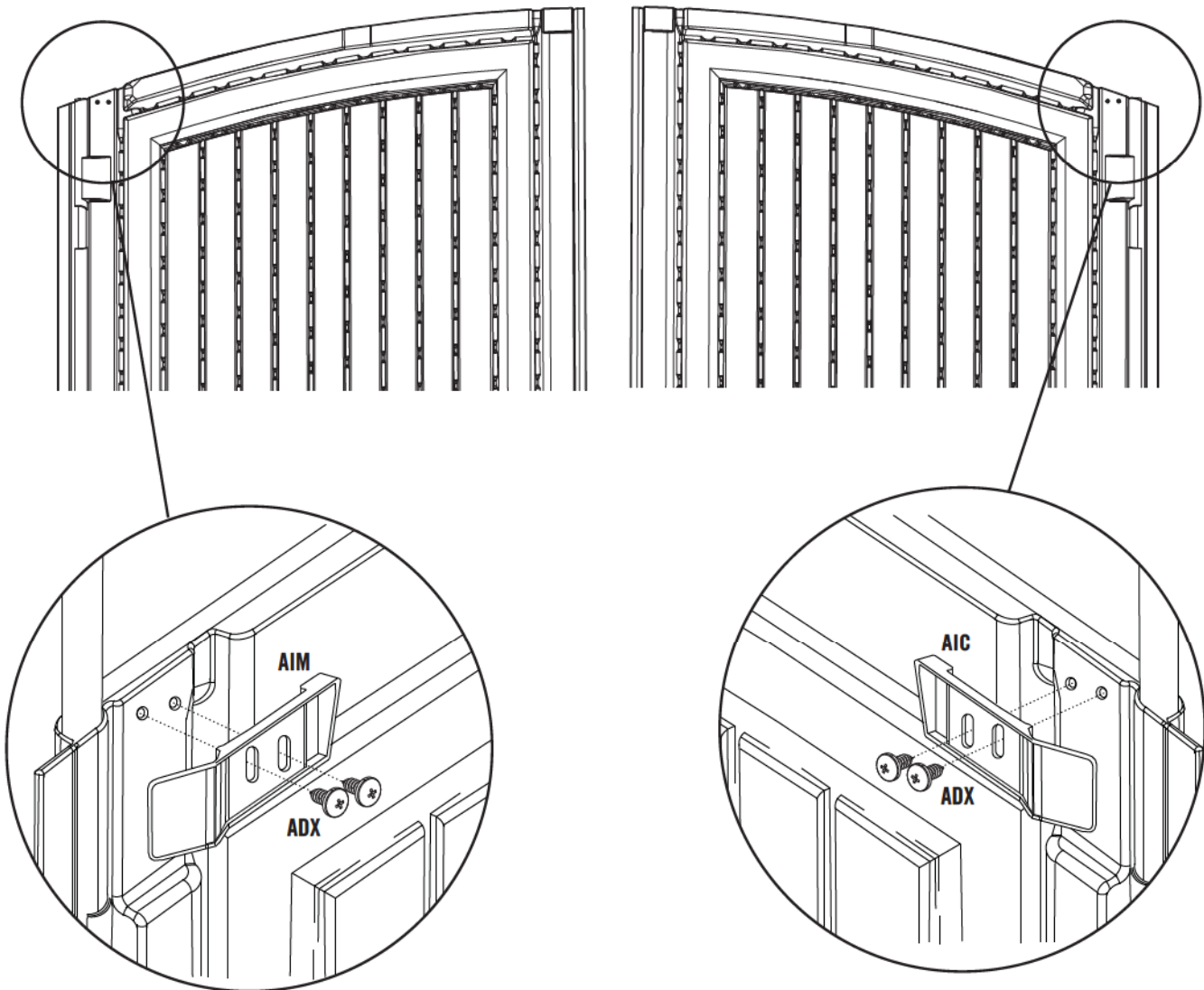



HARDWARE REQUIRED / HERRAJE REQUERIDO / QUINCAILLERIE REQUISE

Hardware Bag / Bolsa de herraje / Sac de quincaillerie

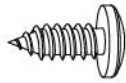

ADX (x36)

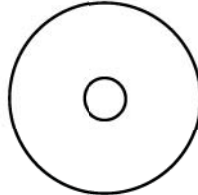

AED (x36)

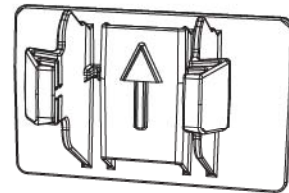

AXX (x2)

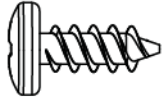

ADZ (x185)



PARTS REQUIRED / PIEZAS REQUERIDAS / PIÈCES REQUISES

Metal Parts / Piezas de metal / Pièces en métal



AFL (x12)

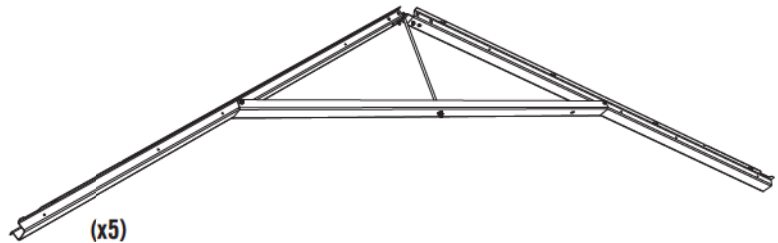

Plastic Parts / Piezas de plástico / Pièces en plastique

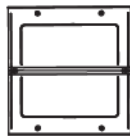

AHC (x6)

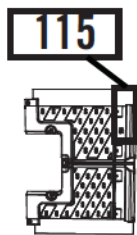

AGG (x1)

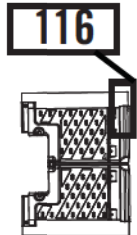

AFW (x1)

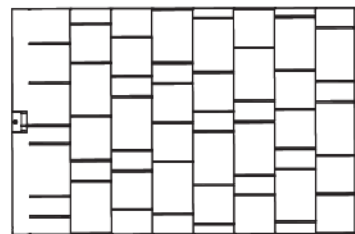

AGQ (x12)

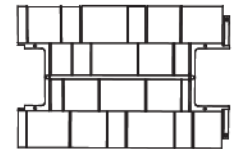
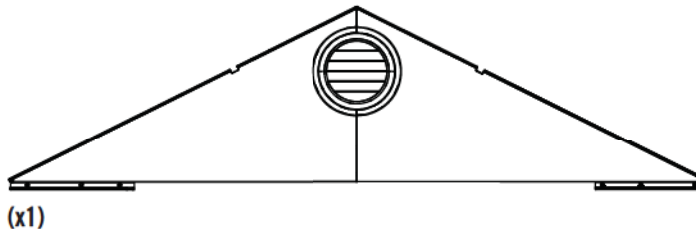

AFY (x5)



TOOLS REQUIRED / INSTRUMENTAL REQUERIDO / OUTILS REQUIS



► SECTION 10 (CONTINUED) / SECCIÓN 10 (CONTINUACIÓN) / SECTION 10 (SUITE)

TOOLS AND HARDWARE REQUIRED / INSTRUMENTAL Y HERRAJE REQUERIDOS / OUTILS ET QUINCAILLERIE REQUIS



10.1

- Set a Truss Assembly into the notches on the first two opposite Wall Panels. Set a **Roof Panel (AGQ)** onto the Gable, Wall Panel, and Truss Assembly.
- Coloque una Cercha dentro de las muescas de los primeros dos Paneles de pared opuestos. Coloque un **Panel de tejado (AGQ)** sobre la Fachada de entrada, Panel mural, y la Cercha.
- Mettez une Ferme dans les encoches des premiers deux Panneaux muraux opposés. Mettez un **Panneaux de toit (AGQ)** sur le Toit à pignon, Panneau mural, et la Ferme.

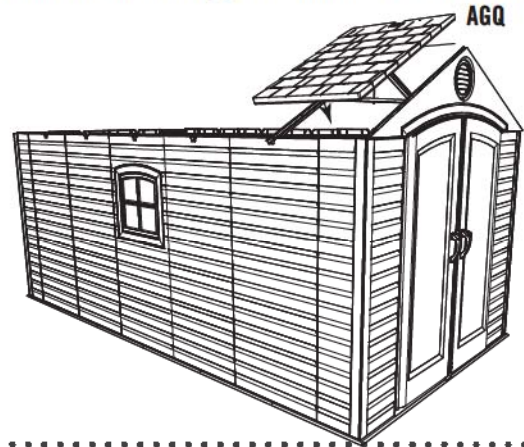
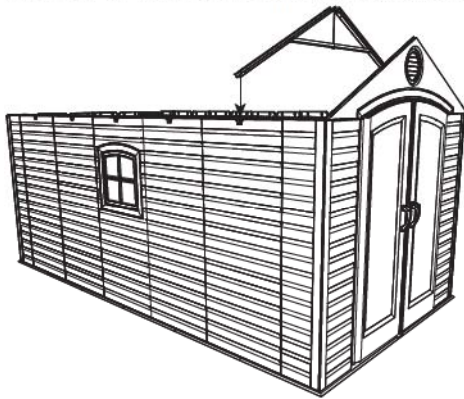

10.2

- The groove at the bottom of the Roof Panel sets over the top of the Wall Panel. Ensure the alignment nub fits into the notch in the Truss.
- Coloque la ranura a lo largo del borde inferior del Panel de tejado sobre la parte superior del Panel de pared. Encaje el bulto de alineamiento en la muesca en la Cercha.
- Mettez la rainure au bord inférieur du Panneau de toit sur la partie supérieure du Panneau mural. Mettez la petite bosse d'alignement dans l'encoche de la Ferme.

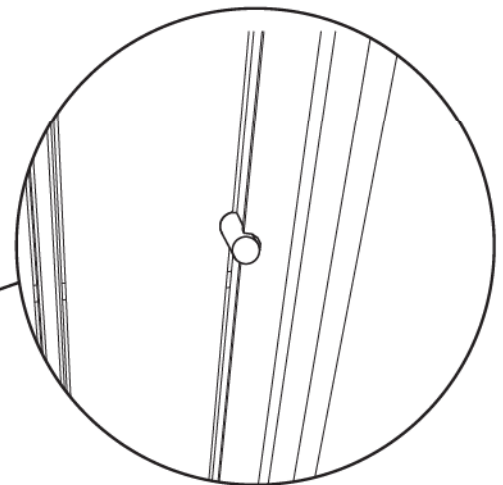
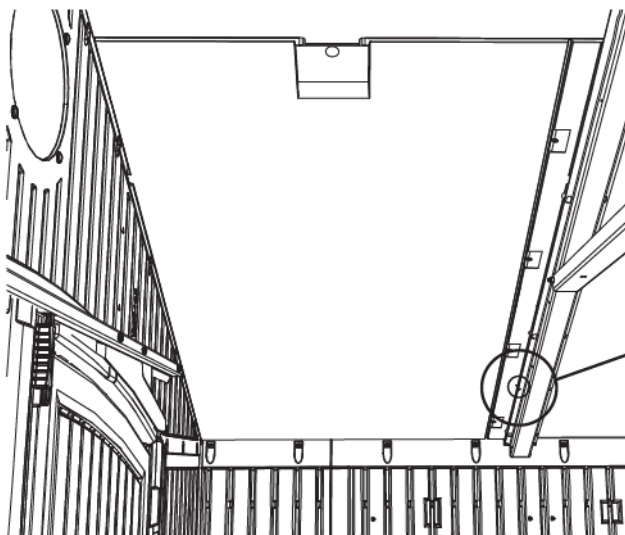

► SECTION 10 (CONTINUED) / SECCIÓN 10 (CONTINUACIÓN) / SECTION 10 (SUITE)

TOOLS AND HARDWARE REQUIRED / INSTRUMENTAL Y HERRAJE REQUERIDOS / OUTILS ET QUINCAILLERIE REQUIS

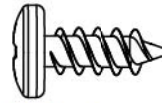

ADZ (x6)

10.3

- Align the four holes in the Wall Panel with those at the bottom of the Roof Panel, and insert four (4) **Screws (ADZ)** to secure the Panel in place.
- Alinee los cuatro agujeros en el Panel de pared con los al borde inferior del Panel de tejado, e introduzca cuatro (4) **Tornillos (ADZ)** para sujetarlo en su lugar.
- Aligned les quatre trous dans le Panneau mural avec ceux au bord inférieur du Panneau de toit, et insérez quatre (4) **Vis (ADZ)** pour attacher le Panneau en place.

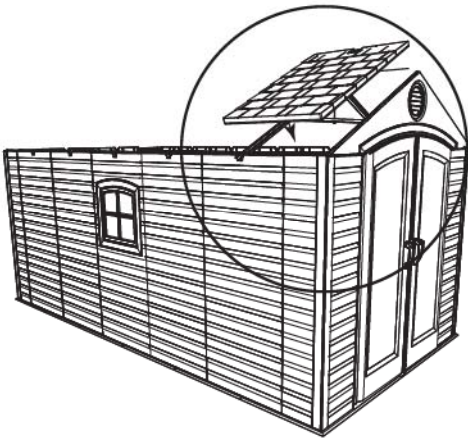

ADZ

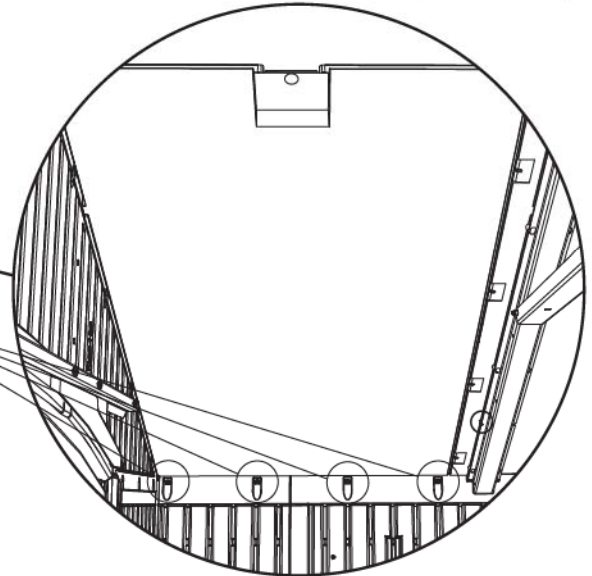

10.4

- Insert the first two **Screws (ADZ)** through the Gable and into the Roof Panel at the locations shown. Insert the **Roof Support (AFL)** into the notches in the Gable and between the Truss and the Roof Panel.
- Introduzca los primeros dos **Tornillos (ADZ)** por el Faldón y dentro del Panel de tejado a las ubicaciones ilustrados. Inserte el **Soporte de tejado (AFL)** en las muescas en el Faldón y entre la Cercha y el Panel de tejado.
- Insérez les premières deux **Vis (ADZ)** à travers le Toit à pignon et dans le Panneau de toit aux emplacements illustrés. Mettez le **Support de toit (AFL)** dans les encoches dans le Toit à pignon et entre le Panneau de toit et la Ferme.

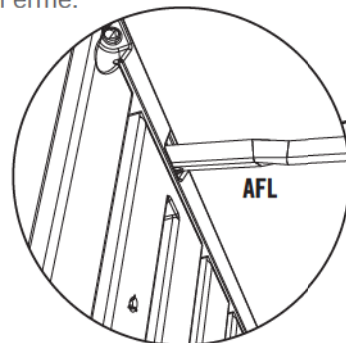

AFL

ADZ

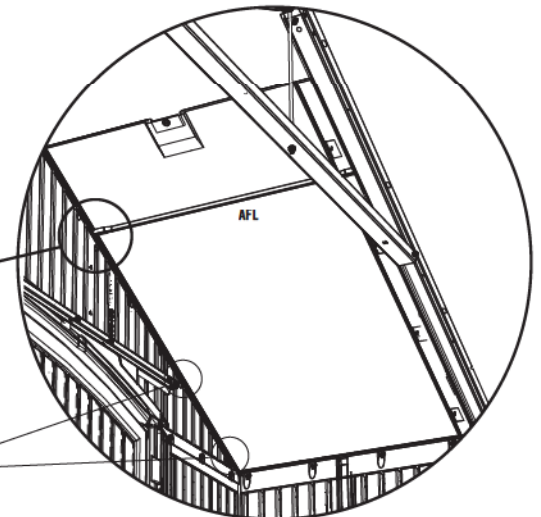

► SECTION 10 (CONTINUED) / SECCIÓN 10 (CONTINUACIÓN) / SECTION 10 (SUITE)

TOOLS AND HARDWARE REQUIRED / INSTRUMENTAL Y HERRAJE REQUERIDOS / OUTILS ET QUINCAILLERIE REQUIS

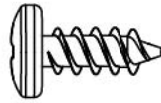

ADZ (x16)

10.5

- Insert five (5) more **Screws (ADZ)** to secure the Panel in place.
- Introduzca cinco (5) **Tornillos (ADZ)** más para sujetar el Panel en su lugar.
- Insérez cinq (5) autres **Vis (ADZ)** pour attacher le Panneau en place.

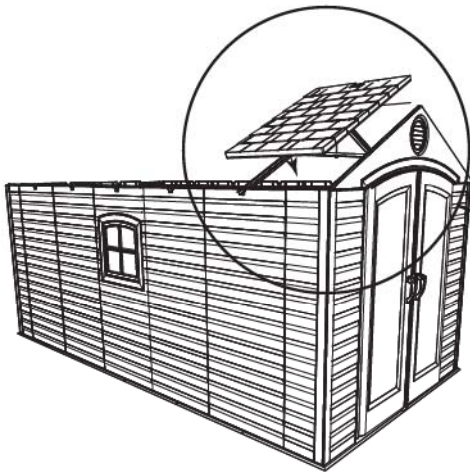

ADZ

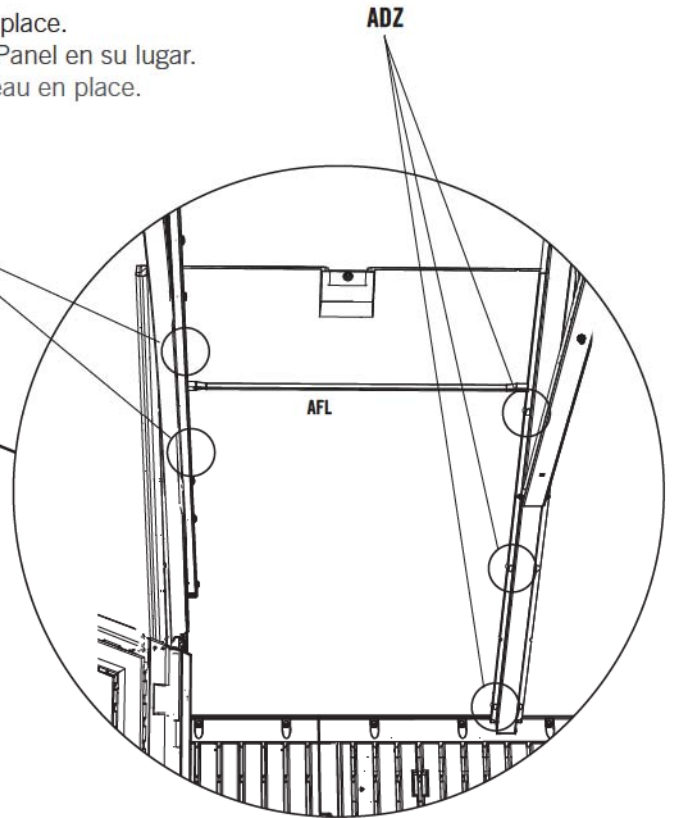

ADZ

AFL



*Note: Repeat steps 10.2 - 10.5 for the second front Roof Panel.
Nota: Repita los pasos 10.2 - 10.5 para el segundo Panel de tejado delantero.
Note : Répétez les étapes 10.2 - 10.5 pour le deuxième Panneau de toit avant.*

AFL

AGQ

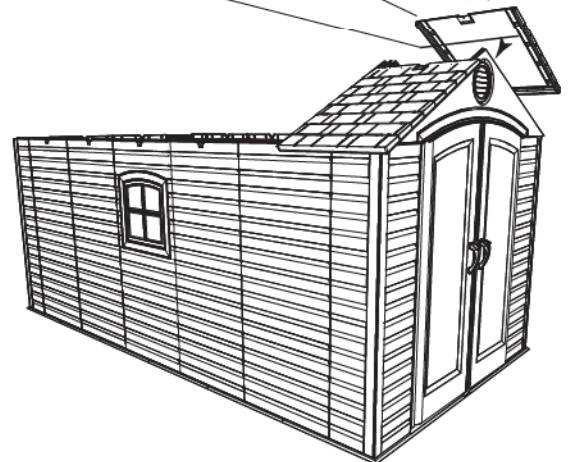

► SECTION 10 (CONTINUED) / SECCIÓN 10 (CONTINUACIÓN) / SECTION 10 (SUITE)

TOOLS AND HARDWARE REQUIRED / INSTRUMENTAL Y HERRAJE REQUERIDOS / OUTILS ET QUINCAILLERIE REQUIS

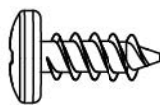

ADZ (x40)

10.6

- Attach the next four Roof Panels in a similar way as the first two.
- Sujete los siguientes cuatro Paneles de tejado en una manera similar que los primeros dos.
- Attachez les quatre Panneaux de toit suivants dans une façon similaire que les premiers Panneaux.

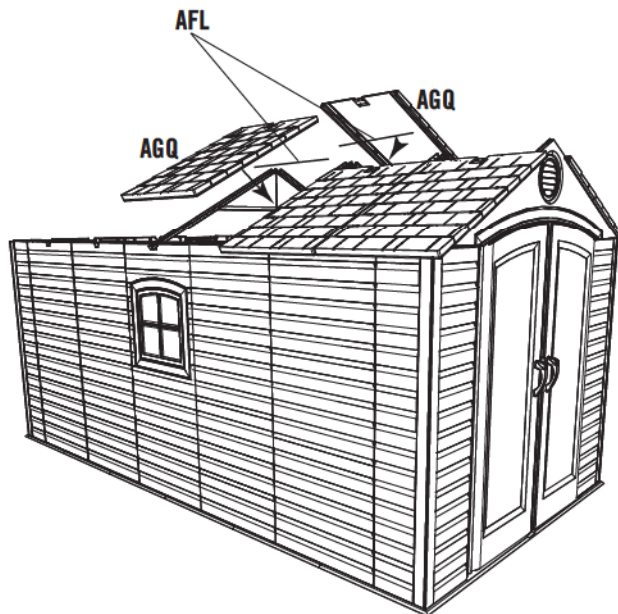
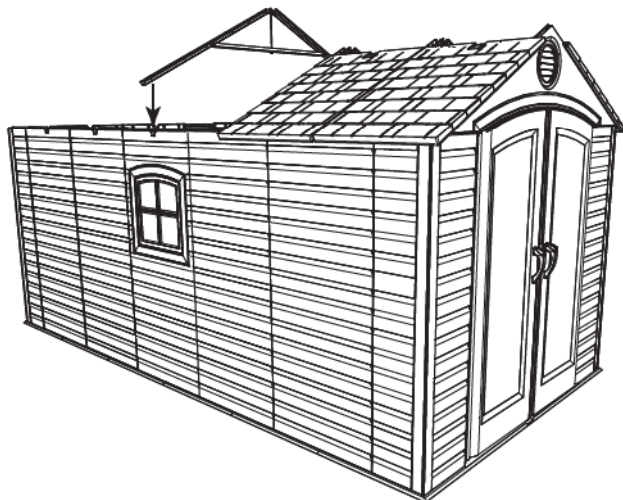
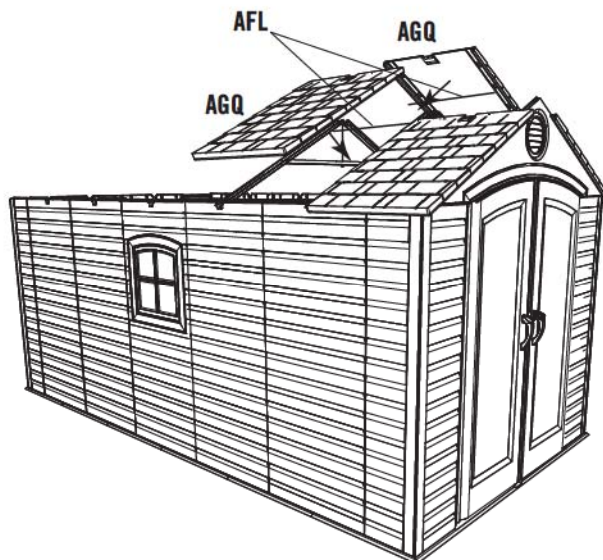
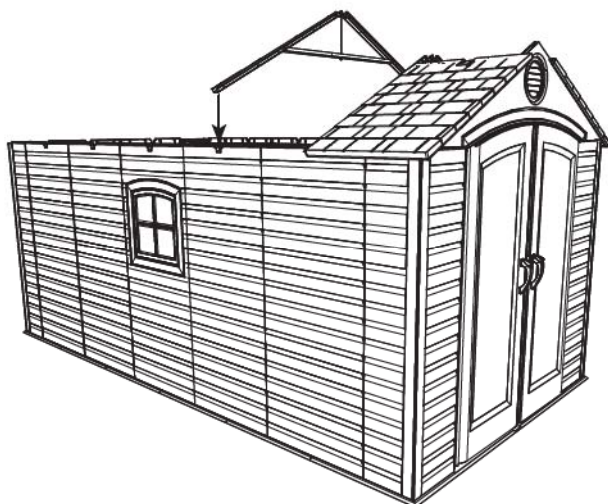

► SECTION 10 (CONTINUED) / SECCIÓN 10 (CONTINUACIÓN) / SECTION 10 (SUITE)

TOOLS AND HARDWARE REQUIRED / INSTRUMENTAL Y HERRAJE REQUERIDOS / OUTILS ET QUINCAILLERIE REQUIS

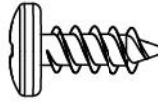

ADZ (x40)

10.7

- Attach the next four Roof Panels in a similar way as the first two.
- Sujete los siguientes cuatro Paneles de tejado en una manera similar que los primeros dos.
- Attachez les quatre Panneaux de toit suivants dans une façon similaire que les premiers Panneaux.

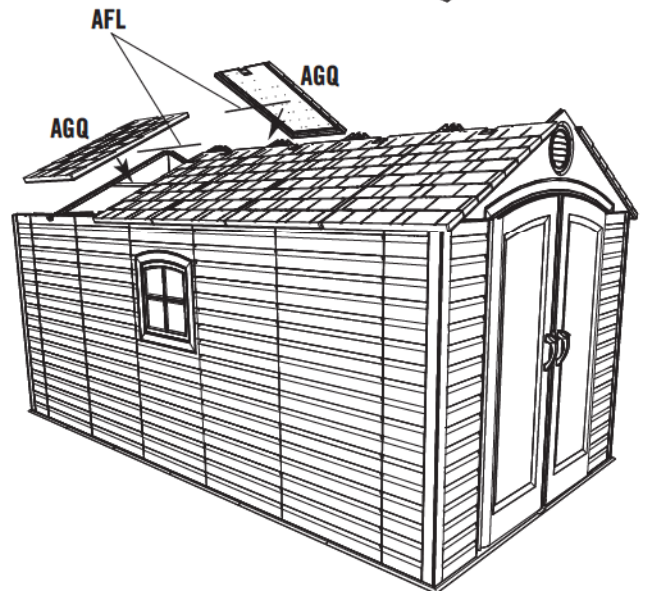
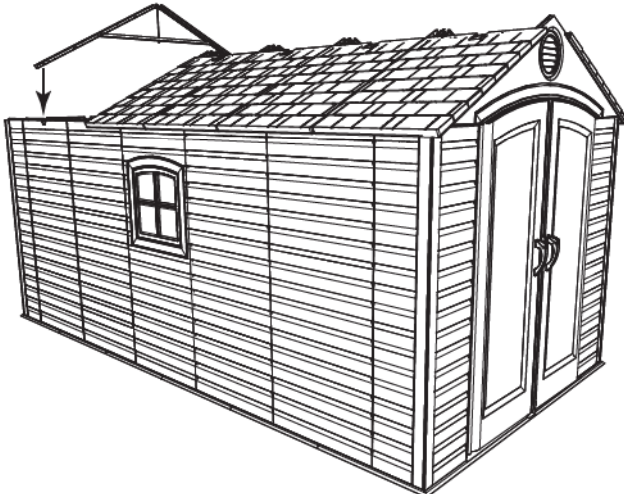
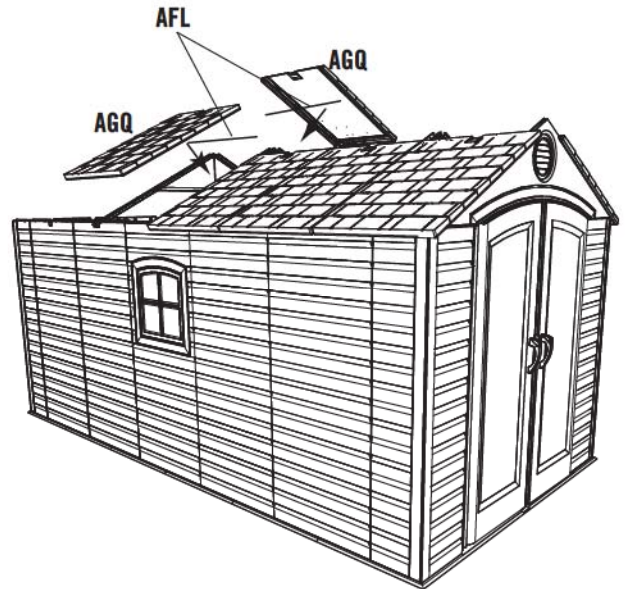
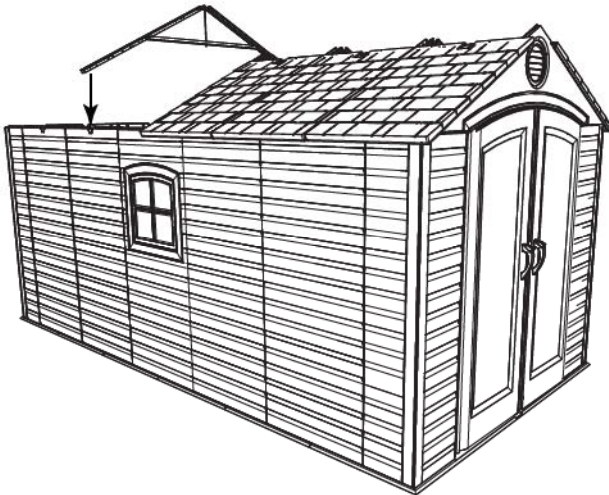

► SECTION 10 (CONTINUED) / SECCIÓN 10 (CONTINUACIÓN) / SECTION 10 (SUITE)

TOOLS AND HARDWARE REQUIRED / INSTRUMENTAL Y HERRAJE REQUERIDOS / OUTILS ET QUINCAILLERIE REQUIS

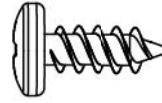

ADZ (x14)

10.8

- Attach the Rear Gable to the shed using fourteen (14) **Screws (ADZ)**.
- Sujete la Fachada trasera a la caseta usando catorce (14) **Tornillos (ADZ)**.
- Attachez le Toit à pignon arrière à l'abri à l'aide de quatorze (14) **Vis (ADZ)**.

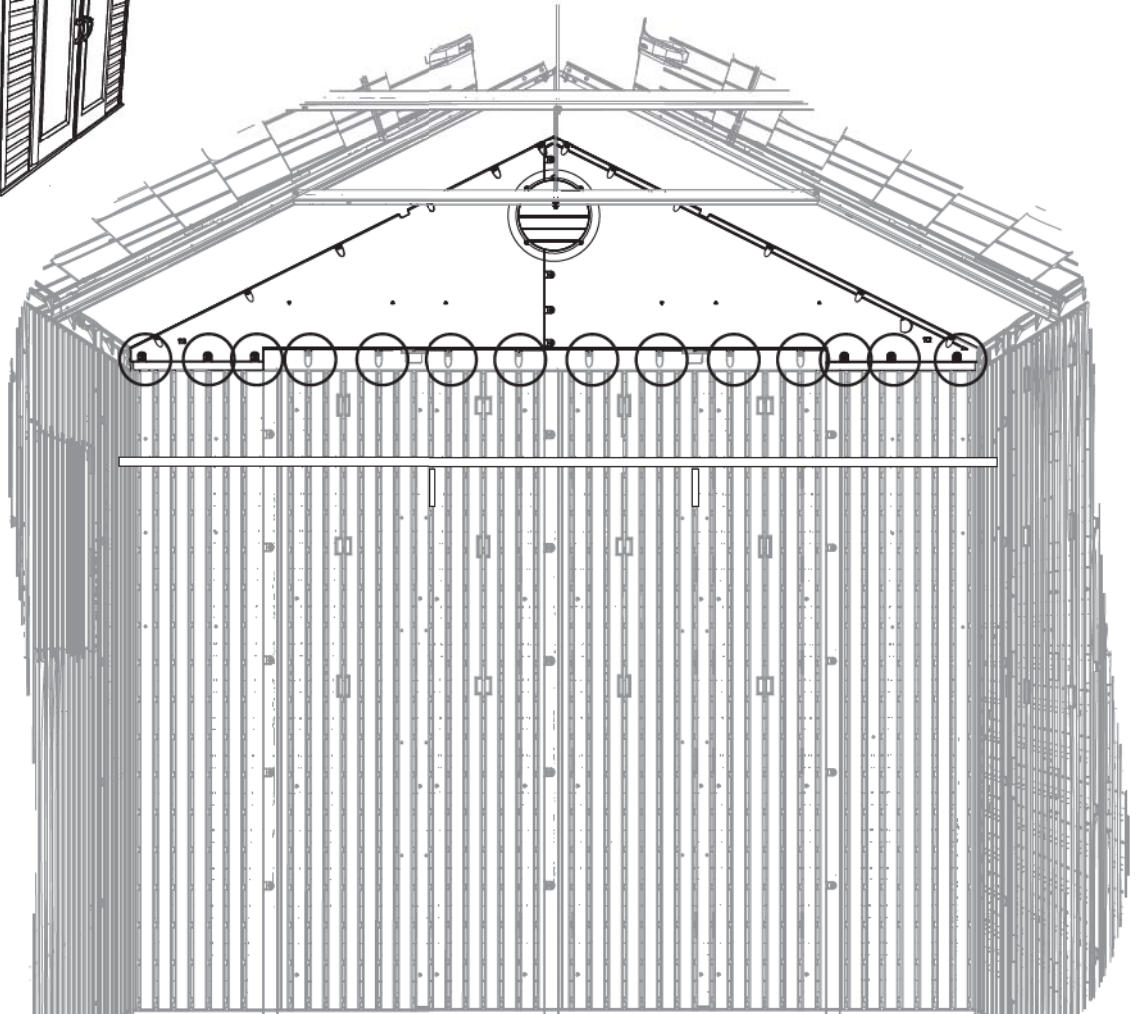

► SECTION 10 (CONTINUED) / SECCIÓN 10 (CONTINUACIÓN) / SECTION 10 (SUITE)

TOOLS AND HARDWARE REQUIRED / INSTRUMENTAL Y HERRAJE REQUERIDOS / OUTILS ET QUINCAILLERIE REQUIS

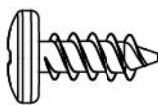

ADZ (x22)

10.9

- Attach the last two Roof Panels to the shed in the same way you did the first two.
- Sujete los últimos dos Paneles de tejado a la caseta en la misma manera que los primeros dos.
- Attachez les derniers deux Panneaux de toit à l'abri dans la même façon que les premiers deux.

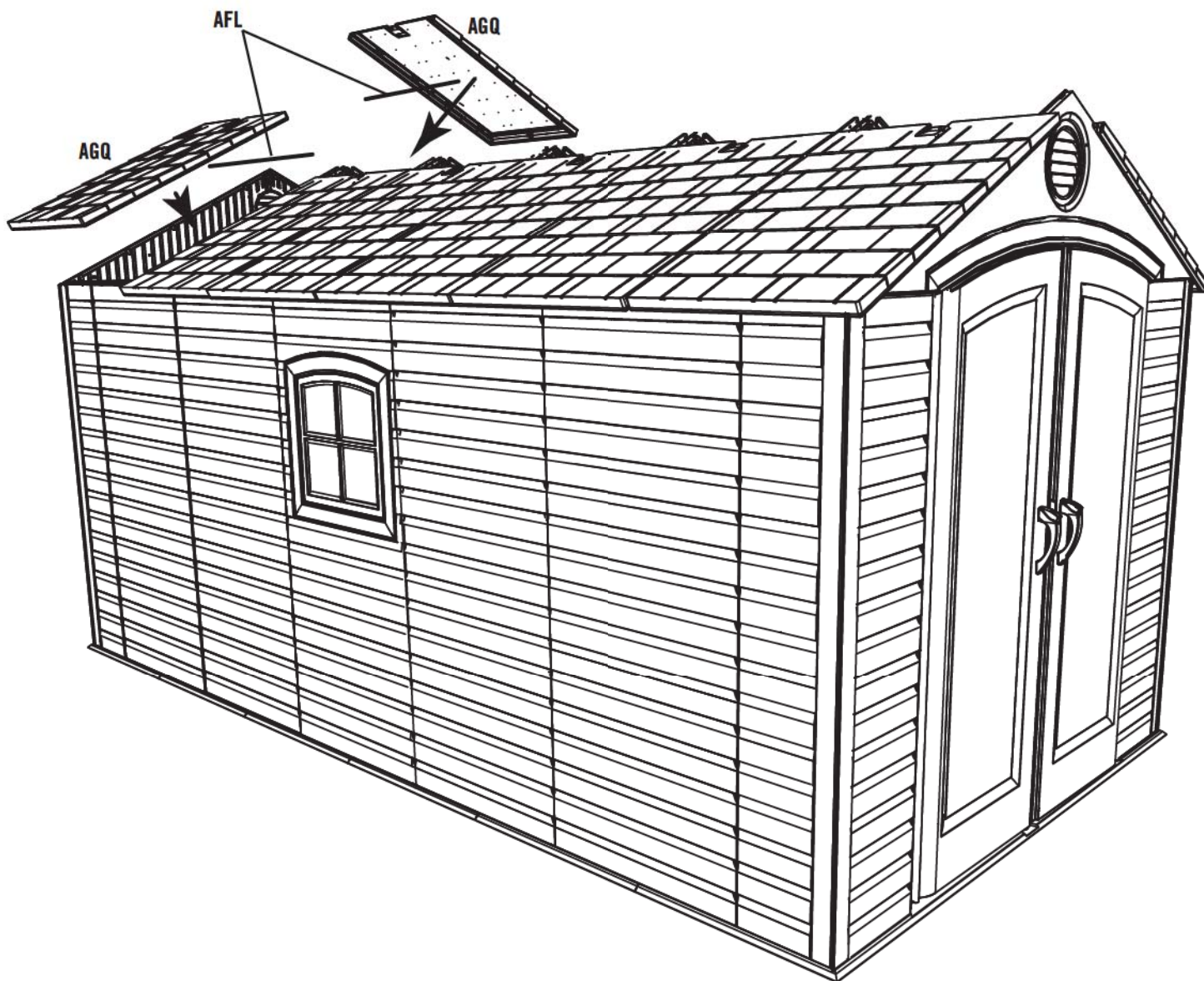

► SECTION 10 (CONTINUED) / SECCIÓN 10 (CONTINUACIÓN) / SECTION 10 (SUITE)

TOOLS AND HARDWARE REQUIRED / INSTRUMENTAL Y HERRAJE REQUERIDOS / OUTILS ET QUINCAILLERIE REQUIS

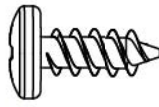

ADZ (x42)

10.10



- Starting at the front, attach the Roof Caps to the shed using the hardware included.
- Empezando a la parte delantera, sujete las Cumbresas a la caseta usando el herraje incluido.
- En commençant à la partie avant, attachez les Chapeaux à l'abri à l'aide de la quincaillerie incluse.

! *Note: The ends of the Roof Caps overlap one another.*
Nota: Los extremos de las Cumbresas se solapan.
Note : Les extrémités des Chapeaux se chevauchent.

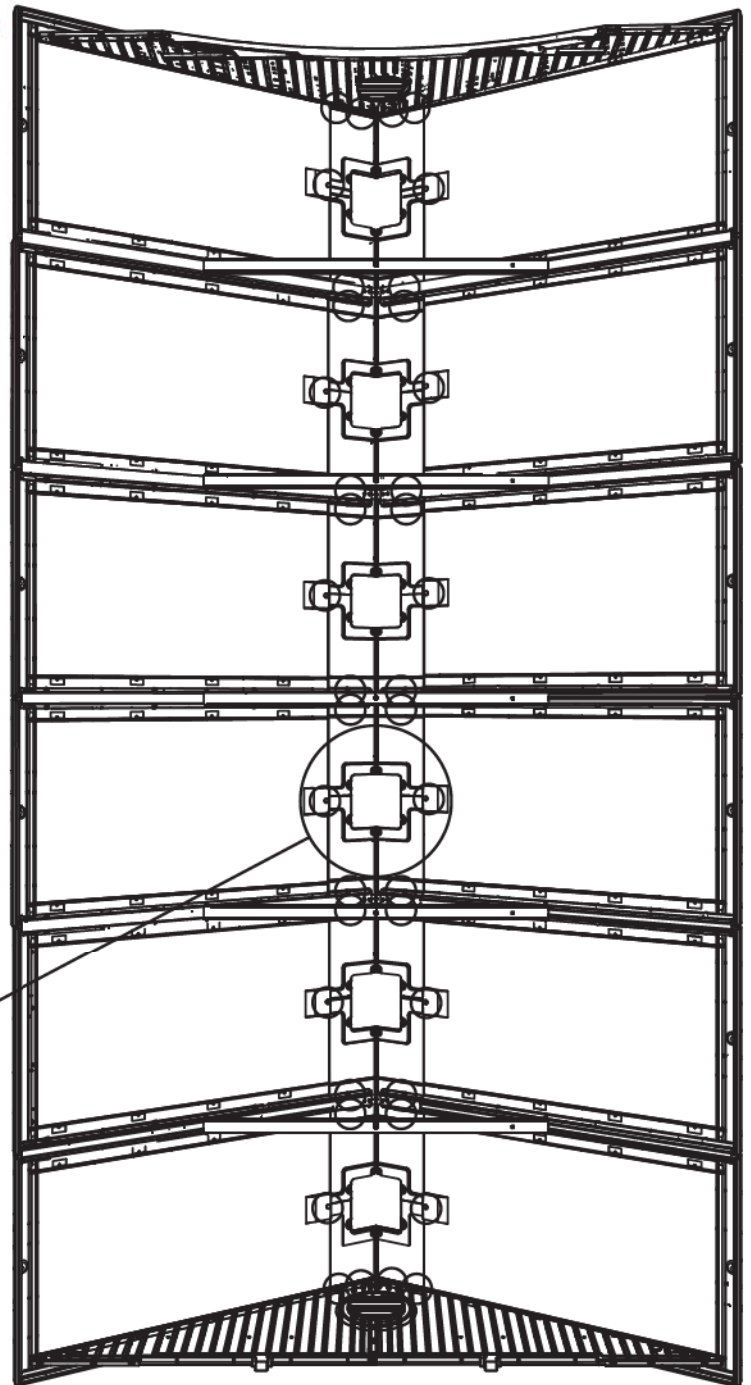
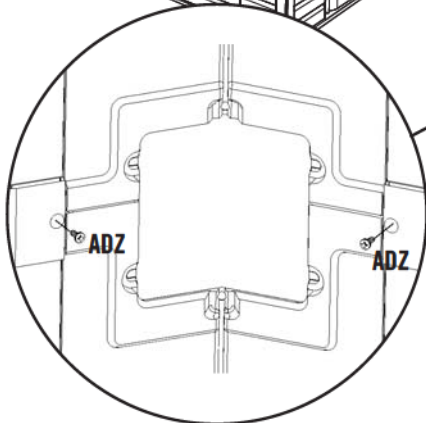
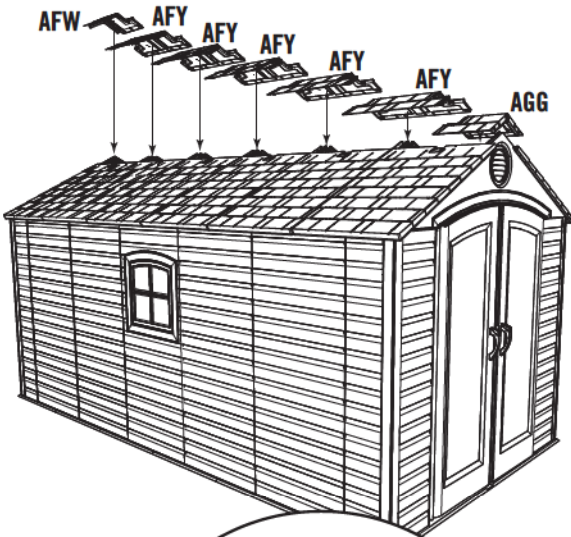

► SECTION 10 (CONTINUED) / SECCIÓN 10 (CONTINUACIÓN) / SECTION 10 (SUITE)

TOOLS AND HARDWARE REQUIRED / INSTRUMENTAL Y HERRAJE REQUERIDOS / OUTILS ET QUINCAILLERIE REQUIS

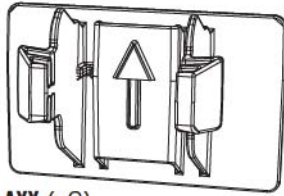

AXX (x2)



ADX (x36)

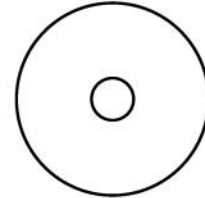

AED (x36)

10.11



- Fold a **Skylight (AHC)**, and attach it to the Roof using six (6) **Screws (ADX)** and **Washers (AED)** for each Skylight.
- Doble un **Tragaluz (AHC)**, y sujételo al tejado usando seis (6) **Tornillos (ADX)** y **Rondanas (AED)** para cada Tragaluz.
- Pliez une **Lucarne (AHC)**, et attachez-le au Toit à l'aide de six (6) **Vis (ADX)** et **Rondelles (AED)** pour chaque Lucarne.



*Note: Repeat this step for the five remaining Skylights.
Nota: Repita este paso para los cinco Tragaluz restantes.
Note : Répétez cette étape pour les cinq Lucarnes restantes.*

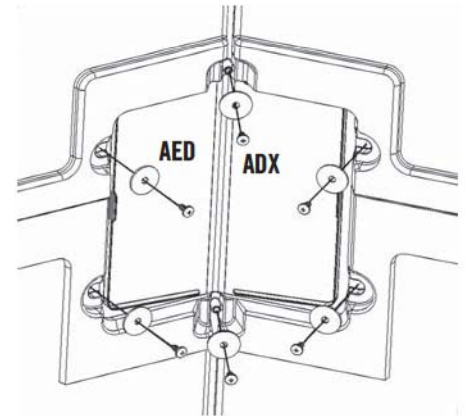
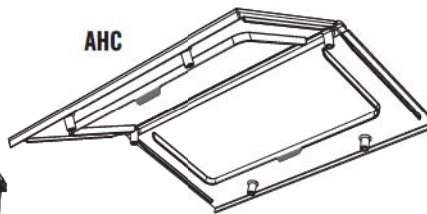
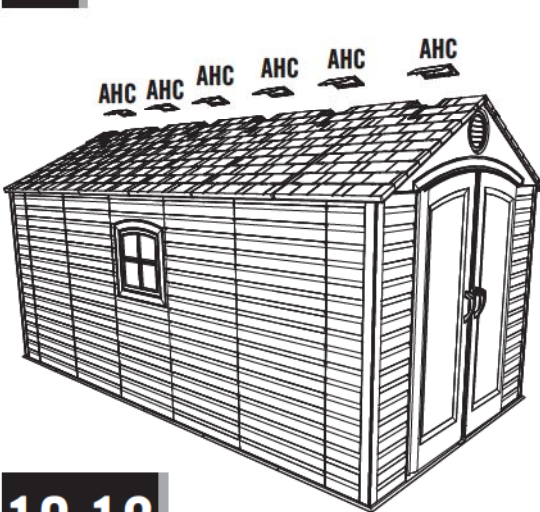

10.12

- Insert the **Clips (AXX)** with the "arrow" facing up.
- Inserte los **Clips (AXX)** con la «flecha» hacia arriba.
- Insérez les **Clips (AXX)** avec la « flèche » vers le haut.

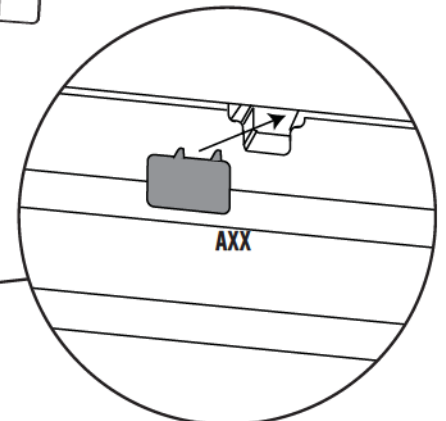
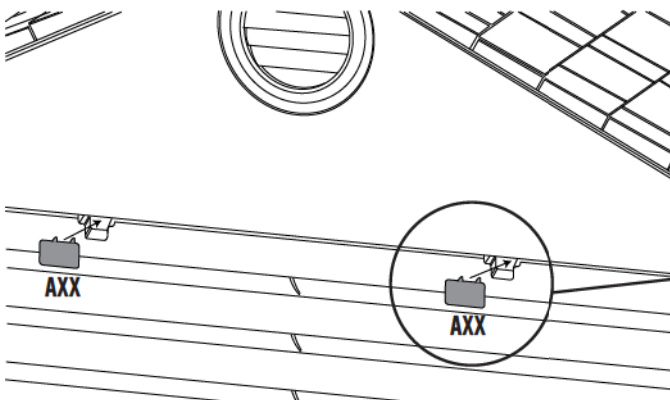
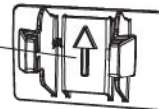

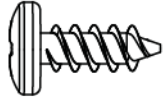

HARDWARE REQUIRED / HERRAJE REQUERIDO / QUINCAILLERIE REQUISE

Hardware Bag / Bolsa de herraje / Sac de quincaillerie

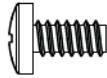

ADZ (x8)



ADY (x2)

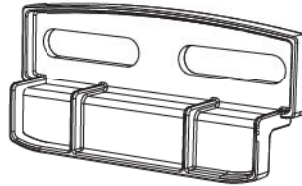

AIS (x4)

PARTS REQUIRED / PIEZAS REQUERIDAS / PIÈCES REQUISES

Plastic Parts / Piezas de plástico / Pièces en plastique



AHE (x2)

TOOLS REQUIRED / INSTRUMENTAL REQUERIDO / OUTILS REQUIS

► SECTION 11 (CONTINUED) / SECCIÓN 11 (CONTINUACIÓN) / SECTION 11 (SUITE)

TOOLS AND HARDWARE REQUIRED / INSTRUMENTAL Y HERRAJE REQUERIDOS / OUTILS ET QUINCAILLERIE REQUIS

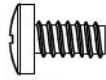

ADY (x2)



- If you have trouble with this section, follow the code below to view a video on how to install the Window Panels.
- Si tiene problemas con esta sección, siga el código debajo para ver un video sobre la instalación de las Hojas de ventana.
- Si vous avez des problèmes avec cette section, suivez le code en bas pour voir un vidéo sur l'installation des Carreaux.

11.1

- Peel off the protective backing from both sides of the **Window Pane (AHE)**.
- Retire el protector de plástico de las dos caras de la **Hoja de ventana (AHE)**.
- Retirez la pellicule protectrice des deux côtés du **Carreau (AHE)**.

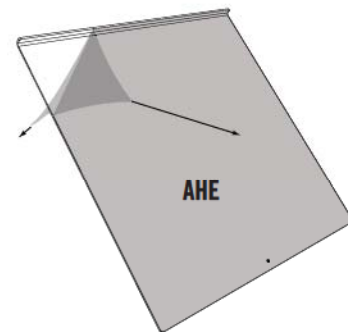

11.2

- With the curved edge at the top and facing toward you, slide the Window Pane down into the opening.
- Con el borde curvado hacia arriba y el interior, deslice la Hoja de ventana en su lugar.
- Avec le bord courbé vers le haut et faisant face de vous, glissez le Carreau en place.

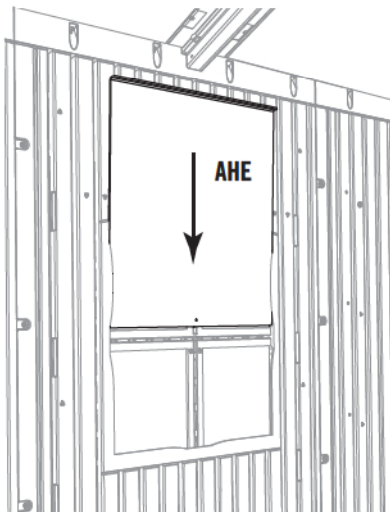

11.3

- Insert a **Screw (ADY)** into the hole at the bottom of the Window Pane. **This helps keep the Window up when open.**
- Introduzca un **Tornillo (ADY)** en el agujero al borde inferior de la Hoja. **Esto ayuda a prevenir la cierre de la Hoja de ventana.**
- Insérez une **Vis (ADY)** dans le trou au bord inférieur du Carreau. **Cela aide à maintenir le Carreau vers le haut lorsqu'il est ouvert.**

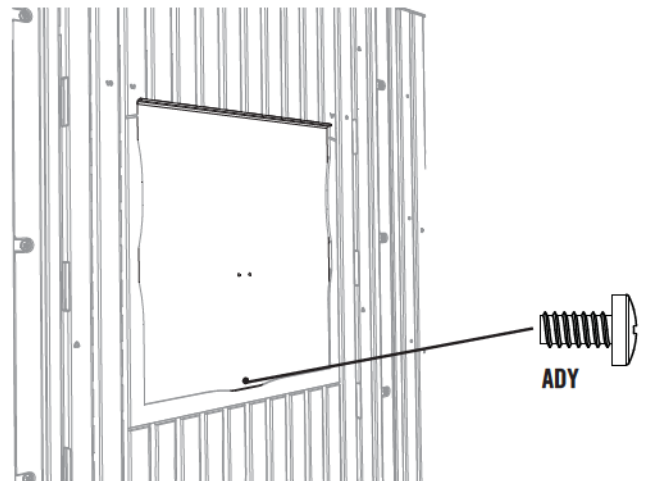

► SECTION 11 (CONTINUED) / SECCIÓN 11 (CONTINUACIÓN) / SECTION 11 (SUITE)

TOOLS AND HARDWARE REQUIRED / INSTRUMENTAL Y HERRAJE REQUERIDOS / OUTILS ET QUINCAILLERIE REQUIS

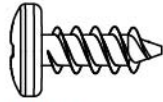

ADZ (x8)

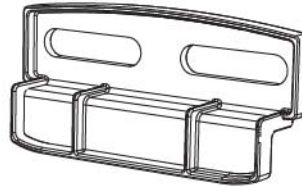

AIS (x4)

11.4

- Attach the two (2) **Window Latches (ADY)** at the top corners of the Panel opening.
- Sujete los dos (2) **Cerrojos (ADY)** a las esquinas superiores de la abertura del Panel.
- Attachez les deux (2) **Loquets (ADY)** aux angles supérieurs de l'ouverture du Panneau.

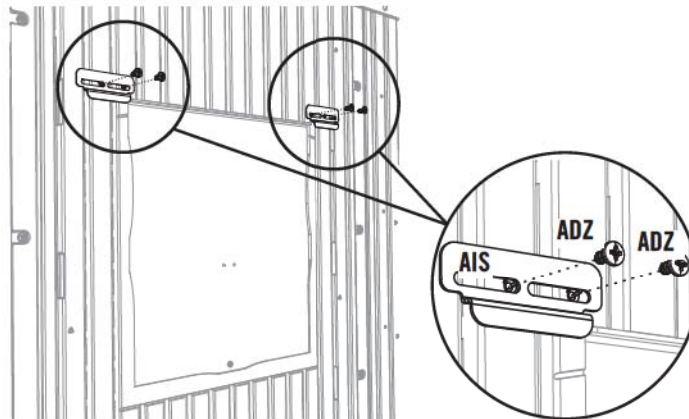

Note: The Latch should move freely.

Nota: El Cerrojo debe mover libremente.

Note : Le Loquet doit se déplacer librement.

11.5

- Repeat these steps for the second Window Pane.
- Repita estos pasos para la segunda Hoja de ventana.
- Répétez ces étapes pour le deuxième Carreau.

12

DOOR ALIGNMENT / ALINEACIÓN DE LAS PUERTAS / ALIGNEMENT DES PORTES



HARDWARE REQUIRED / HERRAJE REQUERIDO / QUINCAILLERIE REQUISE

**NO HARDWARE INCLUDED FOR THIS SECTION
NINGÚN HERRAJE INCLUIDO PARA ESTA SECCIÓN
AUCUNE QUINCAILLERIE INCLUSE POUR CETTE SECTION**



PARTS REQUIRED / PIEZAS REQUERIDAS / PIÈCES REQUISES

Woode Parts / Piezas de madera / Pièces en bois



AIX (x4)



TOOLS REQUIRED / INSTRUMENTAL REQUERIDO / OUTILS REQUIS

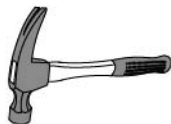

► SECTION 12 (CONTINUED) / SECCIÓN 12 (CONTINUACIÓN) / SECTION 12 (SUITE)

TOOLS AND HARDWARE REQUIRED / INSTRUMENTAL Y HERRAJE REQUERIDOS / OUTILS ET ACCESSOIRES REQUIS



AIX (x4)



12.1

- If the Doors are not level, follow the steps on this page or the next to even them out.
- Si las Puertas no están niveladas, siga los pasos en esta página o la siguiente para nivelarlas.
- Si les Portes ne sont pas niveau l'une avec l'autre, suivez les étapes dans cette page ou la suivante pour les niveler.

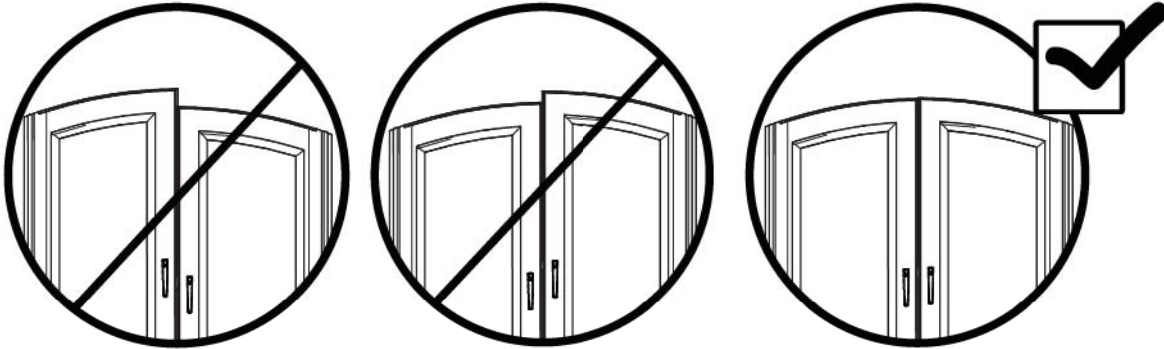

12.2

- If the Left Door is higher, insert a **Shim (AIX)** underneath the right, front and left, rear corners of the Shed until the Doors are the same height. **Break off any excess Shim.**
- Si la Puerta izquierda es más alta, inserte una **Cuña (AIX)** debajo las esquinas delantera derecha y trasera izquierda hasta que las Puertas queden a la misma altura. **Quebrante cualquier exceso de las Cuñas.**
- Si la Porte gauche est plus haute, insérez une **Cale (AIX)** sous le coin avant droit jusqu'à ce que les Portes restent à la même hauteur. **Détachez de l'excès des Cales.**

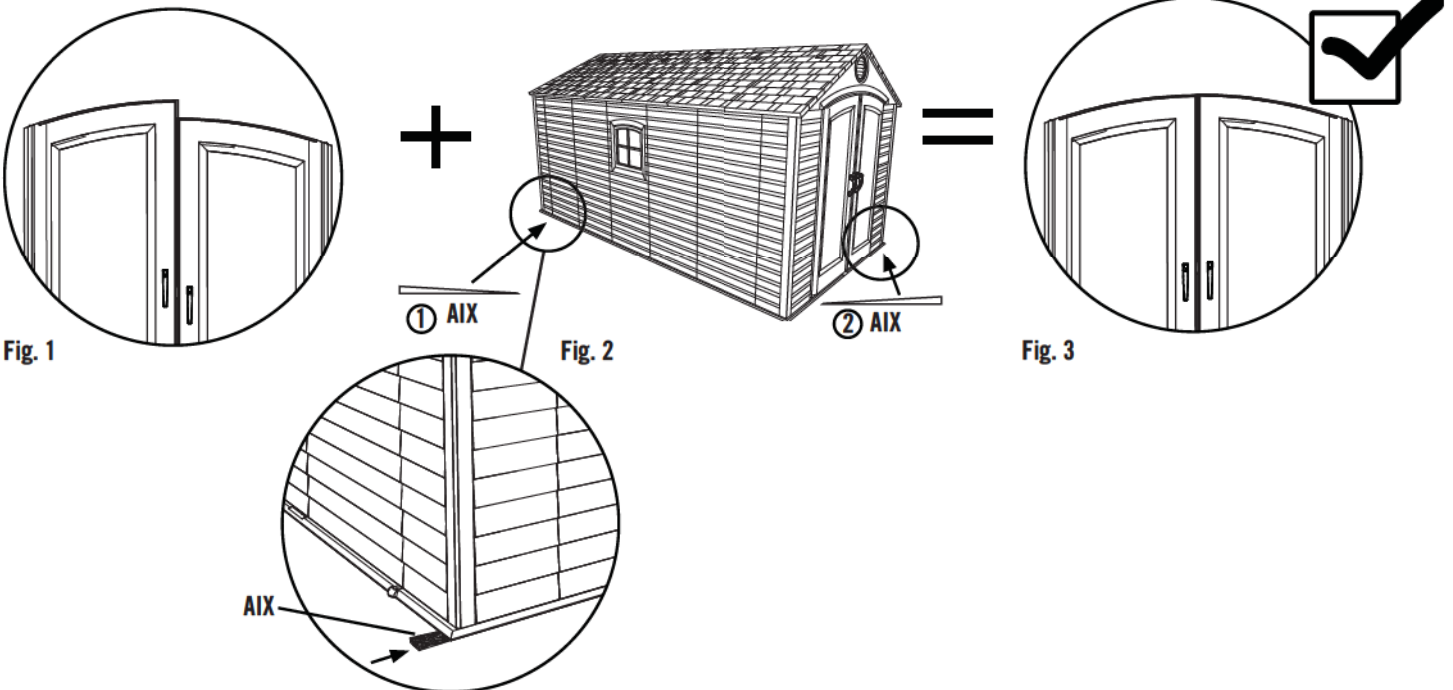

► SECTION 12 (CONTINUED) / SECCIÓN 12 (CONTINUACIÓN) / SECTION 12 (SUITE)

TOOLS AND HARDWARE REQUIRED / INSTRUMENTAL Y HERRAJE REQUERIDOS / OUTILS ET ACCESSOIRES REQUIS



AIX (x4)



12.3

- If the Right Door is higher, insert a **Shim (AIX)** underneath the left, front and right, rear corners of the Shed until the Doors are the same height. **Break off any excess Shim.**
- Si la Puerta derecha es más alta, inserte una **Cuña (AIX)** debajo las esquinas delantera izquierda y trasera derecha hasta que las Puertas queden a la misma altura. **Quebrante cualquier exceso de las Cuñas.**
- Si la Porte droite est plus haute, insérez une **Cale (AIX)** sous les coins avant gauche et arrière droit jusqu'à ce que les Portes restent à la même hauteur. **Détachez de l'excès des Cales.**

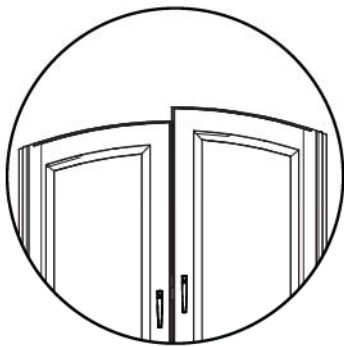

Fig. 1

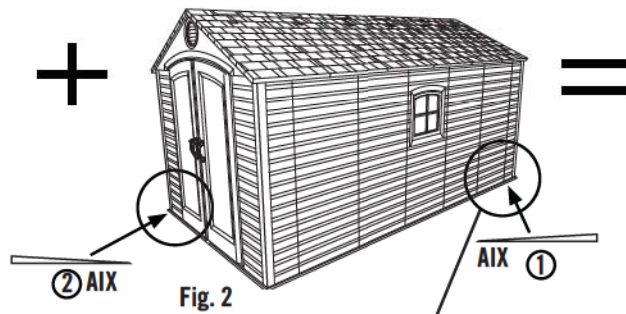

Fig. 2

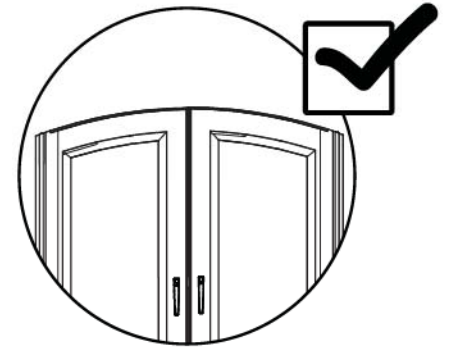
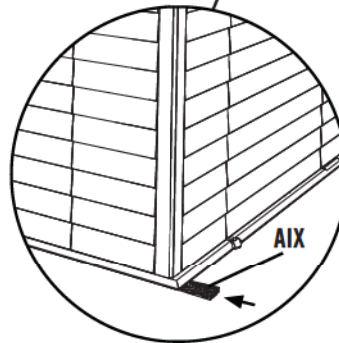

Fig. 3





HARDWARE REQUIRED / HERRAJE REQUERIDO / QUINCAILLERIE REQUISE

NO HARDWARE OR PARTS INCLUDED FOR THIS SECTION
NINGÚN HERRAJE O PIEZA INCLUIDO PARA ESTA SECCIÓN
AUCUNE QUINCAILLERIE OU PIÈCE INCLUSE POUR CETTE SECTION



PARTS REQUIRED / PIEZAS REQUERIDAS / PIÈCES REQUISES

NO HARDWARE OR PARTS INCLUDED FOR THIS SECTION
NINGÚN HERRAJE O PIEZA INCLUIDO PARA ESTA SECCIÓN
AUCUNE QUINCAILLERIE OU PIÈCE INCLUSE POUR CETTE SECTION



TOOLS REQUIRED / INSTRUMENTAL REQUERIDO / OUTILS REQUIS

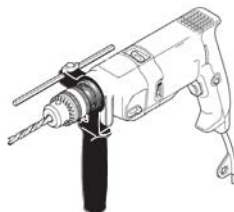

7/16" (11 mm)



 5/16" (8 mm) Wood Drill Bit
 5/16" (8 mm) Broca para madera
 5/16" (8 mm) Foret à bois

 5/16" (8 mm) Masonry Drill Bit
 5/16" (8 mm) Broca para albañilería
 5/16" (8 mm) Foret à maçonnerie

▶ SECTION 13 (CONTINUED) / SECCIÓN 13 (CONTINUACIÓN) / SECTION 13 (SUITE)

FOR A CONCRETE PLATFORM / PARA UNA PLATAFORMA DE CONCRETO / POUR UNE PLATE-FORME EN BÉTON



5/16" (8 mm)

13.1

- To anchor your shed, you must purchase the correct anchoring hardware. **For a concrete platform**, we recommend using a hammer drill, 5/16" (8 mm) masonry bit, twelve (12) 3/8" x 2" (10 mm x 5 cm) Concrete Screws and twelve (12) 3/8" x 1" (10 mm x 2,5 cm) Fender Washers.
- Para anclar el cobertizo, es necesario comprar el herraje de anclaje correcto. **Para una plataforma de concreto**, recomendamos que use un martillo perforador, broca de albañilería de 8 mm (5/16"), doce (12) Tornillos de anclaje para concreto de 10 mm x 5 cm (3/8" x 2") y doce (12) Rondanas de protección de 10 mm x 2,5 cm (3/8" x 1").
- Pour ancrer l'abri, il faut acheter la quincaillerie d'ancrage correcte. **Pour une plate-forme en béton**, nous recommandons que vous utilisiez une perceuse de percussion, un foret à maçonnerie de 8 mm (5/16"), douze (12) Vis d'ancrage à béton de 10 mm x 5 cm (3/8" x 2") et douze (12) Rondelles de protection de 10 mm x 2,5 cm (3/8" x 1").



- Do not exceed a 3/8" (10 mm) diameter screw. Refer to your local hardware store for this hardware.
- No exceda un diámetro de 10 mm (3/8"). Refiérase a su ferretería local para obtener estos elementos.
- Ne dépassez pas un diamètre de 10 mm (3/8"). Votre quincaillerie du coin aura ces accessoires.

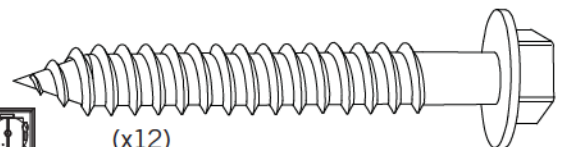
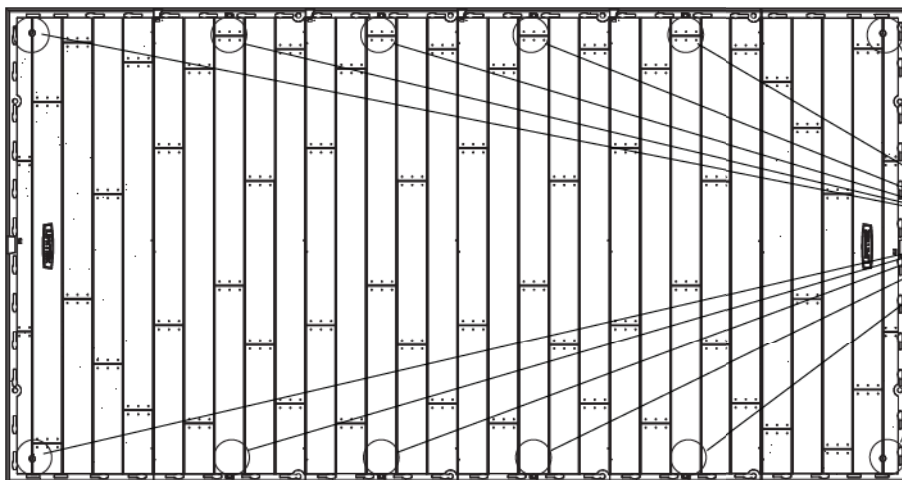

(x12)

(Not included) (No incluidos) (Pas incluses)

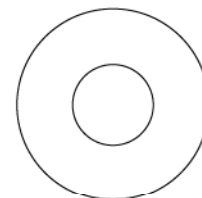

(x12)

(Not included) (No incluidas) (Pas incluses)



- Failure to anchor the shed may result in property damage and/or personal injury.
- El incumplimiento de anclar la caseta podría ocasionar daño a la propiedad y/o lesiones personales.
- Le non-respect d'ancrer l'abri peut résulter en dommage à propriété et/ou blessures graves personnelles.
- シェッドにアンカーを付けない場合は、物的損害や身体傷害が生じる可能性があります。

▶ SECTION 13 (CONTINUED) / SECCIÓN 13 (CONTINUACIÓN) / SECTION 13 (SUITE)

FOR WOOD PLATFORM / PARA UNA PLATAFORMA DE MADERA / POUR UNE PLATE-FORME EN BOIS

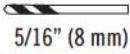

5/16" (8 mm)



7/16" (11 mm)

13.1

- To anchor your shed, you must purchase the correct anchoring hardware. **For a wood-framed platform**, we recommend using a drill, 5/16" (8 mm) drill bit, twelve (12) 3/8" x 1 1/2" (10 mm x 4 cm) Lag Screws and twelve (12) 3/8" x 1" (10 mm x 2,5 cm) Fender Washers.
- Para anclar el cobertizo, es necesario comprar el herraje de anclaje correcto. **Para una plataforma hecho de hecho de madera**, recomendamos que use un taladro eléctrico, una broca de 8 mm (5/16"), doce (12) Tornillos para madera de 10 mm x 4 cm (3/8" x 1 1/2") y doce (12) Rondanas de protección de 10 mm x 2,5 cm (3/8" x 1").
- Pour ancrer l'abri, il faut acheter la quincaillerie d'ancrage correcte. **Pour une plate-forme en bois**, nous recommandons que vous utilisiez une perceuse électrique, un foret de 8 mm (5/16"), douze (12) Vis de retard de 10 mm x 4 cm (3/8" x 1 1/2"), et douze (12) Rondelles de protection de 10 mm x 2,5 cm (3/8" x 1").



- Do not exceed a 3/8" (10 mm) diameter screw. Refer to your local hardware store for this hardware.
- No exceda un diámetro de 10 mm (3/8"). Refiérase a su ferretería local para obtener estos elementos.
- Ne dépassez pas un diamètre de 10 mm (3/8"). Votre quincaillerie du coin aura ces accessoires.

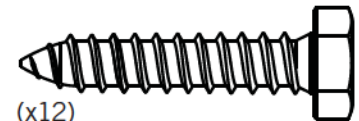
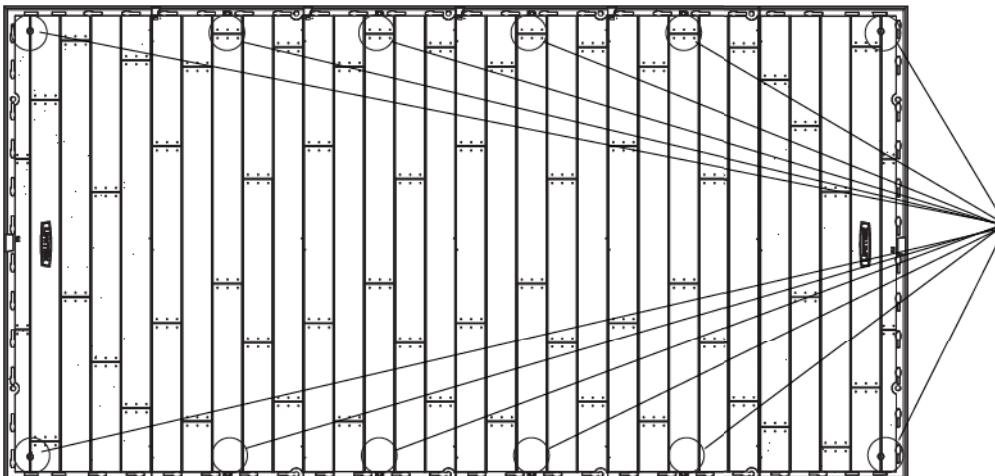

(x12)

(Not included) (No incluidos) (Pas incluses)

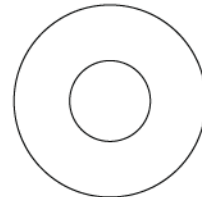

(x12)

(Not included) (No incluidos) (Pas incluses)



- Failure to anchor the shed may result in property damage and/or personal injury.
- El incumplimiento de anclar la caseta podría ocasionar daño a la propiedad y/o lesiones personales.
- Le non-respect d'ancrer l'abri peut résulter en dommage à propriété et/ou blessures graves personnelles.
- シェッドにアンカーを付けない場合は、物的損害や身体傷害が生じる可能性があります。



CLEANING & CARE

Congratulations on your Lifetime® product purchase. By following the instructions below, your new Lifetime product should provide you with years of service and enjoyment.

The polyethylene panels are stain- and solvent-resistant. Most stains can be removed using a mild soap and a soft-bristled brush. Abrasive cleaning materials may scratch the plastic and are not recommended. Repair scratches or rust spots on the metal by sanding the affected area lightly; using a rust preventative spray primer; and finally, spraying with a high-gloss spray enamel paint. Avoid placing a direct heat source on or near surfaces unless using a heat barrier.



LIMPIEZA Y CUIDADO

Felicidades por la compra de su producto Lifetime®. Si cumple todas las instrucciones siguientes, podrá disfrutar satisfactoriamente del servicio de su nuevo producto Lifetime.

Las paredes y los estantes de polietileno son resistentes a las manchas y al solvente. Use para su limpieza un jabón suave y un cepillo de cerdas blandas. Los materiales limpiadores abrasivos podrían raspar el plástico y no son recomendados. Repare las raspaduras o zonas oxidadas de las piezas de metal lijando ligeramente el área afectada; aplique luego una impresión en aerosol para prevenir la formación de óxido; finalmente pinte con un esmalte brillante en aerosol. Evite colocar una fuente directa de calor sobre las superficies o cerca de ellas a menos que use una barrera contra el calor.



NETTOYAGE ET ENTRETIEN

Nous vous félicitons d'avoir acheté ce produit Lifetime®. En suivant les instructions ci-dessous, votre nouvel produit Lifetime devrait vous fournir des années de service et de plaisir.

Les murs et les étagères en polyéthylène sont résistants aux tâches et solvants de nettoyage. Pour les nettoyer, servez-vous d'un savon doux et d'une brosse douce. Les produits abrasifs de nettoyage risquent d'égratigner le plastique et ne sont pas recommandés. Pour réparer les égratignures ou tâches de rouille sur le métal, frottez légèrement l'endroit affecté ou papier de verre, puis passez un couche de produit vaporisant préventif et enfin vaporisez une peinture émail brillant élevé. Évitez de placer une source de chaleur directe sur ou près des surfaces, ou protégez-les à l'aide d'une protection contre la chaleur.



10-YEAR LIMITED FACTORY WARRANTY

THE MANUFACTURER RESERVES THE RIGHT TO MAKE SUBSTITUTIONS TO WARRANTY CLAIMS IF PARTS ARE UNAVAILABLE OR OBSOLETE.

1. Lifetime outdoor sheds are warranted to the original purchaser to be free from defects in material or workmanship for a period of ten years from the date of original retail purchase. The word “defects” is defined as imperfections that impair the use of the product. Defects resulting from misuse, abuse or negligence will void this warranty. This warranty does not cover defects due to improper installation, alteration or accident. This warranty does not cover damage caused by vandalism, rusting, “acts of nature” or any other event beyond the control of the manufacturer.
2. This warranty is nontransferable and is expressly limited to the repair or replacement of defective product. If the product is defective within the terms of this warranty, Lifetime Products, Inc. will repair or replace defective parts at no cost to the purchaser. Shipping charges to and from the factory or distribution center are not covered and are the responsibility of the purchaser. Labor charges and related expenses for removal, installation or replacement of the shed or its components are not covered under this warranty.
3. This warranty does not cover scratching or scuffing of the product that may result from normal usage. In addition, defects resulting from intentional damage, negligence, unreasonable use or hanging from the truss will void this warranty.
4. Liability for incidental or consequential damages is excluded to the extent permitted by law. While every attempt is made to embody the highest degree of safety in all equipment, freedom from injury cannot be guaranteed. The user assumes all risk of injury resulting from the use of this product. All merchandise is sold on this condition, and no representative of the company may waive or change this policy.
5. This product is not intended for institutional or commercial use; Lifetime Products, Inc. does not assume any liability for such use. Institutional or commercial use will void the warranty.
6. Our goods come with guarantees that cannot be excluded under the Australian Consumer Law. You are entitled to a replacement or refund for a major failure and for compensation for any other reasonably foreseeable loss or damage. You are also entitled to have the goods repaired or replaced if the goods fail to be of acceptable quality and the failure does not amount to a major failure.
7. This warranty is expressly in lieu of all other warranties, expressed or implied, including warranties of merchantability or fitness for use to extent permitted by Federal and state law. Neither Lifetime Products, Inc., nor any representative assumes any other liability in connection with this product. This warranty gives you specific legal rights, and you may also have other rights which vary from state to state.