



- Ammunition reloading can be dangerous if done improperly and can result in serious injury or death.
- Reloading rifle ammunition requires extra care due to extremely high pressures. Make sure your cases are in good condition. Inspect them before each reloading for damage and wear. Cases must be trimmed. An excessively long case will pinch the bullet in the end of the rifle chamber and cause dangerously high pressure that could damage your gun and cause personal injury.
- Use only Remington™ or CCI™ primers. Other brands like Federal™, can explode with sufficient force to seriously injure the user or persons nearby. Never place more than 100 primers in the tray.



- Reloading should not be attempted by persons not willing and able to read and follow instructions exactly. Do not permit distractions while loading. This is a complex machine that needs your fullest attention.
- Children should not be permitted to reload ammunition without strict parental supervision.
- Always wear safety glasses and hearing protection when reloading and shooting.
- Ammunition loaded with these tools and data should only be used in modern guns in good condition. We do not accept responsibility for ammunition loaded with these tools or data as we have no control over the manufacture and storage of components or the loading procedure and techniques. Primers and gun powder, like gasoline and matches, can be dangerous if improperly handled or misused.
- Verify proper powder and charge for bullet weight selected.
- Be extremely careful to avoid a double charge. If in doubt, empty the case and recycle it.

WARNING: Handling live primers and spent primers may expose you to lead or other chemicals, which are known to the State of California to cause reproductive harm and cancer.

WARNING: This product may contain steel alloyed with trace amounts of lead and other elements which are known to the State of California to cause reproductive harm and cancer. To prevent exposure, do not alter the product by welding, grinding, etc.

Setup Tools required:

- Safety glasses & ear protection
- 1/2" wrench or socket
- Qty. 2, 7/16" wrench
- # 1 Phillips screwdriver
- 3/16" Hex Wrench

OPTIONAL ACCESSORY:

CASE COLLATOR
90667



PRIMER ATTACHMENT # 90660
FOLDING PRIMER TRAY (1 included) (2-PACK) # 90606

SHELL PLATE CARRIER # TR3975

BASE CASTING # TR3642

PRIMER OUTLET & RETAINING RING # TP3707

RAM PIN # OF3221

PRIMER DISPOSAL TUBE # BP3064
CAP # BP3127

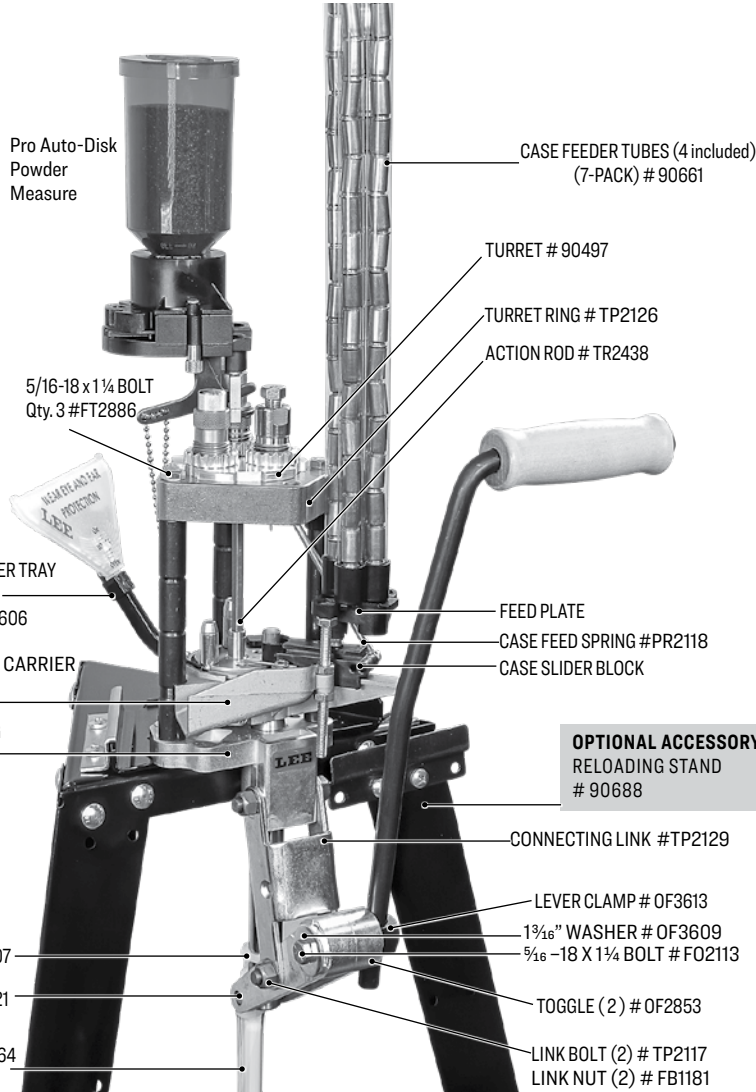

OPTIONAL ACCESSORY:
RELOADING STAND # 90688

LOCK RING WRENCH INCLUDED



Works on Spline Drive Lock Rings and Spline Drive Bushings

LEE BULLET FEEDER OPTIONAL



Automatically feeds bullets into the mouth of the seating die. Aligns bullets more accurately than possible by hand. Increases cyclic rate 50 to 100%.

- 30 & 32 cal. Bullets up to .60 long # 90892
- 9mm through .365 diameter up to .46 long # 90893
- 9mm through .365 diameter .46 to .60 long # 90894
- 9mm through .365 diameter .60 to .75 long # 90895
- 40 cal. through .44 cal. up to .65 long # 90896
- 40 cal through .44 cal .65 to .80 long # 90897
- 45 cal. bullets .50 to .67 long # 90898

TR2441

Lubricate these points often, household oil works well:

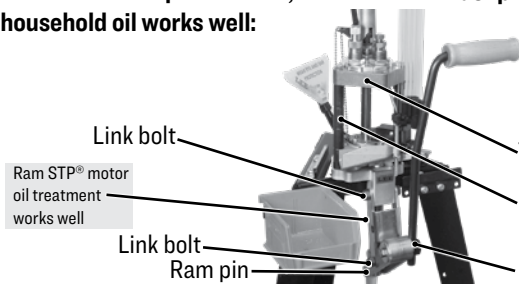

Rust proof these points often:

Dry Coat® rust preventative works well

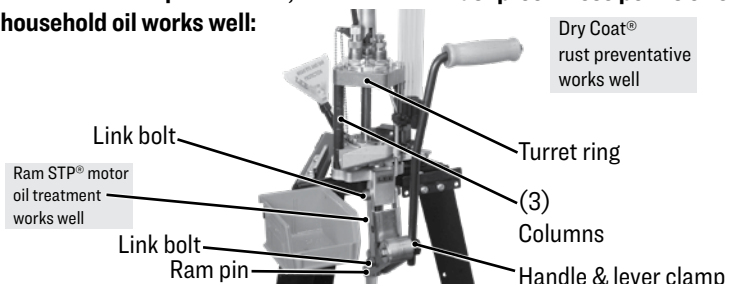

- 1** Mount your press. The most convenient way to mount your press is with our **Lee Bench Plate System # 90251**. This system includes all of the mounting hardware and allows for quick press removal without unbolting from bench. Or, purchase (qty. 3) 1/4" bolts and nuts and prepare your workbench for use with this press using the drill template available.

On workbenches where front edge is flush with cabinet or drawer below, mount the base plate 1/2" minimum over the front edge of the bench to provide clearance for the spent primer disposal tube.

90251 Bench Plate

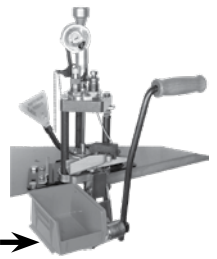

For added convenience in catching completed rounds, consider the **bin and bracket # 90687**.

- 2** Attach the handle with **[FIG 1]** clamp assembly.

FIG 1

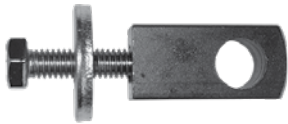

- [FIG 2]** Slide handle clamp assembly into toggle and orientate hole in lever clamp with radius in toggle.

FIG 2

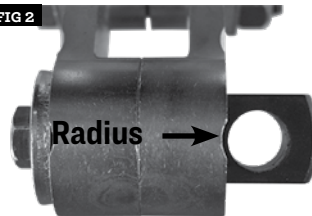

- [FIG 3]** Slide in the roller handle into the lever clamp assembly, make sure the handle passes completely through as shown.

FIG 3

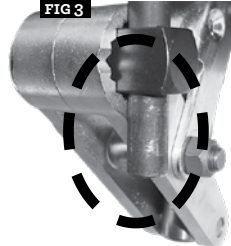

- [FIG 4]** Snug bolt with a 1/2" socket or wrench, tighten securely to 25 ft./lbs. minimum.

FIG 4

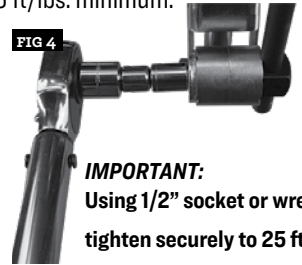

IMPORTANT: Using 1/2" socket or wrench, tighten securely to 25 ft./lbs.

- 3** Raise the retaining ring and slide the primer collection tube assembly into the ram. Slide retaining ring on to assembly.

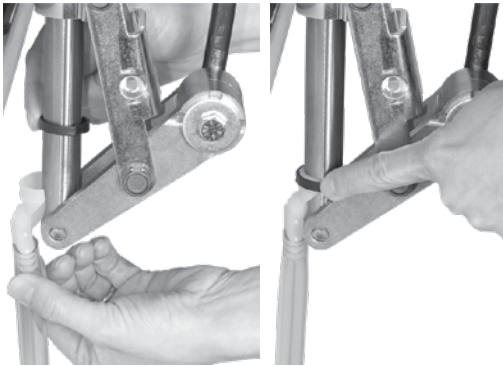

4 SAFETY CONSIDERATIONS

- Use only Remington™ or CCI™ primers. Other brands, especially Federal™, can explode with sufficient force to seriously injure the user or persons nearby. Never place more than 100 primers in the tray.
- Be sure of proper powder and charge for bullet weight selected.
- Wear safety glasses and hearing protection when reloading or shooting.
- Be extremely careful to avoid a double charge. If in doubt, empty the case and recycle it.
- Do not permit distractions while loading. This is a complex machine that needs your fullest attention.

SMOOTH OPERATING TIPS

- Oil ram using STP™ motor oil treatment. Using any oil, lubricate link bolts and ram pin every few thousand rounds.
- Don't let the primer level fall below the tray level. Running out of primers will cause a jam.
- Always move the lever smoothly in complete strokes. An interrupted stroke can cause a jam or double charge.
- Do not force it or you will break something. If it does not feel right, stop and check out the problem.
- Polish the chute with steel wool and wax or Lee Resizing Lubricant to help loaded rounds slide into your container.

- 5 DRY RUN (NO PRIMERS, POWDER OR BULLET)**
Cycle the lever up and down to confirm the shell plate is advancing correctly.

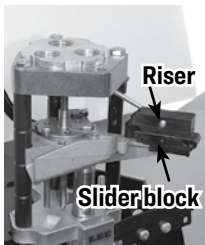

Lower the lever, place a case in front of the **slider block** and raise lever to insert case into shell plate. Lower the lever and the case is raised into the sizing die position. Lift the lever, the case will advance to the priming station and primer will be seated at the carrier's bottom of the stroke. Lower the lever, the case will rise into station #2, the powder charging and pistol expanding station. Raise the lever and the case will advance to bullet seating/crimping station # 3. Lowering the lever will raise the case into the bullet seating/crimping die to seat the bullet.

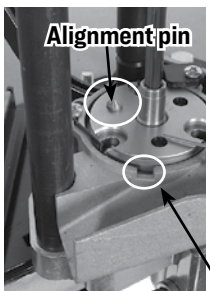

At any time if you want to remove the case, raise the shell plate carrier so that the **alignment pin** is no longer engaged with the shell plate, you can then rotate the shell plate in either direction to remove the case. Important, if a partially seated primer holds the case in the shell plate, simply rotate the shell plate to the high primer ejection slot and remove. Whenever the normal reloading sequence is interrupted, the most important hazard to guard against is a double charge. It is always best to completely remove the offending case.

high primer ejection slot

TURRET POSITIONS

Never adjust dies in position # 2 or # 3 to contact the shell plate, or damage to the shell plate carrier will occur.

Powder Through Expanding Die or Rifle Charging Die

position 2

position 1

Sizing Die

position 3

Bullet Seat and Crimp Die

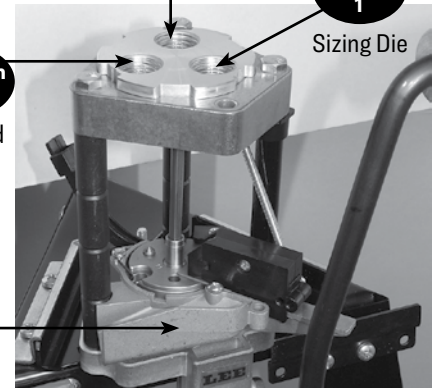

Shell Plate Carrier

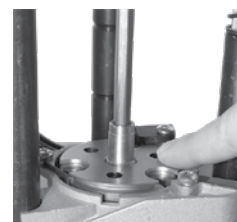

Should the shell plate get out of time, disengage the ratchet by raising the shell plate carrier 1/4" and advance the shell plate by hand.

6

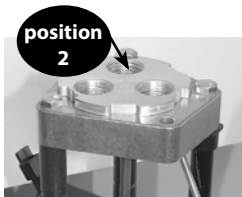

FIG 5



Powder Through Expanding Die

Handgun Powder Through Expanding die (position # 2)

[FIG 5] Spin the lock-ring up to the top of the powder through expanding die. Install powder measure into die. Lower the press lever (shell plate carrier raised). Install powder measure assembly into turret position # 2. Thread assembly in until it touches the shell plate, then back out one full turn. [FIG 6] Insert a case into the shell plate and align the shell with turret position # 2. Raise the case into the power through expanding die to flare the case mouth. Lower the shell plate carrier enough so that you can check the amount of flare. [FIG 7] Use your bullet as a gauge. Flare enough so that the bullet easily starts into the case. Flare is increased by turning the die clockwise (closer to the shell plate). Continue short cycling the press lever until you've achieved the desired flare, finger tighten the die lock-ring.

OR



Rifle Charging Die

Rifle Short Charging Die (position # 2)

This die only ships inside the 223 Remington Pro 1000
Spin the lock-ring up to the top of the rifle short charging die. [FIG 8] Thread charging die on to Auto-Drum knurled adapter completely. Install assembly two full turns into the turret in position # 2. Insert a case into position # 2. Lower press lever (shell plate carrier up). Screw the powder measure assembly into the press until the case actuates the powder measure [FIG 9] slider drop tube rises and activates the powder measure.

Dispense position
Note: slider drop tube should not make contact with top of slot

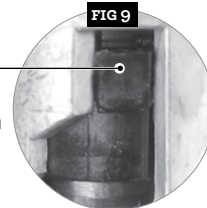
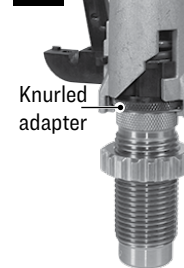

FIG 8



Knurled adapter

Consult your powder measure instructions and reloading die instructions for setting the charge on your Auto-Drum instructions pg. 2

7

PRO AUTO-DISK



Knurled adapter

FIG 10

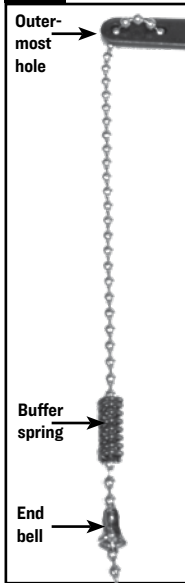

Outer-most hole

Buffer spring

End bell

PRO AUTO-DISK

Loosen the black knurled adapter on the powder measure and orientate the measure so the pull back lever aligns with the shell plate carrier hole, then tighten the knurled adapter.

[FIG 10] Attach end bell 5 beads from the end of the chain. Place the buffer spring on top of the end bell. Feed the chain through the hole on the shell plate carrier. With the shell plate carrier in the **down** position, thread the chain through the outer-most hole in the Pro Auto-Disk actuator lever. Raise the shell plate carrier slightly and pass one additional bead through the hole. Lower shell plate carrier, the chain should be taut. Pass the remaining chain through the inner most hole of the Pro Auto-Disk actuator lever. The **case will actuate** the powder measure and the bead chain will return the powder measure for the next charge. **Consult your powder measure instructions and reloading die instructions for setting the charge.**

8 BULLET SEATING DIE (position # 3)

position 3

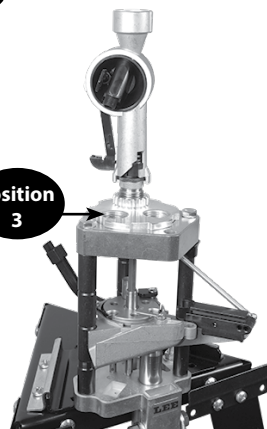

Spin the lock-ring up to the top of the die and unscrew the adjusting screw out five full turns. Put the press lever in the up position (shell plate carrier down). Place a loaded round that you wish to duplicate in turret position # 3. [FIG 11] Raise the shell plate carrier to the top of its stroke and hold (shell plate carrier up). Screw the bullet seating die in until it stops turning, lower the shell plate carrier slightly, thread die in an additional 1/8 turn. Finger tighten the lock ring. Now raise the shell plate carrier to the top of its stroke, screw the bullet seating adjusting screw in until you feel it touch the tip of the bullet.



FIG 11



9 Full Length Sizing Die (position # 1)



Lower the press lever (shell plate carrier up).

Screw the full length sizer in to position # 1 until it touches the shell plate, lower the shell plate carrier, screw the die in an additional ¼ turn. Raise the shell plate carrier and tighten the lock ring finger tight.

Consult your powder measure instructions and reloading die instructions for setting the charge on your (Auto-Drum Powder Measure, instructions pg. 2) or (Pro Auto-Disk Powder Measure, back side of instruction sheet)

10 Fill the primer feed tray.

Don't let the primer level fall below the tray level. Running out of primers will cause a mess inside your shell plate carrier. Once the last primer has exited the folding tray, replenish the primer supply, else you will load cases without primers.

DANGER: Use only CCI™ or Remington™ brand primers. Other brands, especially Federal™, can explode with sufficient force to seriously injure the user or persons nearby.

ALL PRIMERS ARE DANGEROUS and it should be anticipated that the primers in the tray could explode through accident, misuse or spontaneously. Should an explosion occur, our tests have demonstrated that safety glasses will normally prevent serious injury to the user if CCI™ or Remington™ primers are used, because the explosion is minimal. Other primers, however, can explode with sufficient force to seriously injure the user, or persons nearby. We do not take any position with respect to the quality of performance of primers available on the market. However, ONLY those primers manufactured by CCI™ or Remington™ are recommended for use in the Pro 1000—and when loading those primers—safety glasses and hearing protection must be used. NO OTHER PRIMERS should be used with the Pro 1000.

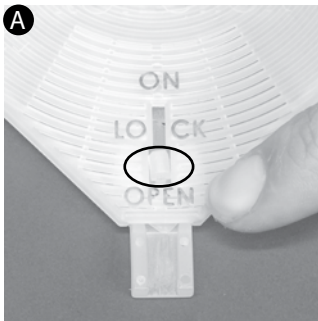

Slide the flow control to **OPEN**.

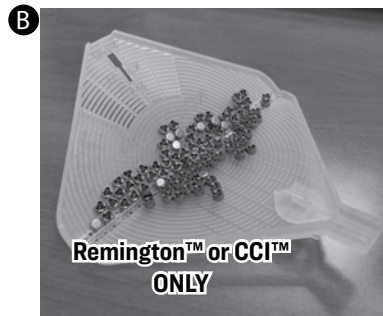

Randomly deposit primers.

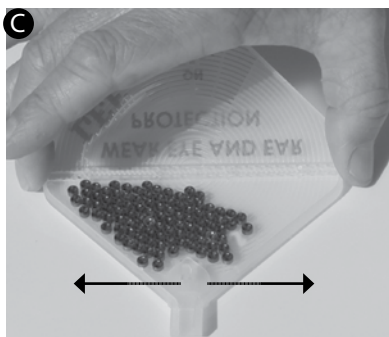

Lift tray so output spout touches table, shake tray side to side to upright all the primers. Allow cover to naturally fold up, notice how the primers glide across hinge upright themselves and work their way to wards the outlet.



Fold cover over, slide the flow control to **LOCK** position, feel for the detent. Grasp the top and bottom of the flow control valve using your thumb and index finger above and below tray. **NOTE: make sure it is in the LOCK detent position, else primers may spill.**

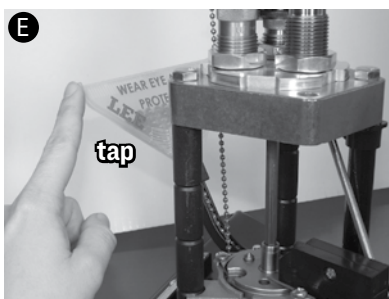

Slide the tray into the trough. Slide the flow control to the **ON** position. Tap the side of the tray several times to fill the trough.



WARNING: Handling live primers and spent primers may expose you to lead or other chemicals, which are known to the State of California to cause reproductive harm and cancer.

11

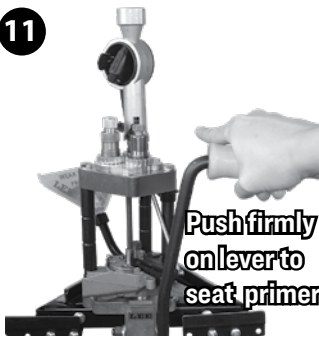

Before attaching the 4 tube case feeder, place an empty case in front of the case slider. Process 50-100 cases until you have the feel of the entire reloading sequence. Be sure to measure your completed ammunition to verify it is the correct overall length and will chamber in your firearm.

IMPORTANT: the primer is seated during the last inch of lever travel. Make a conscious effort to feel the primer enter and fully seat into the case. Incomplete primer seating will not allow the case to eject from the shell plate. This seems to be the biggest problem for first time users. A loose shell plate carrier socket head screw may prevent proper seating of primers.

12

Install the case slider block and feed plate
Remove slider block from carrier tongue by unscrewing the Phillips screw on the riser and releasing the spring. Raise the shell plate carrier to the top of the stroke. [FIG 12] Insert case on carrier tongue. Place a coin on top of the case. Slide feed plate assembly into the carrier hole, and adjust the top nut so that the bottom of the feed plate assembly rests on top of the coin. Tighten the nuts using two 7/16" wrenches.

[FIG 13] Re-install slider block and/or riser as shown. Screw with spring goes in rear hole. Install 4 clear case feed tubes and load with cases.



ACCESSORY
CASE COLLATOR
90667
Fills all four tubes in just ten seconds.

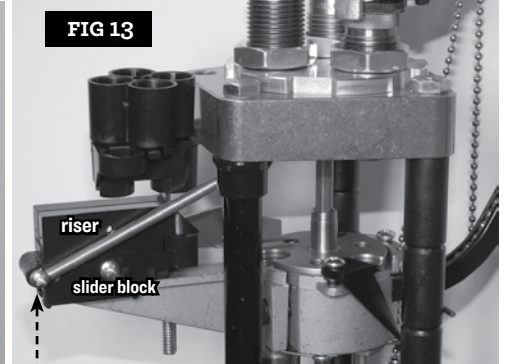
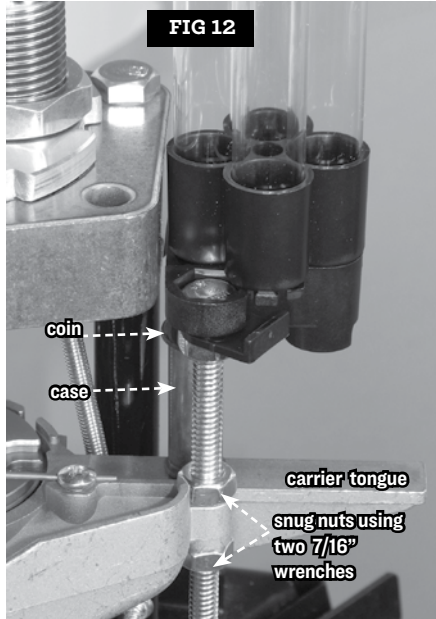

USE REAR HOLE

See chart on page 8. Some cases require riser to be installed on top of case slider block.



Slide the **RISER** block on top of **CASE SLIDER BLOCK** until the front and back are flush. Tighten Phillips screw on riser block.

TROUBLESHOOTING

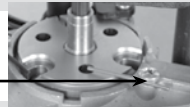
PROBLEM	CAUSE	REMEDY
Primers not fully seated	Operator not lifting hard enough	Learn to feel the primer seating when the lever is pushed up.
	Shell plate carrier not fully seated, or loose on ram	Loosen socket head cap screw and force shell plate carrier on the ram. Re-tighten clamp screw.
	Obstruction to full travel	Check for primer on base or under shell plate carrier. Carrier should contact the base with no case in the shell holder.
Primer doesn't feed onto priming punch	Oil or gunpowder in trough	Remove all oil with solvent or blow out powder or dust with compressed air.
	Primer trough not full	Always keep primer trough full.
Primer doesn't enter case	Primer crimp not removed	Ream or swage primer pocket.
	Wrong size primer	Caution, some 45 ACP cases now have small primer pockets
Tipped primers	Case not fully in shell plate	Clean shell plate. Check tension finger. Straighten or replace tension finger as required.
	Spilled powder in primer trough	Clean powder out with compressed air.
Cases don't eject	Primers not fully seated	See "Primers not fully seated" problem above.
	Cases wedge against ejector pin	Move ejector pin to other side of screw. 
Case feeder doesn't work properly	Case feed spring in wrong case slider hole	See case feed spring orientation photo below. Spring should be installed into rear hole.

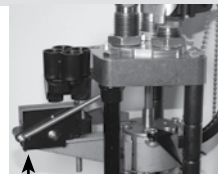

case feed spring orientation

CHANGING SHELL PLATE ONLY

A With your case slider block removed, and shell plate carrier at mid-stroke position, loosen Phillips screw that holds the case ejector and remove ejector. **DO NOT LOSE IT!**

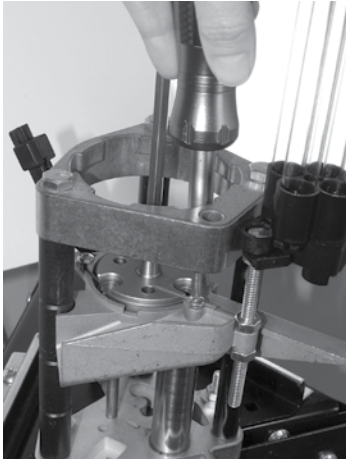

B Lower carrier so carrier pin passes through shell plate to prevent shell plate from rotating. Loosen the drive bolt by rotating the action rod **clockwise** with a 1/4" nut driver.

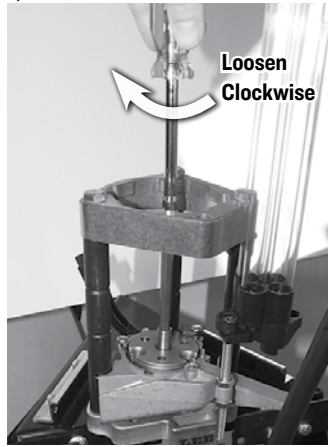

C Remove the trough and priming pin and clean out any accumulated primer dust or powder. Install correct (**small or large**) primer trough and primer pin before installing a new shell plate.

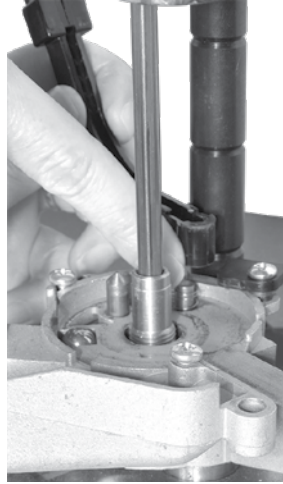

D Install shell plate and tighten the drive bolt by rotating the action rod **counterclockwise**. Re-adjust the zero index as explained under "Zero Adjustment" below.

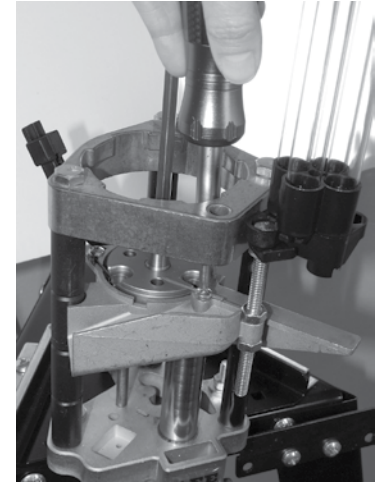

ZERO ADJUSTMENT FOR SHELL PLATE INDEXING

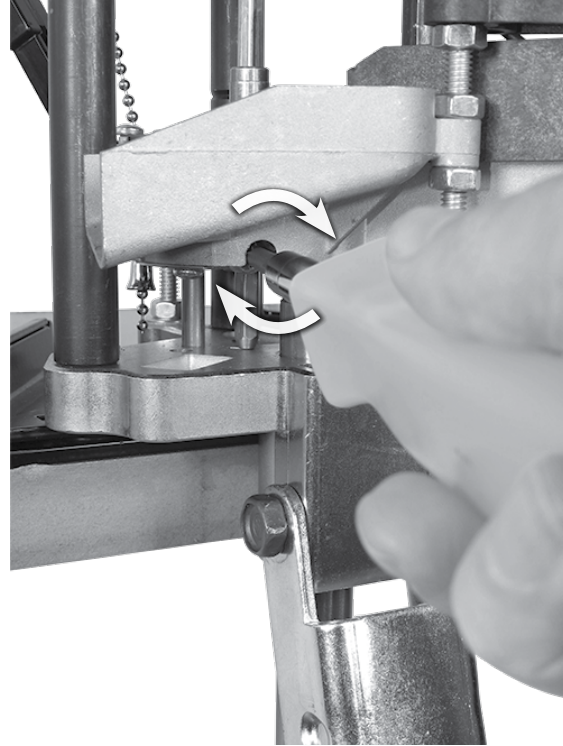
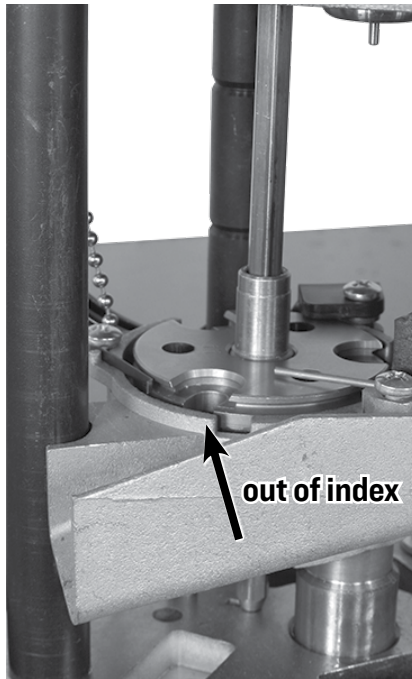

Raise and lower the shell plate carrier, if the alignment pin does not pass through the shell plate it is out of index. Raise and lower the shell plate carrier again. Rotate the Phillips adjusting screw clockwise until the shell plate snaps into position. If the alignment pin is projecting through the shell plate, your index is set. Do not continue to rotate the screw, you'll strip out the ratchet gear.

Proper index, alignment pin passes through shell plate

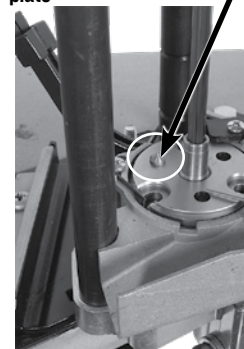

CHANGING THE SHELL PLATE CARRIER

Remove turret, primer tray, z-bar and case slider block.

A Loosen 3/16" socket head screw. **B** Place wood block under carrier and pull up on handle to lower ram.

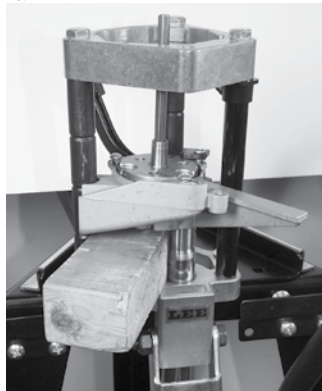
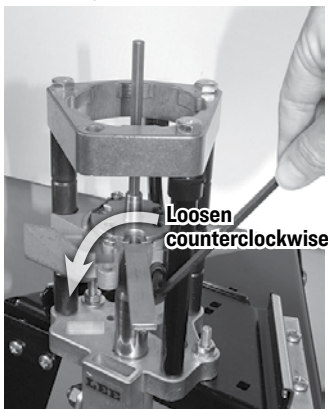

C Push down the action rod towards base approx. 2 inches to ease in removal.

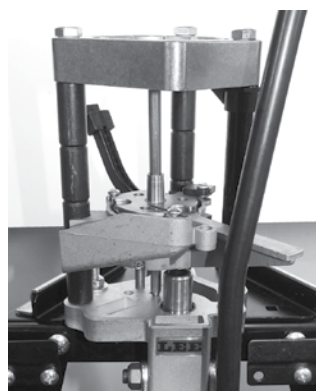

D Rotate and remove shell plate carrier.

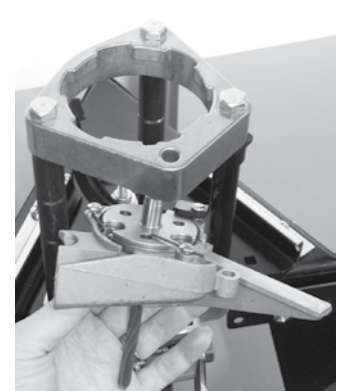

INSTALLING THE SHELL PLATE CARRIER

The carrier is attached to the ram with a single socket head screw. This makes it very easy to change the entire carrier for caliber changing.

- A** Push the action rod through the carrier from the bottom side until the end slightly protrudes through the top. Be sure the twisted end is down.

- B** Be sure to keep the primer trough pin behind the right rear column. Push the assembly onto the ram's end.

- C** Re-install turret with dies and raise your carrier to completely seat it on to the ram. Tighten the carrier socket head screw with a 3/16" hex wrench.

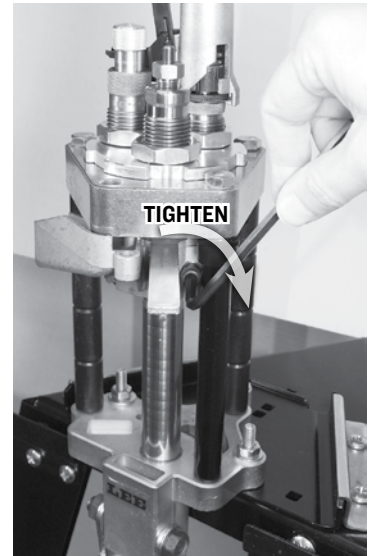
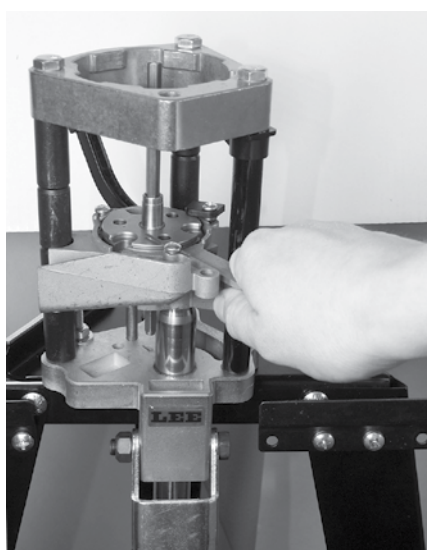
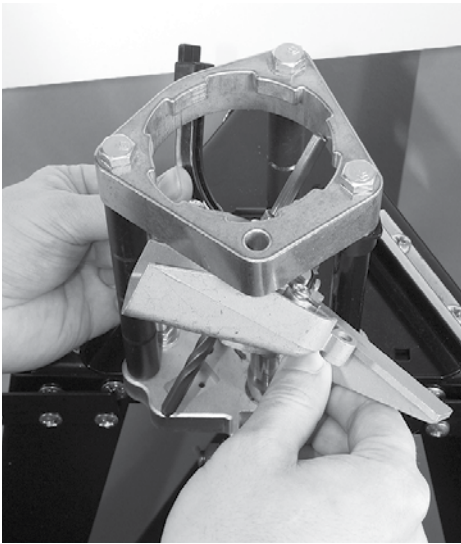

SHELL PLATE PARTS LIST

When changing calibers that use a different primer size, we recommend changing the entire shell plate carrier. If caliber uses the same primer size, you can easily change just the shell plate.

TR3975 Carrier

TR2436 Primer Pin, Large
TR2437 Primer Pin, Small
TR2479 Primer Spring

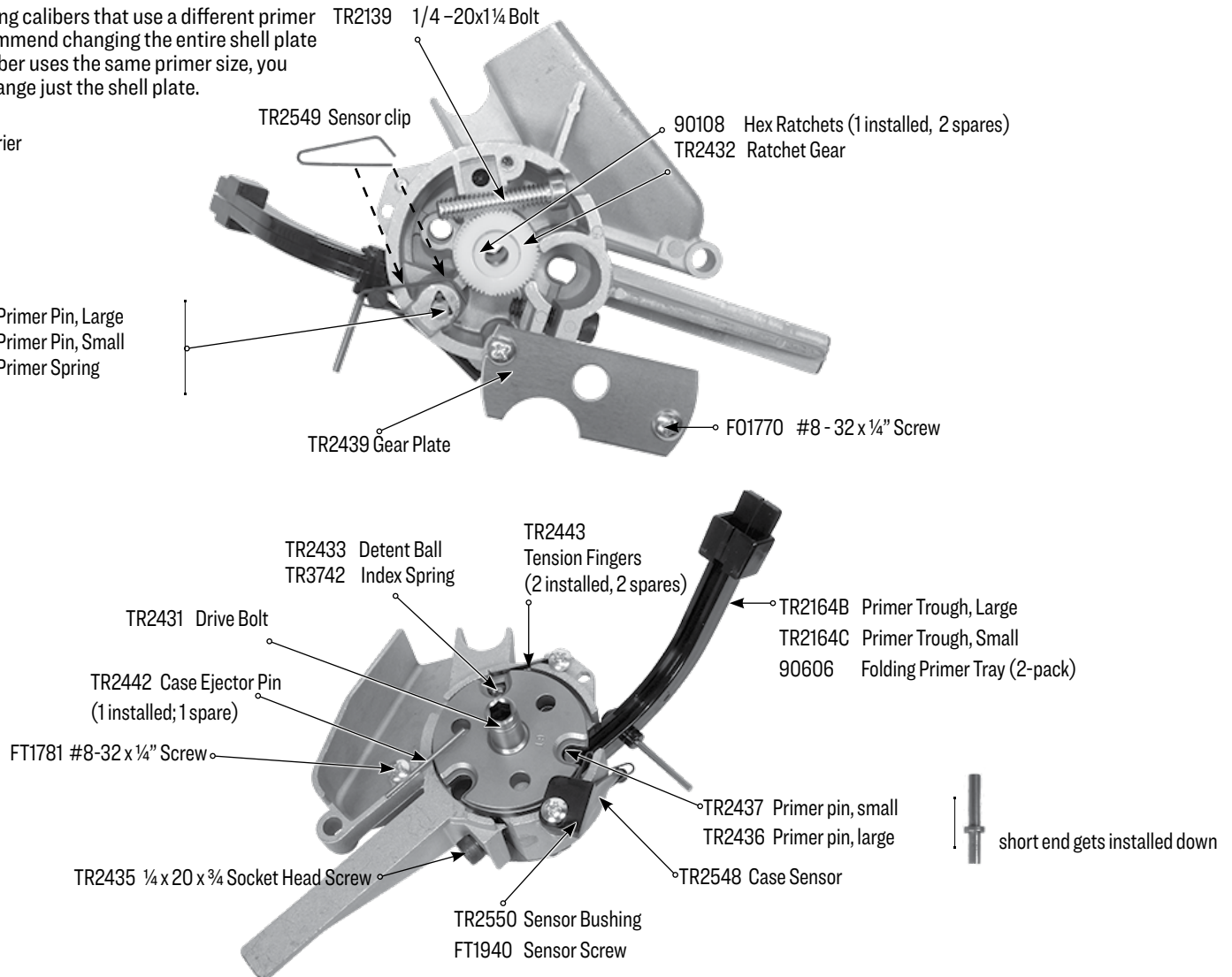

CHANGING CARTRIDGE SETUP

To convert the Pro-1000 from a one cartridge to another, you will need the proper shell plate, primer trough and primer pin (# 90660 primer attachment), and appropriate Lee reloading die set. The chart below shows proper configuration with catalog numbers. Identify your current press configuration by cartridge. The chart will list which components shipped with your press (primer feed, shell plate). Then check the cartridge you wish to load, to see which components match with your current press configuration. Order any components that do not match (primer feed and shell plate).

CARTRIDGE	SHELL PLATE NUMBER	SHELL PLATE ONLY	PRIMER FEED	FEED PLATE HOLE SIZE	SLIDER BLOCK	RELOADING DIES	CHARGING DIE	POWDER MEASURE
30 Luger	19	90669	SMALL	SMALL		90754		PRO AUTO-DISK
30 Mauser	19	90669	SMALL	SMALL		90755		PRO AUTO-DISK
7.62 Tokarev	19	90669	LARGE	SMALL		90769		PRO AUTO-DISK
32 ACP	7	90655	SMALL	SMALL		90622		AUTO-DRUM
32 S&W Long	4	90653	SMALL	SMALL		90624		AUTO-DRUM
32 H&R MAG / 327 FED	4	90653	SMALL	SMALL		90809		AUTO-DRUM
9mm Luger	19	90669	SMALL	SMALL		90332		PRO AUT- DISK
9mm Makarov	19	90669	SMALL	SMALL		90176		AUTO-DRUM
32/20	6	90976	SMALL	N/A	N/A	90751		AUTO-DRUM
357 Sig	19	90669	SMALL	SMALL		90270		PRO AUTO-DISK
38 Super	19	90669	SMALL	SMALL		90623		PRO AUTO-DISK
38 S&W	1	90651	SMALL	SMALL		90569		AUTO-DRUM
380 Auto	4	90653	SMALL	SMALL		90092		AUTO-DRUM
38 SPL & 357 MAG	1	90651	SMALL	SMALL	RISER	90615		PRO AUTO-DISK
38 ACP	19	90669	SMALL	SMALL		90623		PRO AUTO-DISK
38 Short/Long COLT	1	90651	SMALL	SMALL		90276		AUTO-DRUM
40 S&W	19	90669	SMALL	SMALL		90571		PRO AUTO-DISK
10mm Auto	19	90669	LARGE	SMALL		90566		PRO AUTO-DISK
41 Mag	9	90656	LARGE	LARGE	RISER	90628		PRO AUTO-DISK
44 SPL & 44 MAG	11	90657	LARGE	LARGE	RISER	90604		PRO AUTO-DISK
400 Cor Bon	2	90652	LARGE	LARGE		90430		AUTO-DRUM
30M1	7	90655	SMALL	SMALL	RISER	90626		AUTO-DRUM
44 Russian	11	90657	LARGE	LARGE	RISER	90293		AUTO-DRUM
44-40 WIN	14	90065	LARGE	LARGE	RISER	90564		PRO AUTO-DISK
454 Casull	11	90657	SMALL	LARGE	RISER	90795		AUTO-DRUM
45 ACP	2	90652	SMALL OR LARGE	LARGE		90233		PRO AUTO-DISK
45 Auto Rim	13	90665	LARGE	LARGE		90808		PRO AUTO-DISK
45 Colt	11	90657	LARGE	LARGE	RISER	90265		PRO AUTO-DISK
45 Schofield	14	90065	LARGE	LARGE	RISER	90323		PRO AUTO-DISK
45 GAP	2	90652	LARGE	LARGE		90498		PRO AUTO-DISK
45 WIN MAG	3	90664	LARGE	LARGE	RISER	90810		AUTO-DRUM
460 S&W	14	90065	LARGE	LARGE	RISER	90344		AUTO-DRUM
50 Action Express	11	90657	LARGE	N/A	N/A	90329 (LUBE REQ.)		AUTO-DRUM
223 REM	4	90653	SMALL	SMALL	RISER	90253 (LUBE REQ.)	90668	AUTO-DRUM
7.62 x 39	12	90666	LARGE	SMALL	RISER	90565 (LUBE REQ.)	90668	AUTO-DRUM
222 REM	4	90653	SMALL	SMALL	RISER	90501 (LUBE REQ.)	90668	AUTO-DRUM
458 SOCOM	2	90652	LARGE	N/A	N/A	90409 (LUBE REQ.)		AUTO-DRUM

N/A = Not available LUBE REQ. = # 90006 LEE resizing lubricant required

PRO AUTO-DISK # 90429

AUTO-DRUM # 90811

PREVIOUS PRO 1000 OWNER?

Your previously purchased shell plates will work on this new press if they have three through holes, and your carrier is the "NEW" version.



To utilize your old shell plates, your press alignment pin must be removed. Remove the press from your bench, use a plastic mallet and drive the pin through the base.

OLD

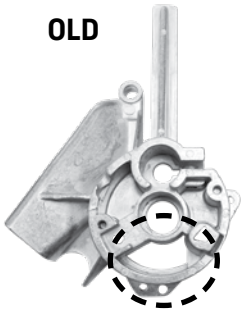

NEW

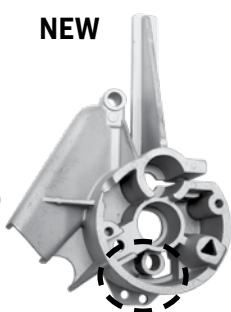

Assembled as **SMALL** feed plate

Bolt and nuts are adjacent to small through hole and the small plug.



Assembled as **LARGE** feed plate



storage spot for small plug



Learn more about reloading we have.