



**WTC**®

**LEAPERS, INC.**®

**2019 CATALOG**

# LEAPERS®, INC.

## A GLOBAL ORGANIZATION



### COMPANY INTRO

What once started in 1992 out of a garage is now an international business that spans the globe with manufacturing and distribution facilities in four different countries. Leapers, Inc. develops, manufactures, and distributes a wide array of practically innovative hunting and shooting sports oriented products. After 27 years of hard work and dedication, our company headquarters consists of a 3-building complex with over 150,000 square feet of space located in Livonia, Michigan. Fully equipped and staffed to accomplish our very own in-house product design, development, manufacturing, order fulfillment and distribution, our UTG® and UTG PRO® brands have gained wide spread recognition with a loyal customer base around the globe. We continue to dedicate our efforts to promote and uphold the hunting and shooting sports lifestyle. As of mid-2018, we expanded, yet again, internationally, with the installment of our UTG Taiwan Manufacturing Center. With this expansion we ultimately aspire to provide complete and total solutions for more customers internationally around the globe for all of their hunting and shooting needs.

### MISSION STATEMENT

Our mission is to offer innovative, quality, valued, and solution-oriented products with complete concept-to-delivery services to customers everywhere possible around the globe.

## UTG TAIWAN



The Leapers, Inc. global organization with its integrated R&D, production, and distribution aims to sow the seed of its unique business culture in Taiwan and to further invest in people, process, and technology. UTG Taiwan will provide our loyal customers around the world with complete and total solutions and a new age team of determined and knowledgeable individuals ready to further uphold the shooting sports and outdoor lifestyle. Across the globe more individuals are embracing and finding enjoyment in shooting sports. Reaching these international customers and providing them with the same level of support and enjoyment we have here domestically is our ultimate goal. **[Also Refer to P. 6]**

## UTG PRO EXPANSION



Our UTG PRO® USA Manufacturing continues to push forward in meeting and answering customer feedback by further investing in our infrastructure, manufacturing capability, and technology. After expanding the manufacturing floor to accept recently acquired Miyano 9-axis CNC Super Turning Centers, we are now better equipped to design, engineer, and manufacture in larger capacities the feature driven products customers demand. **[Also Refer to P. 5]**

## LIFETIME WARRANTY



Leapers, Inc. warrants that all UTG® and UTG PRO® products conform to published specifications and are free from defects in material and workmanship. We will repair or replace defective products for the duration of the product's lifespan. Our dedicated in-house customer service professionals will provide the best-in-class service and support with the highest level of integrity and care.

**LEAPERS, INC.**  
**THE BEST NEVER REST**  
**LIFETIME WARRANTY**

<b>OPTICS</b>	Accushot® OP3 Series .....020
	Accushot® Premium Series .....022
	Accushot® Precision Series .....024
	Accushot® Scouting Series .....026
	Accushot® T8 Tactical Series .....028
	Accushot® T4 Tactical Series .....030
	Accushot® Tactical Series .....032
	Bugbuster™ Series .....034
	True Hunter™ IE® Series .....036
	True Hunter™ Classic Series .....038
	Reflex Sights & Magnifier .....040
	Dot Sight Series .....042
	Air Rifle Scopes & Accessories .....044
	Crossbow & Handgun Scopes .....046
	Scope Accessories .....047
<b>RING MOUNTS</b>	
	Accu-Sync® Scope Rings .....050
	P.O.I® Scope Rings .....052
	Max Strength™ Scope Rings .....054
	Accushot® Scope Rings .....056
	Precision Steel Scope Rings .....058
	Flashlight/Laser/Magnifier Rings .....059
<b>MOUNTING SYSTEMS</b>	
	MR556/G3 Handguards .....064
	Ruger Precision Rifle® Handguards .....065
	AR15 Handguards .....066
	AR308 Handguards .....078
	Riser Mounts .....084
	Micro Gas Blocks .....088
	Other AR15 Mounts .....089
	AK Handguards & Mounts .....090
	SKS/Mosin Mounts .....094
	Shotgun Mounts .....095
	M14, M1C, 10/22, Bolt Action Mounts .....096
	MP5, G3, G36 Mounts .....097
	Angle/Barrel Mounts .....098
	Air Rifle Mounts .....099
<b>BIPODS &amp; SHOOTING STANDS</b>	
	TBNR™ Bipods .....102
	Over Bore Bipod .....104
	Full Stability Bipod .....105
	Recon Series Bipods .....106
	D-Grip .....109
	Rubber Armored QD Bipod .....110
	Tactical OP Bipods .....111
	Shooter's Bipods .....112
	Barrel Clamp Bipods & Shooting Stand .....113
<b>FLASHLIGHTS AND LASERS</b>	
	Grip Light Series .....118
	Pistol Series .....120
	Vanquish 700 Series .....121
	Multi-purpose Series .....122
	Green Lasers .....124
	Red Lasers .....125
	Flashlight/Laser Combos .....126
	Flashlight and Laser Accessories .....127
<b>ACCESSORIES AND PARTS</b>	
	Pistol Accessories .....130
	AR15/AR308 Butt Stocks and Accessories .....132
	Iron Sights and Sight Tools .....140
	AR15 Components .....144
	Magazines .....146
	AR15 and AR308 Wrenches .....147
	Foregrips, Index Mounts, and Handstops .....148
	Pistol Grips and Panel Covers .....152
	AK/SKS Accessories .....154
	QD Sling Swivel and Sling Swivel Adaptors .....156
	M-LOK® and Keymod Accessories .....158
	Broken Shell Extractors and Other Accessories .....160
	Cleaning Kits .....161
<b>GUN CASES</b>	
	ABC Series .....164
	MC Series .....166
	KIS Gun Case .....167
	DC Series .....168
	RC Series .....169
	Pistol Cases .....170
<b>TACTICAL GEAR</b>	
	Bags and Packs .....174
	Range Bags .....178
	Vests .....180
	Rifle Slings .....184
	Holsters .....186
	Belts .....190
	Range and Maintenance Gear .....191



# UTG WORLD HQ USA

WORLD HEADQUARTERS



Providing a one-stop shopping experience requires seeing the whole picture from concept to delivery. Customers receive a wide variety of innovative products to choose from, designed and prototyped entirely in-house and backed by our very own graphics design team, customer service department, and individually assigned sales representatives. They also receive the care and attention to detail when it comes to their individual order fulfillment. Receiving the correct products and quantities, undamaged out-of-the-box, in a timely manner requires a world-class order fulfillment center capable of high volume turnaround and direct-to-consumer drop shipping. Like our products, we strive to constantly improve our business practices to better our services and have switched to environmentally friendly, energy saving, and resource efficient operations with the use of wireless and paperless fulfillment procedures, gravity-fed pallet flow racks, motion-sensor-controlled conveyors and lighting, and space maximized shipping carton algorithms. UTG® World HQ has the technology, the staff, and the commitment to excellence to provide our customers with the personal attention they expect and demand.

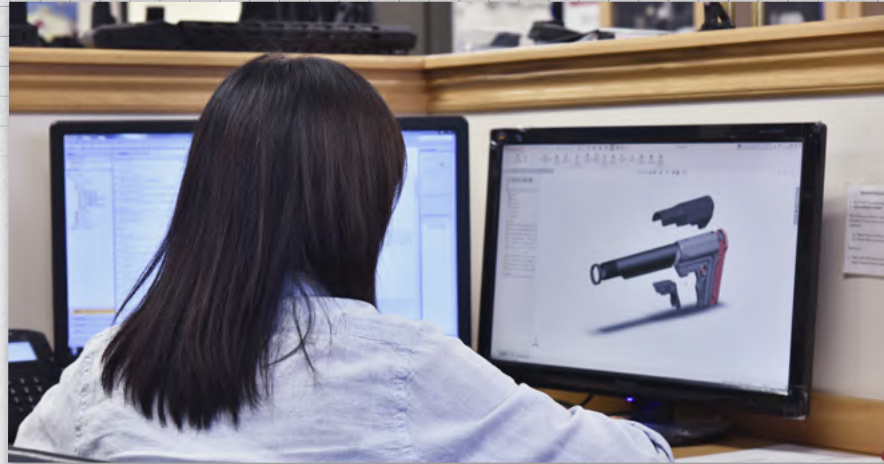

# UTG PRO USA

MANUFACTURING CENTER



Leapers, Inc. started the UTG PRO® line of Made in USA products in 2009. Since then, we have grown from one carbine-length quad rail to offering a wide variety of products across several different product lines. Our manufacturing operation is equipped with industry-leading aerospace grade CNC machines and advanced RoboShot polymer injection molding machines for producing quality polymer products. We dedicated part of our manufacturing space to implement our fully operational in-house Cerakote® finishing facility as well as housing newly acquired Miyano 9-axis CNC Super Turning Centers. The growing popularity of our UTG PRO® products continues to fuel our commitment to provide consumers with USA made products that compete at every level. You can count on Leapers, Inc. to persevere and we value the continuous support from our loyal customers.





## UTG TAIWAN R&D AND MANUFACTURING CENTER



Our company and its primary brands, UTG® and UTG PRO®, in committed efforts to expand the vast product line we are known for announce the grand opening of our UTG Taiwan R&D and Manufacturing Center. With the main objective of advanced technology development and improving international distribution, supply, and logistical efficiency, establishing UTG Taiwan was the next step after having established the UTG PRO® USA Michigan manufacturing center and the UTG Europe division in 2009 and 2012, respectively. UTG Taiwan is now the home to world class Japanese Fanuc and Brother CNC machines, Tsugami 6-axis Swiss machines, Fanuc polymer injection molding, and Fanuc and Yushin robotics for automated manufacturing operations to meet the international demand for quality shooting sports products. In addition, to ensure industrial and mil-spec standards, the facility is equipped with German precision inspection and testing equipment for executing stringent quality control testing, validation, and certification requirements. Products include a unique range of high quality mounts and sights, magazines, OEM components, and a line of integrated optics.



## UTG EUROPE DISTRIBUTION CENTER



“Global Reach with a Local Presence” – this is the focus of UTG Europe to serve the European market. Established in 2012, UTG Europe is located just outside of Frankfurt, Germany. Our customers within the region now directly benefit from its locality and friendly staff to gain quick access to UTG® and UTG PRO® products. As a fully integrated entity, UTG Europe owns and operates from a distribution center with over 21,000 Sq. Ft. of office and warehouse space. This investment was a significant milestone for the Leapers UTG family. It is our answer to the rapidly growing demand for UTG® and UTG PRO® products in the European market, and is our long term commitment support out loyal international customers through improved logistics and caring local support.



## UTG CHINA MANUFACTURING CENTER



The UTG® business philosophy is complete vertical integration. In the past 2 decades, we have consolidated our overseas operations into a wholly owned subsidiary with R&D engineering, manufacturing, and production guided by UTG® quality control and management. To date, in our overseas operations, we have sophisticated technical equipment for light/laser production, specialized dust-free rooms for optics assembly, automated CNC machines for a wide variety of metal parts production and more. When buying UTG® products, you are not buying any sub-contractors' products from unknown sources. You are getting US designed products made from UTG® controlled manufacturing processes, technical assistance, and customer support.



# YOUR ONE STOP SHOP SOLUTION

# EVERYTHING YOU NEED IN ONE PLACE

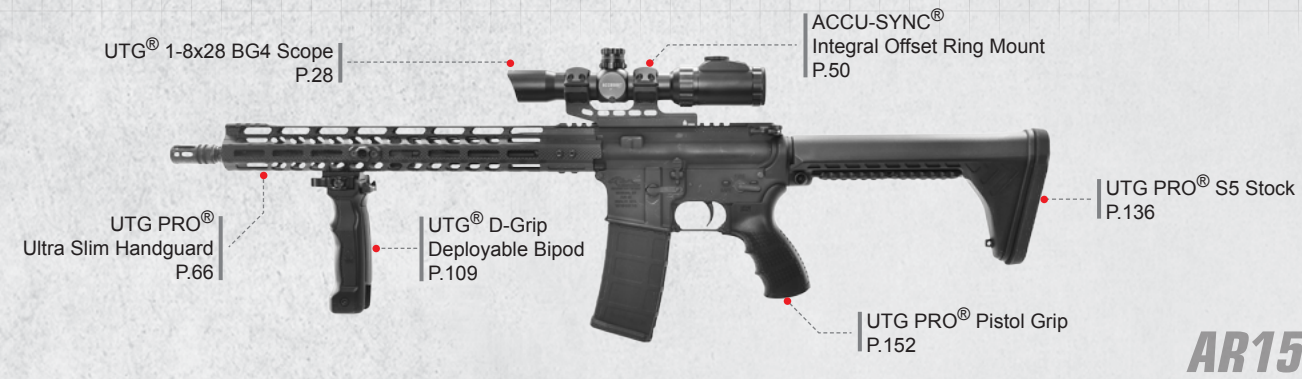

UTG® 1-8x28 BG4 Scope P.28

ACCU-SYNC® Integral Offset Ring Mount P.50

UTG PRO® S5 Stock P.136

UTG PRO® Ultra Slim Handguard P.66

UTG® D-Grip Deployable Bipod P.109

UTG PRO® Pistol Grip P.152

**AR15**



UTG® Bull-Dot Green Laser P.124

UTG PRO® 500 Scope Mount P.95

UTG® 400 Lumen Pistol Light P.120

**MOSSBERG SHOCKWAVE**



UTG® Reflex Micro Dot Sight P.40

UTG® 400 Lumen Pistol Light P.120

UTG PRO® Magazine Base Pad P.130

**GLOCK 19**



UTG® Compact Green Pistol Laser P.124

UTG PRO® Magazine Base Pad P.130

**CZ P10C**



UTG® Flip-up Front Sight P.141

UTG® M-LOK® Handstop P.149

UTG PRO® 2-Tone M-LOK® Handguard P.72

UTG® Reflex Dot Sight P.41

UTG® Flip-up Rear Sight P.141

UTG PRO® Pistol Grip P.152

UTG PRO® Red Anodized Buffer Tube P.138

UTG PRO® S3 Stock P.133

**9MM PCC**

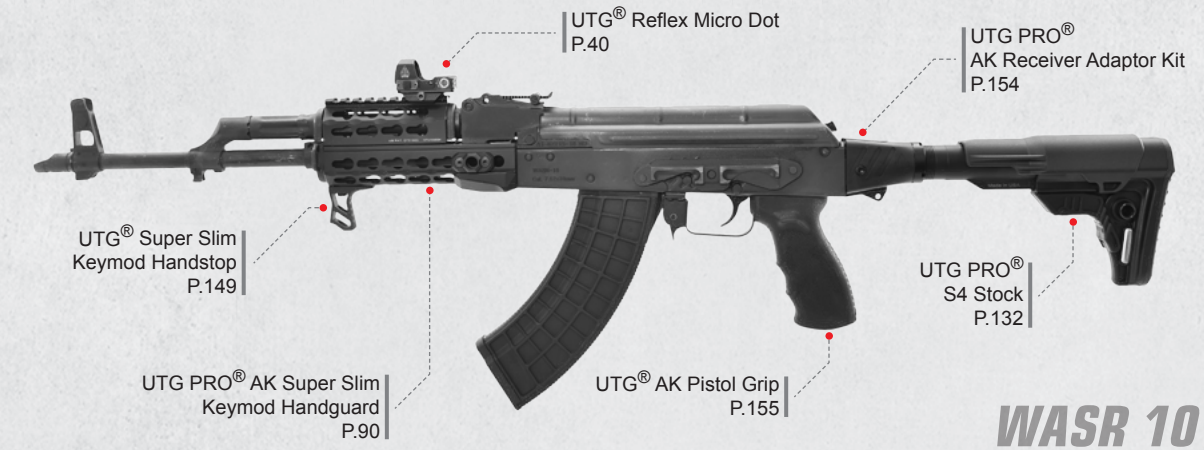

UTG® Reflex Micro Dot P.40

UTG PRO® AK Receiver Adaptor Kit P.154

UTG PRO® S4 Stock P.132

UTG® Super Slim Keymod Handstop P.149

UTG PRO® AK Super Slim Keymod Handguard P.90

UTG® AK Pistol Grip P.155

**WASR 10**

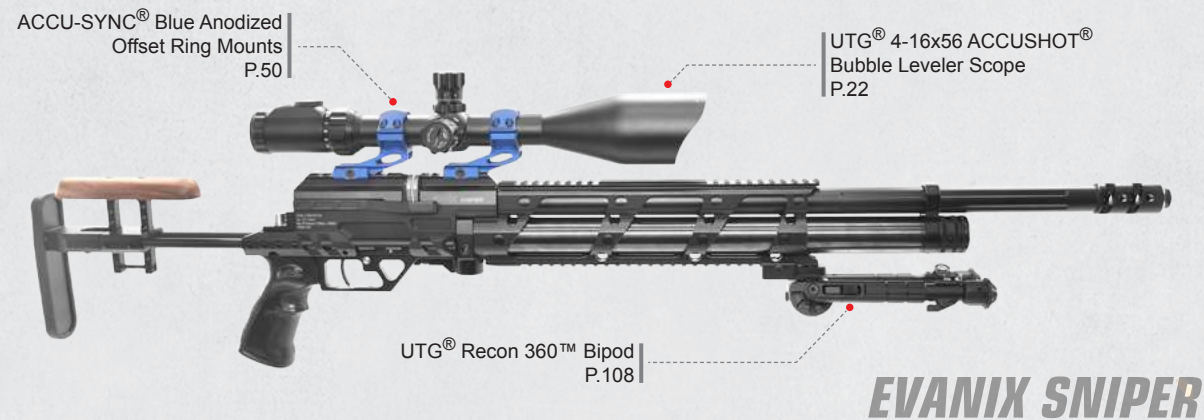

ACCU-SYNC® Blue Anodized Offset Ring Mounts P.50

UTG® Recon 360™ Bipod P.108

UTG® 4-16x56 ACCUSHOT® Bubble Leveler Scope P.22

**EVANIX SNIPER**



UTG® 8-32x56 ACCUSHOT® G4 Scope P.23

ACCU-SYNC® Integral Offset Ring Mount P.50

UTG® Picatinny Panel Covers P.153

UTG PRO® RPR® M-LOK® Handguard P.65

UTG® Recon Flex M-LOK® Bipod P.106

**RUGER PRECISION RIFLE®**



UTG® 400 Lumen Pistol Light P.120

UTG® Keymod Handstop P.149

UTG® Super Slim Fixed Front Sight P.142

UTG® Keymod Panel Covers P.153

UTG® Picatinny Panel Covers P.153

UTG PRO® 10" Super Slim Keymod Handguard P.70

UTG® Reflex Micro Dot P.40

UTG® RDM20 Absolute Co-witness Mount P.84

UTG PRO® Pistol Grip P.152

UTG® Super Slim Rear Sight P.142

UTG PRO® AR Pistol Extension Tube Kit P.139

**AR PISTOL**

# TAILORED TO YOUR BUSINESS

# WHAT YOU NEED, WHERE AND WHEN YOU NEED IT!

INTRODUCTION

MULTI-TIER BUSINESS SOLUTIONS



## E-COMMERCE SOLUTIONS

- ▶ Our artificial intelligence driven software system and automated order fulfillment operations efficiently support e-commerce businesses with large volumes of transactions day in and day out.
- ▶ We work seamlessly with clients to process EDI or other forms of orders.
- ▶ Repeatedly recognized by clients for efficient same day order processing, customizable drop shipping capabilities, and our high quality, professional shipment preparation which will lead to your customer satisfaction.
- ▶ The Best Never Rest Lifetime Warranty ensures your customers get the best support after purchase.



## RETAIL STORE SALES

- ▶ We provide dedicated, personalized, and experienced sales staff to work with you in exploring and selecting products best suited for your locale throughout the year.
- ▶ Equipped with industry-leading logistics software and backed by our world-class order fulfillment operations, we will ensure that your business has what it needs when it needs it.
- ▶ Every detail of our product packaging is designed with store display in mind. Product brands and features are informatively and attractively showcased.
- ▶ Business partnership is welcome to promote the UTG brand and will be supported with any artwork, advertising or multi-media marketing efforts to meet your business goals.

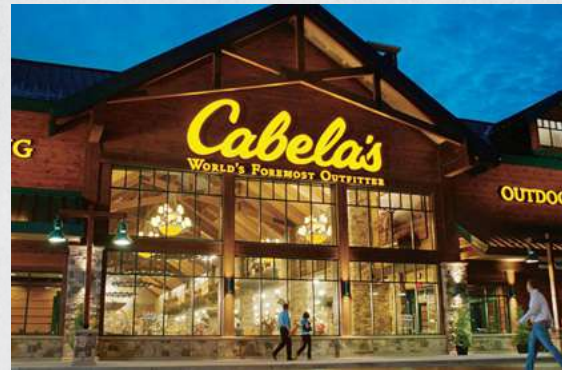

## WHOLESALE DISTRIBUTION

- ▶ We respect the power and reach of wholesale. For distribution partners, we offer pricing structures with generous tier to tier margins, on top of our already competitive pricing.
- ▶ Our pricing is competitive, with shipping and marketing allowances strategized and implemented in advance. It is a trustworthy pricing policy that can easily move products through all channels.
- ▶ We provide complete and total solutions from our unique wide range of shooting and hunting products to support your customer base. Every customer can find something they need from our offering.



## OEM SUPPORT

- ▶ Leapers UTG prides itself as a solution provider. We design, develop, customize, manufacture, and finally sell.
- ▶ We have a solid track record in OEM production and sales.
- ▶ We understand and have what it takes to work with OEM partners. We always prepare for your demands, run production, release and fulfill orders promptly. Your production lines can count on the most reliable support from Leapers UTG.
- ▶ CNC machining, polymer injection molding, in-house Cerakote® finishing, and laser engraving are all our strong suits.
- ▶ Competitive pricing, accommodating MOQ and timely fulfillment are our mottos to meet your goals. We can make your ideas come true with our commitment and collaborated execution.



## MILITARY & LE SUPPORT

- ▶ We support many loyal customers that protect and serve our country in the military, law enforcement and other first responders.
- ▶ We have fulfilled government contracts for accessories and are poised to support many more, especially with our U.S made best quality, competitively priced items.
- ▶ We strive to become a strong pillar of support to those that protect us. No matter if you have a department/unit requirement or a private need, we're always ready to give our best.



INTRODUCTION

MULTI-TIER BUSINESS SOLUTIONS



## INTRODUCTION

Leapers UTG® started in 1992 with a single compact 4X28 scope, which was followed in the next 27 years by a growing selection of innovative optics. Our commitment to offering practical, and innovative optics drives us even further into other shooting sport disciplines to persistently develop optical solutions featuring the most sought after features. The optics we design, refine, and manufacture meet the ultimate goal of satisfying our customer base and their specific application needs. We build all our optics on our proven True Strength® Platform known for its reinforced structure and components capable of withstanding some of the heaviest recoil while upholding a reliable and repeatable zero hold shot to shot. Equipped with advanced optical design software, strike testing simulation, and precision CNC technology, these crucial investments, allow our experienced staff to further achieve breakthrough progress in the quality and performance of our optics. For 2019, Leapers UTG® is proud to debut and introduce our new premium level ACCUSHOT® OP3 series of optics. Featuring our new internally reinforced and finely lockable windage and elevation turrets, locking eyepiece diopter, and high contrast multi-coated lenses for enhanced light transmission and high definition viewfinder clarity.

**LEAPERS, INC.**  
**THE BEST NEVER REST**  
**LIFETIME WARRANTY**

## ABSOLUTE COMMITMENT TO CLARITY, PRECISION, AND QUALITY



State of the Art Quality Control



Total Commitment to Precision



Extreme Environment Testing



Rigorous Quality Control



Dust Free Environment Assembly



Relentless Durability Testing

### NEW AND MUST HAVE PRODUCTS FOR 2019

3-12X44 ACCUSHOT® OP3 Scope



4-16X44 ACCUSHOT® OP3 Scope



3-12X32 Side AD BUGBUSTER® Scope



2.5" Mini Red Single Dot Sight



Reflex Micro Dot



**UTG OPTICS**  
 PRACTICAL INNOVATION. EXCEPTIONAL VALUE.

# INTEGRATED MANUFACTURING

## FROM CONCEPT TO DELIVERY

Under our own disciplined management, Leapers UTG® is one of the few companies in the industry with a full range of vertically integrated operations to support product development, manufacturing, distribution, and service. Customers can always count on our optics to offer the best quality, value, and reliability.



### IN-HOUSE ENGINEERING

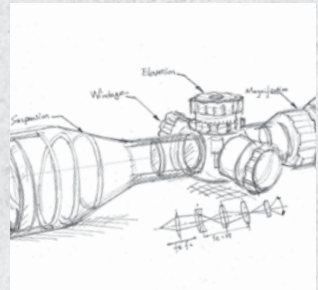

CONCEPT SKETCHING



CAD MODELING

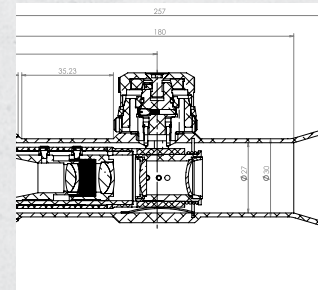

FDM RAPID PROTOTYPING FOR FUNCTION VERIFICATION

### QUALITY CONTROL



STRINGENT LENS CERTIFICATION



CLEAN ROOM ENTRY



FINAL ASSEMBLY QC INSPECTION

### MANUFACTURING



STATE-OF-THE-ART CNC MACHINES



DUST FREE ASSEMBLY



DISCIPLINED ASSEMBLY PROCEDURE

# STRINGENT TESTING

Leapers UTG® spends tremendous effort and investment on product testing. We make sure every scope model gets certified by the Leapers testing team based on our comprehensive testing checklists and procedures. We perform our testing based on actual user input. We gather feedback, carefully analyze their impact and develop appropriate test parameters to ensure optimal performance under all conditions. Our testing includes in-house components and system level validations using state-of-the-art equipment, as well as actual field testing.

## The Elite Product Testing Team is Made of Veterans, Engineers, LE Officers and Firearm/Air Rifle Experts

### BIG GAME HUNTING

**Ryan Brown** is a diehard outdoorsman who started his own production company back in 2009 called TKZ Outdoors - The Kill Zone. His constant pursuit of big game animals has put our products to the test. Ryan comes from a long family history of passionate outdoorsmen. Having hunted the most sought after game in North America all over the state of Michigan, every shot counts when he relies on UTG® to put the food on his table.



### LAW ENFORCEMENT

**John Kapusta** brings with him over 3 decades of firearm industry experience. He has worked with major law enforcement agencies around the country, and trained with elite operators such as the FBI, SEALs, and Springfield SWAT team. As Leapers UTG®'s in-house firearm expert, he personally puts our products through stringent testing on some of the most punishing rifles and shotguns to constantly raise our product's quality and durability.



### COMPETITION

**Ming** is a multi-division Master Class competitor in IDPA, USPSA, and other practical shooting disciplines. His 2018 season accomplishments include winning division champion at the USPSA Michigan Sectional, IDPA Michigan State, Great Lakes Regional, and Indiana State matches, and more. Ming's advanced skill set in practical shooting combined with his industry experience is invaluable and instrumental to our product development across the board.



### HIGH PERFORMANCE AIRGUN

**Tom Gaylord** has been evaluating and writing about air rifles and accessories for over 20 years. His articles appear regularly in all major magazines. Tom has been a mentor, providing our PD Team with very insightful lessons and development suggestions since 1999. He is shown here testing a Leapers 3-9x40 Full Size TS Scope on a Webley Patriot that generates as much as 30 ft-lb of force when shooting even the heaviest of pellets.



# INNOVATIVE TS PLATFORM

## 27 YEARS OF EXPERTISE



### HISTORY, DEVELOPMENT, & TECHNOLOGY

TS, as in True Strength®, is the signature scope construction platform of Leapers UTG® optics. As the name suggests, no matter if it's a full size or compact scope, magnifier or dot sight, we aim to achieve the highest dependability starting at the heart of our scopes' structure. The research and development of this innovative structure was initiated in 2001 and in 2002 the first TS Platform scope was put into mass production. With our continuous testing, verification, and multiple rounds of improvement, we started promoting and selling TS optics on a global scale in 2005. Today, all our optics are built on the tough TS Platform to include a one-piece integral aluminum main tube, meticulously placed reinforcements at key structural points, and nitrogen purging to achieve optimal rainproof, fogproof, and shockproof performance even in the most challenging of scenarios. This superior TS Platform has even been adopted into the lineup of UTG® laser products, giving them precise and secure adjustment.

### SMART SPHERICAL STRUCTURE

The Smart Spherical Structure is one of the most significant characteristics of the TS Platform. The erector tube is constrained via a ball and socket structural relationship, which provides the desirable flexibility to respond to windage and elevation adjustments and the optimal ability to hold zero under heavy recoil.

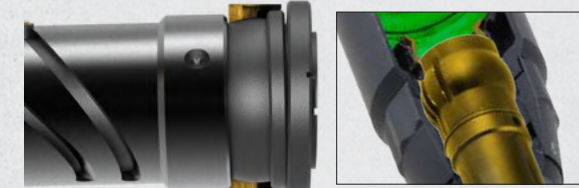

### TRUE STRENGTH® PLATFORM

- Reduces and Absorbs Recoil, Alleviating Potential Loss of Zero.
- Fully Tested on Both Air Rifles and Firearms
- TS Technology Implemented in Every Leapers Scope



# 36 COLOR IE® ILLUMINATION

## ILLUMINATION ENHANCING TECHNOLOGY

### IE® TECHNOLOGY/EZ-TAP® SCOPES

- Low Profile Illumination Control Housing with Reinforced Circuitry Prevents Intermittent Reticle Illumination Even Under the Heaviest of Recoil
- Red & Green Dual-color and 36 Multi-color Modes to Accommodate All Weather & Light Conditions
- 1-click Illumination Memory Returns the User to the Last Color & Brightness Setting Used
- Green Low Power Consumption Technology with Automatic 1 Hour Shut-off

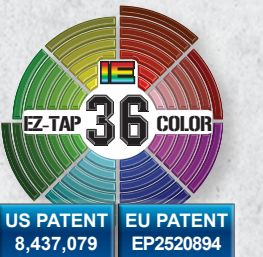
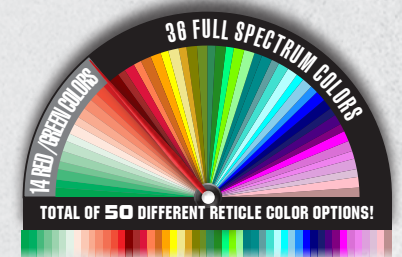

### ADVANCED RECOIL PROOF SYSTEM

- The Most Advanced and User-friendly Windage and Elevation Adjustment System with Innovative Design, Precision Components, and Disciplined Assembly
- UTG®'s Leaf Spring System is Made from a Special Heat Treated Beryllium Bronze Alloy to Maintain Reliable and Consistent Long Term Tension
- ACCUSHOT® Models Equipped with a Rugged Coil Erector Return Spring System For Improved Zero Hold Under Heavy Recoil and Greater Windage/Elevation Adjustment Range





## RETICLE OPTIONS

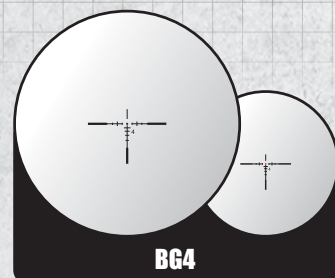

**BG4**

The BG4 Reticle is designed to be fast and intuitive to use and features ballistic drop compensation and rangefinder markings out to 600 yards. The ballistic data is based on common 5.56/.223 loadings in modern sporting rifles. The three thick posts draw the eye to the center for rapid acquisition at close range, while the drop compensation allows for rapid engagement of targets throughout the platform's effective range.

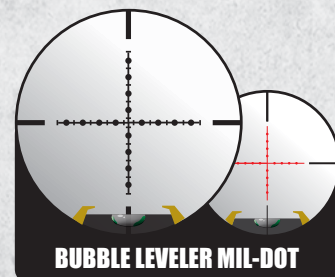

**BUBBLE LEVELER MIL-DOT**

The Bubble Level reticle combines our popular glass-etched Mil-dot with a precision built-in bubble leveling system. The internal bubble leveler is located at the bottom of the reticle. It is a great tool for precision scope installation and crosshair alignment to ensure accurate holdovers at any range.

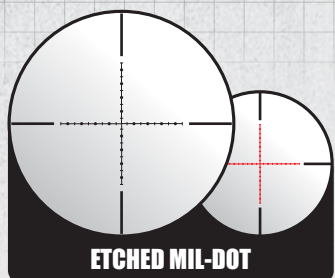

**ETCHED MIL-DOT**

The Mil-dot reticle is the most widely used reticle in our rifle scopes, which provides range estimating capability. The crosshair has dots and dashes spread equally along the X and Y axis. The distance between two adjacent marks subtends to 1 milli-radian. The etched-glass reticle offers our discerning users the sharpest Mil-dot reticle for precise range estimation.

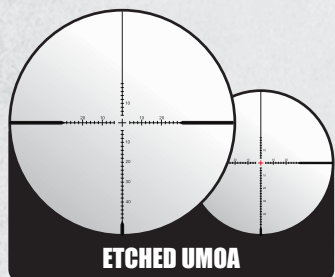

**ETCHED UMOA**

The UMOA reticle features hash marks at minute of angle increments for precise range estimation and bullet drop and wind drift compensation. This reticle is the best choice for long-range precision shooters who want clear adjustments and to rapidly calculate holds. The reticle's center crosshair can be illuminated to assist aiming under different light conditions.

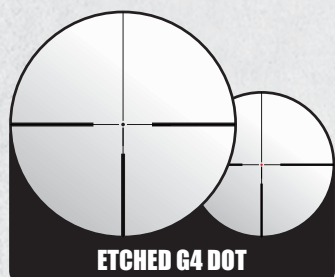

**ETCHED G4 DOT**

The G4 Dot reticle is our take on the classic German #4 design. Thick bars at the 3, 6, and 9 O'clock positions help the eye quickly locate the center of the reticle, yet allowing a less obstructed view. The fine horizontal and vertical lines along with a 0.5 MOA center dot provide the ability for precise aiming whenever needed. The reticle's center dot can be illuminated to assist aiming under different light conditions.

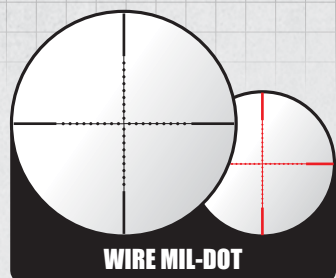

**WIRE MIL-DOT**

The Mil-dot reticle is the most widely used reticle in our rifle scopes, which provides range estimating capability. The crosshair has multiple dots spread equally along the X and Y axis. The distance between two adjacent marks subtends to 1 milli-radian. The traditional wire reticle is robust and holds up against strong recoil and offers a clear aiming reference without compromise.

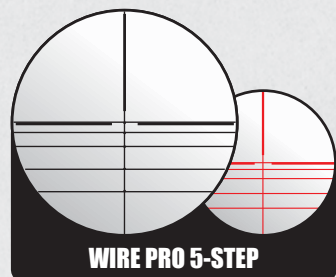

**WIRE PRO 5-STEP**

The Pro 5-step reticle is designed for crossbows. The reticle consists of five horizontal lines and a vertical line, with a thin center crosshair. The horizontal lines are for aiming at 10, 20, 30, 40, and 50 yard distances, calibrated for 300fps crossbows.

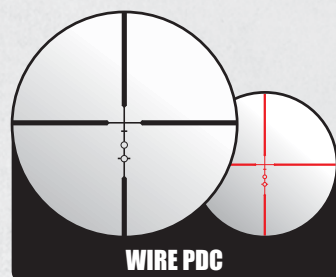

**WIRE PDC**

The Projectile Drop Compensation (PDC) reticle uses different bars and circles arranged at designated heights to aid in range estimation and serve as aiming points set at predetermined distances. This enables easy and rapid target engagement at multiple ranges.

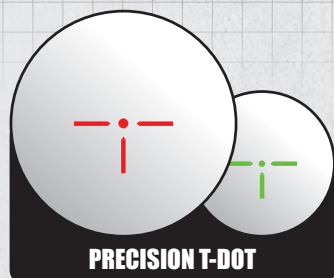

**PRECISION T-DOT**

The T-Dot reticle is ideally used for fast center mass and T-zone aiming applications where getting shots on target quickly is the priority. The reticle consists of a single dot in the center as the aiming point with three floating posts arranged at the 3, 6, and 9 O'clock positions. The posts are very quickly picked up by the eye, framing your target, while the single dot provides precision aiming.

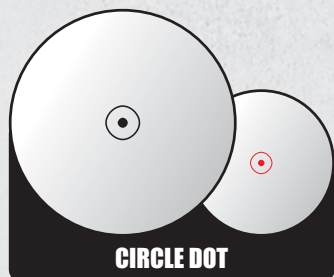

**CIRCLE DOT**

The Circle Dot reticle includes a floating circle and a dot in the center, which is ideal for shotguns, as well as, tactical applications requiring quick target acquisition. This reticle is found etched into the glass of our magnified scopes and projected in the case of our dot sights.

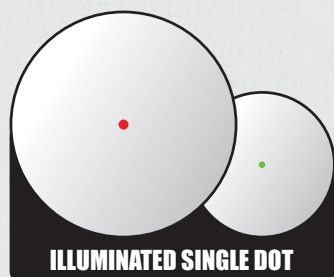

**ILLUMINATED SINGLE DOT**

The Single Dot reticle consists of a single floating dot in the center of the lens with the least visual distraction. This allows for both eyes open aiming, giving the shooter the best situational awareness and cleanest sight picture.

**TS**

### TRUE STRENGTH® (TS) PLATFORM

TS symbolizes the elite quality of Leapers optics. It represents the most robust optical structure designed and made by Leapers UTG®. TS guarantees precise and responsive adjustments, tough recoil resistance, fogproof, rainproof, and shockproof properties. Also refer to P.015.



### IE® 36 COLOR ILLUMINATION

U.S. PAT. 84377079, EU PAT. EP2520894. Most innovative, low profile illumination control with special circuitry and housing design for uninterrupted illumination even under heavy recoil.

**RGB**

### RED/GREEN/BLACK ILLUMINATION

Selectable red/green illumination with standard black non-illuminated reticle.

**RG**

### RED/GREEN ILLUMINATION

Selectable red/green illumination



### BROADBAND MULTI-COATING

With our special broadband multi-coating, light transmission through the lens is enhanced for the complete spectrum of the visible light band. The light transmission rate of the individual lens is over 95% to provide a bright and crisp image during both daylight and low light conditions.



### 30MM 1-PIECE MAIN TUBE

The scope main tube is machined from 1-piece high strength Aircraft Grade aluminum. Compared to other sectional tubes, a 1-piece integral main tube guarantees long term strength and performance integrity. A 30mm tube provides wider windage and elevation adjustment, better light transmission, and larger field of view.



### 1 INCH 1-PIECE MAIN TUBE

The scope main tube is machined from 1-piece high strength aircraft grade aluminum. Compared to other sectional tubes, a 1-piece integral main tube guarantees performance integrity and accuracy. A 1 inch tube along with a well designed optical system can provide a bright and crisp image while being lightweight.



### RINGS & LENS CAPS

Picatinny or .22 Dovetail rings and flip-open lens caps are included.



### FLIP-OPEN LENS CAPS

No more traditional, clumsy lens covers. The flip-open design allows you to open and close the caps quickly and conveniently.



### SUNSHADE INCLUDED

Prevent glare and stray light from directly hitting your objective lens by adding this sunshade. Minimizing the stray light by shading it helps your eyes take advantage of the light that comes from the target.



### TACTEDGE® ANGLED INTEGRAL SUNSHADE

Angled objective tube with integral sunshade shields the objective lens from sunlight or other ambient light for better image contrast and clarity.



### DOUBLE LOCK TURRETS

User friendly turrets for windage/elevation adjustment with a proprietary dual-screw zero locking design to guarantee zero retention.



### TWIST LOCK MOUNTING BASE

Twist Lock for tool free quick installation and removal.



### QD LEVER LOCK

Quick Detach Lever Lock for tool free quick installation and removal.

**3yds**

### ADJUSTABLE OBJECTIVE FROM 3YDS UP

Signature feature of the Bug Buster® series especially loved by airgunners, allowing clear focus of close-range targets.



### PRISMATIC REFRACTION

Sophisticated prism-based design allows for a compact optical system without sacrificing optical quality.



### SWAT PARALLAX CONTROL

Side Wheel Adjustable Turret (SWAT) adjusts the parallax from close in distance to infinity. Designed for single revolution quick target distance adjustment to achieve a parallax-free image. The turret has engraved distance markings and are compatible with UTG® Big Wheels. Refer to P.047.



### FRONT ADJUSTABLE OBJECTIVE

Front Adjustable Objective Ring adjusts parallax from close range to infinity.



### ZERO L/R TURRETS

Zero Locking/Resetting Target Turrets are designed with a rotational locking ring. Unlocking the ring allows for precise windage and elevation adjustment. Loosening the turret hex screw will allow for zero resetting.



### WINDAGE/ELEVATION LOCKABLE

Windage/Elevation adjustment can be locked for effective zero retention.



### UNLIMITED EYE RELIEF

If you see the dot, you can hit your target regardless of eye relief distance.



### EXTENDED EYE RELIEF

Eye relief tailored towards firearms which require optics replaced farther forward on the receiver.



### IPX7 WATERPROOF

Able to withstand immersion in water up to 1 meter for up to 30 minutes.



### PATENTED

Product or included accessories are patented.



	ACCUSHOT® OP3 SERIES	ACCUSHOT® PREMIUM SERIES	ACCUSHOT® PRECISION SERIES	ACCUSHOT® SCOUTING SERIES	T8 TACTICAL SERIES	T4 TACTICAL SERIES	ACCUSHOT® TACTICAL SERIES	BUGBUSTER® SERIES	TRUE HUNTER™ IE SERIES	TRUE HUNTER™ CLASSIC SERIES	REFLEX SIGHTS & MAGNIFIER	UTG® DOT SIGHTS	AIR RIFLE SCOPE SERIES	CROSSBOW & HANDGUN SCOPE SERIES
<b>PAGE RANGE</b>	<b>P.020-021</b> 3-12x44 MOA...OP3-GM3124UMOA 4-16x44 MOA...OP3-GM4164UMOA 3-12x44 Mil-dot...OP3-M3124AOIEW 4-16x44 Mil-dot...OP3-M4164AOIEW	<b>P.022-023</b> 4-16x56...SCP3-UG4165AOIEWB (Bubble Leveler) 8-32x56...SCP3-UG832AOIEW (Mil-dot) 6-24x56...SCP3-UG6245AOIEW (Mil-dot) 4-16x56...SCP3-UG4165AOIEW (Mil-dot) 8-32x56 G4...SCP3-UG832G4 (G4) 4-16x56 G4...SCP3-UG4165G4 (G4)	<b>P.024-025</b> 4-16x44...SCP3-U416AOIEW (Mil-dot) 3-12x44...SCP3-UG312AOIEW (Mil-dot) 3-12x44...SCP3-U312AOIEW (Mil-dot)	<b>P.026-027</b> 1-4x28 Mil-dot...SCP3-14UEMDQ 1-4x28 Circle Dot...SCP3-14UEODQ 2-7x44 Mil-dot...SCP3-274LAOIEW 1-8x28...SCP3-18IEMDQ (Mil-dot for CQB/MRC) 1-8x28...SCP3-18IECDQ (Circle Dot for CQB/MRC) 2-16x44...SCP3-216AOIEW (Mil-dot) 2-16x44...SCP3-216UMOA (MOA) 2-16x44...SCP3-216G4 (G4)	<b>P.028-029</b> 1-8x28...SCP3-18IEBG4 (G4) 1-8x28...SCP3-18IEMDQ (Mil-dot for CQB/MRC) 1-8x28...SCP3-18IECDQ (Circle Dot for CQB/MRC) 2-16x44...SCP3-216AOIEW (Mil-dot) 2-16x44...SCP3-216UMOA (MOA) 2-16x44...SCP3-216G4 (G4)	<b>P.030-031</b> 4x32 Mil-dot...SCP-T4IEMDQ 4x32 Circle-dot...SCP-T4IEODQ 4x32 T-dot...SCP-T4IETDQ	<b>P.032-033</b> 1-4.5x28 Circle Dot...SCP3-145IECDQ 1-4.5x28 Mil-dot...SCP3-145IEMDQ 1.5-6x44 Wire...SCP3-U156IEW 1.5-6x44 Glass...SCP3-UG156IEW 3-12x44 Wire...SCP3-UM312AOIEW 3-12x44 Glass...SCP3-UGM312AOIEW 4-16x44 Wire...SCP3-UM416AOIEW 4-16x44 Glass...SCP3-UGM416AOIEW 10x44 Glass...SCP3-UGM104AOIEW	<b>P.034-035</b> 3-12x32...SCP-M312AOWQ (Mil-dot with Picatinny Rings) 3-12x32...SCP-M312AOD (Mil-dot with Dovetail Rings) 3-9x32...SCP-M392AOD (Mil-dot with Dovetail Rings) 3-9x32...SCP-M392AOLWQ (Mil-dot with Picatinny Rings) 4x32...SCP-M432IEWQ (Mil-dot with Picatinny Rings)	<b>P.036-037</b> 3-9x40 Mil-dot...SCP-U394AOIEW 3-9x40 Mil-dot...SCP-U394AOIED 3-9x50 Mil-dot...SCP-U395AOIEW 3-12x40 Mil-dot...SCP-U312AOIEW 4-16x40 Mil-dot...SCP-U4164AOIEW 4-16x50 Mil-dot...SCP-U4165AOIEW 6-24x50 Mil-dot...SCP-U6245AOIEW	<b>P.038-039</b> 3-9x32 AO TF2+...SCP-U392AODT2 3-9x32 Air Rifle...SCP-U392RFD 3-9x40 TF2+...SCP-U394FDT2 3-9x40 TF2+...SCP-U394FWT2 4x32 AO...SCP-U432AOWT2 4x32 Full Size...SCP-U432FD 4x32 Full Size...SCP-U432FW 4x32 Mini...SCP-U432M1	<b>P.040-041</b> 3.9" Circle Dot...SCP-RDM39CDQ 3.9" Single Dot...SCP-RDM39SDQ 2" Red Dot...SCP-RDM20R 2" Green Dot...SCP-RDM20G 3x Magnifier...SCP-MF3WEQS	<b>P.042-043</b> 2.5" Tactical Single Dot...OP-DS2521R 6" Tactical Single Dot...SCP-TDSDQ 6" Tactical T-dot...SCP-TDSTDQ 6.4" Target Dot...SCP-DS3068W 6.4" Tactical T-dot...SCP-DS3068TDQ 4.2" Target Dot...SCP-DS3840W 4.2" Tactical T-dot...SCP-DS3840TDQ 2.6" Target Dot...SCP-DS3026W 3.9" Target Dot...SCP-DS3039W 3.8" Target Dot...SCP-RD40RGW-A 3.8" Circle Dot...SCP-RG40CDQ 3.8" Target Dot...SCP-RG40SDQ	<b>P.044-045</b> 2-16x44...SCP3-216UMOA 3-9x32...SCP-M392AODQ 3-9x32 AO TF2+...SCP-U392AODT2 3-9x40...SCP-U394AOIED 3-12x32...SCP-M312AODQ 3-12x44...SCP3-UG312AOIEW 4x32 Full Size...SCP-U432FD 4-16x40...SCP-U4164AOIEN 4-16x56...SCP3-UG4165AOIEWB 4-16x56...SCP3-UG4165AOIEW 6-24x56...SCP3-UG6245AOIEW	<b>P.046</b> 4x32 Crossbow...SCP-M4CR5WQ 2-7x32 Handgun...SCP-27PRGW
<b>HIGHLIGHTS</b>	A new line of premium optics featuring improvements in resolution through optimized internal light transmission pathway, crisp and tactile turret movement with exacting increments and consistent per click adjustment, and updated IPX7 waterproof rating. Additional features include a set-once locking eyepiece diopter and wider surface turret heads for ease of making adjustments with or without gloves. Available in either 3-12x or 4-16x with mil-dot or UMOA reticle.	High magnification power up to 32X, 30mm 1-piece main tube, etched glass reticle, IE® full color illumination and advanced broadband multi-coated lenses providing the best image quality, wide field of view, precise zeroing and reliable zero holding.	Optimal mid-range magnification power up to 16X, 30mm 1-piece main tube, etched glass or wire reticle, IE® full color illumination and advanced broadband multi-coated lenses providing the best image quality, wide field of view, precise zeroing and reliable zero holding.	Incredible extended eye relief, 30mm main tube, IE® full color illuminated etched glass reticle, wide field of view and multi-coated lenses. Rugged structure, optimal eye relief and amazing wide angle field of view ensuring a great shooting experience for any handguns/scout applications.	Lightweight, close to medium range optics ideal for MSRs and featuring several reticle models to choose from including our new BG4 Ballistic drop compensating and range finding etched-glass reticle calibrated for the .223/5.56 cartridges. An optimized eye relief and field of view, for its size makes, the T8 Tactical series a formidable option for AR platform rifles and more.	Versatile 4X32 fixed power magnification in a compact package made possible through prismatic refraction technology, ideally suited as a general purpose magnified optic for the AR platform and other MSRs.	A series of low and medium power magnification optics ideal for a variety of different long gun applications and featuring compact main tubes and both wire and etched-glass reticle models.	Compact and lightweight mil-dot wire reticle scopes with 3 yards to infinity parallax adjustment range for majority of models. Illuminated and non-illuminated models available along with models reaching as high as 12X magnification.	Featuring 1-inch full-size main tube, front adjustable objective from 5 yards to infinity, convenient zero locking /resetting W/E turrets, IE® full color illuminated Mil-dot reticle, variable power, broadband multi-lens coating, and adjustable eyepiece. All fully tested and certified by the strictest industry standards.	Featuring our TF2+ windage and elevation turrets, simply pull up to make your adjustments and push down to lock them in. A high value, budget-minded, and straight-forward series of mil-dot wire reticle optics with fixed power and variable power magnification models available.	Reflex micro dots available with either red or green 4 MOA single dot reticles. Equipped with an adaptive base, these versatile micro dots are an extremely low profile and lightweight optic suitable for pistols, shotguns, pistol caliber carbines, and MSRs. Compatible with most Optics-ready pistols in the market. Absolute co-witness, 45 degree, and rear sight dovetail mounts available through UTG®.	Series of 1X magnification dot sights available in single dot, circle dot, or T-dot reticles. Dual red and green illumination standard on most models. A plethora of different mounting solutions from QD, fixed, to offset and height adjustable.	Excellent choice for air rifle applications.	Based off the TS Platform, our amazingly unique crossbow/handgun optics are specifically equipped with a parallax preset ideally for the effective range of most crossbows and handguns. They are featured with either reticle for crossbow or PRD 4-step Projectile Drop Compensation (PDC) reticle for quick aiming at different yardage.
<b>APPLICATIONS</b>	Bolt Action Rifles, DMRs, MSRs, SPRs	Extended Long Range Precision Bolt Action and Semi-automatic Rifles	Bolt Action Rifles, DMRs, MSRs, SPRs	Scout Style and Lever Action Rifles	AR15& AR308 platform, Bullpups, MSRs, DMRs, SPRs	AR platform and other MSRs	Bolt Action Rifles, DMRs, MSRs, SPRs	AR Platform and Other MSRs, Bullpups, .22 Rifles, Bolt Action Rifles	Extended Long Range Precision Bolt Action and Semi-automatic Rifles	Centerfire and Rimfire Bolt Action Rifles, Air Rifles	Pistols, Shotguns, MSRs, Rimfire Rifles and Pistols, as Backup to a Primary Magnified Optic, Optics-ready Pistols, Pistol Caliber Carbines, AR Pistols	MSRs, Pistol Caliber Carbines, Shotguns, Rimfire Rifles and Pistols	Air Rifles	Crossbows & Pistols
<b>SUGGESTED USES:</b>	Precision Target Shooting, Bench Rest Shooting, Medium to Long Range Precision Shooting, Hunting, Recreational	Precision Target Shooting, Bench Rest Shooting, Long Range Precision Shooting, Recreational	Precision Target Shooting, Bench Rest Shooting, Medium to Long Range Precision Shooting, Hunting, Recreational	Close to Medium Range Precision Shooting, Hunting, Ranch Rifle, Backpacking Rifle, Recreational	Multi-range Precision Shooting, 3-Gun Competition, Home and Personal Defense, Hunting, Recreational, Defense and Law Enforcement Agencies	Multi-range Precision Shooting, Home and Personal Defense, Recreational, Defense and Law Enforcement Agencies	Multi-range Precision Shooting, Home and Personal Defense, Hunting, Recreational, Defense and Law Enforcement Agencies	General Purpose, Home and Personal Defense, Hunting, Recreational, Plinking	Precision Target Shooting, Bench Rest Shooting, Long Range Precision Shooting, Recreational	Close to Medium Range Precision Shooting, Hunting, Plinking, Budget Builds, Youth Builds, Recreational	Close to Medium Range Shooting, Steel Shooting, Plinking, Carry, Shooting Sport and Competition, Custom Builds, Recreational	Close to Medium Range Shooting, Steel Shooting, Plinking, Shooting Sport and Competition, Custom Builds, Recreational	Air Rifles, etc.	Hunting, Recreational
<b>PARALLAX ADJUSTMENT</b>	Side Wheel 10Yds to Infinity	Side Wheel 10Yds to Infinity	Side Wheel 10Yds to Infinity	Preset at 100Yds / Side Wheel 10Yds to Infinity	Side Wheel 10Yds to Infinity/Preset at 100 or 35Yds	Preset at 100Yds	Side Wheel 10Yds to Infinity Preset at 100Yds	Front/Side AO 3Yds to Infinity	Front AO 5Yds or 10Yds to Infinity	Front AO 5Yds to Infinity Preset at 35Yds or 100Yds	N/A	N/A	Please Refer to Related Subcategories	Preset at 50Yds or 35Yds
<b>ILLUMINATION</b>	IE® 36-color with EZ-TAP® Control	IE® 36-color with EZ-TAP® Control	IE® 36-color with EZ-TAP® Control	IE® 36-color with EZ-TAP® Control	IE® 36-color with EZ-TAP® Control	IE® 36-color with EZ-TAP® Control	IE® 36-color with EZ-TAP® Control	IE® 36-color with EZ-TAP® Control/RGB Side Wheel/No Illumination	IE® 36-color with EZ-TAP® Control	No Illumination	Red/Green for Reflex Sight Only	Red/Green	Please Refer to Related Subcategories	RGB Side Wheel
<b>INCLUDED SCOPE RINGS</b>	MS Twist Lock Rings Included	MS Twist Lock Rings Included	MS Twist Lock Rings Included	MS Lever Lock Rings Included	MS Lever Lock Rings Included	Integral Bidirectional Mounting Deck	Includes MS Lever Lock QD Rings or Twist Lock Rings	MS Lever Lock QD Rings Included	MS Twist Lock Rings Included for Selected Models (SCP-U4164AOIEW - RGWM-25H4)	Picatinny Rings or Air Rifle Rings Included	Picatinny Base Included	QD Lever Lock/Ring Base or Picatinny Base Included	Please Refer to Related Subcategories	MS/ACCUSHOT® Lever Lock /Twist Lock QD Rings Included



# ACCUSHOT® OP3 SERIES

FOLLOW THROUGH AT ALL DISTANCES

Please refer to P.017 for details.

- TS** TRUE STRENGTH® PLATFORM
- IE 36 COLOR ILLUMINATION
- BROADBAND MULTI-COATING
- 30MM 1-PIECE MAIN TUBE
- RINGS & LENS CAPS
- ZERO L/R TURRETS
- SUNSHADE INCLUDED
- SWAT PARALLAX CONTROL
- IPX7 WATERPROOF

**PARTS INCLUDED**

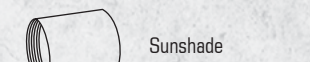
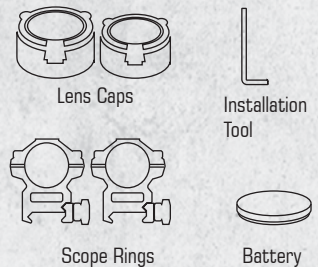

**COMPATIBLE ITEMS**



Reinforced Zero Locking/  
Resetting Target Turrets

Crisp, Tactile Feedback

Improved Circuitry  
Prevents Intermittent  
Illumination and  
Features Lower  
Power Consumption

Locking  
Eyepiece  
Diopter

Wider Turret Face  
for Use with Gloves

Threaded for Included  
Sunshade

High Contrast Multi-coated  
Lenses for Optimal Light  
Transmission and High  
Definition Viewfinder Clarity

**NEW**

**ETCHED GLASS RETICLE**

10 YDS TO INFINITY  
**3-12X44**

30MM OP3-GM3124UMOA  
ACCUSHOT® OP3 30mm 3-12x44  
Compact Etched UMOA Reticle Scope

Side Wheel Adjustable Turret (SWAT)  
Adjusts Parallax from 10 Yards to Infinity



Improved Resolution through Optimization of Internal Light Transmission Pathway and Lens Quality



Crisp and Tactile Turret Movement with Consistent Per Click Adjustment



IPX7 Waterproof Rated



Set Once Locking Eye Piece Diopter



**NEW**

**ETCHED GLASS RETICLE**

10 YDS TO INFINITY  
**4-16X44**

30MM OP3-GM4164UMOA  
ACCUSHOT® OP3 30mm 4-16x44  
Compact UMOA Reticle Scope

**NEW**

**WIRE RETICLE**

10 YDS TO INFINITY  
**3-12X44**

30MM OP3-M3124AOIEW  
ACCUSHOT® OP3 30mm 3-12x44  
Compact Mil-dot Reticle Scope

**NEW**

**WIRE RETICLE**

10 YDS TO INFINITY  
**4-16X44**

30MM OP3-M4164AOIEW  
ACCUSHOT® OP 30mm 4-16x44  
Compact Mil-dot Reticle Scope

Model #	OP3-GM3124UMOA	OP3-GM4164UMOA	OP3-M3124AOIEW	OP3-M4164AOIEW
Magnification	3x-12x	4x-16x	3x-12x	4x-16x
Tube Diameter	30mm	30mm	30mm	30mm
Objective Diameter	44mm	44mm	44mm	44mm
Field of View @100 Yards	32.0' - 10.0'	26.2' - 8.0'	32.0' - 10.0'	26.2' - 8.0'
Eye Relief	3.70" - 3.23"	3.70" - 3.23"	3.70" - 3.23"	3.70" - 3.23"
Exit Pupil	13.0 - 3.9mm	11 - 3mm	13.0 - 3.9mm	11 - 3mm
Click Value @100 Yards	1/4"	1/4"	1/4"	1/4"
Length	10.1"	10.7"	10.1"	10.7"
Weight	21oz	21.5oz	21oz	21.5oz
Parallax Setting	10Yds to Infinity	10Yds to Infinity	10Yds to Infinity	10Yds to Infinity
Rings	RG2W3154 (P055)	RG2W3154 (P055)	RG2W3154 (P055)	RG2W3154 (P055)
Batteries	CR2032 3V	CR2032 3V	CR2032 3V	CR2032 3V



# ACCUSHOT® PREMIUM SERIES

## BIG GAME HUNTING & LONG RANGE COMPETITION

Please refer to P.017 for details.

- TS** TRUE STRENGTH® PLATFORM
- IE 36 COLOR ILLUMINATION
- BROADBAND MULTI-COATING
- 30MM 1-PIECE MAIN TUBE
- RINGS & LENS CAPS
- ZERO L/R TURRETS
- ANGLED INTEGRAL SUNSHADE
- SWAT PARALLAX CONTROL

### PARTS INCLUDED

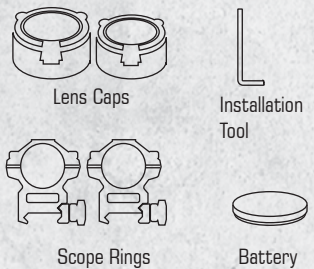

### COMPATIBLE ITEMS

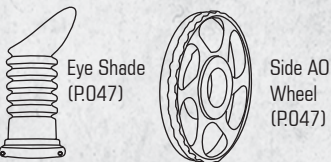

Built with a 30mm tube and broadband multi-coated lenses, these scopes feature high power magnification, mil-dot reticle, side parallax adjustment, zero locking/resetting turrets, and the TactEdge® angled integral sunshade. Our latest premium scope features a sophisticated bubble leveler that is directly viewable through the view finder for an even higher level of premium precision.



**ETCHED GLASS RETICLE**  
 10 YDS TO INFINITY  
**4-16X56**  
 30MM SCP3-UG4165A0IEWB  
 ACCUSHOT® 30mm 4-16x56 Bubble Leveler Etched Mil-dot Reticle Scope

**ETCHED GLASS RETICLE**  
 10 YDS TO INFINITY  
**4-16X56**  
 30MM SCP3-UG4165A0IEW  
 ACCUSHOT® 30mm 4-16x56 Mil-dot Reticle Scope

**ETCHED GLASS RETICLE**  
 10 YDS TO INFINITY  
**4-16X56**  
 30MM SCP3-UG4165G4  
 ACCUSHOT® 30mm 4-16x56 G4 Reticle Scope

**ETCHED GLASS RETICLE**  
 10 YDS TO INFINITY  
**6-24X56**  
 30MM SCP3-UG6245A0IEW  
 ACCUSHOT® 30mm 6-24x56 Mil-dot Reticle Scope

**ETCHED GLASS RETICLE**  
 10 YDS TO INFINITY  
**8-32X56**  
 30MM SCP3-UG832A0IEW  
 ACCUSHOT® 30mm 8-32x56 Mil-dot Reticle Scope

**ETCHED GLASS RETICLE**  
 10 YDS TO INFINITY  
**8-32X56**  
 30MM SCP3-UG832G4  
 ACCUSHOT® 30mm 8-32x56 G4 Reticle Scope



Model #	SCP3-UG4165A0IEWB	SCP3-UG832A0IEW	SCP3-UG6245A0IEW	SCP3-UG4165A0IEW	SCP3-UG832G4	SCP3-UG4165G4
Magnification	4x-16x	8x-32x	6x-24x	4x-16x	8x-32x	4x-16x
Tube Diameter	30mm	30mm	30mm	30mm	30mm	30mm
Objective Diameter	56mm	56mm	56mm	56mm	56mm	56mm
Field of View @100 Yards	24.4' - 6.8'	13.1' - 3.7'	14.7' - 4.7'	24.4' - 6.8'	13.1' - 3.7'	24.4' - 6.8'
Eye Relief	3.2" - 3.0"	3.4" - 3.3"	3.4" - 3.3"	3.2" - 3.0"	3.4" - 3.3"	3.2" - 3.0"
Exit Pupil	14 - 3.5mm	7.0 - 1.8mm	9.3 - 2.3mm	14 - 3.5mm	7.0 - 1.8mm	14 - 3.5mm
Click Value @100 Yards	1/8"	1/8"	1/8"	1/8"	1/8"	1/8"
Length	16.0"	17.52"	17.52"	16.0"	17.52"	16.0"
Weight	31.7oz	32.2oz	32.2oz	27.4oz	32.2oz	27.4oz
Parallax Setting	10Yds - Infinity	10Yds - Infinity	10Yds - Infinity	10Yds - Infinity	10Yds - Infinity	10Yds - Infinity
Rings	RG2W3224 (P.055)	RG2W3224 (P.055)	RG2W3224 (P.055)	RG2W3224 (P.055)	RG2W3224 (P.055)	RG2W3224 (P.055)
Batteries	CR2032 3V	CR2032 3V	CR2032 3V	CR2032 3V	CR2032 3V	CR2032 3V

- Adjustment Markers Help Shooters Track Turret Rotations and Provide Quick References for Elevation Adjustment
- Bubble Leveler within View Finder Aids in Reducing Long Range Errors Caused by Canting



# ACCUSHOT® PRECISION SERIES

PRECISION TARGET SHOOTING AND HUNTING

Please refer to **P.017** for details.

- TS** TRUE STRENGTH® PLATFORM
- IE 36 COLOR ILLUMINATION
- BROADBAND MULTI-COATING
- 30MM 1-PIECE MAIN TUBE
- RINGS & LENS CAPS
- ZERO L/R TURRETS
- ANGLED INTEGRAL SUNSHADE
- SWAT PARALLAX CONTROL

**PARTS INCLUDED**

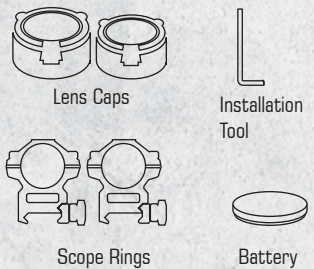

**COMPATIBLE ITEMS**

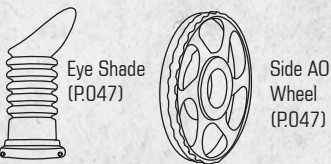

We expanded the full-size IE® scopes' configuration to include more models to form the ACCUSHOT® Precision Series in practical mid-range power.



**IE® WIRE RETICLE**

10 YDS TO INFINITY  
**4-16X44**

30MM SCP3-U416A0IEW  
ACCUSHOT® 30mm 4-16x44 Full-size Mil-dot Reticle Scope

Side Wheel Adjustable Turret (SWAT) Adjusts The Parallax from 10 Yards to Infinity



Smart Spherical Structure Design for Optimal Zero Hold Under Recoil

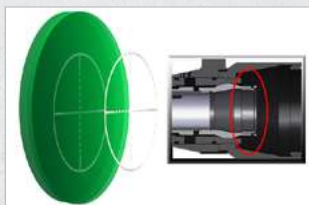

Some Models Available with Etched Glass Reticle



Side Wheel Adjustable Turret Compatible with Add-on Big Wheel (Sold Separately)



**ETCHED GLASS RETICLE**

10 YDS TO INFINITY  
**3-12X44**

30MM SCP3-UG312A0IEW  
ACCUSHOT® 30mm 3-12x44 Full-size Mil-dot Reticle Scope

**IE® WIRE RETICLE**

10 YDS TO INFINITY  
**3-12X44**

30MM SCP3-U312A0IEW  
ACCUSHOT® 30mm 3-12x44 Full-size Mil-dot Reticle Scope

Model #	SCP3-U416A0IEW	SCP3-U312A0IEW	SCP3-UG312A0IEW
Magnification	4x-16x	3x-12x	3x-12x
Tube Diameter	30mm	30mm	30mm
Objective Diameter	44mm	44mm	44mm
Field of View @100 Yards	24.4' - 6.8'	34.0' - 8.5'	34.0' - 8.5'
Eye Relief	3.2" - 3.0"	3.3" - 3"	3.3" - 3"
Exit Pupil	10.2 - 2.8mm	13.1 - 3.7mm	13.1 - 3.7mm
Click Value @100 Yards	1/4"	1/4"	1/4"
Length	15.4"	14.0"	14.0"
Weight	23.4oz	22.7oz	22.7oz
Parallax Setting	10Yds - Infinity	10Yds - Infinity	10Yds - Infinity
Rings	RG2W3154 (P.055)	RG2W3154 (P.055)	RG2W3154 (P.055)
Batteries	CR2032 3V	CR2032 3V	CR2032 3V



# ACCUSHOT® SCOUTING SERIES

## EXTENDED LONG EYE RELIEF OPTICS

Please refer to P.017 for details.

- TS** TRUE STRENGTH® PLATFORM
- IE 36 COLOR ILLUMINATION
- BROADBAND MULTI-COATING
- 30MM 1-PIECE MAIN TUBE
- RINGS & LENS CAPS
- ZERO L/R TURRETS
- ANGLED INTEGRAL SUNSHADE
- EXTENDED LONG EYE RELIEF

### PARTS INCLUDED

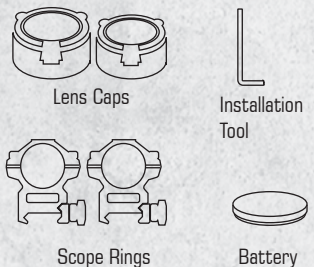

### COMPATIBLE ITEMS

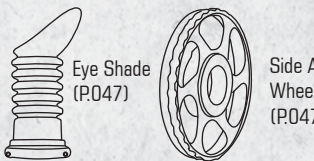

All the same features you've come to expect in our Precision Series, such as 36 color IE® and Zero Locking/Resetting Turrets are built into the Scout Series. You also get the extended eye relief which enables shooters to rapidly engage multiple targets while keeping both eyes open.



**ETCHED GLASS RETICLE**

10 YDS TO INFINITY  
**2-7X44**

30MM SCP3-274LA0IEW  
ACCUSHOT® 30mm 2-7x44 Long Eye Relief Mil-dot Reticle Scope

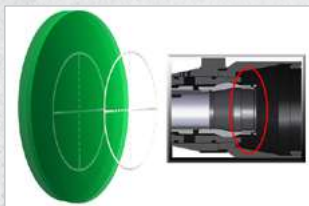

Reliable Etched Glass Reticle



Side Wheel Adjustable Turret Models Compatible with Add-on Big Wheel (Sold Separately)



Robust Coil Erector Return Spring System Providing Lasting Tension For Zero Hold



**ETCHED GLASS RETICLE**

PARALLAX PRESET AT 100 YDS  
**1-4X28**

30MM SCP3-14LIECDQ  
ACCUSHOT® 30mm 1-4x28 Long Eye Relief Circle Dot Reticle Scope

**ETCHED GLASS RETICLE**

PARALLAX PRESET AT 100 YDS  
**1-4X28**

30MM SCP3-14LIEMDQ  
ACCUSHOT® 30mm 1-4x28 Long Eye Relief Mil-dot Reticle Scope

Model #	SCP3-274LA0IEW	SCP3-14LIEMDQ	SCP3-14LIECDQ
Magnification	2x-7x	1x-4x	1x-4x
Tube Diameter	30mm	30mm	30mm
Objective Diameter	44mm	28mm	28mm
Field of View @100 Yards	32° - 10'	78.4' - 21'	78.4' - 21'
Eye Relief	11 - 9.5"	14" - 8"	14" - 8"
Exit Pupil	22 - 6.3mm	28 - 7mm	28 - 7mm
Click Value @100 Yards	1/4"	1/2"	1/2"
Length	11.5"	10.6"	10.6"
Weight	25.4oz	19.8oz	19.8oz
Parallax Setting	10Yds - Infinity	100Yds	100Yds
Rings	RQ2W3154 (P.055)	RQ2W3154 (P.055)	RQ2W3154 (P.055)
Batteries	CR2032 3V	CR2032 3V	CR2032 3V



# ACCUSHOT® T8 TACTICAL SERIES

VERSATILE OPTICS FOR MULTI-APPLICATIONS

Please refer to P.017 for details.

- TS** TRUE STRENGTH® PLATFORM
- IE 36 COLOR ILLUMINATION
- BROADBAND MULTI-COATING
- 30MM 1-PIECE MAIN TUBE
- RINGS & LENS CAPS
- ZERO L/R TURRETS
- PARTS INCLUDED

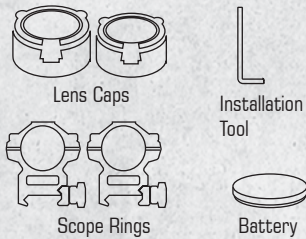

Innovatively designed and ruggedly built CQB/MRC (Multi-Range Combat & Competition) scopes with a generous eye relief and amazing optical clarity for avid hunters and 3-gun competitors.

## 8X ZOOM IN A COMPACT PACKAGE



PARALLAX PRESET AT 100 YDS

### 1-8X28

30MM SCP3-18IEBG4

ACCUSHOT® 30mm 1-8x28 MRC (Multi-range Combat / Competition) BDC BG4 Reticle Scope



PARALLAX PRESET AT 100 YDS

### 1-8X28

30MM SCP3-18IEMDQ

ACCUSHOT® 30mm 1-8x28 MRC (Multi-range Combat / Competition) Mil-dot Reticle Scope



PARALLAX PRESET AT 100 YDS

### 1-8X28

30MM SCP3-18IECDQ

ACCUSHOT® 30mm 1-8x28 MRC (Multi-range Combat / Competition) Circle Dot Reticle Scope



10 YDS TO INFINITY

### 2-16X44

30MM SCP3-216UMOA

ACCUSHOT® 30mm 2-16x44 MRC (Multi-range Combat / Competition) UMOA Reticle Scope



10 YDS TO INFINITY

### 2-16X44

30MM SCP3-216AIEW

ACCUSHOT® 30mm 2-16x44 MRC (Multi-range Combat / Competition) Mil-dot Reticle Scope



10 YDS TO INFINITY

### 2-16X44

30MM SCP3-216G4

ACCUSHOT® 30mm 2-16x44 MRC (Multi-range Combat / Competition) G4 Reticle Scope

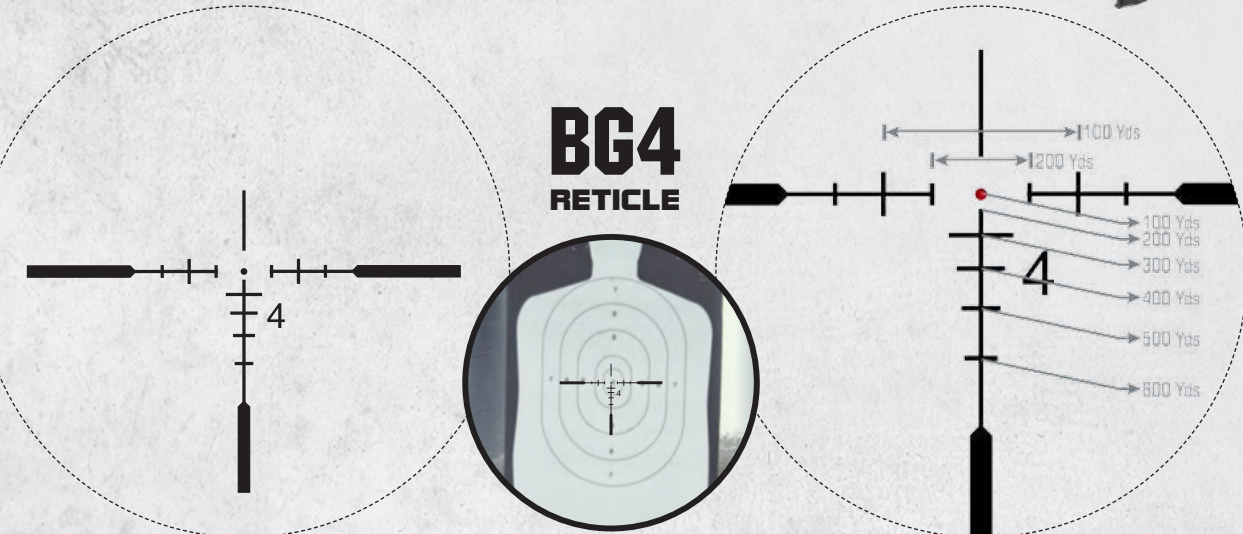

**THE BG4** Reticle is designed to be fast and intuitive to use and features ballistic drop compensation and rangefinder markings out to 600 yards. The ballistic data is based on common 5.56/.223 loadings in modern sporting rifles. The three thick posts draw the eye to the center for rapid acquisition at close range, while the drop compensation allows for rapid engagement of targets throughout the platform's effective range.

Model #	SCP3-18IEBG4	SCP3-18IEMDQ	SCP3-18IECDQ	SCP3-216AIEW	SCP3-216UMOA	SCP3-216G4
Magnification	1x-8x	1x-8x	1x-8x	2x-16x	2x-16x	2x-16x
Tube Diameter	30mm	30mm	30mm	30mm	30mm	30mm
Objective Diameter	28mm	28mm	28mm	44mm	44mm	44mm
Field of View @100 Yards	99.5 - 13'	99.5 - 13'	99.5 - 13'	44.5' - 6.3'	44.5' - 6.3'	44.5' - 6.3'
Eye Relief	5 - 3.35"	5 - 3.35"	5 - 3.35"	4.1 - 3.5"	4.1 - 3.5"	4.1 - 3.5"
Exit Pupil	26.5 - 3.4mm	26.5 - 3.4mm	26.5 - 3.4mm	22 - 2.7mm	22 - 2.7mm	22 - 2.7mm
Click Value @100 Yards	1/2"	1/2"	1/2"	1/4"	1/4"	1/4"
Length	10.25"	10.25"	10.25"	12.37"	12.37"	12.37"
Weight	18oz	18oz	18oz	22.6oz	22.6oz	22.6oz
Parallax Setting	100 Yds	100Yds	100Yds	10Yds - Infinity	10Yds - Infinity	10Yds - Infinity
Rings	AIR32234 (P.051)	RQ2W3154 (P.055)	RQ2W3154 (P.055)	RQ2W3154 (P.055)	RQ2W3154 (P.055)	RQ2W3154 (P.055)
Batteries	CR2032 3V	CR2032 3V	CR2032 3V	CR2032 3V	CR2032 3V	CR2032 3V



# ACCUSHOT® T4 TACTICAL SERIES

## COMPACT PRISMATIC OPTICS

Please refer to P.017 for details.

- TS** TRUE STRENGTH® PLATFORM
- PRISMATIC REFRACTION
- IE 36 COLOR ILLUMINATION
- BROADBAND MULTI-COATING
- FLIP-OPEN LENS CAPS
- ZERO L/R TURRETS
- TWIST LOCK MOUNTING BASE

### PARTS INCLUDED

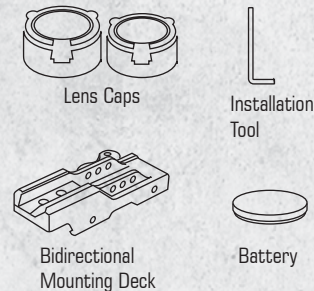

T4 prismatic scopes combine an impressive array of high-performance features into rugged, compact packages. The prism-based design allows for a more compact optical system without sacrificing optical quality. IE® 36-color illuminated reticles are etched directly on the prism to ensure consistent point-of-aim at all times.

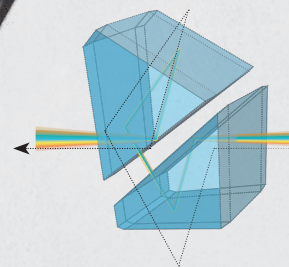

### ADVANCED PRISMATIC DESIGN

Sophisticated prismatic design provides a super compact optical system without sacrificing optical quality. The distance light needs to travel is achieved after multiple refractions are completed inside the prism.

# 50% SHORTER

### MORE COMPACT IN SIZE

Prismatic design dramatically shortens the T4 series optics. They are half the length comparing to other traditional 4X powered optics in the market.



**IE**  
ETCHED  
GLASS  
RETICLE

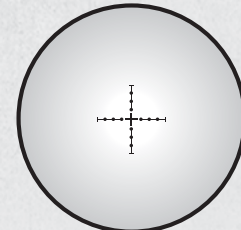

PARALLAX PRESET AT 100 YDS  
**4X32**

34MM SCP-T4IEMDQ

ACCUSHOT® Compact Prismatic T4 4x32 Mil-dot Reticle Scope

**IE**  
ETCHED  
GLASS  
RETICLE

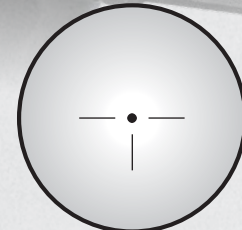

PARALLAX PRESET AT 100 YDS  
**4X32**

34MM SCP-T4IETDQ

ACCUSHOT® Compact Prismatic T4 4x32 T-dot Reticle Scope

**IE**  
ETCHED  
GLASS  
RETICLE



PARALLAX PRESET AT 100 YDS  
**4X32**

34MM SCP-T4IECDQ

ACCUSHOT® Compact Prismatic T4 4x32 Circle Dot Reticle Scope



Model #	SCP-T4IEMDQ	SCP-T4IECDQ	SCP-T4IETDQ
Magnification	4x	4x	4x
Tube Diameter	34mm	34mm	34mm
Objective Diameter	32mm	32mm	32mm
Field of View @100 Yards	27'	27'	27'
Eye Relief	2.3"	2.3"	2.3"
Exit Pupil	8mm	8mm	8mm
Click Value @100 Yards	1/4"	1/4"	1/4"
Length	5.5"	5.5"	5.5"
Weight	19.5oz	19.5oz	19.5oz
Parallax Setting	100Yds	100Yds	100Yds
Mounting Base	Bidirectional Integral QD Mount	Bidirectional Integral QD Mount	Bidirectional Integral QD Mount
Batteries	CR1632	CR1632	CR1632





# ACCUSHOT® TACTICAL SERIES

FOR WHEN PRECISION & SPEED COUNTS

Please refer to **P.017** for details.

- TS** TRUE STRENGTH® PLATFORM
- IE** 36 COLOR ILLUMINATION
- BROADBAND MULTI-COATING
- 30mm** 30MM 1-PIECE MAIN TUBE
- RINGS & LENS CAPS
- ZERO L/R TURRETS
- ANGLED INTEGRAL SUNSHADE

### PARTS INCLUDED

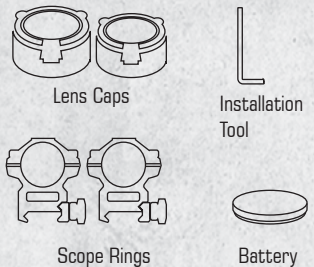

### COMPATIBLE ITEMS



Featuring a 30mm 1-piece main tube and 3 choices of illuminated reticles (Circle Dot, Wire or Etched Glass Mil-dot), the Tactical Series offers a rich selection of features for any shooting situation. Our Tactical Series will give you years of dependable service with their rugged construction and proven design.

**ETCHED GLASS RETICLE**  
PARALLAX PRESET AT 100 YDS  
**1-4.5X28**  
30MM SCP3-145IEMDQ  
ACCUSHOT® 30mm 1-4.5x28 CQB Mil-dot Reticle Scope

**ETCHED GLASS RETICLE**  
PARALLAX PRESET AT 100 YDS  
**1-4.5X28**  
30MM SCP3-145IECDQ  
ACCUSHOT® 30mm 1-4.5x28 CQB Circle Dot Reticle Scope

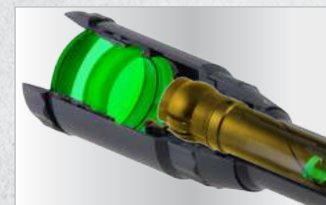

Smart Spherical Structure Design for Optimal Zero Hold Under Recoil

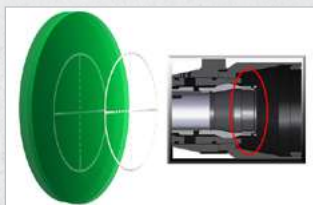

Some Models Available with Wire Reticles



Side Wheel Adjustable Turret Models Compatible with Add-on Big Wheel (Sold Separately)

**ETCHED GLASS RETICLE**  
10 YDS TO INFINITY  
**3-12X44**  
30MM SCP3-UGM312AOIEW  
ACCUSHOT® 30mm 3-12x44 Compact Mil-dot Reticle Scope

**ETCHED GLASS RETICLE**  
10 YDS TO INFINITY  
**4-16X44**  
30MM SCP3-UGM416AOIEW  
ACCUSHOT® 30mm 4-16x44 Compact Mil-dot Reticle Scope

**ETCHED GLASS RETICLE**  
PARALLAX PRESET AT 100 YDS  
**1.5-6X44**  
30MM SCP3-UG156IEW  
ACCUSHOT® 30mm 1.5-6x44 Mil-dot Reticle Scope

**ETCHED GLASS RETICLE**  
10 YDS TO INFINITY  
**10X44**  
30MM SCP3-UGM104AOIEW  
ACCUSHOT® 30mm 10x44 Compact Mil-dot Reticle Scope

**WIRE RETICLE**  
10 YDS TO INFINITY  
**3-12X44**  
30MM SCP3-UM312AOIEW  
ACCUSHOT® 30mm 3-12x44 Compact Mil-dot Reticle Scope

**WIRE RETICLE**  
10 YDS TO INFINITY  
**4-16X44**  
30MM SCP3-UM416AOIEW  
ACCUSHOT® 30mm 4-16x44 Compact Mil-dot Reticle Scope

**WIRE RETICLE**  
PARALLAX PRESET AT 100 YDS  
**1.5-6X44**  
30MM SCP3-U156IEW  
ACCUSHOT® 30mm 1.5-6x44 Mil-dot Reticle Scope

Model #	SCP3-145IECDQ	SCP3-145IEMDQ	SCP3-UGM312AOIEW	SCP3-UM312AOIEW	SCP3-UGM416AOIEW	SCP3-UM416AOIEW	SCP3-UGM104AOIEW	SCP3-UG156IEW	SCP3-U156IEW
Magnification	1x-4.5x	1x- 4.5x	3x-12x	3x-12x	4x-16x	4x-16x	10x	1.5x-6x	1.5x-6x
Tube Diameter	30mm	30mm	30mm	30mm	30mm	30mm	30mm	30mm	30mm
Objective Diameter	28mm	28mm	44mm	44mm	44mm	44mm	44mm	44mm	44mm
Field of View @100 Yards	106' - 28'	106' - 28'	32.0' - 10.0'	32.0' - 10.0'	26.2' - 7.85'	26.2' - 7.85'	11.4'	57.6' - 17.3'	57.6' - 17.3'
Eye Relief	4.5" - 3.0"	4.5" - 3.0"	3.4" - 3.0"	3.4" - 3.0"	3.4" - 3.0"	3.4" - 3.0"	3.2"	3.9" - 3.0"	3.9" - 3.0"
Exit Pupil	27 - 6mm	27 - 6mm	13.0 - 3.9mm	13.0 - 3.9mm	11 - 2.7mm	11 - 2.7mm	5mm	17.2 - 7.3mm	17.2 - 7.3mm
Click Value @100 Yards	1/2"	1/2"	1/4"	1/4"	1/4"	1/4"	1/4"	1/4"	1/4"
Length	8.8"	8.8"	11.1"	11.1"	11.2"	11.2"	10.6"	13.2"	13.2"
Weight	16.8oz	16.8oz	23.2oz	23.2oz	21.8oz	21.8oz	21.9oz	22.8oz	22.8oz
Parallax Setting	100Yds	100Yds	10Yds - Infinity	10Yds - Infinity	10Yds to Infinity	10Yds to Infinity	10Yds - Infinity	100Yds	100Yds
Rings	RQ2W3104 (P.055)	RQ2W3104 (P.055)	RG2W3154 (P.055)	RG2W3154 (P.055)	RG2W3154 (P.055)	RG2W3154 (P.055)	RG2W3154 (P.055)	RG2W3154 (P.055)	RG2W3154 (P.055)
Batteries	CR2032 3V	CR2032 3V	CR2032 3V	CR2032 3V	CR2032 3V	CR2032 3V	CR2032 3V	CR2032 3V	CR2032 3V

Please refer to **P.017** for details.

- TS** TRUE STRENGTH® PLATFORM
- IE** 36 COLOR ILLUMINATION
- BROADBAND MULTI-COATING
- RINGS & LENS CAPS
- ZERO L/R TURRETS

**PARTS INCLUDED**

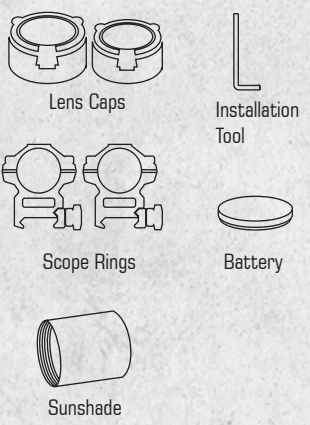

**COMPATIBLE ITEMS**

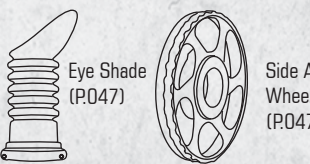

Built from a 1 inch main tube, these are just as rugged as our tactical scopes. They all feature a Mil-dot reticle along with Zero Locking/Resetting Turrets in a compact and lightweight package. Bugbuster® scope fans now get to enjoy the UTG® exclusive 36-color IE® reticle or Side Wheel Parallax Adjustment.

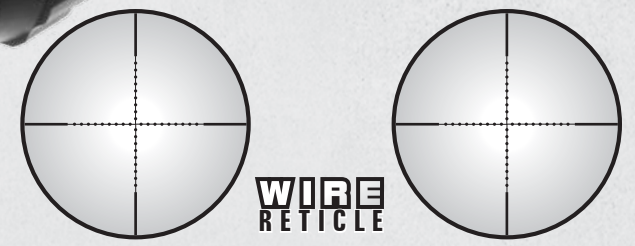

**3 YDS TO INFINITY**  
**3-12X32**  
**3 YDS TO INFINITY**  
**3-9X32**

**1" SCP-M312AOWQ**  
Bugbuster® 1 inch 3-12x32 AO Compact Mil-dot Reticle Scope with Picatinny Rings

**1" SCP-M392AOD**  
Bugbuster® 1 inch 3-9x32 AO Compact Mil-dot Reticle Scope with Dovetail Rings

**1" SCP-M312AOD**  
Bugbuster® 1 inch 3-12x32 AO Compact Mil-dot Reticle Scope with Dovetail Rings



Side Wheel Adjustable Turret Models Compatible with Add-on Big Wheel (Sold Separately)



Zero Locking/Resetting Target Turrets



Compact 8 Inch Overall Length



**IE® WIRE RETICLE**  
**3 YDS TO INFINITY**  
**3-9X32**

**1" SCP-M392AOIEWQ**  
Bugbuster® 1 inch 3-9x32 AO Compact Mil-dot Reticle Scope



**RGB WIRE RETICLE**  
**3 YDS TO INFINITY**  
**3-9X32**

**1" SCP-M392AOLWQ**  
Bugbuster® 1 inch 3-9x32 AO Compact Mil-dot Reticle Scope



**IE® WIRE RETICLE**  
**PARALLAX PRESET AT 100 YDS**  
**4X32**

**1" SCP-M432IEWQ**  
Bugbuster® 1 inch 4x32 Compact Mil-dot Reticle Scope

Model #	SCP-M312AOWQ	SCP-M312AOD	SCP-M392AOD	SCP-M392AOIEWQ	SCP-M392AOLWQ	SCP-M432IEWQ
Magnification	3x-12x	3x-12x	3x-9x	3x-9x	3x-9x	4x
Tube Diameter	1"	1"	1"	1"	1"	1"
Objective Diameter	32mm	32mm	32mm	32mm	32mm	32mm
Field of View @100 Yards	31' - 10'	31' - 10'	36.6' - 12.5'	37.7' - 14'	37.7' - 14'	27.2'
Eye Relief	4.3" - 3.3"	4.3" - 3.3"	4.25" - 3.3"	4.2" - 3.2"	4.2" - 3.2"	3.8"
Exit Pupil	10.6 - 2.7mm	10.6 - 2.7mm	10.6 - 3.6mm	10.6 - 3.6mm	10.6 - 3.6mm	8mm
Click Value @100 Yards	1/3"	1/3"	1/3"	1/4"	1/4"	1/4"
Length	8.1"	8.1"	7.9"	8.2"	8.2"	8.2"
Weight	12.7oz	12.7oz	12oz	14oz	14oz	12.3oz
Parallax Setting	3Yds - Infinity	3Yds - Infinity	3yds - infinity	3Yds - Infinity	3Yds - Infinity	100Yds
Rings	RQ2W1154 (P.055)	RT2D1154	RT2D1154	RQ2W1154 (P.055)	RQ2W1154 (P.055)	RQ2W1154 (P.055)
Batteries	N/A	N/A	N/A	CR1632 3V	CR1620 3V	CR1632 3V

**UTG® TRUE HUNTER™ IE® SERIES**  
A STAPLE OPTIC FOR HUNTING

Please refer to **P.017** for details.

- TS** TRUE STRENGTH® PLATFORM
- IE 36 COLOR ILLUMINATION
- BROADBAND MULTI-COATING
- 1 INCH 1-PIECE MAIN TUBE
- RINGS & LENS CAPS
- ZERO L/R TURRETS
- SUNSHADE INCLUDED

**PARTS INCLUDED**

- Lens Caps
- Installation Tool
- Scope Rings
- Battery

- Sunshade (50mm Objective Scopes Only)

**COMPATIBLE ITEMS**

- Eye Shade (P.047)

All True Hunter Scopes are equipped with the EZ-TAP® 36 IE® Technology feature to provide both Red/Green and 36 color IE® illumination. Max Strength rings and flip-open lens caps are also included.



Smart Spherical Structure Design for Optimal Zero Hold Under Recoil



Dual and 36 Multi-color Reticle Illumination



Broadband Multi-coating for Optimal Light Transmission

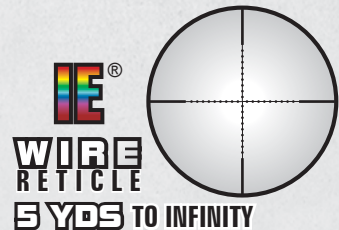

1" SCP-U395AOIEW  
True Hunter™ 1 inch 3-9x50 Full-size Mil-dot Reticle Scope



1" SCP-U4164AOIEW  
True Hunter™ 1 inch 4-16x40 Full-size Mil-dot Reticle Scope



1" SCP-U416AOIEN  
True Hunter™ 1 inch 4-16x40 Full-size Mil-dot Reticle Scope

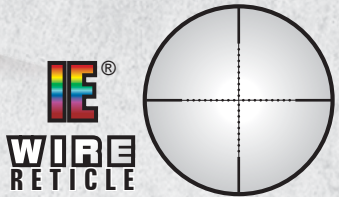

1" SCP-U312AOIEW  
True Hunter™ 1 inch 3-12x40 Full-size Mil-dot Reticle Scope

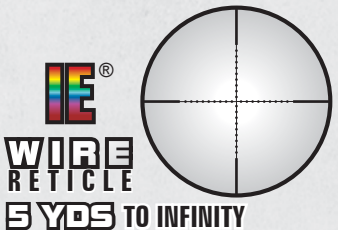

1" SCP-U394AOIEW  
True Hunter™ 1 inch 3-9x40 Full-size Mil-dot Reticle Scope

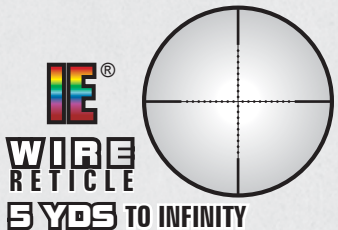

1" SCP-U394AOIED  
True Hunter™ 1 inch 3-9x40 Full-size Mil-dot Reticle Scope with Dovetail Rings

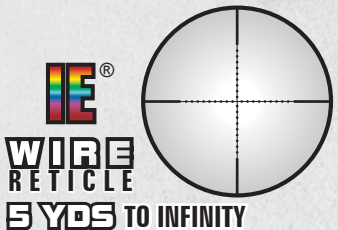

1" SCP-U4165AOIEW  
True Hunter™ 1 inch 4-16x50 Full-size Mil-dot Reticle Scope

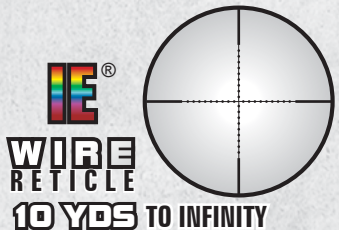

1" SCP-U6245AOIEW  
True Hunter™ 1 inch 6-24x50 Full-size Mil-dot Reticle Scope

Model #	SCP-U6245AOIEW	SCP-U4165AOIEW	SCP-U4164AOIEW	SCP-U4164AOIEN	SCP-U312AOIEW	SCP-U395AOIEW	SCP-U394AOIEW	SCP-U394AOIED
Magnification	6x-24x	4x-16x	4x-16x	4x-16x	3x-12x	3x-9x	3x-9x	3x-9x
Tube Diameter	1"	1"	1"	1"	1"	1"	1"	1"
Objective Diameter	50mm	50mm	40mm	40mm	40mm	50mm	40mm	40mm
Field of View @100 Yards	14.4' - 4.1'	23.0' - 6.0'	23.0' - 6.0'	23.0' - 6.0'	34.0' - 8.5'	35.6' - 12'	35.6' - 12'	35.6' - 12'
Eye Relief	3.2" - 3.0"	3.2" - 3.0"	3.2" - 3.0"	3.2" - 3.0"	3.2" - 2.9"	3.9" - 3.2"	3.9" - 3.2"	3.9" - 3.2"
Exit Pupil	8.3 - 2.2mm	12.5 - 2.5mm	10.0 - 2.5mm	10.0 - 2.5mm	13.1 - 3.3mm	16 - 5.5mm	13 - 4.5mm	13 - 4.5mm
Click Value @100 Yards	1/4"	1/4"	1/4"	1/4"	1/4"	1/4"	1/4"	1/4"
Length	15.2"	14.9"	14.5"	14.5"	13"	12.9"	12.6"	12.6"
Weight	26.5oz	25.7oz	22.3oz	22.3oz	21.9oz	24.8oz	21.1oz	21.1oz
Parallax Setting	10Yds - Infinity	5Yds - Infinity	5Yds - Infinity	5Yds - Infinity	5Yds - Infinity	5Yds - Infinity	5Yds - Infinity	5Yds - Infinity
Rings	RG2W1204 (P.055)	RG2W1204 (P.055)	RGWM-25H4 (P.057)	N/A	RG2W1204 (P.055)	RG2W1204 (P.055)	RG2W1204 (P.055)	RGPM-25M4 (P.057)
Batteries	CR2032 3V	CR2032 3V	CR2032 3V	CR2032 3V	CR2032 3V	CR2032 3V	CR2032 3V	CR2032 3V



# UTG® TRUE HUNTER™ CLASSIC SERIES

MINIMALIST INSPIRED DESIGNS AND FUNCTIONS

Please refer to P.017 for details.

**TS** TRUE STRENGTH® PLATFORM

**R** RINGS & LENS CAPS

**T** 1 INCH 1-PIECE MAIN TUBE

This line features our TF2+ windage and elevation turrets on some of the most popular magnification powers and objective lens sizes. Our basic hunting scopes offer features found on other premium brand scopes, yet are affordable from LEAPERS UTG.

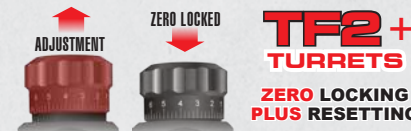
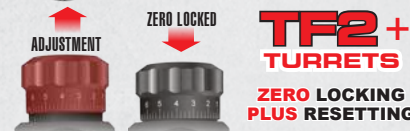
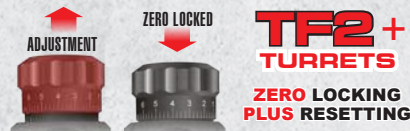

**WIRE RETICLE**  
5 YDS TO INFINITY  
**4X32**  
1" SCP-U432AOWT2  
True Hunter™ 1 inch 4x32 AO Full Size Mil-dot Reticle Scope with Picatinny Rings



**WIRE RETICLE**  
PARALLAX PRESET AT 100 YDS  
**3-9X40**  
1" SCP-U394FWT2  
True Hunter™ 1 inch 3-9x40 Full Size Mil-dot Reticle Scope with Picatinny Rings



**WIRE RETICLE**  
PARALLAX PRESET AT 35 YDS  
**3-9X40**  
1" SCP-U394FDT2  
True Hunter™ 1 inch 3-9x40 Full Size Mil-dot Reticle Scope with Dovetail Rings

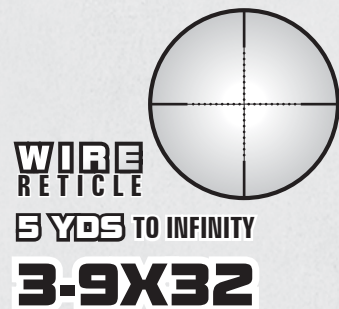

**WIRE RETICLE**  
5 YDS TO INFINITY  
**3-9X32**  
1" SCP-U392AODT2  
True Hunter™ 1 inch 3-9x32 AO Full Size Mil-dot Reticle Scope with Dovetail Rings

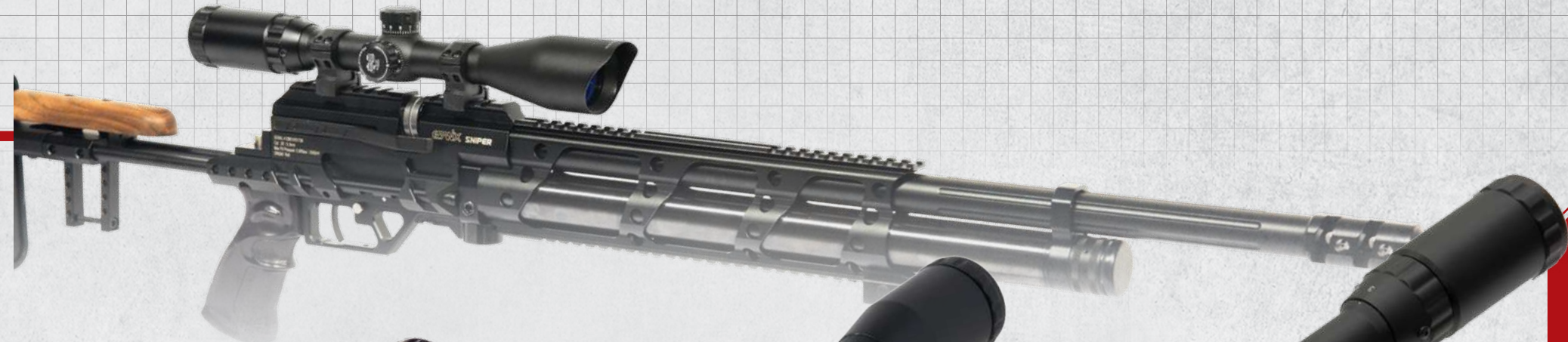

**WIRE RETICLE**  
PARALLAX PRESET AT 100 YDS  
**4X32**  
1" SCP-U432M1  
True Hunter™ 1 inch 4x32 Compact Size Mil-dot Reticle Scope



**WIRE RETICLE**  
100 YDS -PRESET PARALLAX -35 YDS  
**4X32**  
1" SCP-U432FW  
True Hunter™ 1 inch 4x32 Full Size Mil-dot Reticle Scope with Picatinny Rings



**WIRE RETICLE**  
PARALLAX PRESET AT 35 YDS  
**3-9X32**  
1" SCP-U392RGD  
True Hunter™ 1 inch 3-9x32 Full Size Mil-dot Reticle Scope with Dovetail Rings

Model #	SCP-U432AOWT2	SCP-U432FW	SCP-U432FD	SCP-U432M1	SCP-U394FWT2	SCP-U394FDT2	SCP-U392AODT2	SCP-U392RGD
Magnification	4x	4x	4x	4x	3x-9x	3x-9x	3x-9x	3x-9x
Tube Diameter	1"	1"	1"	1"	1"	1"	1"	1"
Objective Diameter	32mm	32mm	32mm	32mm	40mm	40mm	32mm	32mm
Field of View @100 Yards	32'	32'	32'	24'	35.6' - 12'	35.6' - 12'	35.6' - 12'	35.6' - 12'
Eye Relief	3.4"	3.4"	3.4"	3.2"	3.9" - 3.2"	3.9" - 3.2"	3.9" - 3.2"	4.1" - 3.5"
Exit Pupil	8.0mm	8.0mm	8.0mm	8.0mm	13 - 4.5mm	13 - 4.5mm	13 - 4.5mm	10.6 - 3.2mm
Click Value @100 Yards	1/4"	1/4"	1/4"	1/4"	1/4"	1/4"	1/4"	1/4"
Length	11.9"	11.8"	11.8"	8.2"	13.1"	13.1"	12.2"	13.1"
Weight	16.5oz	14.4oz	14.4oz	9.4oz	18.7oz	18.7oz	18.3oz	15.7oz
Parallax Setting	5Yds to Infinity	100Yds	35Yds	100Yds	100Yds	35Yds	5Yds to Infinity	35Yds
Rings	RG2W1154 (P.055)	RGWM-25M4 (P.057)	RGPM-25M2	RGWM-25L2 (P.057)	RG2W1154 (P.055)	RGPM-25M4 (P.057)	RGPM-25M4 (P.057)	RGPM-25M4 (P.057)
Batteries	N/A	N/A	N/A	N/A	N/A	N/A	N/A	CR1620 3V

**REFLEX MICRO DOT**  
**COMPACT 2.0" BODY**

- Precision Machined from Aircraft Aluminum with a Matte Black Finish
- 4 MOA Illuminated Single Dot with 6 Variable Brightness Settings
- 1-Click Illumination Memory Feature Gets the User Right Back to the Brightness Setting Last Used
- Windage and Elevation Adjustable with 1 MOA/Click Adjustment at 100 Yds
- Adaptive Mount Base Includes Universal MIL-STD-1913 Picatinny Mount and is Compatible with Glock MOS #1, #5, S&W CORE™ #5 Plates, and Other Equivalently Manufactured Plates
- Multi-applicative Towards a Wide Variety of Different Firearms

Compatible with Glock MOS #1, #5, and S&W CORE™ #5 Plates, and Other Equivalently Manufactured Plates



**RED 4 MOA SINGLE DOT**

SCP-RDM20R  
2.0" Reflex Micro Dot with Red Single Dot & Adaptive Mounting Base



**GREEN 4 MOA SINGLE DOT**

SCP-RDM20G  
2.0" Reflex Micro Dot with Green Single Dot & Adaptive Mounting Base



Absolute Co-Witness with Iron Sights

**RG CIRCLE DOT**

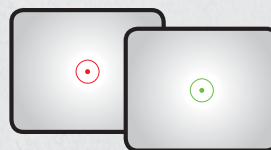

SCP-RDM39CDQ  
3.9" Reflex Sight with R/G Illuminated Circle Dot & Integral Twist Lock Mount Base

**RG 4 MOA SINGLE DOT**

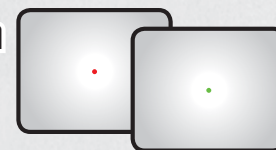

SCP-RDM39SDQ  
3.9" Reflex Sight with R/G Illuminated Single Dot & Integral Twist Lock Mount Base

Model #	SCP-RDM39CDQ	SCP-RDM39SDQ	SCP-RDM20R	SCP-RDM20G	SCP-MF3WEQS
Magnification	1x	1x	1x	1x	3x
Tube Diameter	N/A	N/A	N/A	N/A	44mm
Objective Diameter	34 X 25mm	34 X 25mm	23x17mm	23x17mm	25mm
Field of View @100 Yards	---	---	---	---	45'
Eye Relief	Unlimited	Unlimited	Unlimited	Unlimited	2"
Exit Pupil	---	---	---	---	8.7mm
Click Value @100 Yards	1"	1"	1"	1"	N/A
Center Height	37mm	37mm	15.5mm (20mm W/ Mounting Base)	42mm	
Length	3.9"	3.9"	2"	2"	4"
Weight	8.64oz	8.64oz	1.12oz	1.12oz	11.82oz
Batteries	AG5 X2	AG5 X2	CR2032 3V	CR2032 3V	N/A



Center Height (42mm)

- US PAT. D672,839
- US PAT. 8,397,421
- EU PAT. 001984576-0001

**3X FLIP-TO-SIDE MAGNIFIER**

SCP-MF3WEQS  
3X QD Flip-to-Side Magnifier with Locking Windage/Elevation Adjustment

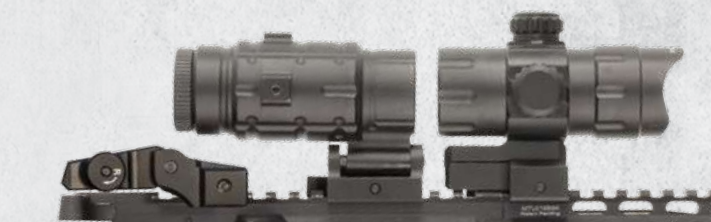

**MAGNIFIER COMPATIBILITY CHART**

Perfect Match	Match W/ 0.75"/0.59"/0.5" Riser	Match W/ 0.83" Riser
SCP-TDTDQ	SCP-RD40RGW-A	SCP-RDM20R
SCP-TDSDQ	SCP-RD40SDQ	SCP-RDM20G
SCP-DS3840W	SCP-RD40CDQ	Check out Magnifier & Dot Sight cross-reference table at
SCP-DS3039W	SCP-DS3028W	
SCP-DS3840TDQ	SCP-DS3026W	
SCP-RDM39SDQ	SCP-DS3068W	
SCP-RDM39CDQ	SCP-DS3068TDQ	

Please refer to **P.017** for details.

**TS** TRUE STRENGTH® PLATFORM

**∞** UNLIMITED EYE RELIEF

**US PAT. 8,397,421**

UTG® offers the widest selection of dot sights for any and every close quarters scenario. Need mounts of different heights? Versatile mounting solutions? Is quick detach deployment a must? We have considered them all!

**NEW**  
**RED 4 MOA SINGLE DOT**

OP-DS2521R

2.5" Mini Dot Sight with Red Single Dot & Absolute Co-witness Mount

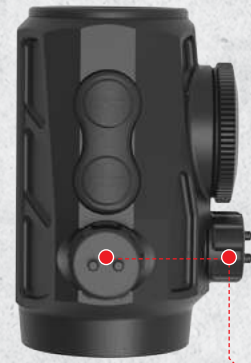

Covered Windage and Elevation Adjustment Turrets with Keyed Caps

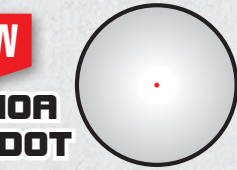

7 Power Intensity Settings with 1-Click Illumination Memory



Absolute Co-witness Mount

T1 Compatible Base Interface



IPX7 Waterproof Rated



Utilizes Locking Torx Screws and Square-shaped Integral Recoil Stops for Secure Zero Hold



Low Profile Design with Base for Reduced Weight and Bulk



Lockable W/E Target Turrets

RG Illumination

Quick Detach Lever Lock

Bidirectional Offset Mount Included



**RG T-DOT**

SCP-TDTDQ

6" RG T-dot Sight with Bidirectional QD Mount

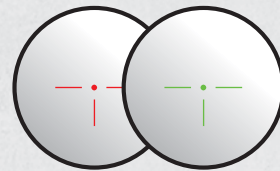

**RG 4 MOA SINGLE DOT**

SCP-TDSDQ

6" RG Single Dot Sight with Bidirectional QD Mount

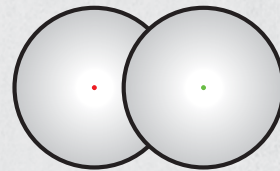

**RG 4 MOA SINGLE DOT**

SCP-DS3026W

2.6" RG Single Dot Sight with Integral QD Base

**RG 4 MOA SINGLE DOT**

SCP-DS3039W

3.9" RG Single Dot Sight with Offset Riser & QD Mount

**RG 4 MOA SINGLE DOT**

SCP-RD40RGW-A

3.8" RG Single Dot Sight with Integral QD Base

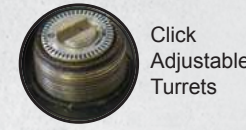

Click Adjustable Turrets



Double Lock Turrets

Offset Riser Included



Offset Riser Applications



Click Adjustable Turrets



**RG T-DOT**

SCP-DS3840TDQ

4.2" RG T-dot Sight with Offset Riser & QD Mount



**RG T-DOT**

SCP-DS3068TDQ

6.4" RG T-dot Sight with Max Strength QD Mount

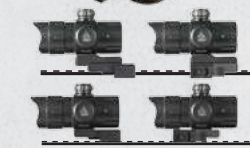

Offset Riser Applications



Double Lock Turrets

One-piece Scope Mount Included

**RG 4 MOA SINGLE DOT**

SCP-DS3840W

4.2" RG Single Dot Sight with Offset Riser & QD Mount

**RG 4 MOA SINGLE DOT**

SCP-DS3068W

6.4" RG Single Dot Sight with Max Strength QD Mount



**RG 4 MOA SINGLE DOT**

SCP-RG40SDQ

3.8" RG Single Dot Sight with Integral QD Base



Click Adjustable Turrets

**RG CIRCLE DOT**

SCP-RG40CDQ

3.8" RG Circle Dot Sight with Integral QD Base

Model #	OP-DS2521R	SCP-TDTDQ	SCP-TDSDQ	SCP-DS3068W	SCP-DS3068TDQ	SCP-DS3840W	SCP-DS3840TDQ	SCP-DS3026W	SCP-DS3039W	SCP-RD40RGW-A	SCP-RG40SDQ	SCP-RG40CDQ
Magnification	1x	1x	1x	1x	1x	1x	1x	1x	1x	1x	1x	1x
Tube Diameter	33mm	38mm	38mm	30mm	30mm	38mm	38mm	30mm	30mm	38mm	38mm	38mm
Objective Diameter	21mm	39mm	39mm	30mm	30mm	32mm	32mm	21mm	26mm	30mm	30mm	30mm
Field of View @100 Yards	85'	85'	85'	63'	63'	103'	103'	95'	75'	95'	95'	95'
Eye Relief	Unlimited	Unlimited	Unlimited	Unlimited	Unlimited	Unlimited	Unlimited	Unlimited	Unlimited	Unlimited	Unlimited	Unlimited
Exit Pupil	21mm	26mm	26mm	21mm	21mm	22mm	22mm	21mm	21mm	22mm	22mm	22mm
Click Value @100 Yards	1"	1/2"	1/2"	1/2"	1/2"	1/2"	1/2"	1/2"	1/2"	1/2"	1/2"	1/2"
Center Height	35mm	42mm	42mm	25mm	25mm	32mm(42mm w/ riser)	25mm	30mm(40mm w/ riser)	25.5mm	25.5mm	25.5mm	25.5mm
Length	2.5"	6"	6"	6.4"	6.4"	4.2"	4.2"	2.6"	3.9"	3.8"	3.8"	3.8"
Weight	5.2oz	13.1oz	13.1oz	12.1oz	12.1oz	8.7oz	8.7oz	4.9oz	8.3oz	9.4oz	8.4oz	8.4oz
Batteries	CR1620	CR1620	CR1620	CR1620 3V	CR1620 3V	CR1620 3V	CR1620 3V	CR1620 3V	CR1620 3V	CR2032 3V	CR2032 3V	CR2032 3V



# UTG® AIR RIFLE SCOPES & ACCESSORIES

CAREFULLY SELECTED FOR AIRGUNNERS



**ETCHED GLASS RETICLE**



**PAGE 022**  
FOR DETAILS

10 YDS TO INFINITY  
**4-16X56**

30MM SCP3-UG4165A0IEW  
ACCUSHOT® 30mm 4-16x56  
Bubble Leveler Mil-dot Reticle Scope



**ETCHED GLASS RETICLE**

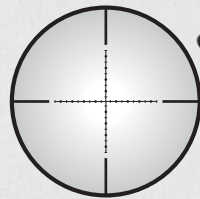

**PAGE 023**  
FOR DETAILS

10 YDS TO INFINITY  
**4-16X56**

30MM SCP3-UG4165A0IEW  
ACCUSHOT® 30mm 4-16x56 Mil-dot  
Reticle Scope



**ETCHED GLASS RETICLE**

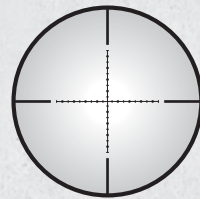

**PAGE 023**  
FOR DETAILS

10 YDS TO INFINITY  
**6-24X56**

30MM SCP3-UG6245A0IEW  
ACCUSHOT® 30mm 6-24x56 Mil-dot  
Reticle Scope



**ETCHED GLASS RETICLE**

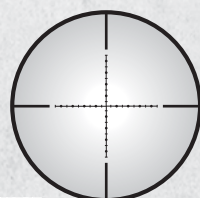

**PAGE 025**  
FOR DETAILS

10 YDS TO INFINITY  
**3-12X44**

30MM SCP3-UG312A0IEW  
ACCUSHOT® 30mm 3-12x44  
Mil-dot Reticle Scope



**ETCHED GLASS RETICLE**



**PAGE 029**  
FOR DETAILS

10 YDS TO INFINITY  
**2-16X44**

30MM SCP3-216UMOA  
ACCUSHOT® 30mm 2-16x44 MRC  
(Multi-range Combat & Competition)  
UMOA Reticle Scope



**PAGE 047**  
FOR DETAILS

### SIDE AO WHEEL

- SCP-SW060B
- SCP-SW080B
- SCP-SW100B
- SCP-SW080BB
- SCP-SW100BL



**WIRE RETICLE**

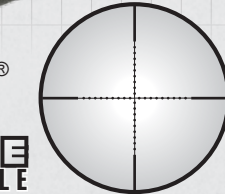

**PAGE 037**  
FOR DETAILS

3 YDS TO INFINITY  
**4-16X40**

1" SCP-U416A0IEN  
True Hunter™ 1 inch 4-16x40 Full-size  
Mil-dot Reticle Scope



**WIRE RETICLE**

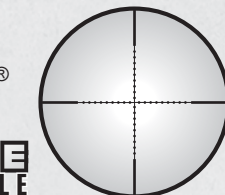

**PAGE 037**  
FOR DETAILS

3 YDS TO INFINITY  
**3-9X40**

1" SCP-U394A0IED  
True Hunter™ 1 inch 3-9x40 Full-size  
Mil-dot Reticle Scope with Dovetail Rings



**WIRE RETICLE**



**PAGE 034**  
FOR DETAILS

3 YDS TO INFINITY  
**3-12X32**

1" SCP-M312A0D  
Bugbuster® 1 inch 3-12x32 AO  
Compact Mil-dot Reticle Scope with  
Dovetail Rings



**WIRE RETICLE**

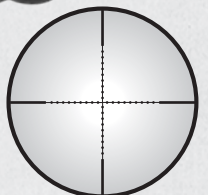

**PAGE 038**  
FOR DETAILS

3 YDS TO INFINITY  
**3-9X32**

1" SCP-U392A0DT2  
True Hunter™ 1 inch 3-9x32 AO Full Size  
Mil-dot Reticle Scope with Dovetail Rings



**WIRE RETICLE**

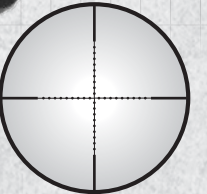

**PAGE 034**  
FOR DETAILS

3 YDS TO INFINITY  
**3-9X32**

1" SCP-M392A0D  
Bugbuster® 1 inch 3-9x32 AO  
Compact Mil-dot Reticle Scope  
with Dovetail Rings



**WIRE RETICLE**

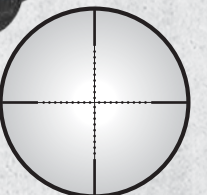

**PAGE 039**  
FOR DETAILS

PARALLAX PRESET AT 35 YDS  
**4X32**

1" SCP-U432FD  
True Hunter™ 1 inch 4x32 Full Size  
Mil-dot Reticle Scope with Dovetail Rings

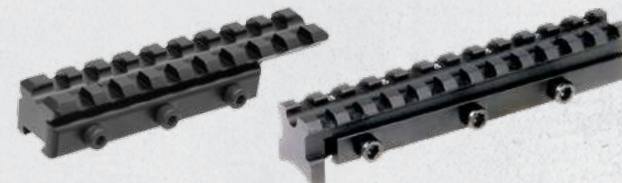

**PAGE 099**  
FOR DETAILS

**REFER TO AIR RIFLE  
MOUNTS AND ADAPTORS**

Please refer to P.017 for details.

- TS** TRUE STRENGTH® PLATFORM
- RGB** RED/GREEN/BLACK RETICLE
- RINGS & LENS CAPS**



**RGB PDC RETICLE**

**PARALLAX PRESET AT 33 YDS**

**2-7X32**

1" SCP-27PRGW  
1 inch 2-7x32 RGB PDC Reticle Handgun Scope

**25"-13.8"**  
EXTENDED LONG EYE RELIEF

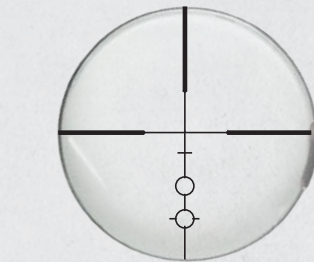

The Projectile Drop Compensation (PDC) reticle features four posts advancing from the outer edge of the reticle space towards the center, from the 3, 6, 9, and 12 O'clock positions. The four posts transition to a finer post thickness at the center of the crosshair, quickly focusing the eye towards the center and on target. The 6 O'clock post features four drop compensation points, providing the shooter with quick holdovers for their predetermined cartridge ballistics. The PDC reticle features a red/green dual-color mode which can be activated when lighting conditions require it.



**PRO 5-STEP RETICLE**

**PARALLAX PRESET AT 50 YDS**

**4X32**

1" SCP-M4CR5WQ  
1 Inch 4x32 Pro 5-step Reticle Crossbow Scope

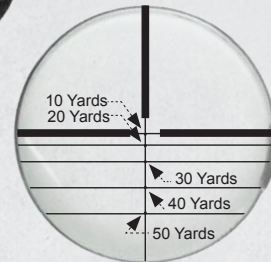

Model #	SCP-27PRGW	SCP-M4CR5WQ
Magnification/FPS Compensation	2x-7x	4x
Tube Diameter	1"	1"
Objective Diameter	32mm	32mm
Field of View @100 Yards	19.2' - 7'	27.2'
Eye Relief	25" - 13.8"	3.8"
Exit Pupil	16 - 5mm	8mm
Click Value @100 Yards	1/4"	1/4"
Length	9.4"	8.2"
Weight	14oz	12.3oz
Parallax Setting	35Yds	50Yds
Rings	RGWM-25M4 (P057)	RQ2W1104 (P055)
Batteries	CR1620 3V	CR1620 3V

**FINE TUNING PARALLAX ADJUSTMENT**

An excellent tool to help easily adjust and fine tune parallax adjustment to reach the optimal setting. Small, medium, and large wheels provide users more choices according to their preference. Compatible with all Leapers UTG® scopes with Side Wheel Adjustable Parallax Turret.



Quick Reference AO Numbers

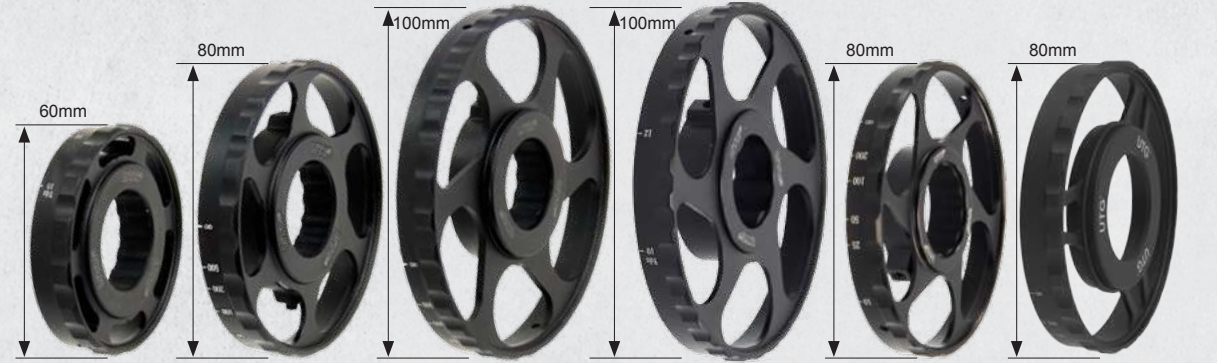

- SCP-SW060B**  
60mm Side Wheel Add-on
- SCP-SW080B**  
80mm Side Wheel Add-on
- SCP-SW100B**  
100mm Side Wheel Add-on
- SCP-SW100BL**  
100mm Side Wheel Add-on for **Bubble Leveler Scope**
- SCP-SW080BB**  
80mm Side Wheel Add-on for **Bugbuster® Scopes with SWAT**
- OP-SW080**  
80mm Side Wheel Add-on for **OP3 Series Scopes**

**RG-MF30GS**

Flip-to-side 30mm Ring with QD Lever Lock MIL-STD-1913 Picatinny Mount. Fits Magnifiers with 30mm, 27mm or 25.4mm(1") Tube.

**2 Inserts Included:**  
Mounting Diameter: 30mm, 27mm, or 25.4mm(1")

US PAT. D672,839  
US PAT. 8,397,421  
EU PAT. 001984576-0001

**LENS GLARE PROTECTION**

Reduces incoming glare and improves your sight picture on sunny days. Easy to install. Just screw onto the objective tube of the scope.



- SHD-H2440**  
2.4" Sunshade for 40MM Objective UTG® Scopes. Compatible with: SCP-U4164AOIEW, SCP-U4164AOIED, SCP-U312AOIEW, SCP-U394AOIEW, SCP-U394AOIED
- SCP-ES403**  
Eye shade for proper eye relief and glare prevention. Adaptor kit includes 3 shim rings in different thicknesses.







## INTRODUCTION

A precision rifle is only as good as the sum of its parts. Avid shooters take the time to better themselves on a regular basis; familiarizing themselves with their firearms, working on their breathing, trigger control, clearing malfunctions, and more. If we as shooters dedicate so much time and effort out on the range, repetition after repetition. As a manufacturer, we understand the importance of dedicating our full attention, time, and effort into the products we make available to you. Take for example, the importance of a high quality pair of scope rings. Long distance precision requires a synchronized sum of parts up range first before performing down range at distance. The relationship between the optic, scope rings, and the firearm's receiver requires much attention and precise execution to work well together and ultimately for the shooter. It is this specific parts relationship that we hone in on during the manufacturing of our scope rings and along with that, the same attention to detail and precise execution every step of the way.

**LEAPERS, INC.**  
**THE BEST NEVER REST**  
**LIFETIME WARRANTY**

## ABSOLUTE COMMITMENT TO QUALITY

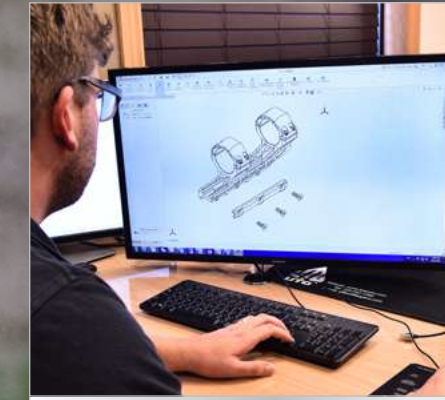

Intensive Engineering and Programming



State of the Art Manufacturing



Optimized Fixture Design and Layout



Total Commitment to Precision



Relentless Search for Excellence



Best Valued Products on the Market

## MUST HAVE PRODUCTS FOR 2019



ACCU-SYNC® SCOPE RINGS



P.O.I.® SCOPE RINGS



PRECISION STEEL RINGS

**UTG RING MOUNTS**  
 FOR OPTICS/FLASHLIGHTS/LASERS



# ACCU-SYNC® OFFSET PICATINNY SCOPE RINGS

- 6061-T6 ALUMINUM
- CNC MACHINED
- MIL-STD-1913 PICATINNY
- OFFSET
- SUPER SLIM PROFILE
- AVAILABLE COLOR(S)
  - Matte Black Anodized
  - Matte Blue Anodized
  - Matte Red Anodized
  - FDE Cerakote®
  - OD Green Cerakote®
  - Gun Metal Cerakote®
- DIMENSIONS



## ACCU-SYNC® Offset Picatinny Scope Rings

- Precision CNC Machined Aircraft Aluminum in a Variety of Different Colored Anodizations and Cerakote®
- Radiused Edges and Corners to Prevent Snagging of Other Gear



SINGLE OFFSET RINGS



Radiused Edges and Corners

Significant Lightening Cuts Massively Reduce Weight Without Compromising Durability



INTEGRAL OFFSET RINGS



Super Slim Design with Lightening Cuts Reduce Weight without Compromising Structural Integrity

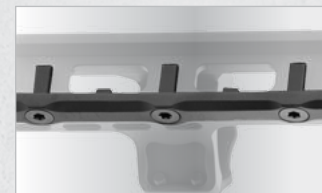

Locking Side Plate with Torx Screws and Square-shaped Integral Recoil Stops for a Secure and Repeatable Zero Hold



Precision Machined Inner Ring Surface to Achieve a Seamless Interface Between the Scope Ring and Tube



## Additional Color Anodized Accessories Available



Ultra Slim M-LOK® | Keymod Handstops [Also Refer to P. 149]



UTG PRO® AR15 2-Tone Super Slim Free Float M-LOK® | Keymod Rail Systems [Also Refer to P. 072]



UTG PRO® AR15 Mil-Spec 6 Position Receiver Extension Tubes [Also Refer to P. 138]



MEDIUM PROFILE



HIGH PROFILE

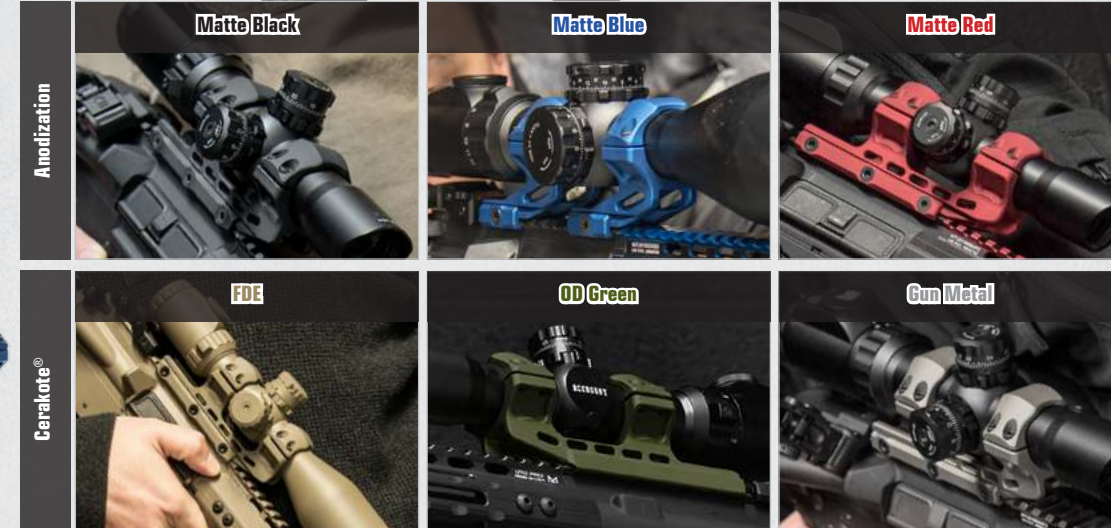

Anodization

Cerakote®

Model #	Matte Black	AIR11834	AIR11850	AIR12234	AIR12250	AIR31834	AIR31850	AIR32234	AIR32250	AIR42250	AIR122S	AIR322S	AIR422S
Ring Type	Integral Offset Rings (set of 11)										Single Offset Rings (set of 21)		
Ring Diameter	1"	1"	1"	1"	30mm	30mm	30mm	30mm	30mm	34mm	1"	30mm	34mm
Profile	Medium	Medium	High	High	Medium	Medium	High	High	High	High	High	High	High
Max. Scope Outer Dia.	61mm	61mm	69mm	69mm	65mm	65mm	73mm	73mm	77mm	69mm	73mm	77mm	77mm
A-Center Height	31mm	31mm	35mm	35mm	33mm	33mm	37mm	37mm	39mm	35mm	37mm	39mm	39mm
B-Saddle Height	18mm	18mm	22mm	22mm	18mm	18mm	22mm	22mm	22mm	22mm	22mm	22mm	22mm
C-Ring Width	25mm	25mm	25mm	25mm	25mm	25mm	25mm	25mm	25mm	25mm	25mm	25mm	25mm
D-Ring Distance	44mm	60mm	44mm	60mm	44mm	60mm	44mm	60mm	60mm	60mm	N/A	N/A	N/A
E-Integral Base Length	100mm	100mm	100mm	100mm	100mm	100mm	100mm	100mm	100mm	100mm	32mm	32mm	32mm
F-Offset Distance	34mm	50mm	34mm	50mm	34mm	50mm	34mm	50mm	50mm	50mm	37mm	37mm	37mm
Other Available Colors #													
	AIR11834AB	AIR11850AB	AIR12234AB	AIR12250AB	AIR31834AB	AIR31850AB	AIR32234AB	AIR32250AB	AIR42250AB	AIR122SAB	AIR322SAB	AIR422SAB	AIR422SAB
	AIR11834AR	AIR11850AR	AIR12234AR	AIR12250AR	AIR31834AR	AIR31850AR	AIR32234AR	AIR32250AR	AIR42250AR	AIR122SAR	AIR322SAR	AIR422SAR	AIR422SAR
	AIR11834M	AIR11850M	AIR12234M	AIR12250M	AIR31834M	AIR31850M	AIR32234M	AIR32250M	AIR42250M				
	AIR11834D	AIR11850D	AIR12234D	AIR12250D	AIR31834D	AIR31850D	AIR32234D	AIR32250D	AIR42250D				
	AIR11834G	AIR11850G	AIR12234G	AIR12250G	AIR31834G	AIR31850G	AIR32234G	AIR32250G	AIR42250G				



# P.O.I.® PICATINNY | DOVETAIL SCOPE RINGS

- MADE IN USA
- 6061-T6 ALUMINUM & STEEL
- PRECISION MACHINED
- MIL-STD-1913 PICATINNY
- 9MM-11MM DOVETAIL
- US PAT. D771218
- EU PAT. 002761064-0001
- SUPER SLIM PROFILE
- AVAILABLE COLOR(S)
  - Matte Black Anodized
- DIMENSIONS



## UTG PRO® Precision Optics Interface - P.O.I.® Scope Rings

- The Michigan Difference - Enhanced Precision, Material Strength, and Quality Control
- Snag Free Contoured Profile with Reduced Weight and Size
- Interfaces with Scope Tube and Firearm Mounting Base at All Key Points
- Secure and Reliable Interface Possible Between Optic and Firearm



## PRECISION OPTICS INTERFACE (P.O.I.®)

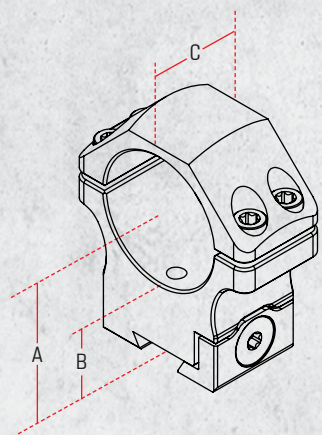

PICATINNY



DOVETAIL

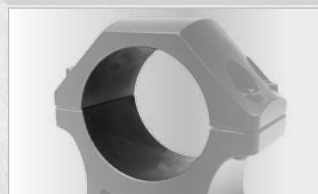

Precision Machined Inner Ring Interfaces with Scope Tube to Achieve a Seamless Ring-to-Scope Interaction

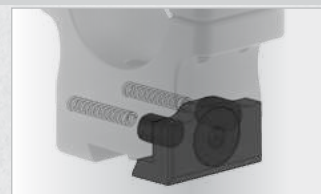

Steel Locking Side Plate Controlled by Dual Spring Loaded Guide Rods with Torx Screw Locking Ensures a Secure and Repeatable Zero Hold



Snag Free Contoured Profile with Reduced Weight and Size



.50 BMG RATED



PICATINNY

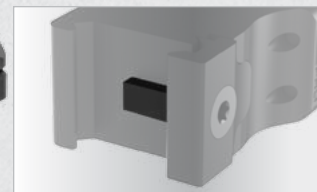

Square-shaped Integral Recoil Stop with Complete Surface Contact Eliminates the Possibility of Forward and Rearward Movement from Recoil



DOVETAIL

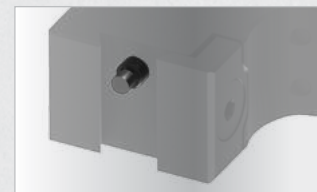

Removable Threaded Recoil Stop Eliminates the Possibility of Forward and Rearward Recoil that Occurs with Spring Air Rifles



LOW PROFILE



MEDIUM PROFILE



HIGH PROFILE

Model #	RWU012510	RWU012515	RWU012520	RWU013010	RWU013015	RWU013022	RWU013415	RWU013420	RDU012515	RDU012520	RDU013010	RDU013015	RDU013022
Ring Type	Picatinny [set of 2]								Dovetail [set of 2]				
Ring Diameter	1"	1"	1"	30mm	30mm	30mm	34mm	34mm	1"	1"	30mm	30mm	30mm
Profile	Low	Medium	High	Low	Medium	High	Medium	High	Medium	High	Low	Medium	High
Max. Scope Outer Dia.	45mm	55mm	65mm	49mm	59mm	73mm	63mm	73mm	55mm	65mm	49mm	59mm	73mm
A-Center Height	23mm	28mm	33mm	25mm	30mm	37mm	32mm	37mm	28mm	33mm	25mm	30mm	37mm
B-Saddle Height	10mm	15mm	20mm	10mm	15mm	22mm	15mm	20mm	15mm	20mm	10mm	15mm	22mm
C-Ring Width	22mm	22mm	22mm	22mm	22mm	22mm	22mm	22mm	22mm	22mm	22mm	22mm	22mm



# MAX STRENGTH™ QUICK DETACH PICATINNY SCOPE RINGS

- AIRCRAFT ALUMINUM
- PRECISION MACHINED
- MIL-STD-1913 PICATINNY
- QD LEVER LOCK
- QD TWIST LOCK
- US PAT. 8397421
- US PAT. D638089
- AVAILABLE COLOR(S)
- Matte Black Anodized
- DIMENSIONS



## MAX STRENGTH™ QD Lever Lock | QD Twist Lock Scope Rings

- Posi-lock Crossbolt and Spring Tension Controlled Locking Plate with Steel Insert Guarantees a Secure Installation and Repeatable Zero
- Lightening Cuts Reduce Overall Weight (Medium and High Profile Models Only)



QD LEVER LOCK



QD TWIST LOCK



Protective Synthetic Grip Tape Applied on Ring's Internal Surface to Secure Slightly Undersized Scope Tubes



Posi-lock Crossbolt with Anti-rotation Tab for Optimum Fit and Zero Retention



Lightening Cuts Reduce Overall Weight Without Compromising Structural Integrity or Performance



QD LEVER LOCK



Quick Detach Lever Lock with Tension Adjustment Screw for a Fine Tuned Installation



QD TWIST LOCK

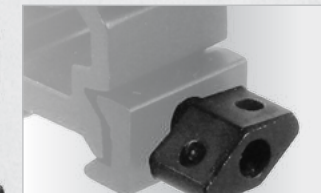

Twist Lock for an Easy Installation with Allen Holes to Apply Recommended Torque



LOW PROFILE



MEDIUM PROFILE

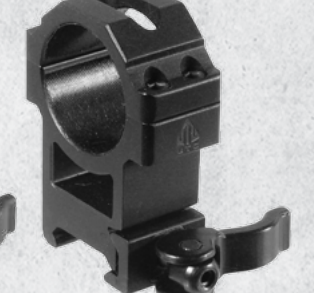

HIGH PROFILE

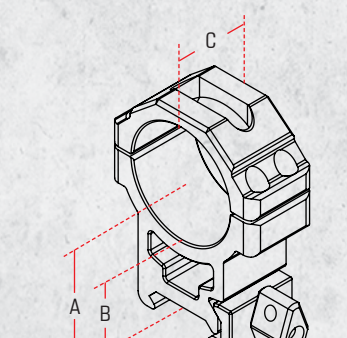
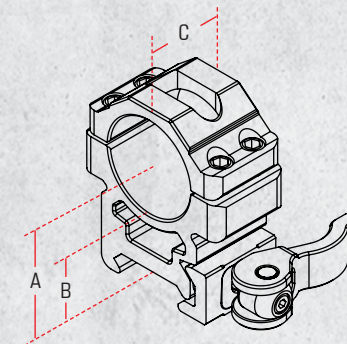

Model #	RQ2W1104	RQ2W1154	RQ2W1204	RQ2W3104	RQ2W3154	RQ2W3224	RG2W1104	RG2W1154	RG2W1204	RG2W3104	RG2W3154	RG2W3224
Ring Type	QD Lever Lock Picatinny [set of 2]						QD Twist Lock Picatinny [set of 2]					
Ring Diameter	1"	1"	1"	30mm	30mm	30mm	1"	1"	1"	30mm	30mm	30mm
Profile	Low	Medium	High	Low	Medium	High	Low	Medium	High	Low	Medium	High
Max. Scope Outer Dia.	45mm	55mm	65mm	49mm	59mm	73mm	45mm	55mm	65mm	49mm	59mm	73mm
A-Center Height	23mm	28mm	33mm	25mm	30mm	37mm	23mm	28mm	33mm	25mm	30mm	37mm
B-Saddle Height	10mm	15mm	20mm	10mm	15mm	22mm	10mm	15mm	20mm	10mm	15mm	22mm
C-Ring Width	18mm	22mm	22mm	22mm	22mm	22mm	18mm	22mm	22mm	22mm	22mm	22mm



# ACCUSHOT® PICATINNY | DOVETAIL SCOPE RINGS

- AIRCRAFT ALUMINUM
- PRECISION MACHINED
- MIL-STD-1913 PICATINNY
- DOVETAIL
- AVAILABLE COLOR(S)  
■ Matte Black Anodized
- DIMENSIONS



## ACCUSHOT® Picatinny | Dovetail Scope Rings

- Protective Synthetic Grip Tape Applied on Ring's Internal Surface to Secure Scope Tube
- Lightening Cuts Reduce Overall Weight



PICATINNY



DOVETAIL



Protective Synthetic Grip Tape Applied on Ring's Internal Surface to Secure Scope Tube



Hex Thumb Nut Lock for an Easy Installation with Allen Holes to Apply Additional Torque for Added Security (Picatinny Models)



Dual Locking Hex Screws for a Secure Installation (Dovetail Models)



LOW PROFILE    MEDIUM PROFILE    HIGH PROFILE    INTEGRAL RING    INTEGRAL OFFSET RING

Model #	RGWM-25L2	RGWM-25M4	RGWM-25H4	RGWM-30L4	RGWM-30M4	RGWM-30H4	RGWM2PA-25M4	RGWM2PA-25H4
Ring Type	Picatinny Single Rings [set of 2]						Picatinny Integral Rings [set of 1]	
Ring Diameter	1"	1"	1"	30mm	30mm	30mm	1"	1"
Profile	Low	Medium	High	Low	Medium	High	Medium	High
Max. Scope Outer Dia.	45mm	53mm	61mm	47mm	57mm	73mm	61mm	61mm
A-Center Height	23mm	27mm	31mm	24mm	29mm	37mm	31mm	31mm
B-Saddle Height	10mm	14mm	18mm	9mm	14mm	22mm	18mm	18mm
C-Ring Width	16mm	21mm	21mm	21mm	21mm	21mm	21mm	18mm
D-Ring Distance	N/A	N/A	N/A	N/A	N/A	N/A	58mm	39mm
E-Integral Base Length	N/A	N/A	N/A	N/A	N/A	N/A	100mm	62mm
Offset Distance	N/A	N/A	N/A	N/A	N/A	N/A	N/A	38mm



Recoil Stop Crossbolt for Optimum Fit and Zero Retention (Picatinny Models)



Threaded Recoil Stop Pin for Optimum Fit and Added Zero Retention (Dovetail Models)

Model #	RGPM-25M4	RGPM-25H4	RGPM-30M4	RGPM-30H4	RGPM2PA-25M4	RGPM2PA-25H4	RGPM2PA-25H4	RGPM2PA-30M4	RGPM2PA-30H4
Ring Type	Dovetail Single Rings [set of 2]				Dovetail Integral Rings [set of 1]				
Ring Diameter	1"	1"	30mm	30mm	1"	1"	1"	30mm	30mm
Profile	Medium	High	Medium	High	Medium	High	High	Medium	High
Max. Scope Outer Dia.	53mm	67mm	57mm	71mm	53mm	67mm	67mm	57mm	71mm
A-Center Height	27mm	34mm	29mm	36mm	27mm	34mm	34mm	29mm	36mm
B-Saddle Height	14mm	21mm	14mm	21mm	14mm	21mm	21mm	14mm	21mm
C-Ring Width	21mm	21mm	21mm	21mm	21mm	21mm	21mm	21mm	21mm
D-Ring Distance	N/A	N/A	N/A	N/A	58mm	58mm	39mm	58mm	58mm
E-Integral Base Length	N/A	N/A	N/A	N/A	100mm	100mm	62mm	100mm	100mm
Offset Distance	N/A	N/A	N/A	N/A	N/A	N/A	38mm	N/A	N/A



# PRECISION STEEL PICATINNY RINGS



# OFFSET | FTS RING MOUNTS & DOVETAIL-TO-PICATINNY ADAPTOR

- STEEL
- PRECISION MACHINED
- MIL-STD-1913 PICATINNY
- SUPER SLIM PROFILE
- AVAILABLE COLOR(S)
  - Matte Black Nitrided
- DIMENSIONS

## PRECISION STEEL RINGS

### Precision Steel Picatinny Rings

- Precision Machined from One Solid Block of Steel to Strict Tolerances for Optimal Fit
- Heat Treated QPQ Matte Black Nitrided for Strength and Additional Weather and Wear Resistance
- Progressively Machined for a Precise Inner Ring Diameter to Achieve Optimal Tube Alignment
- Radiused Edges and Corners to Prevent Snagging, Scratching, or Tearing of Other Gear and for Effortless Access to Scope Windage and Elevation Turrets



Flush-fitting Locking Side Plate Ensures a Secure and Repeatable Zero Hold

Square-shaped Recoil Stop Fully Engages Rail

Grooved Inner Surface Guarantees Tube Retention

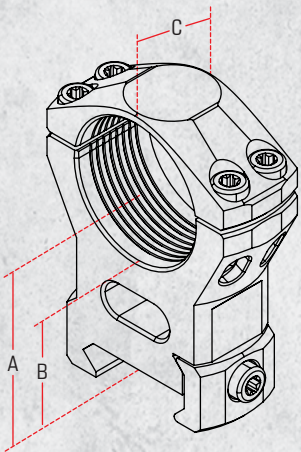

LOW PROFILE      MEDIUM PROFILE      HIGH PROFILE

Model #	RSW1104	RSW1154	RSW1204	RSW3104	RSW3154	RSW3224	RSW4154	RSW4204
Ring Type	Picatinny Single Rings [set of 2]							
Ring Diameter	1"	1"	1"	30mm	30mm	30mm	34mm	34mm
Profile	Low	Medium	High	Low	Medium	High	Medium	High
Fits Scope Outer Obj. Up to	45mm	55mm	65mm	49mm	59mm	73mm	63mm	73mm
A-Center Height	23mm	28mm	33mm	25mm	30mm	37mm	33mm	37mm
B-Saddle Height	10mm	15mm	20mm	10mm	15mm	22mm	20mm	20mm
C-Ring Width	16mm	16mm	16mm	16mm	16mm	16mm	16mm	16mm

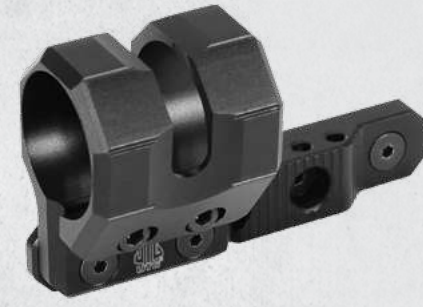

### Offset Flashlight Ring Mounts

- Mounts directly to Keymod or M-LOK® Interface (Depending on Model) for Optimal Close to Bore Alignment
- Snag-free Low Profile Design
- Removable Offset Mount Provides 1.60" Forward or Rearward Offset in addition to the Flashlight Ring's 1.12" Vertical or Downward Offset
- Complete with 2 Inserts to Accept 27mm, 25.4mm (1"), or 20mm Flashlight Tube Diameters [Also Refer to P.129]

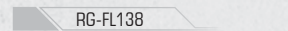

### Angled Offset Ring Mount

- Offset Angle for Optimal Close to Bore Alignment
- Twist-lock Mount to Fit on any Picatinny Rail
- Lightweight, Precision Machined Aluminum with a Matte Black Finish
- Complete with 2 Inserts to Accept 27mm, 25.4mm (1"), or 20mm Flashlight Tube Diameters [Also Refer to P.129]



US PAT. D672839    US PAT. 8397421



### Flip-To-Side Magnifier Ring Mount

- Precision Machined From Aircraft Aluminum with a Matte Black Finish
- Quick Detach Lever Lock Fully Adjusts to Fit on Any Picatinny Rail
- Complete with 2 Inserts to Accept 30mm, 27mm, or 25.4mm (1") Tube Diameters [Also Refer to P.045]

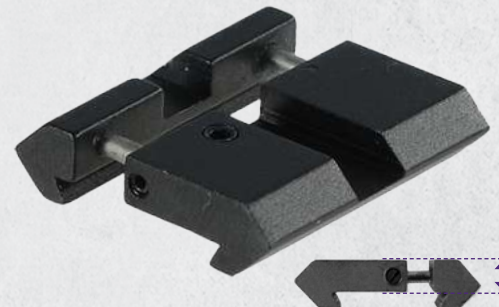

### Dovetail-To-Picatinny Snap-in Rail Adaptor

- Allows Most Picatinny Products to Fit Dovetail Rails
- Spring Tensioned Design Snaps Adaptor into Picatinny/Weaver Base
- Features Removable Stop Pin for Added Retention
- 2 Adaptors Per Pack, Matte Black

US PAT. 8752325



## INTRODUCTION

Just like all of our other categories of products, Leapers UTG® continuously strives to provide a comprehensive selection of firearm specific mounting systems and modular system accessories. Trust in us to continue to listen to our customer's suggestions and feedback and devote our full energy, attention, and effort to developing what is asked of us from you, our loyal customers. We do not just offer parts and tools; every item incorporates the UTG® touch. Designed, developed, prototyped, and executed entirely in-house. If you find yourself here looking to modularly update and kit out your MSR from the ground up, you need not look any further. Our full lineup of products are always ready out of the box and come complete with everything you need to get up and gunning. New for 2019, Leapers UTG® and UTG PRO® is excited to debut and introduce our Made in USA Micro Gas Block, MR556, G3, RPR, and Ultra Slim handguards, and a whole new series of optic dedicated mounts.

**LEAPERS, INC.**  
**THE BEST NEVER REST**  
**LIFETIME WARRANTY**

## ABSOLUTE COMMITMENT TO QUALITY

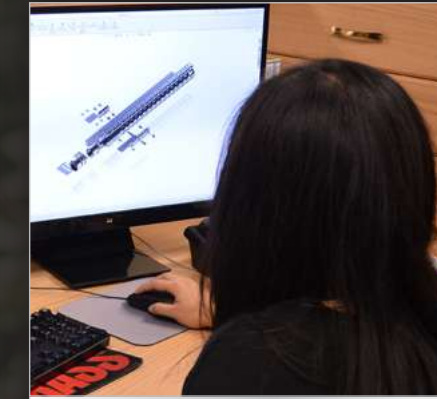

Intensive Engineering and Programming



State of the Art Manufacturing



Optimized Fixture Design and Layout



Total Commitment to Precision



Relentless Search for Excellence



Best Valued Products on the Market

### NEW AND MUST HAVE PRODUCTS FOR 2019

MR556 | G3 HANDGUARDS



RUGER® RPR HANDGUARDS

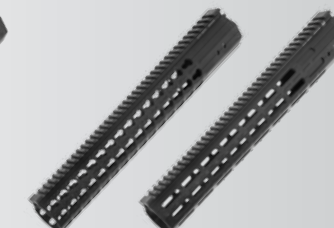

AR15 ULTRA SLIM HANDGUARDS



RDM20 | RMR® | MRO® | T1 MOUNTS



MICRO GAS BLOCKS



# MOUNTING SYSTEMS

COMPLETE SOLUTIONS - HANDGUARDS, MOUNTS, & ACCESSORIES



	MR556   G3   RPR® HANDGUARDS	AR15 HANDGUARDS	AR308 HANDGUARDS	RDM20   RMR®   MRO®   T1   UNIVERSAL RISERS	MICRO GAS BLOCKS	CARRY HANDLE   BARREL   HANDGUARD RAIL MOUNTS	AK HANDGUARDS & MOUNTS	SKS   MOSIN MOUNTS	SHOTGUN MOUNTS	M14   M1   10/22   BOLT ACTION MOUNTS	MP5   G3   G36 MOUNTS	ANGLE & BARREL MOUNTS	AIR RIFLE MOUNTS
<b>PAGE RANGE</b>	<b>P.064 - P.065</b> MR556 Super Slim Free Float M-LOK® Rail .....064 MR556 Super Slim Free Float Keymod Rail .....064 G3 Super Slim M-LOK® Rail .....064 Ruger RPR® Super Slim Free Float M-LOK® Rail .....065 Ruger RPR® Super Slim Free Float Keymod Rails .....065	<b>P.066 - P.077</b> Ultra Slim Free Float M-LOK® Rails .....066-067 Super Slim Free Float M-LOK® Rails .....068-069 Super Slim Free Float Keymod Rails .....070-071 Super Slim Free Float 2-Tone Rails .....072 Super Slim Free Float Rails .....073 Super Slim Drop-in M-LOK® Rails .....074-075 Super Slim Drop-in Keymod Rails .....074-075 Super Slim Drop-in Rails .....074-075 Drop-in Quad Rails .....076-077	<b>P.078 - P.083</b> Super Slim Free Float M-LOK® Rails .....078-079 Super Slim Free Float Keymod Rails .....080-081 Super Slim Free Float Rails .....082 Drop-in Quad Rail .....083	<b>P.084 - P.087</b> RDM20 Super Slim Risers .....084 RMR® Super Slim Risers .....085 MRO Super Slim Risers .....085 T1 Super Slim Risers .....085 Universal Super Slim Risers .....086 20MOA Compensator Riser .....086 Classic Universal Risers .....087	<b>P.088</b> Adjustable Gas Block .....088 Micro Gas Block .....088	<b>P.089</b> Carry Handle Rail Mount .....089 Tri-rail Barrel Mount .....089 Picatinny Rails .....089	<b>P.090 - P.093</b> Super Slim Keymod Rails .....090-091 Quad Rails .....092 Quick Detach Side Mount .....093 Steel Side Plate .....093 QD Low Profile Top Rail .....093	<b>P.094</b> SKS Receiver Cover with Integrated Picatinny Rail and Shell Deflector .....094 SKS Shell Deflector .....094 Mosin Nagant Tri-rail Mount .....094	<b>P.095</b> Mossberg 500 Receiver Top Rail .....095 Remington 870 Receiver Top Rail .....095 Remington 870 Saddle Mount Receiver Top Rail .....095 Saiga 12 Quad Rail .....095	<b>P.096</b> M14 M1 Scope Mount .....096 M1 Carbine Scope Mount .....096 10/22 Scout Rail .....096 10/22 Low Profile Scope Mount .....096 Remington 700 Long Action Scope Mounts .....096 Remington 700 Short Action Scope Mounts .....096	<b>P.097</b> MP5 G3 Low Profile Claw Mount .....097 MP5 G3 Steel Clow Mount with Stanag Dimension .....097 G36 Carry Handle Scope .....097 G36 Handguard Picatinny Rails .....097	<b>P.098</b> Rifle Barrel Mounts .....098 Shotgun Barrel Mounts .....098	<b>P.099</b> Low Profile Dovetail to Picatinny Rail Adaptor .....099 Compensation Mount for RWS Diana Airgun with T06 Trigger .....099 Dovetail to Picatinny/Weaver Adaptor Mount .....099
<b>HIGHLIGHTS</b>	New products include the Super Slim Free Float Handguard available in both M-LOK® and Keymod modular systems for the HK MR556 and Ruger RPR® Bolt Action rifle featuring the same lightweight characteristics and feature set made known by the UTG PRO® USA Made Super Slim lineup of AR15 handguards. Making its return and new for 2019, is our revamped HK91/G3 handguard, an M-LOK® Super Slim handguard that uses a simple drop-in installation	Take a look at our extensive lineup of Super Slim handguards for the AR15 MSR. With multiple lengths, finishes, drop-in and free float system options, and models available in both M-LOK® and Keymod, we have a solution to tailor to any shooter's particular requirements. Check out our UTG PRO® USA Made Ultra Slim handguard featuring the most in weight reduction features to include a Titanium precision barrel nut and weight reducing lightening cuts made throughout the handguard	Super Slim Handguards available in both M-LOK® and Keymod featuring the same design implementations and feature sets as their AR15 MSR counterparts. New to 2019 are models available for the DPMS Gen. 2	A plethora of both dedicated and universal mounts and risers for installation on MIL-STD-1913 Picatinny equipped rifles or rear sight dovetails of pistols. Multiple heights available to include heights for absolute co-witness, lower 1/3 co-witness, low profile, and more	.750" Fixed and adjustable micro gas blocks to go with all of our UTG PRO® USA Made Super Slim and Ultra Slim Free Float handguard systems	Keeping the classics in mind, some times less is more. For those who appreciate the minimalist approach in regards to AR15 builds, our selection of standard handguard mounts and carry handle rear sights and accessories will make you feel right at home all from a one stop shopping experience	Continuing our lineage of AK handguards, mounts, and accessories, make sure you stop and see our series of Super Slim Keymod Drop-in handguards. Available in three different lengths for a variety of different AK platform variants, the lightweight, sleek, and modular Super Slim puts personalization in mind without the added bulk and weight	In order to satisfy our need to be your one stop shopping solution. We make it a very important note to keep stock of classic mounts not easily found in today's markets. Customers will continue to enjoy from us mounts and accessories made for the venerable SKS and Mosin Nagant	Still very much prevalent in the shooting community, Saiga 12s and more traditional shotguns are still considered a staple with us. Continue to enjoy a variety of different optic mounts and handguards for these staples.	Here you will find a garden variety of different mounts and accessories for the aforementioned platforms. Several different solutions are available to quickly and easily mount optics and accessories without the need for permanent modification or a gunsmith.	Enjoy various scope and accessory mounting options for these classics here. Simple, affordable, and quality solutions for these fan favorites.	Universal MIL-STD-1913 Picatinny mounts ideally used for adding accessories onto firearms that lack mountable handguards, flat tops, etc. Universal Barrel mounts offer quick solutions for adding a bipod or flashlight to traditional firearms not equipped with MIL-STD-1913 Picatinny rails.	We enjoy plinking just as much as the rest of you and value the importance of getting an optic set up just right on an airgun. Look out for our barrel droop compensating mounts, dovetail to MIL-STD-1913 adaptors, and our universal scope mount for round or straight dovetail airgun receivers here.
<b>APPLICATIONS</b>	<ul style="list-style-type: none"> <li>• HK MR556</li> <li>• HK91/G3 and Clones</li> <li>• Ruger Precision Rifle®</li> </ul>	<ul style="list-style-type: none"> <li>• Direct Impingement AR Platform</li> </ul>	<ul style="list-style-type: none"> <li>• S&amp;W M&amp;P10</li> <li>• DPMS LR-308 and Gen. 2</li> <li>• Armalite AR-10</li> <li>• Clones</li> </ul>	<ul style="list-style-type: none"> <li>• Modern Sporting Rifles</li> <li>• Pistols</li> <li>• Shotguns</li> <li>• AR Pistols</li> <li>• Pistol Caliber Carbines</li> </ul>	<ul style="list-style-type: none"> <li>• Direct Impingement AR Platform</li> </ul>	<ul style="list-style-type: none"> <li>• Fixed A2 Sight and Carry Handle Equipped AR15 and or Stock Configuration Restricted AR15</li> </ul>	<ul style="list-style-type: none"> <li>• USA Made AK and Clones</li> <li>• Romanian/Chinese Made AK and Clones</li> <li>• Yugoslavian Made AK and Clones</li> <li>• Hungarian Made AMD-65 and Clones</li> </ul>	<ul style="list-style-type: none"> <li>• SKS Rifle and Clones</li> <li>• Mosin Nagant Rifles</li> </ul>	<ul style="list-style-type: none"> <li>• Saiga 12 Semi-Auto Shotgun</li> <li>• Mossberg 500 Pump Action Shotgun</li> <li>• Remington 870 Pump Action Shotgun</li> </ul>	<ul style="list-style-type: none"> <li>• M1 Carbine</li> <li>• M1A &amp; M14 Rifles</li> <li>• 10/22® Rifles</li> <li>• Remington 700 Rifles</li> </ul>	<ul style="list-style-type: none"> <li>• MP5 and Clones</li> <li>• G3 Rifles and Clones</li> <li>• G36 Rifles and Clones</li> </ul>	<ul style="list-style-type: none"> <li>• Firearms with MIL-STD-1913 Picatinny</li> <li>• Firearms without MIL-STD-1913 Picatinny</li> </ul>	<ul style="list-style-type: none"> <li>• Airguns with 9mm-11mm Dovetail Rails</li> </ul>
<b>SUGGESTED USES</b>	<ul style="list-style-type: none"> <li>• Sport Shooting &amp; Competition</li> <li>• Long Range Precision</li> <li>• Defense Agencies</li> <li>• Custom Builds</li> <li>• Home and Personal Defense</li> <li>• Recreational</li> </ul>	<ul style="list-style-type: none"> <li>• Sport Shooting &amp; Competition</li> <li>• Custom Builds</li> <li>• Home and Personal Defense</li> <li>• Recreational</li> </ul>	<ul style="list-style-type: none"> <li>• Sport Shooting &amp; Competition</li> <li>• Long Range Precision</li> <li>• Defense Agencies</li> <li>• Custom Builds</li> <li>• Recreational</li> </ul>	<ul style="list-style-type: none"> <li>• Sport Shooting &amp; Competition</li> <li>• Defense Agencies</li> <li>• Custom Builds</li> <li>• Home and Personal Defense</li> <li>• Recreational</li> <li>• Non-magnified Optics Installation</li> <li>• Optics-ready Pistols</li> </ul>	<ul style="list-style-type: none"> <li>• Custom and AR Projects Built from the Ground Up</li> </ul>	<ul style="list-style-type: none"> <li>• Defense Agencies</li> <li>• Custom Builds</li> <li>• Recreational</li> <li>• Home and Personal Defense</li> <li>• Law Enforcement Agencies</li> </ul>	<ul style="list-style-type: none"> <li>• Defense Agencies</li> <li>• Custom Builds</li> <li>• Recreational</li> <li>• Home and Personal Defense</li> </ul>	<ul style="list-style-type: none"> <li>• Long Range Precision</li> <li>• Custom Builds</li> <li>• Recreational</li> <li>• Hunting</li> <li>• 922R Compliance</li> </ul>	<ul style="list-style-type: none"> <li>• Custom Builds</li> <li>• Recreational</li> <li>• Home and Personal Defense</li> <li>• Law Enforcement Agencies</li> <li>• Hunting</li> <li>• 922R Compliance</li> </ul>	<ul style="list-style-type: none"> <li>• Long Range Precision</li> <li>• Custom Builds</li> <li>• Recreational</li> <li>• Home and Personal Defense</li> <li>• Hunting</li> <li>• Plinking</li> </ul>	<ul style="list-style-type: none"> <li>• Custom Builds</li> <li>• Recreational</li> <li>• Home and Personal Defense</li> <li>• Law Enforcement Agencies</li> <li>• Defense Agencies</li> </ul>	<ul style="list-style-type: none"> <li>• Custom Builds</li> <li>• Recreational</li> <li>• Home and Personal Defense</li> <li>• Law Enforcement Agencies</li> <li>• Defense Agencies</li> </ul>	<ul style="list-style-type: none"> <li>• Barrel Droop Compensation</li> <li>• Installation of Dot Sight/Optics</li> <li>• Plinking</li> <li>• Sport Shooting &amp; Competition</li> <li>• Small Game Hunting</li> </ul>





# MR556 | G3 SUPER SLIM RAIL SYSTEMS

- MADE IN USA**
- 6061-T6 ALUMINUM
- PRECISION MACHINED
- AVAILABLE COLOR(S)  
■ Matte Black Anodized

- MR556 Models:**
- MIL-STD-1913 PICATINNY
  - FREE FLOAT
  - OCTAGONAL PROFILE
  - PARTS INCLUDED

- M-LOK® Model:  
8-Slot Picatinny Rail Section & QD Sling Swivel Adaptor
- Keymod Model:  
4-Slot & 8-Slot Picatinny Rail Sections

- Barrel Nut Adaptor
- Installation Hardware

- G3 Model:**
- PARTS INCLUDED

- M-LOK® 8-Slot Picatinny Rail Section & QD Sling Swivel Adaptor
- Installation Hardware

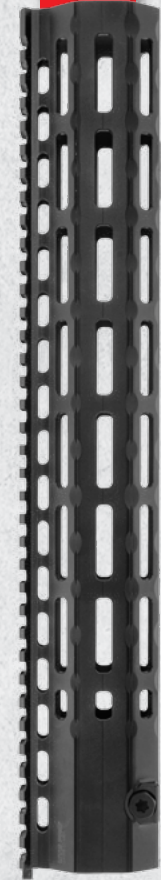

MR556 RAIL

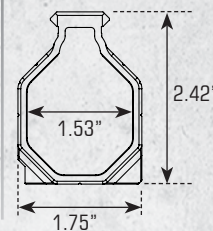

G3 RAIL

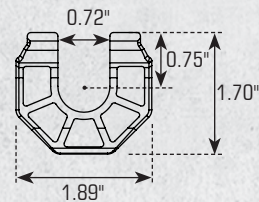

## UTG PRO® MR556 Super Slim Free Float Rail Systems

- Scalloped Top Picatinny Rail Edges for Easy and Snag Free Accessory Mounting
- Super Lightweight with 36 Slot Picatinny Top Rail, Flush Fitting, and Continuous with Flat Top Upper Receiver
- M-LOK®/Keymod Slots on 7 Tracks



## UTG PRO® G3 Super Slim Rail System

- Ergonomic Design with M-LOK® Slots on 5 Tracks
- One-piece Design Compatible with G3/HK91 Rifle and Clones



M-LOK® MTU039SSM  
KEYMOD MTU039SSK

M-LOK® MTU043SSM  
KEYMOD MTU043SSK

**MR556 15" Rail**      **G3 12" Rail**

Model #	MTU039SSM	MTU039SSK	MTU043SSM
Application	MR556	MR556	G3
Length	14.6"	14.6"	12.0"
M-LOK® / Keymod Slots	49 M-LOK®	105 Keymod	21 M-LOK®
Top Picatinny Slots	36	36	N/A
Net Weight	12.2 oz	12.1 oz	11.3 oz



# RUGER PRECISION RIFLE® SUPER SLIM FREE FLOAT RAIL SYSTEMS

- MADE IN USA**
- 6061-T6 ALUMINUM
- PRECISION MACHINED
- MIL-STD-1913 PICATINNY
- OCTAGONAL PROFILE
- FREE FLOAT
- US PAT. 8806792
- DIMENSION

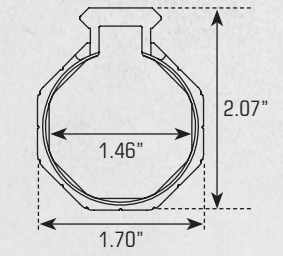

- AVAILABLE COLOR(S)  
■ Matte Black Anodized

- PARTS INCLUDED**

- M-LOK® Model:  
8-Slot Picatinny Rail Section & QD Sling Swivel Adaptor
- Keymod Model:  
4-Slot & 8-Slot Picatinny Rail Sections

- Barrel Nut, Locking Ring, and Barrel Nut Wrench
- Installation Hardware

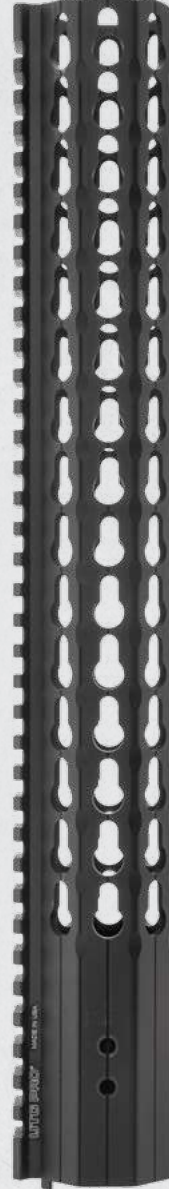

## UTG PRO® Ruger Precision Rifle® Super Slim Free Float Rail Systems

- M-LOK®/Keymod Slots on 7 Tracks
- Super Lightweight with 36 Slot Picatinny Top Rail, Flush Fitting, and Continuous with Receiver



Scalloped Top Picatinny Rail Edges for Snag Free Accessory Mounting

Ergonomic Finger Grooves for a Solid and Comfortable Grip

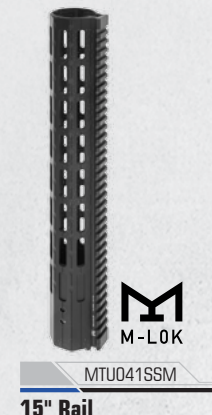

15" Rail

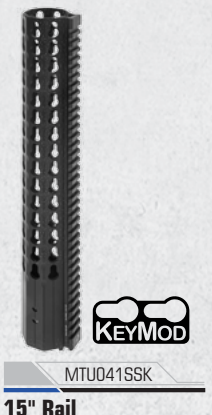

15" Rail



Flush Fitting and Continuous with Receiver



Integral Anti-rotation Tabs for Accurate Alignment with Receiver

Model #	MTU041SSM	MTU041SSK
Length	15.0"	15.0"
M-LOK® / Keymod Slots	49 M-LOK	105 Keymod
Top Picatinny Slots	36	36
Net Weight	19.1 oz	18.5 oz



# AR15 ULTRA SLIM FREE FLOAT M-LOK® RAIL SYSTEMS

- MADE IN USA**
- 6061-T6 ALUMINUM
- PRECISION MACHINED
- MIL-STD-1913 PICATINNY
- OCTAGONAL PROFILE
- FREE FLOAT
- US PAT. 8806792
- DIMENSION

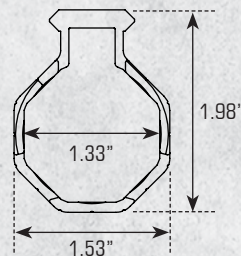

**AVAILABLE COLOR(S)**

■ Matte Black Anodized

**PARTS INCLUDED**

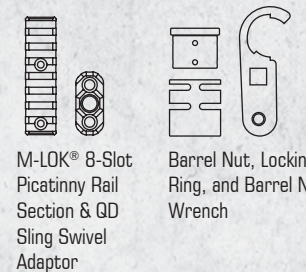

## UTG PRO® AR15 Ultra Slim Free Float M-LOK® Rail Systems

- Ultra Slim Design with Lightening Cuts Made Throughout the Handguard to Massively Reduce Weight, While Still Allowing for a High Level of Modularity
- Ergonomically Grooved Handguard Surface and Octagonal Profile Features Left and Right Side Grip Serrations
- Simple and User Friendly Installation



MTU019SSM3T Includes a Lightweight Titanium Barrel Nut (TLUBN01) 40% Lighter than Standard Steel Barrel Nut  
[Also Refer to P.067]



Lightening Cuts Reduce Weight

Knurled Texture at 3 and 9 O'clock Position

M-LOK® Slots on 3 Slot Tracks at the 3, 6 and 9 O'Clock Positions

Ergonomic Finger Grooves

Front and Rear End with M-LOK® Slots at the 1, 5, 7 and 9 O'Clock Positions



3-Slot Top Picatinny Rail Found at the Front and Rear of the Handguard



Compatible with Left or Right Handed Standard Mil-spec AR15 Upper Receivers



Integral Anti-rotation Tabs for Accurate Alignment with Upper Receiver



Flush Fitting and Continuous with Upper Receiver



## Additional Accessories Available



### UTG PRO® Super Slim Free Float Titanium Barrel Nut

- Precision Machined from Grade 5 Titanium
- Weight 1.8 oz, 40% Lighter than Standard Steel Barrel Nut
- Compatible with UTG PRO® USA Made AR15 Super Slim Free Float Handguards Only



## Additional M-LOK® Accessories Available



MT-AFGM01  
**M-LOK® Angled Foregrip**  
[Also Refer to P. 148]



TL-TRM01  
**M-LOK® Angled Index Mount**  
[Also Refer to P. 148]



MT-FGM01  
**M-LOK® Super Slim Aluminum Vertical Foregrip**  
[Also Refer to P. 150]



TL-HSM01  
**M-LOK® Ultra Slim Hand Stop**  
[Also Refer to P. 149]



RB-HP30MB (4/PACK)  
**Low Profile M-LOK® Rail Panel Covers**  
[Also Refer to P. 153]



TLUSW001  
TLUSW001D  
**UTG PRO® M-LOK® QD Sling Swivel Adaptor**  
[Also Refer to P. 156]



MTU019SSM3T  
**15" Rail Titanium Barrel Nut**

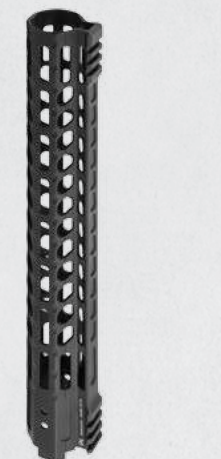

MTU019SSM3  
**15" Rail Steel Barrel Nut**

Model #	MTU019SSM3T	MTU019SSM3
Length	15.3"	15.3"
M-LOK® Slots	24	24
Top Picatinny Slots	6	6
Net Weight	10.0 oz	11.5 oz



# AR15 SUPER SLIM FREE FLOAT M-LOK® RAIL SYSTEMS

MOUNTING SYSTEMS

AR15 SUPER SLIM FREE FLOAT M-LOK® RAILS

- MADE IN USA
- 6061-T6 ALUMINUM
- PRECISION MACHINED
- MIL-STD-1913 PICATINNY
- OCTAGONAL PROFILE
- FREE FLOAT
- US PAT. 8806792
- DIMENSION

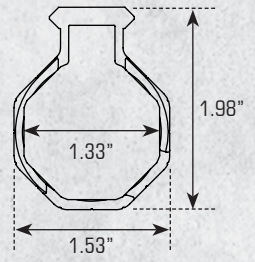

- AVAILABLE COLOR(S)
  - Matte Black Anodized
  - FDE Cerakote®
- PARTS INCLUDED

- M-LOK® 8-Slot Picatinny Rail Section & QD Sling Swivel Adaptor
- Barrel Nut, Locking Ring, and Barrel Nut Wrench
- Installation Hardware



## UTG PRO® AR15 Super Slim Free Float M-LOK® Rail Systems

- Ergonomic Octagonal Profile with Grooved Surface for a Solid and Comfortable Grip
- M-LOK® Slots on 7 Tracks

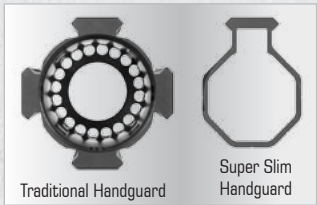
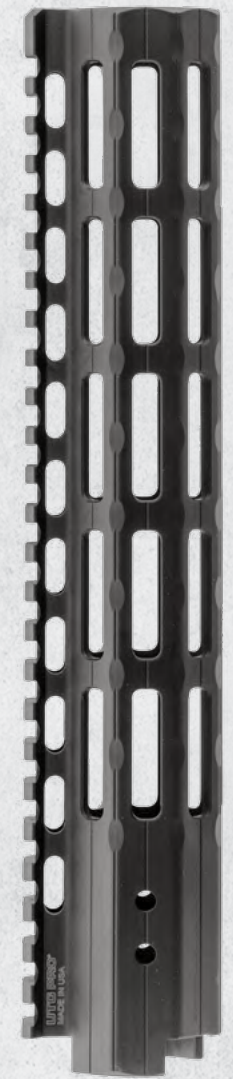

Traditional Handguard Super Slim Handguard  
Super Slim Design for Comfort and Weight Reduction



Flush Fitting and Continuous with Upper Receiver



Integral Anti-rotation Tabs for Accurate Alignment with Upper Receiver



### Additional M-LOK® Accessories Available



TL-HSM01  
M-LOK® Ultra Slim Hand Stop  
[Also Refer to P. 149]



TL-TRM01  
M-LOK® Angled Index Mount  
[Also Refer to P. 148]



RB-HP30MB (4/PACK)  
Low Profile M-LOK® Rail Panel Covers  
[Also Refer to P. 153]



MTU037SSM  
MTU037SSMD  
**17" Rail**

MTU019SSM  
MTU019SSMD  
**15" Rail**

MTU006SSM  
MTU006SSMD  
**13" Rail**

MTU025SSM  
**10" Rail**

MTU008SSM  
**5.5" Rail**

Model #	MTU037SSM	MTU019SSM	MTU006SSM	MTU025SSM	MTU008SSM
Length	17.3"	15.3"	12.9"	10.3"	5.5"
M-LOK® Slots	63	56	42	35	14
Top Picatinny Slots	42	37	31	25	13
Net Weight	13.8 oz	12.5 oz	11.2 oz	10.2 oz	7.3 oz

MOUNTING SYSTEMS

AR15 SUPER SLIM FREE FLOAT M-LOK® RAILS



# AR15 SUPER SLIM FREE FLOAT KEYMOD RAIL SYSTEMS

MOUNTING SYSTEMS

AR15 SUPER SLIM FREE FLOAT KEYMOD RAILS

- MADE IN USA
- 6061-T6 ALUMINUM
- PRECISION MACHINED
- MIL-STD-1913 PICATINNY
- OCTAGONAL PROFILE
- FREE FLOAT
- US PAT. 8806792
- DIMENSION

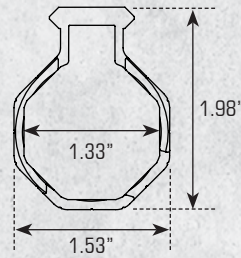

- AVAILABLE COLOR(S)**
- Matte Black Anodized
  - FDE Cerakote®
  - OD Green Cerakote®
  - Gun Metal Cerakote®
  - Burnt Bronze Cerakote®

**PARTS INCLUDED**

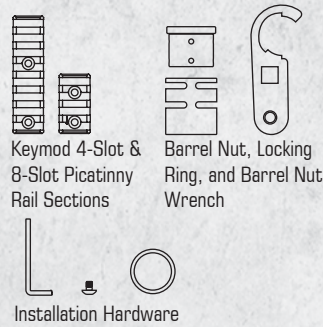

## UTG PRO® AR15 Super Slim Free Float Keymod Rail Systems

- Ergonomic Octagonal Profile with Grooved Surface for a Solid and Comfortable Grip
- Keymod Slots on 7 Tracks

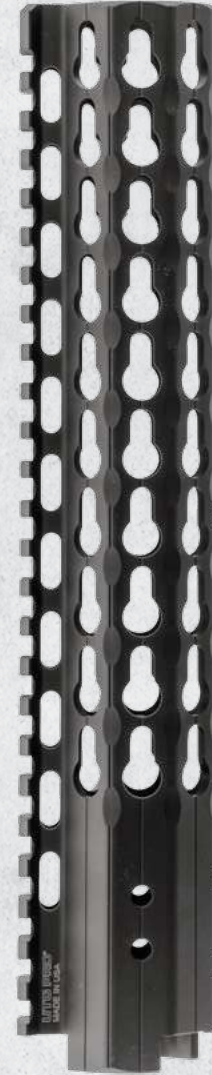

Scalloped Top Picatinny Rail Edges for Snag Free Accessories Mounting

Ergonomic Finger Grooves for a Solid and Comfortable Grip



Super Slim Design for Comfort and Weight Reduction



Flush Fitting and Continuous with Upper Receiver



Integral Anti-rotation Tabs for Accurate Alignment with Upper Receiver

MOUNTING SYSTEMS

AR15 SUPER SLIM FREE FLOAT KEYMOD RAILS



### Additional Keymod Accessories Available

- Keymod Angled Foregrip**  
[Also Refer to P. 148] (Model: MT-AFGK01)
- Keymod Angled Index Mount**  
[Also Refer to P. 148] (Model: TL-TRK01)
- Keymod Super Slim Aluminum Vertical Foregrip**  
[Also Refer to P. 150] (Model: MT-FGK01)



- MTU037SSK MTU037SSKD **17" Rail**
- MTU019SSK MTU019SSKG MTU019SSKM MTU019SSKZ **15" Rail**
- MTU006SSK **13" Rail**
- MTU025SSK **10" Rail**
- MTU004SSK **9" Rail**
- MTU005SSK **7" Rail**
- MTU008SSK **5.5" Rail**

Model #	MTU037SSK	MTU019SSK	MTU006SSK	MTU025SSK	MTU004SSK	MTU005SSK	MTU008SSK
Length	17.3"	15.3"	12.9"	10.3"	9.6"	7.2"	5.5"
Keymod Slots	126	112	91	70	63	42	28
Top Picatinny Slots	42	37	31	25	23	18	13
Net Weight	13.1 oz	11.9 oz	10.5 oz	9.7 oz	9.1 oz	8.1 oz	7.2 oz

# AR15 2-TONE SUPER SLIM FREE FLOAT M-LOK® | KEYMOD RAIL SYSTEMS

# AR15 SUPER SLIM FREE FLOAT RAIL SYSTEMS

MOUNTING SYSTEMS

AR15 2-TONE SUPER SLIM FREE FLOAT RAILS

- MADE IN USA**
- 6061-T6 ALUMINUM
- MIL-STD-1913 PICATINNY
- OCTAGONAL PROFILE
- FREE FLOAT
- US PAT. 8806792
- DIMENSION

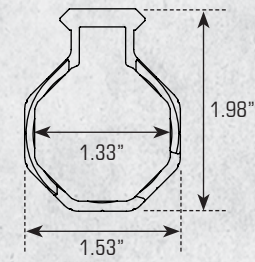

- AVAILABLE COLOR(S)**
- Black/Red Anodized
- Black/Blue Anodized
- Black/Bronze Anodized

**PARTS INCLUDED**

- M-LOK® Models: 8-Slot Picatinny Rail Section & QD Sling Swivel Adaptor
- KeyMod Models: 4-Slot & 8-Slot Picatinny Rail Sections
- Barrel Nut, Locking Ring, and Barrel Nut Wrench
- Installation Hardware

## 2-TONE

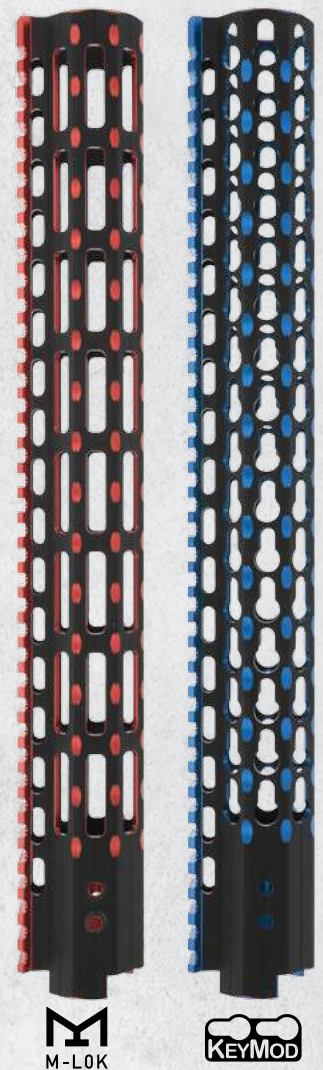

### UTG PRO® AR15 2-Tone Super Slim Free Float M-LOK® | Keymod Rail Systems

- Ergonomic Octagonal Profile with Grooved Surface for a Solid and Comfortable Grip
- M-LOK®/Keymod Slots on 7 Tracks



- MTU019SSMR2
- MTU019SSMB2
- MTU019SSMZ2

**15" RAIL**

Model #	MTU019SSMR2 / MB2 / MZ2	MTU019SSKR2 / KB2 / KZ2
Length	15.3"	15.3"
M-LOK® / Keymod Slots	49 M-LOK®	112 Keymod
Top Picatinny Slots	37	37
Net Weight	12.8 oz	12.1 oz



- MTU019SSKR2
- MTU019SSKB2
- MTU019SSKZ2

**15" RAIL**

### Additional Color Anodized Accessories Available



**Ultra Slim Handstops**  
[Also Refer to P. 149]



**UTG PRO® AR15 Mil-Spec 6 Position Receiver Extension Tubes**  
[Also Refer to P. 138]



**ACCU-SYNC® Offset Picatinny Scope Ring Mounts**  
[Also Refer to P. 050]

- MADE IN USA**
- 6061-T6 ALUMINUM
- PRECISION MACHINED
- MIL-STD-1913 PICATINNY
- TUBULAR PROFILE
- FREE FLOAT
- US PAT. 8806792
- DIMENSION

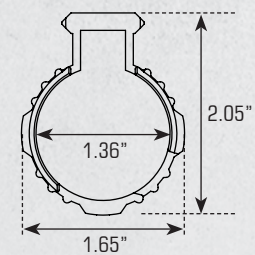

- AVAILABLE COLOR(S)**
- Matte Black Anodized
- FDE Cerakote®

**PARTS INCLUDED**

- 2-Slot Low Profile Picatinny Rail Section x3
- Barrel Nut, Locking Ring, and Barrel Nut Wrench
- Installation Hardware

### UTG PRO® AR15 Super Slim Free Float Rail Systems

- Super Slim, Compact Design with Precision Steel Barrel Nut

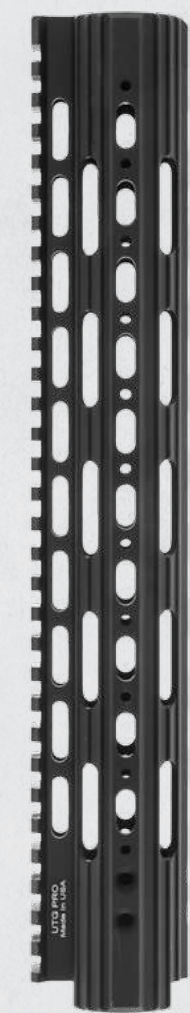

Scalloped Top Picatinny Rail Edges for Snag Free Accessories Mounting

3 Slot Tracks at the 3, 6 and 9 O'Clock Positions

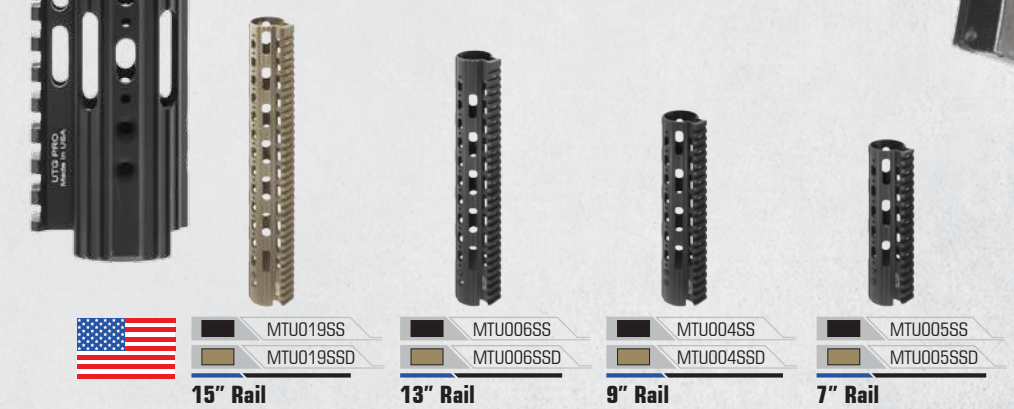

Model #	MTU019SS	MTU006SS	MTU004SS	MTU005SS
Length	15.3"	12.9"	9.6"	7.5"
Top Picatinny Slots	37	31	23	18
Net Weight	13.4 oz	12.0 oz	9.7 oz	8.4 oz

### Additional Accessories Available

For Super Slim Free Float Rail Systems Only

#### UTG PRO® Low Profile Picatinny Rail Sections

- Matte Black Anodized or Cerakote® Finish

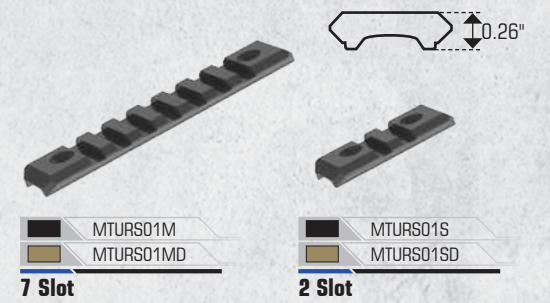

#### UTG PRO® Picatinny Rail Sections

- Continuous Rail Edge
- Matte Black Anodized or Cerakote® Finish

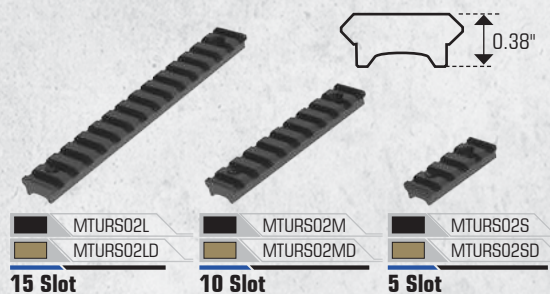

MOUNTING SYSTEMS

AR15 SUPER SLIM FREE FLOAT RAILS



# AR15 DROP-IN SUPER SLIM RAIL SYSTEMS



MADE IN USA



6061-T6 ALUMINUM



MIL-STD-1913 PICATINNY



DROP-IN



AVAILABLE COLOR(S)

Matte Black Anodized

**M-LOK® / Keymod**  
Drop-in Super Slim Rails:



PATENT PENDING



OCTAGONAL PROFILE



DIMENSION

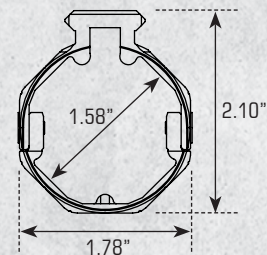

**Drop-in Super Slim Rails:**



US PAT. D711492



TUBULAR PROFILE



DIMENSION

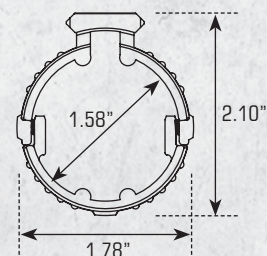

**15" RAIL CARBINE LENGTH INSTALL HANDGUARD**



**7" RAIL CARBINE LENGTH**

## UTG PRO® AR15 Drop-In Super Slim Rail Systems

- Fits Carbine Length AR15 with Standard Barrel Nut/Delta Ring Assembly and Round Front Handguard Cap and Ruger AR556
- M-LOK® Drop-in Super Slim Handguards Include 2 M-LOK® Accessories, an 8 Slot Picatinny Rail Section and a QD Sling Swivel Adaptor
- Keymod Drop-in Super Slim Handguards Include One 4 and 8 Slot Keymod Picatinny Rail Section
- Drop-in Super Slim Handguards Include 4 Rail Sections: Two 2 Slot and Two 4 Slot



Top Rail Extends to Form a Continuous Picatinny Flat Top

Scalloped Top Picatinny Rail Edges for Snag Free Accessories Mounting



Fits Carbine Length AR15 with Standard Barrel Nut / Delta Ring Assembly and Round Front Handguard Cap and Ruger AR556

Extended Drop-in Design with Cutout for Standard A2 Front Sight (MTU015SSM / MTU015SSK / MTU015SS Only)



15 INCH MTU015SSM  
7 INCH MTU001SSM

**M-LOK® Drop-In Super Slim Rails**

15 INCH MTU015SSK  
7 INCH MTU001SSK

**Keymod Drop-In Super Slim Rails**

15 INCH MTU015SS  
7 INCH MTU001SS

**Drop-In Super Slim Rails**

Model #	MTU015SSM	MTU001SSM	MTU015SSK	MTU001SSK	MTU015SS	MTU001SS
Length	15.0"	7.3"	15.0"	7.3"	15.0"	7.3"
M-LOK/Keymod Slots	45 M-LOK	24 M-LOK	89 Keymod	45 Keymod	N/A	N/A
Top Picatinny Slots	31	18	31	18	32	18
Net Weight	12.4 oz	6.2 oz	12.2 oz	9.0 oz	14.1 oz	6.9 oz



## Additional Accessories Available



M-LOK MT-AFGM01  
KEYMOD MT-AFGK01

**M-LOK®/Keymod Angled Foregrips**  
[Also Refer to P. 148]



M-LOK TL-TRM01  
KEYMOD TL-TRK01

**M-LOK®/Keymod Angled Index Mounts**  
[Also Refer to P. 148]



**UTG PRO® Rail Sections**  
• For Drop-in Super Slim Rail Systems Only  
• Matte Black Anodized



2 Slot MTURS03S



4 Slot MTURS03M





# AR15 DROP-IN QUAD RAIL SYSTEMS



MADE IN USA



6061-T6 ALUMINUM



PRECISION MACHINED



MIL-STD-1913 PICATINNY



AVAILABLE COLOR(S)

Matte Black Anodized

Army Digital Pixedized

## UTG PRO® AR15 Drop-In Quad Rail Systems

- Durable Finishes Provide Excellent Resistance to Corrosion and Wear
- Great Zero-retention for All Accessories Installed on Rails



MTU001

MTU001R

### UTG PRO® AR15 Drop-In Carbine Length Quad Rail

- 2-piece Design with Alignment Housing for a Perfect Fit with the Standard Barrel Nut/Delta Ring Assembly and Round Front Handguard Cap



For Use with Round Front Handguard Cap



12 Pc. Rubber Rail Guards Included



MTU007

### UTG PRO® AR15 Drop-In Mid-Length Quad Rail

- 2-piece Design with Integral Spinal Cords/Alignment Housing for Precise Fit
- Designed to be Compatible with Standard Triangular Front Handguard Cap



MTU007

### UTG PRO® AR15 Drop-In Carbine Length Quad Rail with Continuous Top Rail

- Extended Top Rail Provides a Continuous Unimpeded Flat Top
- 2-piece Design with Alignment Housing for a Perfect Fit with the Standard Barrel Nut/Delta Ring Assembly and Round Front Handguard Cap



Extended Top Rail Provides a Continuous Unimpeded Flat Top



For Use with Round Front Handguard Cap



12 Pc. Rubber Rail Guards Included

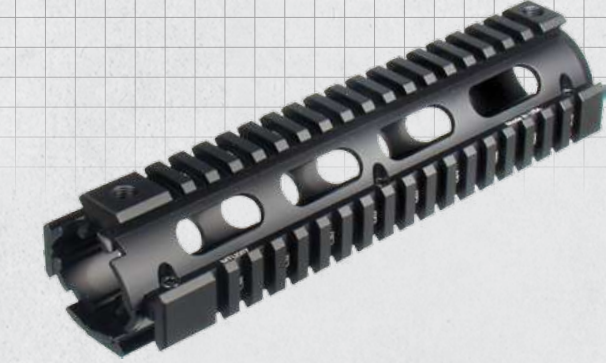

MTU007

### UTG PRO® AR15 Drop-In Carbine Length Quad Rail with Forward Extension

- 2-piece Design with Integral Spinal Cords/Alignment Housing for a Perfect Fit with the Standard Barrel Nut/Delta Ring Assembly and Round Front Handguard Cap
- Designed with Cutout to Accommodate Front Sight, Sling Swivel, and Bayonet Lug



For Use with Triangular Front Handguard Cap



18 Pc. Rubber Rail Guards Included



MTU015

### UTG PRO® AR15 Drop-In Carbine Length Quad Rail

- 3-piece Design with Integral Spinal Cords/Alignment Housing for a Perfect Fit with the Standard Barrel Nut/Delta Ring Assembly and Round Front Handguard Cap
- Designed with Cutout to Accommodate Front Sight, Sling Swivel, and Bayonet Lug



For Use with Round Front Handguard Cap



18 Pc. Rubber Rail Guards Included



## Additional Accessories Available



MT-AFGP01

**Picatinny Angled Foregrip**  
[Also Refer to P. 148]



MT-FGP01

**Picatinny Super Slim Aluminum Vertical Foregrip**  
[Also Refer to P. 150]



RB-HP27B (6/PACK)

**Low Profile Picatinny Panel Covers**  
[Also Refer to P. 153]



TL-SWPM01

**Low Profile Angled QD Sling Swivel Picatinny Adaptor**  
[Also Refer to P. 156]

Model #	MTU001 / MTU001R	MTU001T	MTU007	MTU015
Length	6.7"	7.3"	8.7"	10.7"
Top / Bottom / Left / Right Picatinny Slots	T:14 / B:14 / L:14 / R:14	T:18 / B:17 / L:16 / R:16	T:18 / B:18 / L:18 / R:18	T:19 / B:22 / L:25 / R:25
Net Weight	11.3 oz	11.3 oz	14.7 oz	17.1 oz



# AR308 SUPER SLIM FREE FLOAT M-LOK® RAIL SYSTEMS

- MADE IN USA**
- 6061-T6 ALUMINUM
- PRECISION MACHINED
- MIL-STD-1913 PICATINNY
- OCTAGONAL PROFILE
- FREE FLOAT
- US PAT. 8806792
- AVAILABLE COLOR(S)  
■ Matte Black Anodized
- PARTS INCLUDED



## UTG PRO® AR308 Super Slim Free Float M-LOK® Rail Systems

- 4 Versions with Included Precision Steel Barrel Nut to Fit Specific Models and Clones (See Details Below)
- Ergonomic Octagonal Profile with M-LOK® Slots on 7 Tracks



Scalloped Top Picatinny Rail Edges for Snag Free Accessories Mounting

Ergonomic Finger Grooves for a Solid and Comfortable Grip



M-LOK® 8-Slot Picatinny Rail Section & QD Sling Swivel Adaptor



Installation Hardware

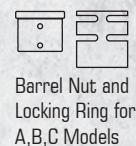

Barrel Nut and Locking Ring for A,B,C Models



Barrel Nut and Locking Ring for E Model



Barrel Nut Wrench



Traditional Handguard Super Slim Handguard

Super Slim Design for Comfort and Weight Reduction



Flush Fitting and Continuous with Upper Receiver



Integral Anti-rotation Tabs for Accurate Alignment with Upper Receiver

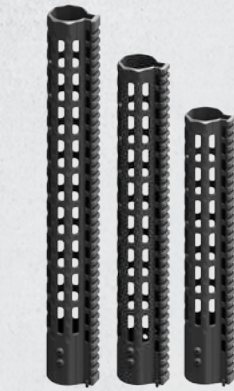

- 13 INCH MTU020SSMB
- 15 INCH MTU026SSMB
- 17 INCH MTU038SSMB

**DPMS LR-308 High Profile**

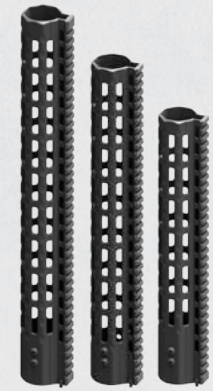

- 13 INCH MTU020SSMC
- 15 INCH MTU026SSMC
- 17 INCH MTU038SSMC

**S&W M&P10 / DPMS LR-308 Low Profile**

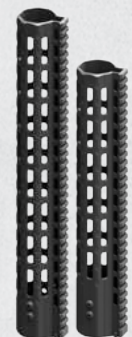

- 13 INCH MTU020SSME
- 15 INCH MTU026SSME

**DPMS Gen II**



- 15 INCH MTU026SSMA

**ARMALITE® AR-10**



## Additional M-LOK® Accessories Available



MT-AFGM01

**M-LOK® Angled Foregrip**  
[Also Refer to P. 148]

RB-HP30MB (4/PACK)

**Low Profile M-LOK® Rail Panel Covers**  
[Also Refer to P. 153]

Medium Profile TL-BPDM01  
High Profile TL-BPDM02

**M-LOK® Recon Flex™ Bipods**  
[Also Refer to P. 106]

Model #	MTU020SSMB MTU020SSMC MTU020SSME	MTU026SSMA MTU026SSMB MTU026SSMC MTU026SSME	MTU038SSMB MTU038SSMC
Length	12.7"	15.1"	17.1"
M-LOK® Slots	42	56	63
Top Picatinny Slots	31	37	42
Net Weight	Model B - 14.2 oz Model C - 14.0 oz Model E - 14.7 oz	Model A&B - 15.8 oz Model C - 15.5 oz Model E - 16.3 oz	Model B - 17.4 oz Model C - 17.1 oz Model E - 18.0 oz

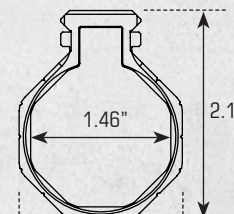

Model A & B

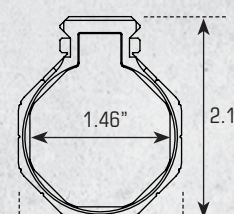

Model C

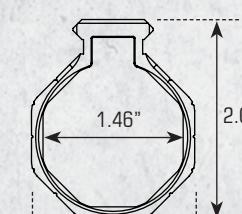

Model E





# AR308 SUPER SLIM FREE FLOAT KEYMOD RAIL SYSTEMS

MOUNTING SYSTEMS

AR308 SUPER SLIM FREE FLOAT KEYMOD RAILS

- MADE IN USA
- 6061-T6 ALUMINUM
- PRECISION MACHINED
- MIL-STD-1913 PICATINNY
- OCTAGONAL PROFILE
- FREE FLOAT
- US PAT. 8806792
- AVAILABLE COLOR(S)  
■ Matte Black Anodized
- PARTS INCLUDED

- Keymod 4-Slot & 8-Slot Picatinny Rail Sections
- Barrel Nut & Locking Ring
- Installation Hardware
- Barrel Nut Wrench



## UTG PRO® AR308 Super Slim Free Float Keymod Rail Systems

- 3 Versions with Included Precision Steel Barrel Nut to Fits Specific Models and Clones (See Details Below)

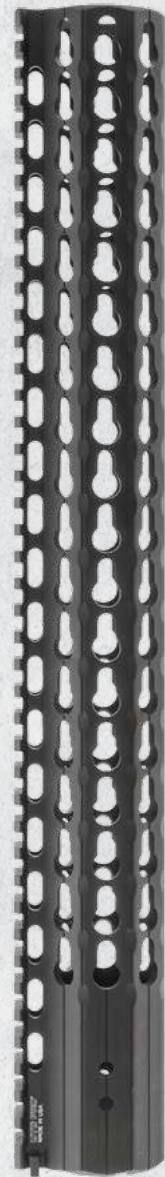

Scalloped Top Picatinny Rail Edges for Snag Free Accessories Mounting

Ergonomic Finger Grooves for a Solid and Comfortable Grip

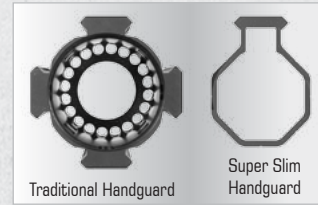

Super Slim Design for Comfort and Weight Reduction



Flush Fitting and Continuous with Upper Receiver

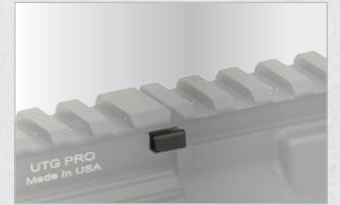

Integral Anti-rotation Tabs for Accurate Alignment with Upper Receiver

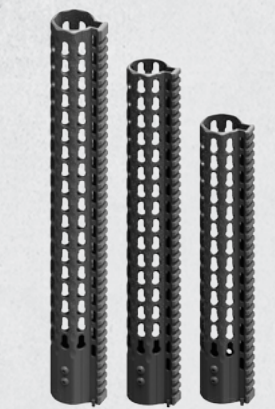

- 13 INCH MTU020SSKB
- 15 INCH MTU026SSKB
- 17 INCH MTU038SSKB

DPMS LR-308 High Profile

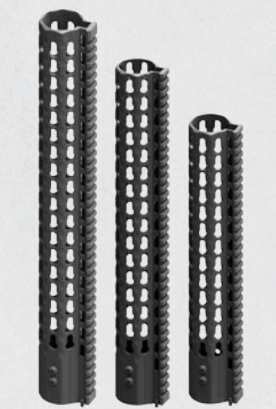

- 13 INCH MTU020SSKC
- 15 INCH MTU026SSKC
- 17 INCH MTU038SSKC

S&W M&P10 / DPMS LR-308 Low Profile



- 15 INCH MTU026SSKA

ARMALITE® AR-10



## Additional Keymod Accessories Available



UTG PRO® Keymod QD Sling Swivel Adaptors [Also Refer to P. 156]



Keymod Super Slim Aluminum Vertical Foregrip [Also Refer to P. 150]



Low Profile Keymod Rail Panel Covers [Also Refer to P. 153]

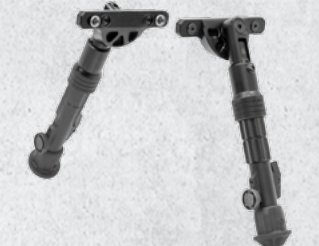

Keymod Recon Flex™ Bipods [Also Refer to P. 106]

Model #	MTU020SSKB MTU020SSKC	MTU026SSKA MTU026SSKB MTU026SSKC	MTU038SSKB MTU038SSKC
Length	12.7"	15.1"	17.1"
Keymod Slots	91	112	126
Top Picatinny Slots	31	37	42
Net Weight	Model B -13.5 oz Model C -13.2 oz	Model A&B -14.9 oz Model C -14.4 oz	Model B -17.8 oz Model C -17.6 oz

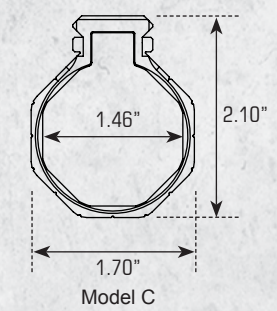
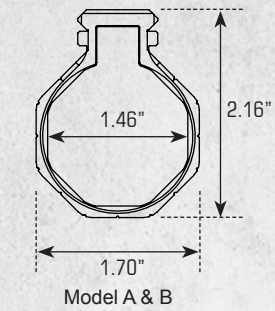

MOUNTING SYSTEMS

AR308 SUPER SLIM FREE FLOAT KEYMOD RAILS



# AR308 SUPER SLIM FREE FLOAT RAIL SYSTEMS



# AR308 DROP-IN QUAD RAIL

Mounting Systems

AR308 Super Slim Free Float Rails

- MADE IN USA**
- 6061-T6 ALUMINUM
- PRECISION MACHINED
- MIL-STD-1913 PICATINNY
- TUBULAR PROFILE
- FREE FLOAT
- US PAT. 8806792
- AVAILABLE COLOR(S)  
■ Matte Black Anodized
- PARTS INCLUDED

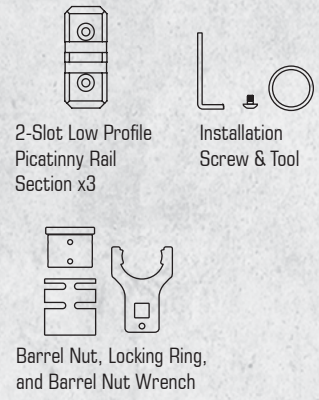

## UTG PRO® AR308 Super Slim Free Float Rail Systems

- 3 Versions with Included Precision Steel Barrel Nut to Fits Specific Models and Clones (See Details Below)
- Lightweight Continuous with Upper Receiver
- Includes 3 User Configurable 2 Slot Rail Sections



MTU020SSA

### ARMALITE® AR-10

MTU020SSB

### DPMS LR-308 High Profile

MTU020SSC

### S&W M&P10 / DPMS LR-308 Low Profile

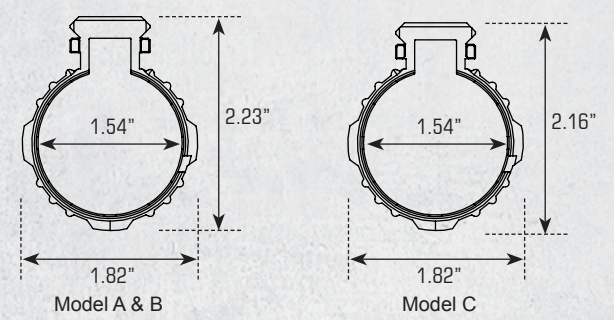

Model #	MTU020SSA	MTU020SSB	MTU020SSC
Length	12.7"	12.7"	12.7"
Top Picatinny Slots	31	31	31
Net Weight	14.7 oz	14.7 oz	14.0 oz

## Additional Accessories Available

For Super Slim Free Float Rail Systems Only

### UTG PRO® Low Profile Picatinny Rail Section

- Matte Black Anodized or Cerakote® Finish

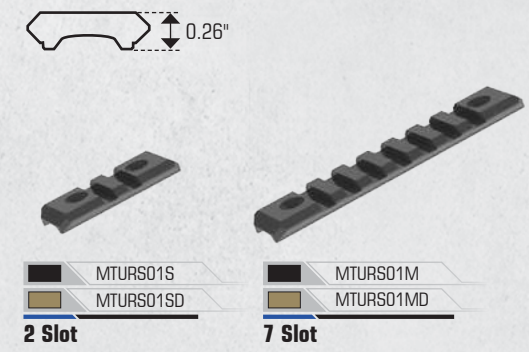

### UTG PRO® Picatinny Rail Section

- Continuous Rail Edge Design for Optimal Accessory Attachment
- Matte Black Anodized or Cerakote® Finish

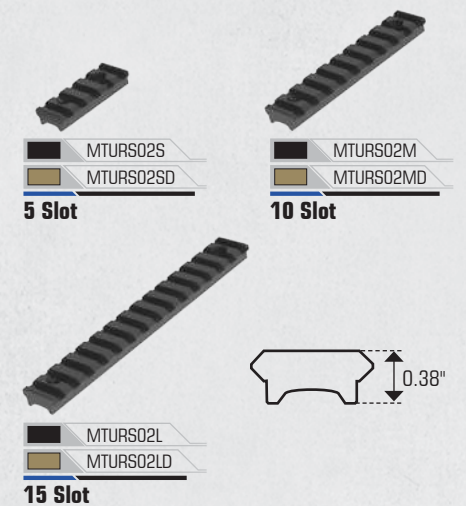

MADE IN USA

- 6061-T6 ALUMINUM
- PRECISION MACHINED
- MIL-STD-1913 PICATINNY
- DROP-IN
- QUAD RAIL
- DIMENSION

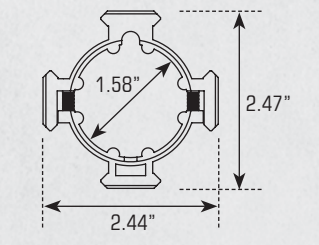

- AVAILABLE COLOR(S)  
■ Matte Black Anodized

## UTG PRO® AR308 Drop-In Mid Length Quad Rail

- Compatible with Smith & Wesson M&P10 and Clones



Model #	MTU018
Length	8.7"
Top / Bottom / Left /Right Picatinny Slots	T:19 / B:19 / L:19 / R:19
Net Weight	14.7 oz



9 INCH MTU018 S&W M&P10



For Use with Round Front Handguard Cap



16 Pc. Rubber Rail Guards Included

Mounting Systems

AR308 Drop-In Quad Rail



# RDM20 REFLEX MICRO DOT SUPER SLIM MOUNTS

6061-T6 ALUMINUM

PRECISION MACHINED

AVAILABLE COLOR(S)

Matte Black Anodized

RDM-2045 & RDM-20AC:

MIL-STD-1913 PICATINNY

RDM-20GL, RDM-20SIG, & RDM-20SW:

REAR SIGHT DOVETAIL

## RDM20 Reflex Micro Dot Super Slim Mounts

- Lightening Cuts Reduce Overall Weight (Excludes Dovetail Models)



Utilizes Locking Torx Screws and Square-shaped Integral Recoil Stops for a Secure Zero Hold (RDM-20GL, RDM-20SIG, and RDM-20SW)



Utilizes Locking Torx Screws and Steel Dovetail Insert for a Secure Zero Hold (RDM-20GL, RDM-20SIG, and RDM-20SW)



RDM20

NEW



RDM20 RDM-2045  
45 Degree Angled Mount



RDM20 RDM-20AC  
Absolute Co-Witness Mount



RDM20 RDM-20GL  
Glock Double Stack Rear Sight Mount



RDM20 RDM-20SIG  
SIG P-Series Double Stack Rear Sight Mount



RDM20 RDM-20SW  
S&W M&P Double Stack Rear Sight Mount



RED DOT SCP-RDM20R  
GREEN DOT SCP-RDM20G

## Reflex Micro Dot

- 4 MOA Illuminated Single Dot with 6 Variable Brightness Settings
  - 1-Click Illumination Memory Feature Gets the User Right Back to the Brightness Setting Last Used
  - Windage and Elevation Adjustable with 1 MOA/Click Adjustment at 100 Yds
  - Adaptive Mount Base Includes Universal MIL-STD-1913 Picatinny Mount and is Compatible with Glock MOS #1, #5, S&W CORE™ #5 Plates, and Other Equivalently Manufactured Plates
- [Also Refer to P. 040]**



Model #	RDM-2045	RDM-20AC	RDM-20GL	RDM-20SIG	RDM-20SW
Length / Width	1.8" / 2.5"	1.8" / 1.1"	1.8" / 1.1"	1.8" / 1.1"	1.8" / 1.1"
Saddle Height	N/A	0.78"	0.15"	0.16"	0.16"
Weight	1.5 oz	1.5 oz	0.5 oz	0.5 oz	0.5 oz



# RMR® | T1 | MRO® SUPER SLIM MOUNTS

6061-T6 ALUMINUM

PRECISION MACHINED

AVAILABLE COLOR(S)

Matte Black Anodized

All Models (Excludes MT-RMRGL):

MIL-STD-1913 PICATINNY

MT-RMRGL:

REAR SIGHT DOVETAIL

## RMR® | T1 | MRO® Super Slim Mounts

- Utilizes Locking Torx Screws and Square-shaped Integral Recoil Stops or Rear Sight Dovetail Insert for a Secure Zero Hold
- Significant Lightening Cuts Reduce Overall Weight and Bulk (Excludes Low Profile and Dovetail Models)



45 Degree Angled



Lower 1/3 Co-Witness



Absolute Co-Witness



Low Profile



Rear Sight Dovetail

## RMR



RMR MT-RMR45  
45 Degree Angled Mount



RMR MT-RMRAC  
Absolute Co-Witness Mount



RMR MT-RMRXS  
Low Profile Mount



RMR MT-RMR13C  
Lower 1/3 Co-Witness Mount



RMR MT-RMRGL  
Glock Double Stack Rear Sight Mount

## RMR MT-RMRKIT 2-In-1 Combo

## T1



Additionally Compatible with Aimpoint® H1, H2, T2, and CompM5



T1 MT-T1AC  
Absolute Co-Witness Mount



T1 MT-T113C  
Lower 1/3 Co-Witness Mount

## MRO



MRO MT-MROAC  
Absolute Co-Witness Mount



MRO MT-MRO13C  
Lower 1/3 Co-Witness Mount



MRO MT-MRO13C  
Lower 1/3 Co-Witness Mount



MRO MT-MROXS  
Low Profile Mount

Model #	MT-RMR45	MT-RMR13C	MT-RMRKIT		MT-RMRGL	MT-T1AC	MT-T113C	MT-MROAC	MT-MRO13C	MT-MROXS
			MT-RMRAC	MT-RMRXS						
Length / Width	1.8" / 2.5"	1.8" / 1.1"	1.8" / 1.1"	1.8" / 1.1"	1.8" / 1.1"	1.9" / 1.2"	1.9" / 1.2"	1.5" / 1.2"	1.5" / 1.2"	1.5" / 1.2"
Saddle Height	N/A	0.95"	0.87"	0.40"	0.16"	0.96"	1.06"	0.73"	0.86"	0.20"
Weight	1.4 oz	1.6 oz	1.5 oz	1.4 oz	0.4 oz	1.3 oz	1.3 oz	0.9 oz	0.9 oz	0.6 oz



# UNIVERSAL SUPER SLIM RISER MOUNTS

- 6061-T6 ALUMINUM
- PRECISION MACHINED
- MIL-STD-1913 PICATINNY
- AVAILABLE COLOR(S)
  - Matte Black Anodized

### MT-RSX5S & MT-RSX5L:

US PAT. D784482

DIMENSION

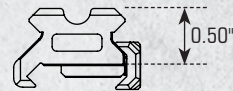

### MT-RSX7S & MT-RSX7L:

US PAT. D784483

DIMENSION

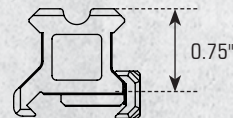

### MT-RSX8S & MT-RSX8L:

DIMENSION

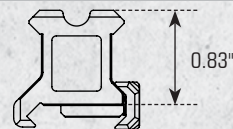

### MT-RSX1S & MT-RSX1L:

US PAT. D784481

DIMENSION

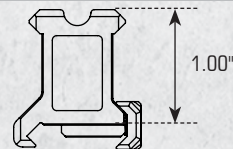

## Universal Super Slim Riser Mounts

- Significant Lightening Cuts Reduce Overall Weight and Bulk (Medium and High Profile Only)



0.50" MT-RSX5S  
 0.75" MT-RSX7S  
 0.83" MT-RSX8S  
 1.00" MT-RSX1S  
**3 Slot**



0.50" MT-RSX5L  
 0.75" MT-RSX7L  
 0.83" MT-RSX8L  
 1.00" MT-RSX1L  
**13 Slot**



MT-RSX20MOA  
**13 Slot / 20 MOA Elevated Compensation**

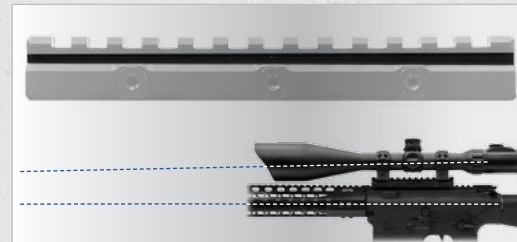

20MOA Compensation Maximizes Optic Elevation Adjustment for Zeroing at Long Range Distances



Utilizes Locking Torx Screws and Square-shaped Integral Recoil Stops for a Secure Zero Hold



Rail Slots Index Perfectly with Handguard or Flat Top Slots



Multiple Riser Mounts Form One Continuous Picatinny Rail (Excludes MT-RSX20MOA)

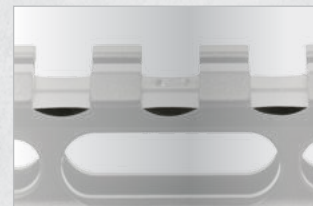

Scalloped Picatinny Slots for Snag Free Accessory Mounting

Model #	MT-RSX5S	MT-RSX7S	MT-RSX8S	MT-RSX1S	MT-RSX5L	MT-RSX7L	MT-RSX8L	MT-RSX1L	MT-RSX20MOA
Length	1.6"	1.6"	1.6"	1.6"	5.5"	5.5"	5.5"	5.5"	5.5"
Saddle Height	0.50"	0.75"	0.83"	1.00"	0.50"	0.75"	0.83"	1.00"	N/A
Picatinny Slots	3	3	3	3	13	13	13	13	13
Weight	0.9 oz	0.9 oz	1.0 oz	1.0 oz	2.7 oz	2.7 oz	2.8 oz	2.8 oz	2.7 oz



# UNIVERSAL RISER MOUNTS

## Universal Riser Mounts

- Precision Machined from Aircraft Aluminum with a Matte Black Finish
- Universal Riser Mount Fits All Picatinny Rails



0.59" MNT-RSQD403  
**3 Slot / QD Lever Lock**

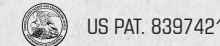

0.59" MNT-RSQD605  
**5 Slot / QD Lever Lock**



QD Lever Lock

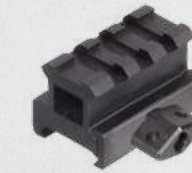

0.50" MNT-RS05S2  
**2 Slot / Twist Lock**



Twist Lock



0.50" MNT-RS05L  
 0.75" MNT-RS08L  
 0.83" MNT-RS10L  
**13 Slot / Thumb Knob**



Thumb Lock



Laser Application



Foregrip Application



Optic Application



STANAG Compatible

Model #	MNT-RSQD403	MNT-RSQD605	MNT-RS05S2	MNT-RS05S3	MNT-RS08S3	MNT-RS10S3	MNT-RS05L	MNT-RS08L	MNT-RS10L
Length	1.6"	2.4"	1.2"	1.6"	1.6"	1.6"	5.5"	5.5"	5.5"
Saddle Height	0.59"	0.59"	0.50"	0.50"	0.83"	1.00"	0.50"	0.75"	0.83"
Locking Method	QD Lever Lock	QD Lever Lock	Twist Lock	Twist Lock	Twist Lock	Twist Lock	Thumb Knob	Thumb Knob	Thumb Knob
Picatinny Slots	3	5	2	3	3	3	13	13	13
Weight	2.3 oz	3.0 oz	1.1 oz	1.3 oz	1.9 oz	1.7 oz	4.2 oz	6.1 oz	6.9 oz



# AR15 MICRO GAS BLOCKS

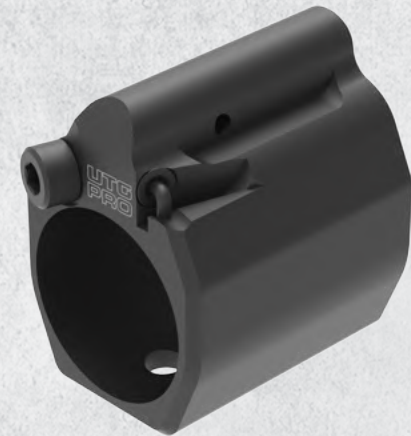

MTU012AG7

## UTG PRO® AR15 Adjustable Micro Gas Block

- 12 Position Gas Port Adjustments
- Low Profile, Fits Underneath Most Free Float Handguards
- Precision Machined Steel to Exacting Tolerances for .750" Diameter Barrels at the Gas Port
- Durable and Corrosion Resistant Manganese Phosphate Finish
- Includes Gas Tube Roll Pin, Serrated Self-locking Set Screws, Adjustment Tool, and Installation Tool

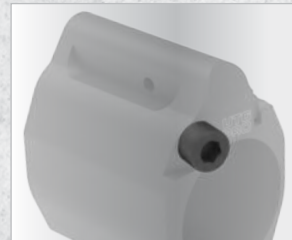

12 Position Gas Port Adjustments



Low Profile, Fits Underneath Most Free Float Handguards

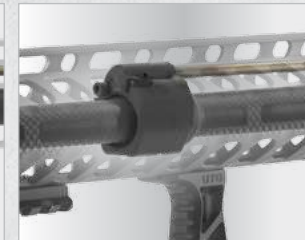

Compatible with Direct Impingement Systems

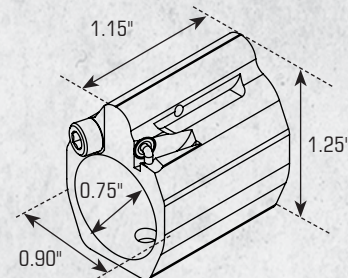

Model #	MTU012AG7
Inner Diameter	0.750"
Length	1.2"
Width	0.9"
Height	1.3"
Weight	1.9 oz



MNT-ARMGB01

## AR15 Micro Gas Block

- Low Profile, Fits Underneath Most Free Float Handguards
- Precision Machined Steel to Exacting Tolerances for .750" Diameter Barrels at the Gas Port
- Durable and Corrosion Resistant Manganese Phosphate Finish
- Includes Gas Tube Roll Pin, Serrated Self-locking Set Screws, and Installation Tool



Precision Machined Steel to Exacting Tolerances

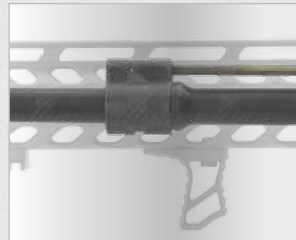

Low Profile, Fits Underneath Most Free Float Handguards



Compatible with Direct Impingement Systems

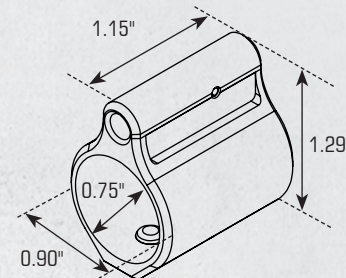

Model #	MNT-ARMGB01
Inner Diameter	0.750"
Length	1.2"
Width	0.9"
Height	1.3"
Weight	1.5 oz



# AR15 CARRY HANDLE | BARREL | HANDGUARD RAIL MOUNTS



MNT-993

## AR15 Carry Handle Rail Mount

- 12 Slot Top Picatinny Rail with Secondary Integral STANAG Mounting Base
- Constructed from Aircraft Aluminum with a Matte Black Finish
- Allows Use of Iron Sights
- Secured via Locking Knurled Thumb Nut



STANAG Compatible

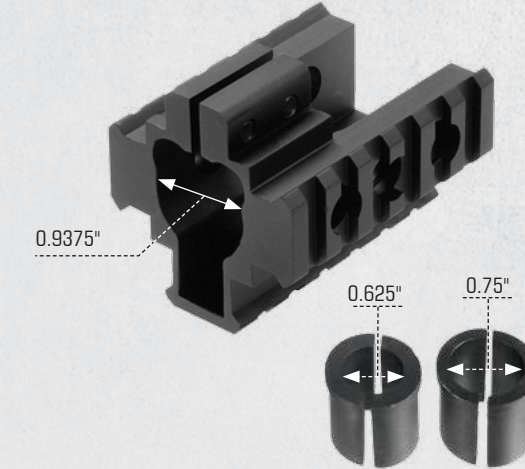

MNT-BR101TR-A

## AR15 Tri-Rail Barrel Mount

- AR15 Tri-rail Barrel Mount Compatible with A2 Front Sight with Bayonet Lug
  - Includes 2 Sets of Barrel Adaptors for Fitting on Standard, Bull, or Lightweight Barrel Profiles
  - Integral Sling Swivel Housing for Installation of Optional QD Sling Swivel TL-QDSW28
- [Also Refer to P. 157]

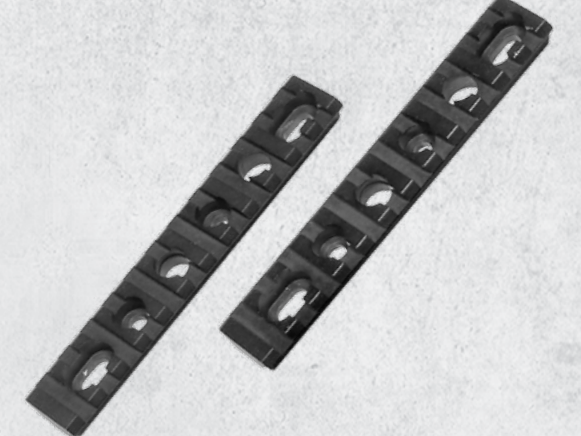

MNT-HGR16S

## Deluxe AR15 Handguard Picatinny Rails

- Compatible with AR15 Standard 2-piece Plastic handguard
- Includes Two Picatinny Rails with 12 Slots each for Installation at the 12 and 6 O'Clock Positions
- Complete with Mounting Hardware, Swivel Stud Housing, and Swivel Stud Adaptor



Tapered Design Mates with the Top and Bottom Handguards



# AK SUPER SLIM KEYMOD RAIL SYSTEMS

- MADE IN USA**
- 6061-T6 ALUMINUM
- PRECISION MACHINED
- MIL-STD-1913 PICATINNY
- OCTAGONAL PROFILE
- 922R COMPLIANT
- US PAT. D751663
- DIMENSION

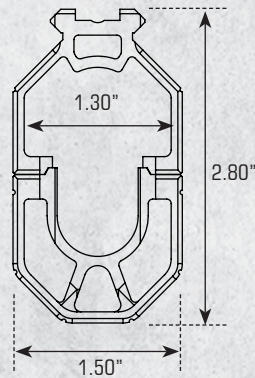

- AVAILABLE COLOR(S)**  
Matte Black Anodized
- PARTS INCLUDED**

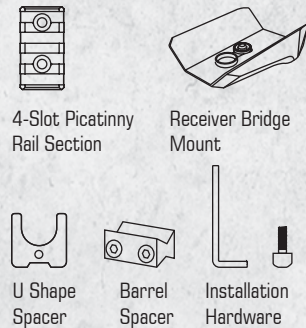

## THE AK REBORN



### UTG PRO® AK Super Slim Keymod Rail Systems

- Top and Bottom 2-piece Design with Internal Locking Screw Placement
- Ergonomic Octagonal Profile with Grooved Surface for a Solid Grip

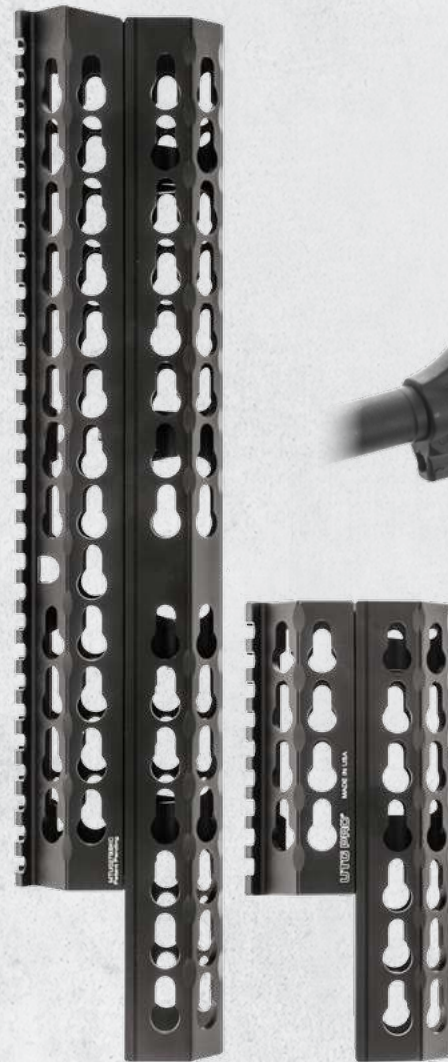

Ergonomic Finger Grooves for a Solid and Comfortable Grip



Scalloped Top Picatinny Rail Edges for Snag Free Accessory Mounting

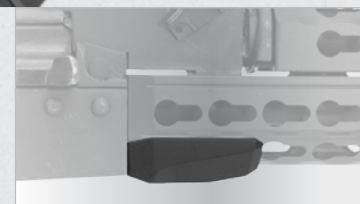

Receiver Bridge Mount for Smooth Interface with AK Receiver



MTU027SSKA

**13.5" Rail**  
Compatible with Romanian, Bulgarian AKs or Clones Equipped with Handguard Retainer Sling Loop

MTU027SSKC

**13.5" Rail**  
Compatible with Chinese AKs or Clones with Gas Block Sling Loop

MTU009SSK

**6" Rail**  
Compatible with Romanian, Bulgarian, and Chinese AKs or Clones

Model #	MTU027SSKA	MTU027SSKC	MTU009SSK
Length	13.5"	13.5"	6.0"
Keymod Slots	121	122	51
Top Picatinny Slots	28	28	9
Net Weight	13.6 oz	13.6 oz	5.1 oz



### Additional Keymod Accessories Available



MT-AFGK01  
**Keymod Angled Foregrip**  
[Also Refer to P. 148]



MT-FGK01  
**Keymod Super Slim Aluminum Vertical Foregrip**  
[Also Refer to P. 150]



TL-TRK01  
**Keymod Angled Index Mount**  
[Also Refer to P. 148]



TL-HSK01  
**Keymod Ultra Slim Hand Stop**  
[Also Refer to P. 149]



RB-HP25B (4/PACK)  
**Low Profile Keymod Rail Panel Covers**  
[Also Refer to P. 153]



TL-HS02B  
**Keymod Hand Stop/Barricade Rest Kit**  
[Also Refer to P. 149]



# AK QUAD RAIL SYSTEMS



MADE IN USA



6061-T6 ALUMINUM



PRECISION MACHINED



MIL-STD-1913 PICATINNY



922R COMPLIANT



DROP IN



AVAILABLE COLOR(S)

Matte Black Anodized

## UTG PRO® AK Quad Rail Systems

- Integrally Machined QD Sling Swivel Housings
- Low Profile Top Rail with V-cut for Using Iron Sights



MTU009

### UTG PRO® Romanian/Chinese/US AK Quad Rail System

- Universal Design Fits Romanian, Bulgarian, Chinese, and US AKs or Clones Including Those with an Oversized Barrel and Rear Sight Block



12 Pc. Rubber Rail Guards Included



MTU010

### UTG PRO® AMD-65 Quad Rail System

- Fits Hungarian AMD-65 and Clones



12 Pc. Rubber Rail Guards Included



MTU011

### UTG PRO® YUGO AK Quad Rail System

- Fits Yugo AKs and Clones
- Also Compatible with Zastava N-PAP Series After Removal of Rear Handguard Retainer



11 Pc. Rubber Rail Guards Included



# AK SIDE MOUNT & LOW PROFILE QD RAIL SYSTEM



MTU016

### UTG PRO® AK Quick Detach Side Mount

- Precision Machined from 6061-T6 Aircraft Aluminum with a Matte Black Anodization
- Lightweight Design with U-cut Channel Top Rail for Reduced Weight
- Equipped with a 16 Slot Picatinny Top Rail and Detachable 6 Slot Side Rail
- Fits Most AKs and Clones with Side Optic Rail

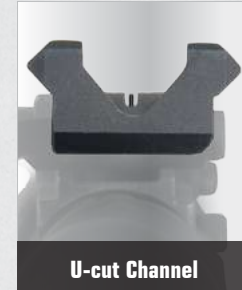

U-cut Channel



TL-M47SR

### UTG AK Steel Side Plate

- Durable Steel Construction with a Matte Black Finish
- Fits Both Milled and Stamped AK Receivers and Accepts a Wide Variety of Side Optic Mounts
- Permanent Modification Required



MTU014

### UTG PRO® AK QD Low Profile Top Rail System

- Low Profile 19 Slot Picatinny Top Rail
- Fits Romanian, Chinese, and US AKs or Clones, as well as, Saigas Equipped with Rear Sight Blade and Fixed Butt Stock
- **NOTE:** Does Not Work with Milled Receivers with a Slanted Tang



Precision Machined from 6061-T6 Aircraft Aluminum with a Matte Black Anodization



Quick Detachable for Ease of Disassembly and Maintenance



Adjustable Rear Block for Installation on Different AKs or Clones



Low Profile Design



Complete with Back-up Windage-adjustable Rear Sight



Convenient and Reliable Lock/Release Push Button

Model #	MTU009	MTU010	MTU011
Length / Width	8.4" / 2.1"	8.4" / 2.1"	6.5" / 2.1"
Top / Bottom / Left /Right Picatinny Slots	T:14 / B:14 / L:14 / R:14	T:15 / B:14 / L:14 / R:14	T: 9 / B:15 / L:15 / R:15
Net Weight	9.2 oz	9.2 oz	9.5 oz



# SKS | MOSIN NAGANT MOUNTS



922R COMPLIANT

MTU017

### UTG PRO® SKS Receiver Cover with Integrated Picatinny Rail and Shell Deflector

- Precision Cast and Machined High-strength Steel Base
- Top Rail Precision Machined from 6061-T6 Aircraft Aluminum with a Matte Black Anodization
- Full Length 22 Slot Top Picatinny Rail
- Precise and Repeatable 4 Point Locking Engagement of Receiver



U-cut Channel

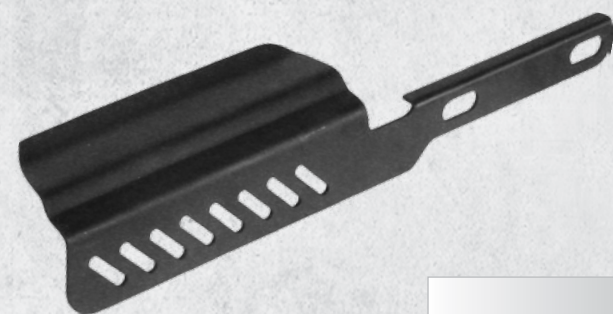

TL-SDSK01

### SKS Shell Deflector

- Made from Spring Steel with a Matte Black Finish
- Deflects Ejecting Spent Cartridges Away from Optics that May be Mounted
- Installation Screw Holes Compatible with UTG SKS Tri-Rail Mount, High Profile Mount, and Other Similar SKS Mounts

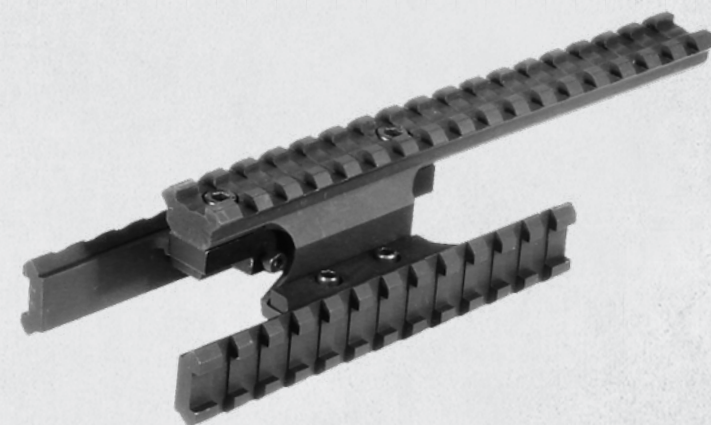

MNT-MNTR01

### Mosin Nagant Tri-rail Mount

- Steel Base with Adaptors to Fit the Rear Sight Housing of Full or Carbine Length Rifles
- Tri-rail Made from Aircraft Aluminum with a Matte Black Finish
- Extended Top Rail with 17 Slots to Provide Ample Space for Eye Relief Adjustment
- Removable 12 Slot Side Rails



X4

4 Pc. Rubber Rail Guards Included



Model #	MTU017	TL-SDSK01	MNT-MNTR01
Length / Width	9.1" / 2.1"	7.5" / 1.2"	8.0" / 2.4"
Net Weight	12.1 oz	2.1 oz	9.2 oz



# SHOTGUN MOUNTS

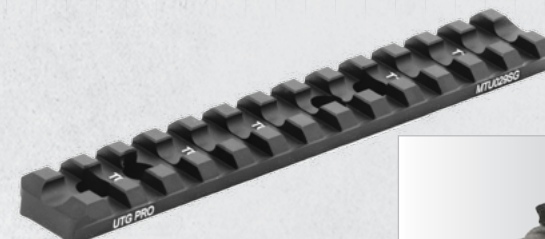

MTU029SG

### UTG PRO® Mossberg 500 Optic Mount

- The Michigan Difference - Enhanced Precision, Material Strength, and Quality Control
- Compatible with Drilled and Tapped Mossberg Shotguns
- **NOTE:** The Screws Included are for Mossberg 500s Made After 1998. For Earlier Versions, Please Contact Leapers for Appropriate Screws

MNT-MB500T • Overseas Production



MTU028SG

### UTG PRO® Remington 870 Optic Mount

- Precision Machined from Aircraft Aluminum with a Matte Black Anodized Finish
- Fits Drilled and Tapped Remington Model 870 / 1100 Shotguns and Clones



MNT-RM870A

### Remington 870 Optic Mount

- Fits 12 Ga Remington 870 Shotguns and Clones with Up to a 3" Chamber
- Precision Machined from Aircraft Aluminum with a Matte Black Finish
- Locking Bolts Directly Replaces Original Receiver Pins



922R COMPLIANT

MTU002

### UTG PRO® Saiga 12 Quad Rail System

- Fits Saiga 12 Ga. and Clones
- Precision CNC Machined from Aircraft Aluminum with a Matte Black Anodized Finish



Short Top Rail / 20 Slot

Long Top Rail / 31 Slot

Two Different Top Rails Provided



X12

12 Pc. Rubber Rail Guards Included



See-thru Top Rail



Model #	MTU029SG	MNT-MB500T	MTU028SG	MNT-RM870A	MTU002
Length / Width	5.5" / 0.4"	5.5" / 0.4"	6.1" / 0.8"	7.5" / 1.9"	13.7" / 2.3"
Top / Bottom / Left / Right Picatinny Slots	T: 13	T: 13	T: 14	T: 14	T: 28 / B:20 / L: 20 / R:20
Net Weight	1.2 oz	1.4 oz	1.6 oz	5.5 oz	17 oz





# M14 | M1 | 10/22 | BOLT ACTION MOUNTS



MNT-914V2

### 4-Point Locking M14/M1A Scope Mount

- Precision Machined from Aircraft Aluminum with a Matte Black Finish
- 6" Length with 15 Picatinny Top Slots
- 4-Point Locking System Interfaces with the Stripper Clip Guide and Three Different Points of the Receiver Providing a Rock Solid Foundation



MNT-M1C

### M1 Carbine Mount Complete With 1" Rings

- Precision Machined from Aircraft Aluminum with a Matte Black Finish



MNT-R22SS26

### Scout Rail for Ruger 10/22 Rifles

- 11.7" Length with 26 Picatinny Top Slots
- Lightening Cuts for Weight Reduction
- Free Float Rail Does not Touch Barrel or Forend
- Compatible with Drilled and Tapped 10/22 Receivers



MTU030T22

MNT-22TOWL  
• Overseas Production



MTU030T22

### UTG PRO® Low Profile Scope Mount For Ruger 10/22 Rifles

- Precision Machined from Aircraft Aluminum with a Matte Black Anodized Finish
- 4.67" Length with 11 Picatinny Slots
- Compatible with Drilled and Tapped Receivers



MNT-RM700

### Scope Mount for Remington 700 Long Action Rifles

- Solid Steel Construction
- 6.3" Length with 6 Picatinny Top Slots
- Clearance Cut for Reliable Case Ejection



MNT-RM700S

### Scope Mount for Remington 700 Short Action Rifles

- Solid Steel Construction
- 5.47" Length with 6 Picatinny Top Slots
- Clearance Cut for Reliable Case Ejection



# MP5 | G3 | G36 MOUNTS

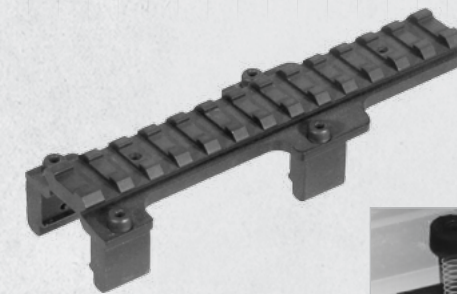

MNT-P669

### MP5 | G3 Low Profile Claw Mount

- Low Profile Top Rail with 13 Picatinny Slots
- Precision Machined from Aircraft Aluminum with a Matte Black Finish

Spring-Tensioned Claws and Receiver Set Screws for a Solid Installation

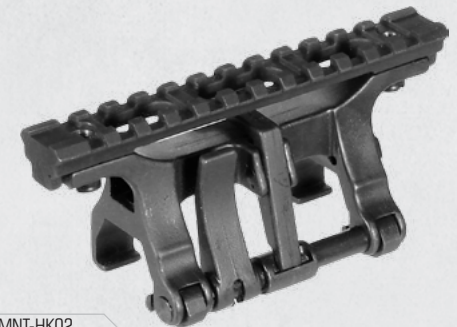
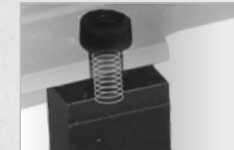

MNT-HK02

### MP5 | G3 Steel Claw Mount

- Complete with Detachable Steel Top Picatinny Rail and Secondary STANAG Mounting Base

STANAG Compatible

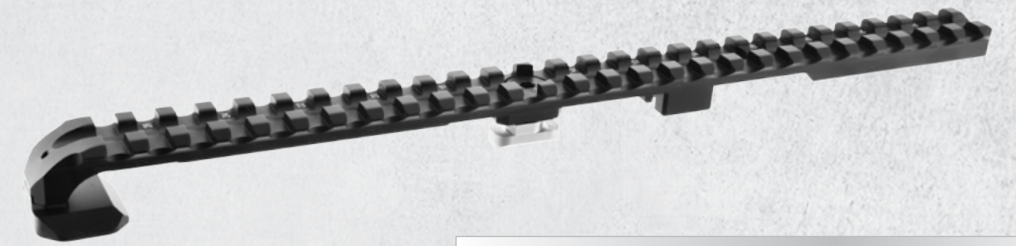
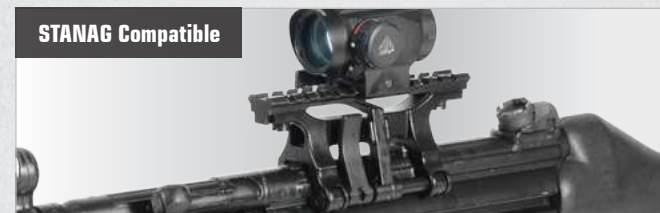

MNT-G3601

### G36 | SL8 Carry Handle Scope Mount

- Precision CNC Machined from Aircraft Aluminum with a Matte Black Finish
- 11.45" Length with 27 Picatinny Slots
- Lightweight and Low Profile, Securely Fits Into Standard G36/SL8 Carry Handle

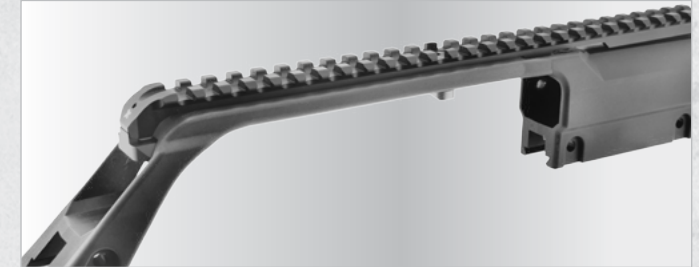

### G36 Picatinny Rail Sets

- Laser Engraved for Left, Right, and Bottom Designation and Accessory Placement

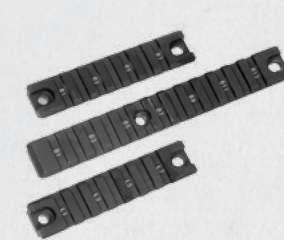

MNT-P503

### Set of 3

- One 6.08" Length Rail with 13 Picatinny Slots and Two 3.87" Length Rails with 7 Picatinny Slots



MNT-P505

### Set of 3

- Three 6.08" Length Rails with 13 Picatinny Slots



MNT-P501

### Set of 2

- Two 3.87" Length Rails with 7 Picatinny Slots



### Universal Rifle Barrel Mounts

- Precision Machined from Aircraft Aluminum with a Matte Black Finish
- Compatible Firearm Barrel Range: Diameter  $\varnothing$  .51" - .78"

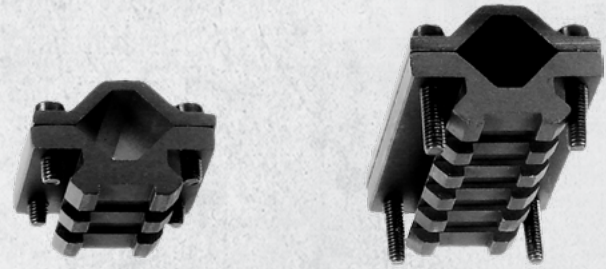

MNT-BR002S  
Single-Rail / 2 Slot

MNT-BR005S  
Single-Rail / 5 Slot



Model #	MNT-BR002S	MNT-BR005S	MNT-BR003XLS	MNT-BR003XL	MNT-BR005XL
Length / Width	1.2" / 1.4"	2.4" / 1.4"	1.6" / 1.7"	1.6" / 2.4"	2.4" / 2.4"
Top / Bottom / Left / Right Picatinny Slots	B: 2	B: 5	B: 3	B: 3 / L: 3 / R: 3	B: 5 / L: 5 / R: 5
Compatible Barrel Diameter	$\varnothing$ .51"-.78"	$\varnothing$ .51"-.78"	$\varnothing$ .75"-.1.10"	$\varnothing$ .75"-.1.10"	$\varnothing$ .75"-.1.10"
Compatible Flashlight/Laser Diameter	N/A	N/A	N/A	$\varnothing$ .75"-.1.10"	$\varnothing$ .75"-.1.10"
Net Weight	1.2 oz	2.0 oz	1.8 oz	4.4 oz	6.3 oz

### Universal Shotgun Barrel Mount

- Precision Machined from Aircraft Aluminum with a Matte Black Finish
- Compatible Firearm Barrel Range: Diameter  $\varnothing$  .75"-.1.10"
- Compatible Flashlight/Laser Range: Diameter  $\varnothing$  .75"-.1.10" (Tri-rail Models Only)

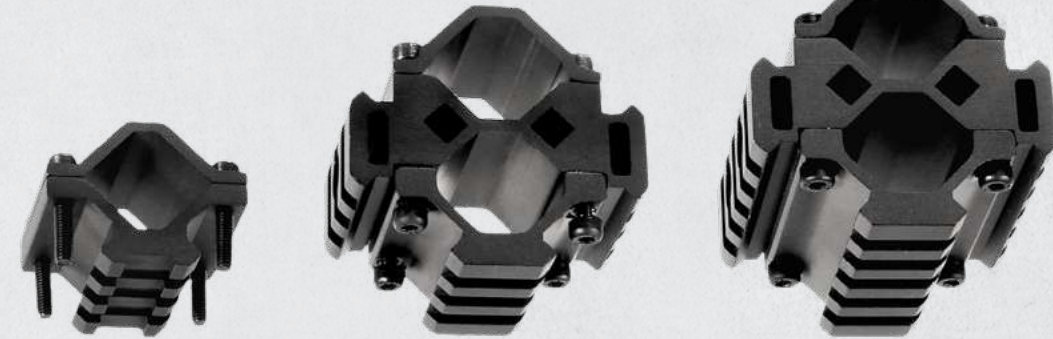

MNT-BR003XLS  
Single-Rail / 3 Slot

MNT-BR003XL  
Tri-Rail / 3 Slot  
• Flashlight/Laser Housing

MNT-BR005XL  
Tri-Rail / 5 Slot  
• Flashlight/Laser Housing

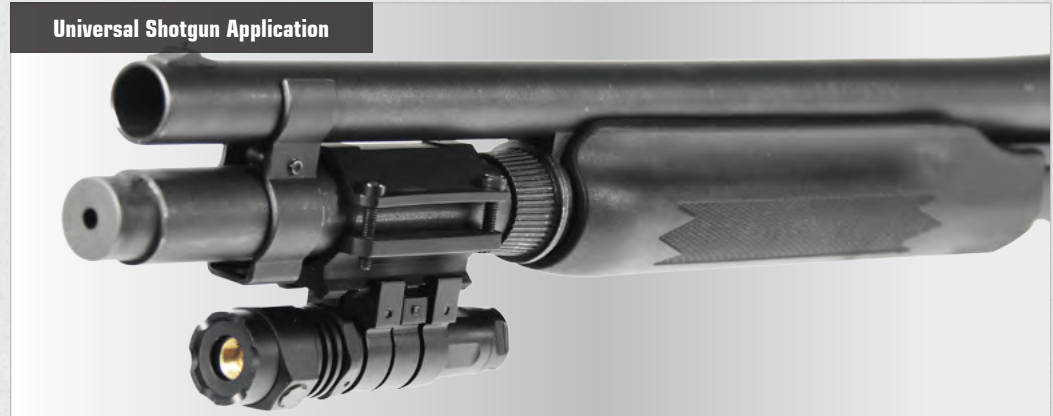

MNT-DTW145  
**Universal Dovetail To Picatinny Rail Adaptor**  
• Precision Machined from Aircraft Aluminum with a Matte Black Finish  
• Compatible with 9mm-11mm Dovetail Rails



Optimized Interface to Fit Undersized, Standard, and Oversized Rounded and Flat Receivers



Model #	MNT-DTW145	MNT-PMTOWL-A	MNT-DNT06
Length / Width	5.7" / 0.8"	3.9" / 0.9"	4.7" / 1.0"
Slope	N/A	N/A	1.1/120
Upward at 30 Yds	N/A	N/A	10"
Top Picatinny Slots	14	9	11
Net Weight	2.4 oz	2.2 oz	3.8 oz

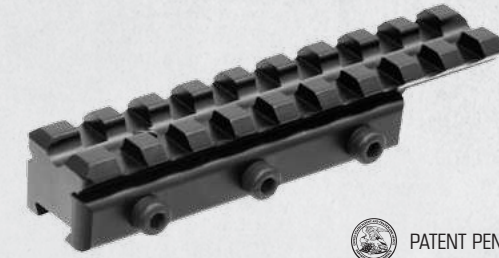

MNT-PMTOWL-A  
**Dovetail to Picatinny Adaptor Mount**  
• Precision Machined from Aircraft Aluminum with a Matte Black Finish  
• 3.94" Scalloped 9 Slot Picatinny Rail with 0.59" Saddle Height  
• Compatible with Flat Receivers Equipped with 9mm-11mm Dovetail Rails



Stop Pin to Prevent Forward and Rearward Movement from Birectional Recoil

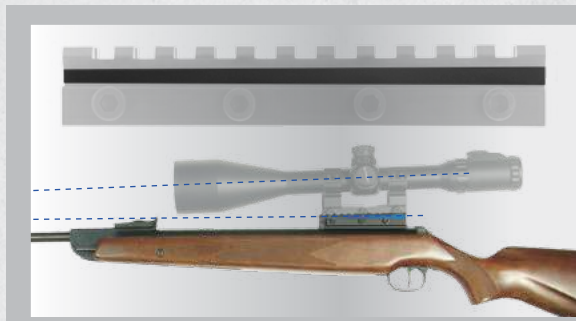

MNT-DNT06  
**Compensation Mount for T06 Tigger Equipped RWS Diana Air Rifles**  
• Precision Machined from Aircraft Aluminum with a Matte Black Finish  
• Compensation to Bring the POI (Point Of Impact) Up 10 Inches at 30 Yards



Dual Stop Pins to Prevent Forward and Rearward Movement from Birectional Recoil



**What's Barrel Droop ?**  
Barrel droop means that the barrel's bore is pointing downward in relation to the plane of the scope base. Compensating meant cranking up the elevation knob to bring the pellet back up to where the crosshairs are at or inserting a shim. UTG's compensation mount takes care of this for you, and is designed with special slopes to compensate for the barrel droop of RWS Diana air rifles.



## INTRODUCTION

Leapers UTG® has a well established reputation for making some of the finest bipods available. Tailored to provide a rock solid foundation to shoot from, the wide variety of our bipods means we have a solution for practically every firearms application and shooting discipline. Precision long range shooters, huntsman, tacticians, and everyday shooters whom all require the need for quality, strength, and innovation come to us first in their search for quality that perseveres. Check out the bipods and shooting stand section for the latest innovative products and designs such as our very first USA Made UTG PRO® Bipod, our new Over Bore Bipod, and Full Stability Bipod designed for big bore rifles, new for 2019.

## ABSOLUTE COMMITMENT TO QUALITY

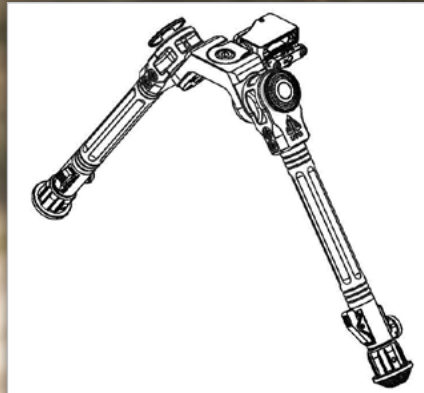

Design Concept to Finished Production

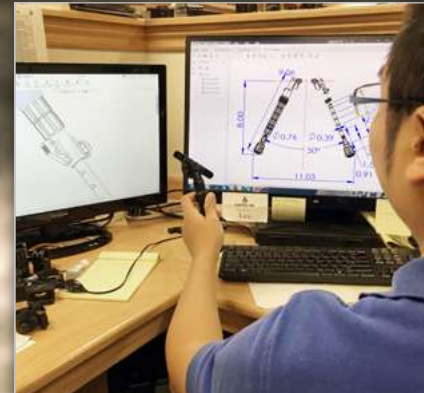

Intensive Engineering



Optimized World-class Machinery

**LEAPERS, INC.**  
**THE BEST NEVER REST**  
**LIFETIME WARRANTY**



Relentless Search for Excellence



Tightly Measured Tolerances



Rigorous Field Testing

## NEW AND MUST HAVE PRODUCTS FOR 2019

UTG PRO®  
 TBNR™  
 BIPODS



OVER BORE  
 BIPOD



BIG BORE FULL  
 STABILITY  
 BIPOD



GEN 2 D-GRIP®  
 QUICK DEPLOYABLE  
 BIPOD



RECON FLEX™  
 BIPODS



# UTG BIPODS & SHOOTING STAND



# A UTG PRO FIRST



## TBNR™ BIPODS



World Class Manufacturing

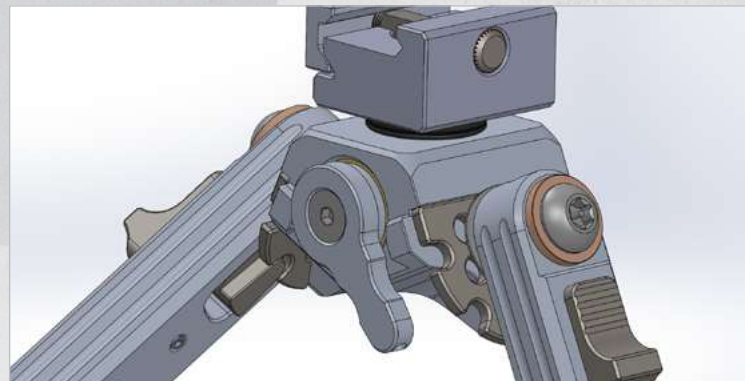

Michigan Designed, Engineered, and Manufactured

Designed and manufactured in our Michigan based UTG PRO® facility and headquarters, our first ever USA made bipod is the next tier in our commitment and dedication to provide our customers with improved product lines that are held to a higher degree of quality. Fully idealized, conceptualized, and proven here in the USA, our UTG PRO® bipod specifically addresses shooters, their situations, and their disciplines in its features, materials, functions, and quality.

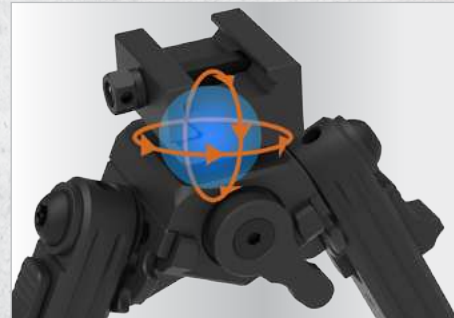

Tension Adjustable 360° Panning and 13° Tilt Forward, Rearward, Left, and Right



5 Position Bidirectional Folding with Steel-on-Steel Lockup

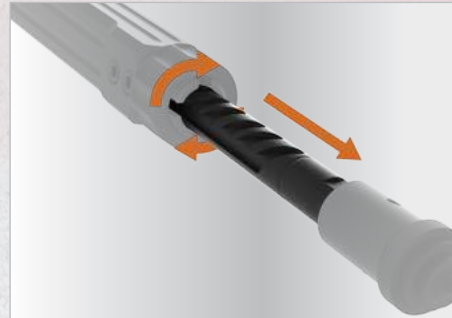

90° Throw and Keyed Legs for Height Adjustment



Tension Adjustable 13° Tilt Forward, Rearward, Left and Right

- MADE IN USA
- AIRCRAFT ALUMINUM
- STEEL
- 5 POSITION BIDIRECTIONAL FOLDING
- MIL-STD-1913 PICATINNY
- PATENT PENDING
- 360° PANNING

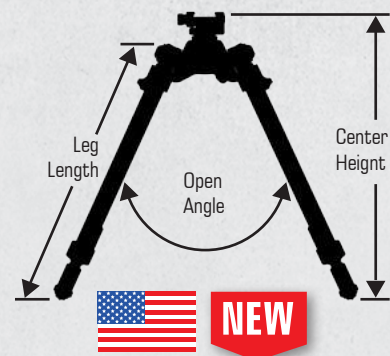

### UTG PRO® TBNR™ BIPODS

- Proudly Designed and Manufactured here in the USA
- Type III Class 2 Matte Black Hard Coat Anodize Finished CNC Machined Aluminum and Manganese Phosphate Treated Steel Construction
- 5 Position Bidirectional Folding with Steel-on-Steel Lockup
- Tension-adjustable 360° Panning
- Tension-adjustable 13° Tilt in the Forward, Rearward, Left, and Right Directions
- MIL-STD-1913 Picatinny Mounting Deck with Squared Steel Crossbolt
- Automatic Spring-loaded Leg Retraction
- 90° Throw and Keyed Legs Intuitively Manages Height Adjustability
- Ring Locks for Securing Height Adjustment in Place
- Replaceable Foot Pads and Compatible with Atlas Feet Interface

Model #	Center Height (Min - Max)	Leg Length (Min - Max)	Foot Pad	Weight	Panning	Tilting	Foldable Legs	Extendable Legs	Spring Loaded Quick Retraction	Swivel Stud Mount
TLUBP01	9.6" - 14.5"	9.5" - 15.4"	Steel/Removable	33oz	360°	13°	5 Position Bidirectional	7 Position	Leg Retraction	Sold Separately
TLUBP02	6" - 9"	5.9" - 10"	Steel/Removable	20oz	360°	13°	5 Position Bidirectional	4 Position	Leg Retraction	Sold Separately

MIL-STD-1913 Picatinny Mount with Square Steel Crossbolt

Automatic Spring-Loaded Leg Retraction

Open Angle: 50°

Ring Locks Secure Height Adjustment in Place

Type III Class 2 Hard Coat Anodize and Manganese Phosphate Finished

Replaceable Foot Pads Compatible with ATLAS Feet Interface

Ergonomic Posi-lock Release Easily Used With and Without Gloves

Aircraft Aluminum and Steel Construction

TLUBP02  
Center Height: 6" - 9"

TLUBP01  
Center Height: 9.6" - 14.5"

# UTG OVER BORE BIPOD

- AIRCRAFT ALUMINUM
- 5 POSITION BIDIRECTIONAL FOLDING
- MIL-STD-1913-PICATINNY
- OVER BORE MOUNTING
- QUICK DETACHABLE
- ADJUSTABLE HEIGHT

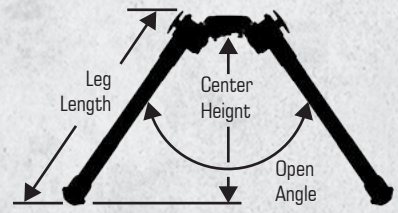

TL-BPOB01

## Over Bore Bipod

- Mounts to the Top Picatinny Rail of Handguards and with a Wider Open Angle for Improved Stability
- Aluminum and Steel Construction
- Quick Detachable System Allows Leg Configuration to Quickly Install and Remove from Mounting Base for Easier Storage
- 5 Position Bidirectional Folding
- Posi-lock Push Button with Larger Surface Area for Easier Use while Wearing Gloves
- Extendable and Lockable Legs with Rubberized Foot Pads for Traction
- Center Height: 7.36" - 11.02"

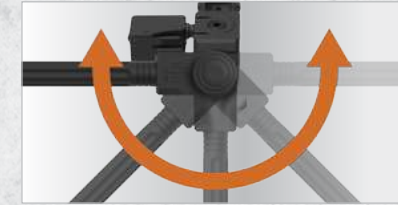

5 Position Bidirectional Folding

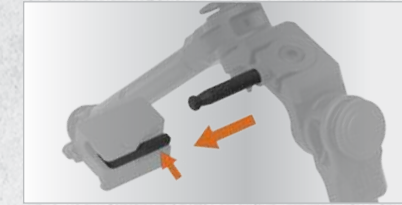

Bipod Body Detaches from Mounting Deck Via Quick Detach Lever Lock System

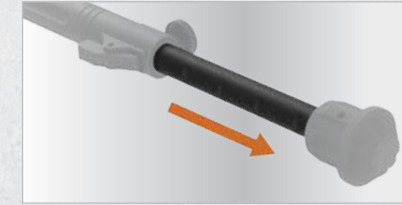

Precut and Flexible In-between Locking Positions



Square Shaped Integral Recoil Stops Prevent Forward and Rearward Movement Under Heavy Recoil



**NEW**

Open Angle: 70°

# UTG BIG BORE FULL STABILITY BIPOD

- AIRCRAFT ALUMINUM
- 5 POSITION BIDIRECTIONAL FOLDING
- MIL-STD-1913-PICATINNY
- BIG BORE APPLICATION
- PATENT PENDING

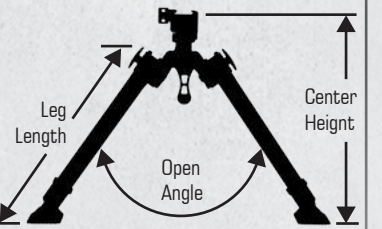

TL-BPFS01

## Big Bore Full Stability Bipod

- Designed from the Ground Up for Big Bore Rifle Applications
- Reinforced Aluminum and Steel Construction
- Panning and Tilting Lockable Via Lever
- 5 Position Bidirectional Folding
- Posi-lock Push Button with Larger Surface Area for Easier Use while Wearing Gloves
- Heavy Duty Serrated Foot Pads with Larger Surface Area for Traction and Stability
- Center Height: 9.6"-14.5"

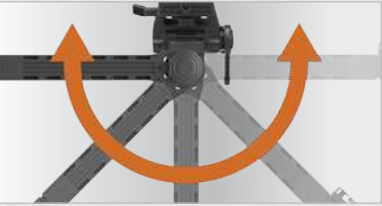

5 Position Bidirectional Folding



Lever Locked Panning



Tilting Lock Lever



Automatic Spring Loaded Leg Extension



Open Angle: 70°

Model #	Center Height (Min - Max)	Leg Length (Min - Max)	Foot Pad	Weight	Pan/Tilt	Foldable Legs	Extendable Legs	Spring Loaded	Swivel Mount
TL-BPOB01	7.36" - 11.02"	9.5" - 13.99"	Rubberized	29oz	22°/44°	5 Position Bidirectional	7 Position	N/A	N/A

Model #	Center Height (Min - Max)	Leg Length (Min - Max)	Foot Pad	Weight	Pan/Tilt	Foldable Legs	Extendable Legs	Spring Loaded	Swivel Mount
TL-BPFS01	9.6" - 14.5"	9.5" - 15.4"	Steel	36.1oz	35°/55°	5 Position Bidirectional	9 Position	Leg Extension	Sold Separately

- AIRCRAFT ALUMINUM
- 5 POSITION BIDIRECTIONAL FOLDING
- M-LOK KEYMOD & M-LOK®
- PATENT PENDING

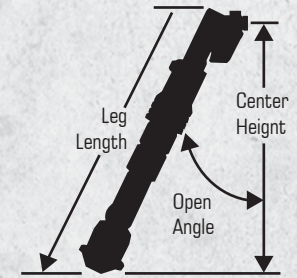

Ergonomic Spring Loaded Slide Locking Ring

5 Position Bidirectional Folding

### Recon Flex™ Bipods

- Directly Attaches to Handguard at the 3 and 9 O'clock Positions
- Ergonomic Spring Loaded Slide Locking Ring for Quick and Effortless Bipod Deployment
- Lightweight Aircraft Aluminum Construction with a Matte Black Finish
- Versatile Bidirectional Bipod Legs with 5 Posi-lock Positions for Use on Different Firearms with Varying Height Clearance and Mounting Real Estate
- Fully Adjustable Legs with Precut Extendable Lengths and Flexible In-between Positions Lockable via Thumb Wheel
- Equipped with Textured Nonslip Rubberized Foot Pads



Open Angle: 50°

Ergonomic Spring Loaded Slide Locking Ring

Aircraft Aluminum with a Matte Black Finish

Locking Thumb Wheel Secures Leg Height Adjustment

Textured Nonslip Rubberized Foot Pad

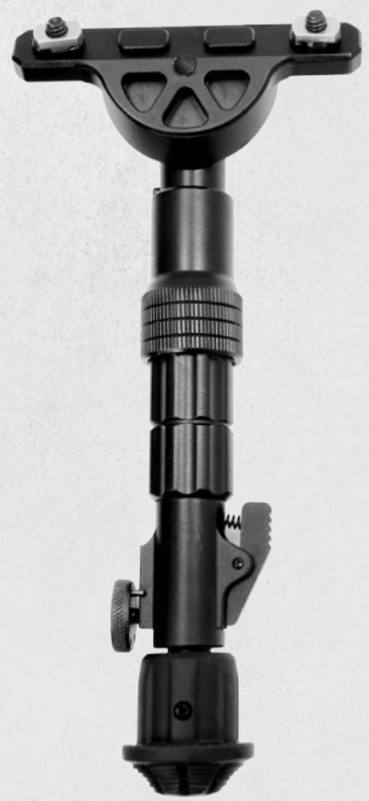
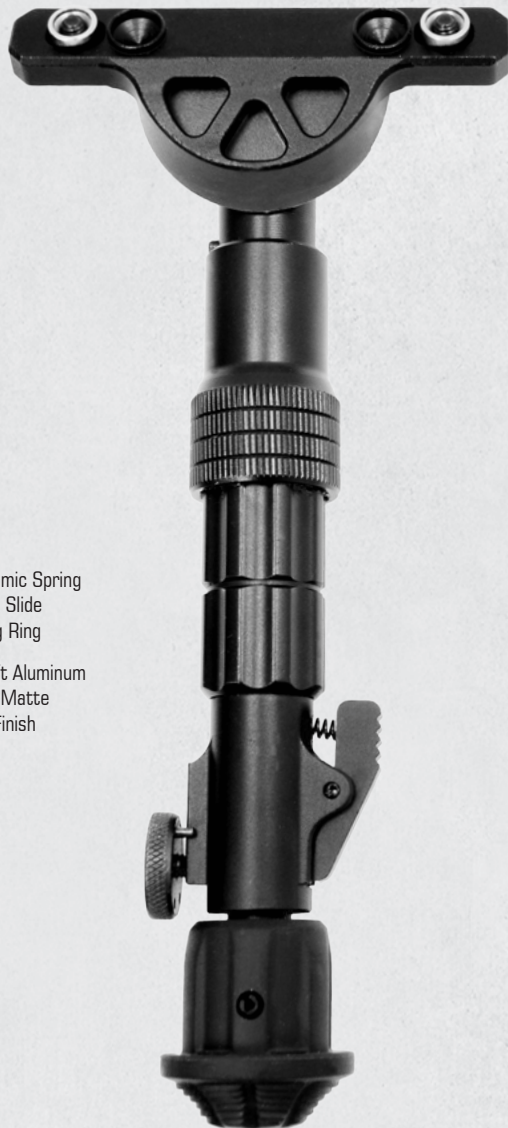

TL-BPDM01  
Center Height: 5.7" to 8.0"

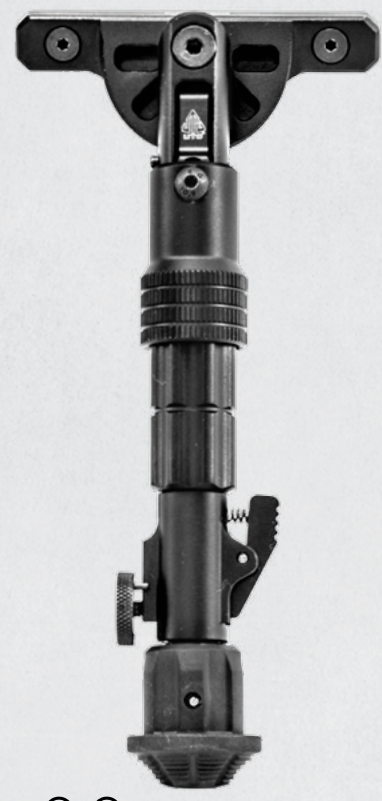

TL-BPK01  
Center Height: 5.7" to 8.0"

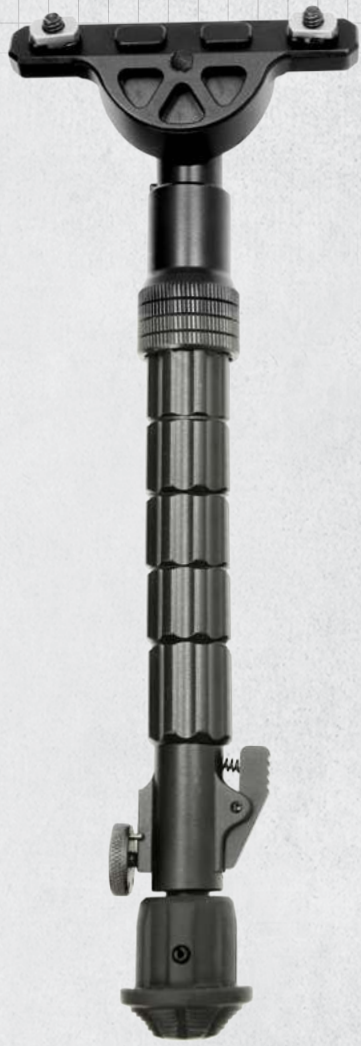

TL-BPDM02  
Center Height: 8"-11.8"

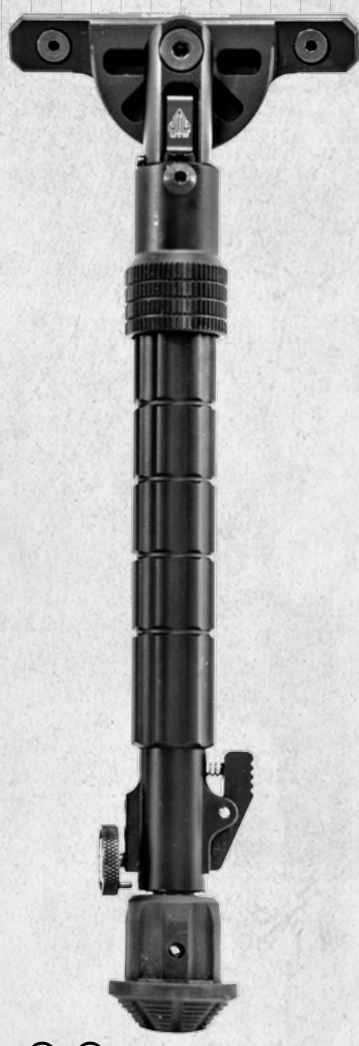

TL-BPK02  
Center Height: 8"-11.8"

Model #	Center Height (Min - Max)	Leg Length (Min - Max)	Foot Pad	Weight	Panning	Foldable Legs	Extendable Legs	Quick Retraction	Swivel Stud Mount
TL-BPK01	5.7" - 8.0"	6.3" - 9"	Rubberized	10.8oz / 2pcs	X	5 Position Bidirectional	✓	X	X
TL-BPDM01	5.7" - 8.0"	6.3" - 9"	Rubberized	10.8oz / 2pcs	X	5 Position Bidirectional	✓	X	X
TL-BPK02	8.0" - 11.8"	8.74" - 13.63"	Rubberized	11.8oz / 2pcs	X	5 Position Bidirectional	✓	X	X
TL-BPDM02	8.0" - 11.8"	8.74" - 13.63"	Rubberized	11.8oz / 2pcs	X	5 Position Bidirectional	✓	X	X



# RECON 360™ BIPOD SERIES

- AIRCRAFT ALUMINUM
- 5 POSITION BIDIRECTIONAL FOLDING
- MIL-STD-1913 PICATINNY
- US PAT. D758521
- US PAT. D758522
- 360° PANNING

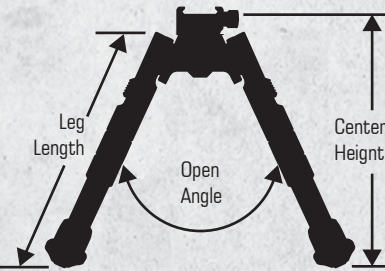

Tension Adjustable 360° Panning

- PARTS INCLUDED



Swivel Stud Kit (TL-BPAD1)

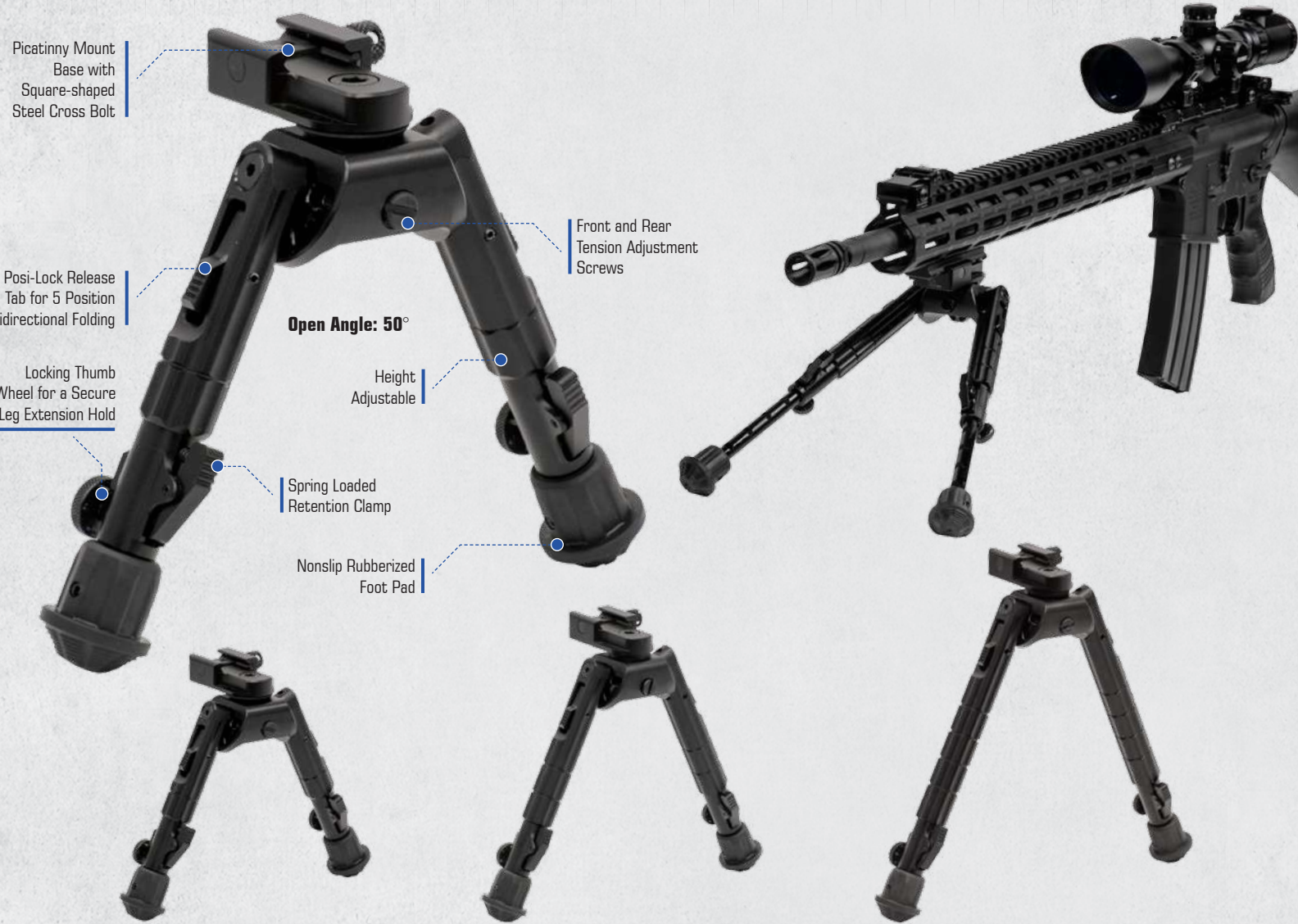

Picatinny Mount Base with Square-shaped Steel Cross Bolt

Posi-Lock Release Tab for 5 Position Bidirectional Folding

Locking Thumb Wheel for a Secure Leg Extension Hold

Open Angle: 50°

Spring Loaded Retention Clamp

Nonslip Rubberized Foot Pad

Front and Rear Tension Adjustment Screws

Height Adjustable

TL-BP02  
Center Height: 5.59" - 11.97"

TL-BP01  
Center Height: 6.69" - 9.12"

TL-BP03  
Center Height: 8.12" - 11.97"

Model #	Center Height (Min - Max)	Leg Length (Min - Max)	Foot Pad	Weight	Panning	Foldable Legs	Extendable Legs	Quick Retraction	Swivel Stud Mount
TL-BP01	6.69" - 9.12"	6.69" - 9.25"	Rubberized	13.3oz	360°	5 Position Bidirectional	✓	X	✓
TL-BP02	5.59" - 7"	5.21" - 6.77"	Rubberized	12oz	360°	5 Position Bidirectional	✓	X	✓
TL-BP03	8.12" - 11.97"	8.15" - 12.43"	Rubberized	15.3oz	360°	5 Position Bidirectional	✓	X	✓



# GEN 2 D-GRIP® QUICK RELEASE DEPLOYABLE BIPOD

- ALUMINUM + STEEL
- MIL-STD-1913 PICATINNY
- US PATENT: 8397421
- US PATENT: D727455
- US PATENT: 9,169,958
- EU REG: 002245522-0001
- EU REG: 002245522-0002



Quick Deployable Bipod and Foregrip



Ambidextrous Quick Release



Picatinny QD Lever Lock Mount

MNT-DG02Q

NEW

## UTG Gen 2 D-Grip®

- Durable Aircraft Aluminum and Steel Construction with a Matte Black Finish
- Contoured Foregrip with Nonslip and Heat-resistant Rubberized Inlays for a Secure and Repeatable Grip
- Ambidextrous Quick Release Deploys Foldable Impact-resistant Bipod Legs Instantly
- Picatinny Quick-detach Lever-lock Mount for Fast Installation and Removal
- 5.61" Foregrip Length with an 8.55" Center Height and 65° Open Angle when Bipod is Deployed



Aircraft Aluminum and Steel Construction with a Matte Black Finish

Ambidextrous Release

Ergonomically Contoured Grip

Nonslip Rubberized Grip Panels



Model #	Grip Height	Bipod Height	Weight	Foot Pad
MNT-DG02Q	5.61"	8.55"	12.15oz	Aluminum



# RUBBER ARMORED QD BIPOD

- ALUMINUM + STEEL
- MIL-STD-1913 PICATINNY
- 5 POSITION BIDIRECTIONAL FOLDING
- US PATENT: 8,397,421

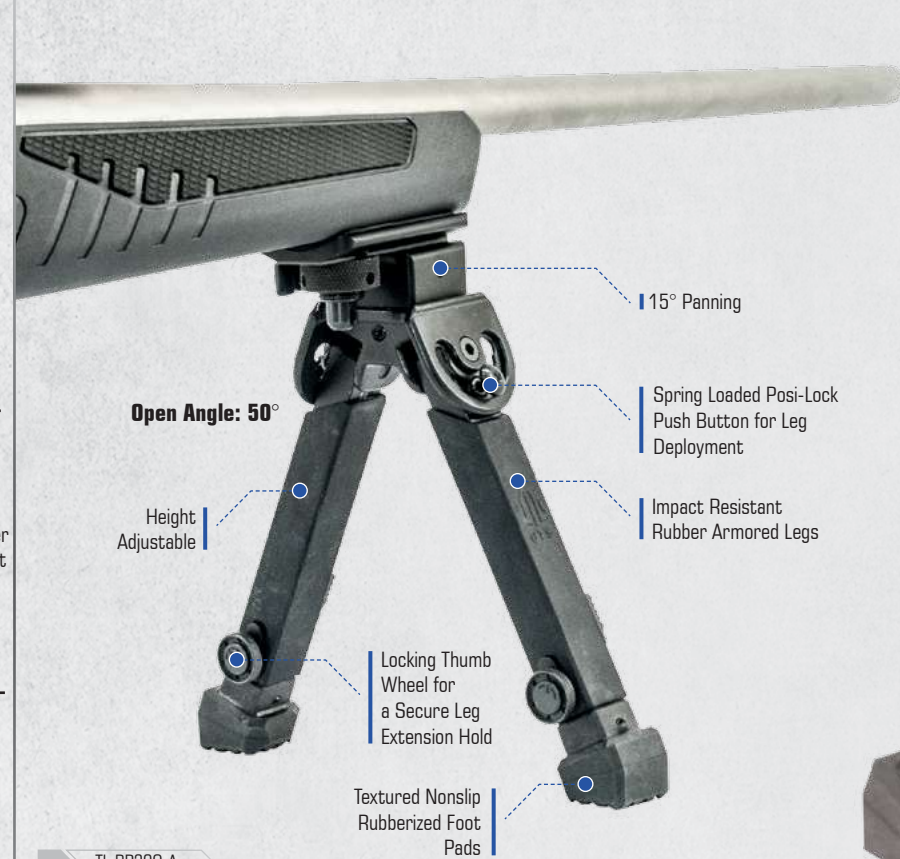
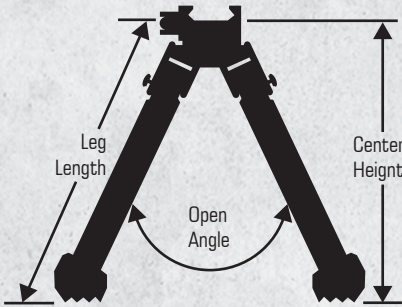

**TL-BP20Q-A**  
**Rubber Armored QD Bipod**  
Center Height: 6.0" - 8.5"



3 Position Bidirectional Folding Design

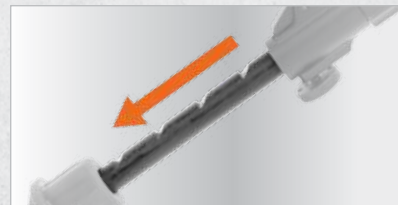

Precut and Flexible In-between Locking Positions



Picatinny Quick Detachable Lever Lock Mount

Model #	Center Height (Min - Max)	Leg Length (Min - Max)	Foot Pad	Weight	Panning	Foldable Legs	Extendable Legs	Quick Retraction	Swivel Stud Mount
TL-BP20Q-A	6.0" - 8.5"	5.5" - 8.0"	Rubberized	14oz	15°	3 Position Bidirectional	✓	X	✓



# SPRING LOADED BIPOD SERIES

- ALUMINUM + STEEL
- MIL-STD-1913 PICATINNY
- US PATENT: 8,397,421

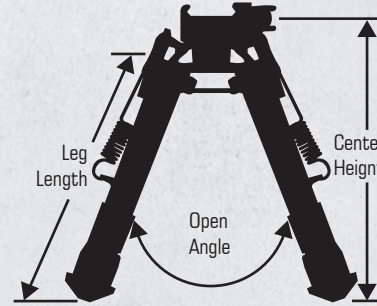

Swivel Stud Kit (TL-BPAD1)



**TL-BP98Q**  
**Medium Profile Super Duty QD Bipod**  
Center Height: 6.0" - 8.5"



**TL-BP99Q**  
**High Profile Super Duty QD Bipod**  
Center Height: 8.0" - 12.8"



**TL-BP78Q**  
**Medium Profile Tactical OP QD Bipod**  
Center Height: 5.9" - 7.3"



**TL-BP88Q**  
**High Profile Tactical OP QD Bipod**  
Center Height: 8.0" - 12.4"



**TL-BP78**  
**Medium Profile Tactical OP Bipod**  
Center Height: 6.1" - 7.9"



**TL-BP88**  
**High Profile Tactical OP Bipod**  
Center Height: 8.3" - 12.7"

Model #	Center Height (Min - Max)	Leg Length (Min - Max)	Foot Pad	Weight	Panning	Foldable Legs	Extendable Legs	Quick Retraction	Swivel Stud Mount	Bidirectional Folding
TL-BP98Q	6.0" - 8.5"	5.5" - 8"	Rubberized	13.8oz	15°	✓	✓	✓	✓	X
TL-BP99Q	8.0" - 12.8"	7.7" - 13.7"	Rubberized	17.4oz	15°	✓	✓	✓	✓	X
TL-BP78Q	5.9" - 7.3"	5.5" - 7.4"	Rubberized	5.8oz	15°	✓	✓	✓	✓	X
TL-BP88Q	8.0" - 12.4"	7.7" - 12.7"	Rubberized	12.8oz	15°	✓	✓	✓	✓	X
TL-BP78	6.1" - 7.9"	5.5" - 7.4"	Rubberized	11.5oz	15°	✓	✓	✓	✓	X
TL-BP88	8.3" - 12.7"	7.9" - 12.7"	Rubberized	13.3oz	15°	✓	✓	✓	✓	X





# SHOOTER'S BIPOD SERIES

- AIRCRAFT ALUMINUM
- MIL-STD-1913 PICATINNY
- US PATENT: 8,397,421

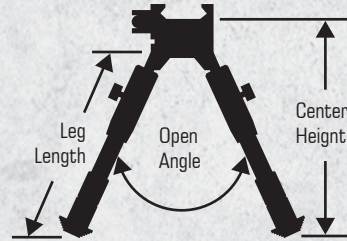

- PARTS INCLUDED



Model #	Center Height (Min - Max)	Leg Length (Min - Max)	Foot Pad	Weight	Panning	Foldable Legs	Extendable Legs	Quick Extension	Swivel Stud Mount
TL-BP28SQ	6.2" - 6.7"	5.25" - 5.75"	Rubberized	8.1oz	15°	✓	✓	✓	✓
TL-BP28S	6.2" - 6.7"	5.25" - 5.75"	Rubberized	8.1oz	15°	✓	✓	✓	✓
TL-BP28ST	6.0" - 7.0"	5.3" - 6.3"	Steel	8.3oz	15°	✓	✓	✓	✓
TL-BP69SQ	8.7" - 10.6"	8" - 9.75"	Rubberized	11.1oz	15°	✓	✓	✓	✓
TL-BP69S	8.7" - 10.6"	8" - 9.75"	Rubberized	11.3oz	15°	✓	✓	✓	✓
TL-BP69ST	8.2" - 10.3"	7.75" - 9.75"	Steel	10.9oz	15°	✓	✓	✓	✓



**TL-BP28SQ**  
**New Gen Medium Profile QD Shooter's Bipod**  
 • Center Height: 6.2" - 6.7"  
 • Nonslip Rubberized Foot Pads



**TL-BP28S**  
**Medium Profile Shooter's SWAT Bipod**  
 • Center Height: 6.2" - 6.7"  
 • Nonslip Rubberized Foot Pads



**TL-BP28ST**  
**Medium Profile Shooter's SWAT Bipod**  
 • Center Height: 5.8" - 6.8"  
 • Steel Foot Pads



**TL-BP69SQ**  
**High Profile QD Shooter's Bipod**  
 • Center Height: 8.7" - 10.6"  
 • Nonslip Rubberized Foot Pads



**TL-BP69S**  
**High Profile Shooter's Bipod**  
 • Center Height: 8.7" - 10.6"  
 • Nonslip Rubberized Foot Pads



**TL-BP69ST**  
**High Profile Shooter's Bipod**  
 • Center Height: 8.7" - 10.6"  
 • Steel Foot Pads



# BARREL CLAMP BIPODS & SHOOTING STAND



**TL-BP18S-A**  
**Medium Profile Reinforced Clamp-on Bipod**  
 • Center Height: 6.2" - 6.7"  
 • Fits Barrel Diameters 0.43" - 0.75" (11mm - 19mm)  
 • Nonslip Rubberized Foot Pads



**TL-BP08S-A**  
**High Profile Reinforced Clamp-on Bipod**  
 • Center Height: 8.7" - 10.2"  
 • Fits Barrel Diameters 0.43" - 0.75" (11mm - 19mm)  
 • Nonslip Rubberized Foot Pads



**TL-BP08ST-A**  
**High Profile Clamp-on Bipod**  
 • Center Height: 8.7" - 10.2"  
 • Fits Barrel Diameters 0.43" - 0.75" (11mm - 19mm)  
 • Steel Foot Pads



**TL-BP70**  
**Polymer Clamp-on Bipod**  
 • Center Height: 10" - 11"  
 • Clamps directly around most barrels  
 • Folds together to be easily stowed away

**TL-MP150Q**  
**Monopod**  
 • Center Height: 20.5" - 58.75"  
 • Quick Release Spring-loaded Leg Extension  
 • Locking Thumb Wheels for Secure Leg Extension Hold



Rubber Armored Metal V-Rest  
 Camera Mount Adaptor



Model #	Center Height (Min - Max)	Leg Length (Min - Max)	Foot Pad	Weight	Panning	Foldable Legs	Extendable Legs	Quick Extension	Swivel Stud Mount	Bidirectional Folding
TL-BP08S-A	8.7" - 10.2"	8" - 9.7"	Rubberized	10.3oz	X	✓	✓	✓	X	X
TL-BP08ST-A	9" - 11"	7.5" - 10"	Steel	13oz	X	✓	✓	✓	X	X
TL-BP18S-A	6.2" - 6.7"	5.2" - 5.7"	Rubberized	10.3oz	X	✓	✓	✓	X	X
TL-BP70	10"	11"	Polymer	6.4oz	X	X	X	✓	X	X
TL-MP150Q	20.5" - 58.75"	20.5" - 58.75"	Rubberized	24.8oz	X	X	✓	✓	X	X

## INTRODUCTION

Low light situations and environments introduce an added level of difficulty to target and threat identification. Utilizing firearms safely and effectively in low light requires disciplined training and benefits from ergonomic solutions that are deliberately quick to manipulate. Leapers UTC® understands that both flashlights and lasers are taught through varied training disciplines and certainly are not a one size fits all type of deal. This is primarily the reason why many of our products come complete right out of the box with the majority being configurable for handheld or firearm mounted operation. Our flashlights come in a variety of different lumen outputs to suit different individual needs and environmental requirements whether indoor or outdoor with the majority providing both momentary/constant on/off activation. Our lasers are internally designed using the same and proven True Strength™ Platform found in our premium line of optics for reliable and repeatable zero retention and precise windage and elevation adjustment. Check out the flashlights and lasers section for the latest innovative products and designs such as our new for 2019 Everyday Carry Flashlight, Polymer Grip Light, and new light and laser products dedicated for pistols.

**LEAPERS, INC.**  
**THE BEST NEVER REST**  
**LIFETIME WARRANTY**

## ABSOLUTE COMMITMENT TO QUALITY



Submersion Testing



Torture Testing



Luminous Flux Testing



Current & Run Time Evaluation and Spectrum Radiometer Analysis

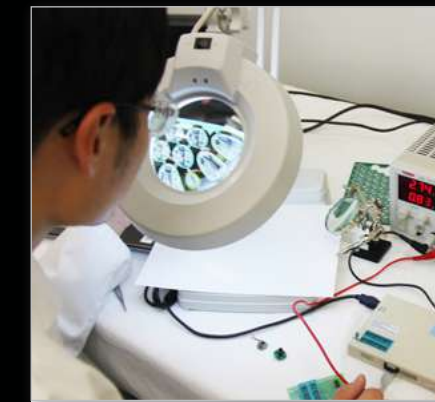

Meticulous Quality Control and Detailed Inspection

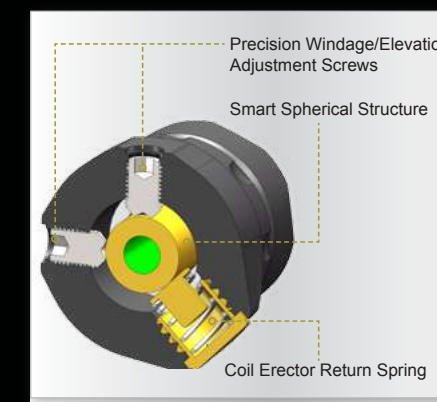

Precision and Recoil Proof Components

### NEW AND MUST HAVE PRODUCTS FOR 2019

POLYMER 400 LUMEN GRIP LIGHT

NEW



400 LUMEN COMPACT PISTOL LIGHT

NEW



400 LUMEN EVERYDAY CARRY FLASHLIGHT

NEW



COMPACT GREEN LASER SIGHT

NEW



# FLASHLIGHTS & LASERS

	VANQUISH SERIES		PISTOL SERIES			GRIP LIGHTS		
								
<b>PAGE RANGE</b>	p. 121	p. 121	p. 120	p. 120	p. 120	p. 118	p. 119	p. 119
<b>AVAILABLE MODELS</b>	LT-EL700	LT-EL700HL	LT-ELP120R	LT-ELP123R-A	LT-ELP223Q-A	MT-EL223GX	MNT-EL228GPQ-A	LT-EL223HL-A
<b>IRB TYPE (INTEGRATED REFLECTOR &amp; BULB)</b>	37mm IRB / CREE LED	37mm IRB / CREE LED	20mm IRB / CREE LED	24mm IRB / CREE LED	23mm IRB / CREE LED	23mm IRB / CREE LED	23mm IRB / CREE LED	24mm IRB / CREE LED
<b>ILLUMINATION PERFORMANCE</b>	700 Lumen	700 Lumen	400 Lumen			400 Lumen		
<b>HIGHLIGHTS</b>	LED lights, an excellent choice for outdoor sports and activities while being equally useful for law enforcement and other emergency services personnel. Sturdy construction and a reliable LED make performing in harsh conditions and environments less of a challenge while the various included mounting options add to the versatility of these flashlights.		Equipped with either a Picatinny QD lever lock or integral low profile mount, our series of pistol lights are quick to install and remove making them ideal for home defense, law enforcement, and more. Some models feature our removable Posi-lock tabs, providing additional compatibility across a wider variety of pistols.			When looking for less weight and bulk hanging off your long guns, incorporating the features of a foregrip and weapon light into simply one unit is an ideal alternative to running both separately. Featuring either a Picatinny quick detachable lever lock or low profile mount our grip lights provide, simultaneously, the benefits of on-target illumination at the push of a button and the retention of a vertical foregrip. We also offer a handheld standalone designed with self-defense in mind and featuring our lumen adjustable L.I.B.R.E. technology.		
<b>MOUNTING METHOD</b>	Angled Offset Picatinny Ring Mount	Handheld, No Mount Included	Picatinny Quick Detach Lever Lock or Low Profile Mount			Picatinny Quick Detach Lever Lock or Low Profile Mount (Firearm Grip Light Only)		

	MULTI-PURPOSE SERIES					
						
<b>PAGE RANGE</b>	p. 122	p. 122	p. 122	p. 122	p. 123	p. 123
<b>AVAILABLE MODELS</b>	LT-ELEDC01	LT-EL228Q-A	LT-EL268-A	LT-EL202-A	LT-EL338Q	LT-EL138
<b>IRB TYPE</b>	20mm IRB / CREE LED	27mm IRB / CREE LED		23mm IRB / CREE LED	37mm IRB / CREE LED	
<b>ILLUMINATION PERFORMANCE</b>	400 Lumen				200 Lumen	
<b>HIGHLIGHTS</b>	Multi-purpose flashlights suitable for a range of different applications, activities, job descriptions, and lifestyles. Whether looking to supplement your home or self-defense, hunting or outdoor outings, or to aid in your law enforcement and emergency services, you will find our 400 and 200 lumen multi-purpose flashlights the right flashlight for the task at hand.					
<b>MOUNTING METHOD</b>	Handheld, No Mount Included	Interchangeable Handheld and Picatinny Quick Detach Lever Lock Mount Bodies		Slide-on Picatinny Ring Mount	Picatinny Quick Detach Lever Lock	Angled Offset Picatinny Mount

	BULL DOT® LASERS		GREEN LASERS		RED LASERS		FLASHLIGHT/LASER COMBOS		
									
<b>PAGE RANGE</b>	p. 124		p. 124	p. 124	p. 125	p. 125	p. 126	p. 126	p. 126
<b>AVAILABLE MODELS</b>	SCP-LS289S		SCP-LS279	SCP-LS279S-A	SCP-LS268	SCP-LS200	LT-ELP39Q-A	LT-ELP38Q-A	LT-ELP28R
<b>IRB TYPE (INTEGRATED REFLECTOR &amp; BULB)</b>	Class 3R Conical Green Laser		Class 3R Green Laser		Class 3R Red Laser		23 mm IRB / CREE LED & Class 3R Green Laser	23 mm IRB / CREE LED & Class 3R Red Laser	16 mm IRB / CREE LED & Class 3R Red Laser
<b>ILLUMINATION + BEAM PERFORMANCE</b>	2.0-4.5 mW Output		2.0-4.8 mW Output		2.5-3.1 mW Output	2.0-4.0 mW Output	400 Lumen & 2.0-4.8 mW Output	400 Lumen & 2.5-3.1 mW Output	120 Lumen & 2.5-3.1 mW Output
<b>HIGHLIGHTS</b>	Laser with integral Picatinny mounting base and compact design. An exceptional assisted aiming device designed for fast target acquisition and transitioning, the Bull Dot® utilizes a conical laser dot diode that expands as the distance to target increases.		The preferred choice for superior laser visibility, our green lasers cater to the customization and added effectiveness of various firearms makes and models with an option also available and specifically dedicated for Picatinny rail equipped pistols.		Our red lasers available in multiple sizes, cater to the customization of various firearm makes and models. As with all of our lasers, they are built on the same True Strength™ platform. More commonly available in smaller sizes, red lasers offer a great balance between cost, size, and effectiveness.		Taking the positive attributes of both assisted aiming and illumination, flashlight/laser combos are an ideal alternative to running the two separately. Majority of models feature both our Genuine Lumen Promise and our proven True Strength™ platform making for a formidable add-on to any long gun.		
<b>MOUNTING METHOD</b>	Low Profile Mount		Slide-on Picatinny Ring Mount	Picatinny Low Profile Mount	Slide-on Picatinny Ring Mount	Picatinny Low Profile Mount	Picatinny Quick Detach Lever Lock		Picatinny Low Profile Mount

ITEM # ACCESSORY	FLASHLIGHT													LASER					FLASHLIGHT/LASER COMBOS				
	LT-EL700	LT-EL700HL	LT-ELP120R	LT-ELP123R-A	LT-ELP223Q-A	MT-EL223GX	MNTEL228GPQ	LT-EL223HL-A	LT-ELEDC01	LT-EL228Q-A	LT-EL268-A	LT-EL202R-A	LT-EL338Q	LT-EL138	SCP-LS289S	SCP-LS279	SCP-LS279S-A	SCP-LS268	SCP-LS200	LT-ELP39Q-A	LT-ELP38Q-A	LT-ELP28R	
<b>PRESSURE SWITCH TL-PSLS268</b>																		✓					
<b>PRESSURE SWITCH TL-PSTL099-A</b>										✓	✓	✓	✓								✓	✓	
<b>RING MOUNT RG-FL138</b>	✓	✓						✓		✓													
<b>RING MOUNT RG-FL27KC</b>	✓	✓						✓	✓	✓	✓		✓	✓									
<b>RING MOUNT RG-FL27MC</b>	✓	✓						✓	✓	✓			✓	✓									
<b>RING MOUNT RG-FL860</b>	✓	✓						✓		✓													

✓=Compatible Item

# UTG POLYMER GRIP LIGHT

- IMPACT RESISTANT POLYMER
- MIL-STD-1913 PICATINNY
- IPX7 WATERPROOF
- L.I.B.R.E TECHNOLOGY
- STROBE CAPABLE
- ADJUSTABLE BRIGHTNESS

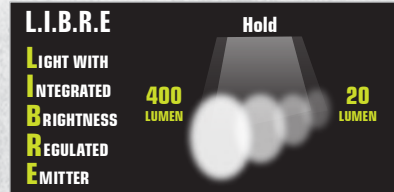

Sophisticated Circuit Board Technology Dims from 400 Lumen to 20 Lumens in a Matter of Seconds

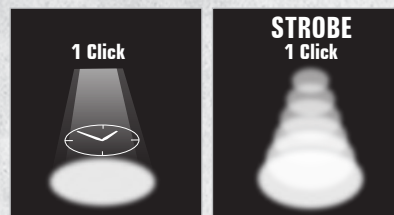

Momentary/Constant On/Off

Ambidextrous Constant Strobe

Impact Resistant Polymer



MT-EL223GX

## Polymer Grip Light

**NEW**



L.I.B.R.E. Lumen Control Pad

Steel Picatinny Crossbar

IPX7 Waterproof Rated

Model #	Lumen Output	Firearm Mount	Length/Width/Height	Weight with Battery	Bulb Type	Focus	Battery Type & Quantity	Battery Operating Time	Pressure Switch
MT-EL223GX	High-400 Lumen Low-20 Lumen	Low Profile Picatinny	2.13"/1.38"/4.09" 54.1mm/35.1mm/103.9mm	4.9oz (140g)	23mm IRB with CREE LED	Wide Angled Flood	CR123A x 2	High-3 hrs Low-24 hrs	N/A

# UTG ALUMINUM GRIP LIGHTS



- IPX7 WATERPROOF
- STROBE CAPABLE
- ADJUSTABLE BRIGHTNESS



LT-EL223HL-A

## 400 Lumen Everyday Defense LED L-light

- Rear Facing Lumen Control Pad for Adjusting Brightness Intensity, Strobe Activation, and Returning to the Last Used Brightness Setting
- IPX7 Waterproof Rated



Law Enforcement

Everyday Carry

Utility

Model #	Lumen Output	Firearm Mount	Length/Width/Height	Weight with Battery	Bulb Type	Focus	Battery Type & Quantity	Battery Operating Time	Pressure Switch
MNT-EL228GPQ-A	400 Lumen	Picatinny QD Lever Lock Mount	2.80"/1.77"/5.34" 71mm/45.8mm/135.7mm	12oz (340.2g)	23mm IRB with CREE LED	Wide Angled Flood	CR123A x 2	3 hrs	N/A
LT-EL223HL-A	High-400 Lumen Low-20 Lumen	N/A	2.68"/1.06"/3.88" 68mm/27mm/98.5mm	4.9oz (140g)	24mm IRB with CREE LED	Wide Angled Flood	CR123A x 2	High-3 hrs Low-24 hrs	N/A



Dims from 400 Lumen to 20 Lumens in a Matter of Seconds

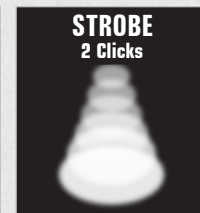

Press the Main Power Button to activate or deactivate the flashlight. (Lumen Control Pad only works when the flashlight is already on.)



Once the flashlight is on, the Lumen Control Pad can be used to dim down the flashlight, use strobe, and to turn the power on/off and save the last lumen setting used.



US PATENT: 8,397,421

MIL-STD-1913 PICATINNY

MNT-EL228GPQ-A

## New Gen 400 Lumen Grip Light with QD Mounting Base

- Preset Wide Angled Flood Focus Beam for Superior Short and Medium Range Performance
- 3 Hour Runtime
- Aircraft Aluminum Body, Anodized for Wear Resistance
- Momentary/Constant On/Off Push Button



2 in 1 Foregrip & LED Flashlight

Knurled Grip Surface

Quick Detach Lever Lock Mount

**NEW**

LT-ELP120R

**400 Lumen QD Sub-compact LED Pistol Light**

- Ambidextrous Toggle Switch Operation with Momentary/Constant On/Off
- Fits Flush on Compact Pistols
- IPX7 Waterproof Rated
- Precision CNC Machined Aircraft Aluminum

 Best in Class  
400 Lumen CREE LED

Low Profile Mount

 Ambidextrous Momentary/  
Constant On/Off Toggle  
Switch

LT-ELP123R-A

**400 Lumen Compact Pistol Light**

- Ambidextrous Toggle Switch Operation with Momentary/Constant On/Off
- Removable Posi-lock tabs for ICompatibility Across a Large Variety of Pistols



400 Lumen CREE LED

 Picatinny Low Profile  
Mount

 Ambidextrous Momentary/  
Constant On/Off Toggle  
Switch

LT-ELP223Q-A

**400 Lumen QD Pistol Light**

- Ambidextrous On/Off Tail Cap with Momentary/Constant On/Off Operation
- Removable Centered and Offset Posi-lock tabs for Increased Compatibility Across a Larger Variety of Pistols
- 3 Hour Run Time



400 Lumen CREE LED

 Ambidextrous  
Momentary/Constant  
On/Off Toggle Switch

 Quick Detach Lever Lock  
Mount

 US PATENT: 8,397,421

-  AIRCRAFT ALUMINUM
-  MIL-STD-1913 PICATINNY
-  HANDHELD
-  L.I.B.R.E. TECHNOLOGY
-  IPX7 WATERPROOF

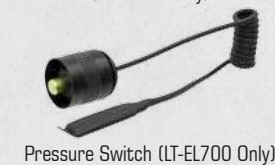
**PARTS INCLUDED**

HANDHELD LT-EL700HL

**Vanquish 700 Flashlight**

- Brightness Regulator with Memory Function Scales from 700 to 20 Lumens
- Strobe Mode Activated via Lumen Control Pad
- Momentary/Constant On/Off Push Button End Cap

MOUNTED INCLUDED LT-EL700



Lumen Control Pad

 Momentary/Constant  
On/Off Tail Cap

**L.I.B.R.E**
**L**IGHT WITH  
**I**NTEGRATED  
**B**RIGHTNESS  
**R**EGULATED  
**E**MITTER

**700**  
LUMEN

**20**  
LUMEN

Hold

Dims from 700 Lumen to 20 Lumen within a Matter of Seconds

**MEMORY**  
1 Click

Programmable Brightness Intensity

**STROBE**  
2 Clicks

Rapid Strobe Model

Model #	Lumen Output	Firearm Mount	Length/Width/Height	Weight with Battery	Bulb Type	Focus	Battery Type & Quantity	Battery Operating Time	Pressure Switch
LT-ELP120R	400 Lumen	Picatinny Low Profile Mount	2.98"/1.12"/1.13" 75.8mm/28.5mm/28.7mm	2.6oz (73g)	20mm IRB with CREE LED	Preset Flood	CR2 x 1	1 hr	N/A
LT-EL123R-A	400 Lumen	Picatinny Low Profile Mount	3.11"/1.31"/1.50" 79mm/33.3mm/38mm	3.5oz (100.2g)	24mm IRB with CREE LED	Preset Flood	CR2 x 1	1 hr	N/A
LT-EL223Q-A	400 Lumen	Picatinny QD Lever Lock Mount	3.57"/2.07"/1.63" 90.8mm/52.6mm/41.5mm	5.7oz (161.6g)	23mm IRB with CREE LED	Preset Flood	CR123A x 2	3 hrs	N/A

Model #	Lumen Output	Firearm Mount	Length/Width	Weight with Battery	Bulb Type	Focus	Battery Type & Quantity	Battery Operating Time	Pressure Switch
LT-EL700	High-700 Lumen Low-20 Lumen	Angled Offset Picatinny Ring Mount	6.7"/1.81" 170mm/46mm	8.2oz (233.9g)	37mm IRB with CREE LED	Hybrid Beam with Large Spill Area & Intense Long Range Hotspot	CR123A x 2 (Also compatible with 18650 rechargeable battery)	High-3 hrs Low-24 hrs	Yes
LT-EL700HL	High-700 Lumen Low-20 Lumen	N/A	6.7"/1.81" 170mm/46mm	8.2oz (233.9g)	37mm IRB with CREE LED		CR123A x 2 (Also compatible with 18650 rechargeable battery)	High-3 hrs Low-24 hrs	N/A



# MULTI-PURPOSE FLASHLIGHTS



# MULTI-PURPOSE FLASHLIGHTS

FLASHLIGHTS AND LASERS



LT-ELEDC01

### 400 Lumen Everyday Carry Flashlight

- Reversible Pocket Clip
- Tail Cap Operation: Momentary/Constant On/Off, Strobe, and S.O.S.
- IPX7 Waterproof Rated

IPX7 WATERPROOF



Serrated Strike Face



Recessed Push Button Tail Cap



LT-EL228Q-A

### 400 Lumen Interchangeable LED Light

- 3 Hour Run Time
- Triple Activation System Featuring Twist on, Push Button, and Remote Pressure Switch Operation



US PATENT: 8,397,421



Interchangeable Picatinny Quick Detach Lever Lock Mount Body



LT-EL268-A

### 400 Lumen Multi-purpose LED Light

- 3 Hour Run Time
- Triple Activation System Featuring Twist on, Push Button, and Remote Pressure Switch Operation



Slide-on Picatinny Ring Mount



LT-EL202R-A

### 400 Lumen QD LED Weapon Light

- Picatinny Quick Detach Lever Lock Mount for Quick Installation and Removal
- Triple Activation System Featuring Twist on, Push Button and Remote Pressure Switch Operation



US PATENT: 8,397,421



LT-EL338Q

### 200 Lumen Interchangeable LED Light

- Triple Activation System Featuring Twist on, Push Button and Remote Pressure Switch Operation
- Integrated Reflector and Bulb with Instant Spot Focus



US PATENT: 8,397,421



Interchangeable Picatinny Quick Detach Lever Lock Mount



Serrated Strike Face



Rolling Stop Shoulder



LT-EL138

### COP 200 Lumen LED Light

- High Power-to-Size Illumination Ratio with Flood Focus
- Momentary/Constant On/Off Push Button or Momentary On/off Remote Pressure Switch Operation



Angled Offset Picatinny Ring Mount



Serrated Strike Face



Rolling Stop Shoulder



FLASHLIGHTS AND LASERS

MULTI-PURPOSE 200 LUMEN FLASHLIGHTS

MULTI-PURPOSE FLASHLIGHTS

Model #	Lumen Output	Firearm Mount	Length/Width/Height	Weight with Battery	Bulb Type	Focus	Battery Type & Quantity	Battery Operating Time	Pressure Switch
LT-ELEDC01	1. 400 Lumen 2. 200 Lumen 3. 20 Lumen	N/A	4.72"/1.10" 120mm/28mm	7oz (200g)	20mm IRB with CREE LED	Preset Flood	CR123A x 2 (Also Compatible w/ 18650 Rechargeable Battery)	50 mins (400 Lumens) 2 Hrs (200 Lumens) 24 Hrs (20 Lumens)	N/A
LT-EL228Q-A	400 Lumen	Interchangeable Picatinny QD Lever Lock	5.35"/1.37"/1.37" 136mm/34.7mm/34.7mm	6.6oz (188g)	27mm IRB with CREE LED	Preset Flood	CR123A x 2	3 hrs	Yes
LT-EL268-A	400 Lumen	Slide-on Picatinny Ring Mount	5.28"/1.55"/1.55" 134mm/39.3mm/39.3mm	5.7oz (162g)	27mm IRB with CREE LED	Preset Flood	CR123A x 2	3 hrs	Yes
LT-EL202R-A	400 Lumen	Interchangeable Picatinny QD Lever Lock	4.31"/1.71"/1.73" 109.5mm/43.4mm/44mm	9.8oz (160g)	23mm IRB with CREE LED	Preset Flood	CR2 x 2	2 hrs	Yes

Model #	Lumen Output	Firearm Mount	Length/Width	Weight with Battery	Bulb Type	Focus	Battery Type & Quantity	Battery Operating Time	Pressure Switch
LT-EL338Q	200	Interchangeable Picatinny QD Lever Lock Mount	7.0"/1.66" 178mm/42.1mm	9.6oz (273g)	37mm IRB with CREE LED	Preset Spot W/ Wide Spill	CR123A x 3	1.5 hrs	Yes
LT-EL138	200	Angled Offset Picatinny Ring Mount	4.72"/1.69" 120mm/42.9mm	7.2oz (205g)	37mm IRB with CREE LED	Preset Spot W/ Wide Spill	CR123A x 1	2 hrs	Yes



**NEW**



Slide-on Picatinny Ring Mount



Pulse Dot



Solid Dot



Slide-on Picatinny Ring Mount

SCP-LS279S

**Ambidextrous Compact Green Laser**

- True Strength™ Platform with Smart Spherical Structure and 4 Point Retention for Precise Windage/Elevation Adjustment and Zero Retention
- Ambidextrous Momentary/Constant On/Off Operating Switches
- Aircraft Aluminum Construction with a Matte Black Finish
- **IPX7 Waterproof Rated**



Windage/Elevation Adjustment    Ambidextrous Momentary/Constant On/Off Switches

Model #	Range	Firearm Mount	Length/Width/Height	Weight with Battery	Beam Diameter	Battery Type & Quantity	Battery Operating Time	Pressure Switch
SCP-LS279S	546.8yds (500m)	Low Profile Picatinny Mount	2.38"/1.18"/1.15" 60.4mm/30mm/29.3mm	2.1oz (61g)	1.1" (28mm) @ 16.4 yds (15m)	1/3N x 1	3 hrs	N/A
SCP-LS279	1093.6yds (1,000m)	Slide-on Picatinny Ring Mount	3.37"/0.87"/0.93" 85.6mm/22mm/23.6mm	2oz (57g)	0.7" (18.5mm) @ 16.4yds (15m)	CR2 x 1	3.3 hrs	Yes
SCP-LS289S	328.1yds (300m)	Low Profile Picatinny Mount	3.37"/1.89"/1.34" 85.5mm/48mm/34mm	5.2oz (133g)	1.3" (32mm) @ 10 yds (9.1m) 3.8" (96mm) @ 30 yds (27.4m) 6.3" (160mm) @ 50 yds (45.7m)	CR2 x 1	2.5 hrs	Yes

SCP-LS289S

**Instant Target Aiming BullDot® Compact Green Laser**

- Expanding Dot with 8" Dia. @ 50Yds
- Rapid Target Acquisition in High Stress Situations



Low Profile Picatinny Mount    Pressure Switch Included

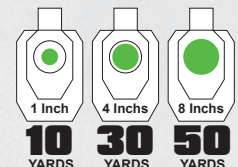

SCP-LS279

**Compact Green Laser**

- Precise Windage and Elevation Adjustment
- Matte Black Anodized Finish for Wear Resistance



Windage/Elevation Adjustment    Momentary On/Off Pressure Switch Included

SCP-LS200

**Sub-compact Red Laser**

- Sub-compact 1.2" Length
- 4-point Design Featuring Double Coil Erector Return Springs Housed in a Super Compact Body with True Strength™ Platform to Achieve the Most Precise Windage/Elevation Adjustment
- Dual Operating Modes Solid Dot and Pulse Dot, Complete with 1-Click Memory



Windage/Elevation Adjustment    Low Profile Picatinny Mount

Model #	Range	Firearm Mount	Length/Width/Height	Weight with Battery	Beam Diameter	Battery Type & Quantity	Battery Operating Time	Pressure Switch
SCP-LS200	546.8yds (500m)	Low Profile Picatinny Mount	1.19"/1.27"/1.28" 30.2mm/32.2mm/32.5mm	1.3oz (36g)	1.1" (28mm) @ 16.4 yds (15m)	LR48 (AG5) x 4	1 hr	N/A
SCP-LS268	546.8yds (500m)	Slide-on Picatinny Ring Mount	65.8mm/20mm/20mm 2.59"/0.79"/0.79"	1.1oz (30g)	0.6" (16mm) @ 16.4yds (15m)	LR44 x 4	1.3 hrs	Yes

SCP-LS268

**W/E Adjustable Compact Red Laser**

- Precise Windage/Elevation Adjustment
- Powerful Long Range Beam with Pinpoint Accuracy
- Aircraft Aluminum Construction with a Matte Black Anodized Finish

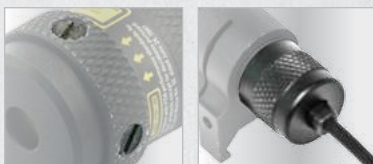

Windage/Elevation Adjustment    Momentary On/off Pressure Switch Included



# 2 IN 1 LASER/FLASHLIGHT COMBOS



LT-ELP28R

## Sub-compact Light/Red Laser Combo

- Long Range Red Laser with True Strength™ Smart Spherical Structure for Precise Windage and Elevation Adjustments
- 3 Settings: a) Dual Light and Laser Push Buttons, b) Pressure Switch Mode, c) Shut-off Mode Completely Deactivates the Unit



Constant On/off Push Buttons



Quick Plug-in Momentary On/off Pressure Switch



LT-ELP38Q-A

US PATENT: 8,397,421

## 400 Lumen Light/Red Laser Combo

- Rotating Laser Bracket Provides 10 Locking Positions Around the Light to Place the Laser
- Dual-function Flashlight End Cap with Push-button Momentary On/Off or Constant Twist On/Off Activation
- Flashlight and Laser Pressure Switches Included

LASER



Constant On/off Push Buttons

FLASHLIGHT



Momentary Push Button and Constant Twist On/Off Operations



LT-ELP39Q-A

US PATENT: 8,397,421

## 400 Lumen Light/Green Laser Combo



Picatinny QD Lever Lock Mount



Rotating Laser Bracket Provides 10 Locking Positions Around the Light to Place the Laser



# RING MOUNTS AND PRESSURE SWITCHES



RG-FL27MC

## Offset Flashlight Ring Mounts

- Mounts directly to Keymod or M-LOK® Interface (Depending on Model) for Close to Bore Alignment
- Snag-free Low Profile Design
- Removable Offset Mount Provides 1.60" Forward or Rearward Offset in addition to the Flashlight Ring's 1.12" Vertical or Downward Offset
- Complete with 2 Inserts to Accept 27mm, 25.4mm (1"), or 20mm Flashlight Tube Diameters

[Also Refer to P. 59]



RG-FL27KC



RG-FL138

## Angled Offset Picatinny Ring Mount

- Flashlight Ring Mount with Angled Offset for Optimal Close to Low Profile Mounting
- Twist-lock Mount to Fit on any Picatinny Rail
- Lightweight, Precision Machined Aluminum with a Matte Black Finish
- Complete with 2 Inserts to Accept 25.4mm (1"), or 20mm Flashlight Tube Diameters

[Also Refer to P. 59]

TL-PSL099-A

TL-PSLS268

## Pressure Switches

- Provides Momentary On/Off Activation Only

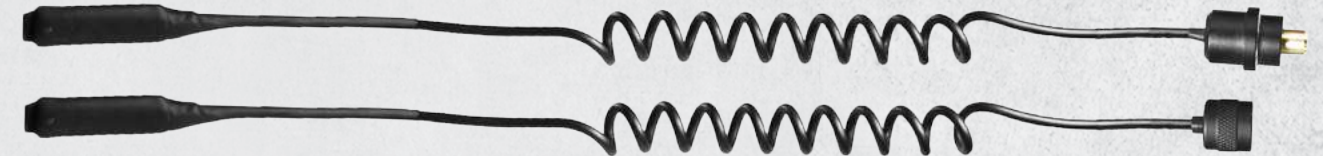

Model #	Flashlight Lumen Output	Firearm Mount	Light Bulb	Flashlight Focus	Laser Range	Beam Diameter	Length/Width/Height	Weight with Battery	Battery Type & Quantity (Light)	Battery Operating Time (Light)	Battery Type & Quantity (Laser)	Battery Operating Time (Laser)	Pressure Switch
LT-ELP38Q-A	400 Lumen	Picatinny QD Lever Lock Mount	23mm IRB with CREE LED	Preset Flood	546.8yds (500m)	0.63" (16mm) @ 16.4yds (15m)	5.12"/1.92"/1.27" 130mm/48.8mm/32.3mm	7.3oz (209g)	CR123A x 2	3 hrs	LR44 x 4	1.3 hrs	Yes
LT-ELP39Q-A	400 Lumen	Picatinny QD Lever Lock Mount	23mm IRB with CREE LED	Preset Flood	546.8yds (500m)	0.7" (17.8mm) @ 16.4yds (15m)	5.35"/2.24"/1.28" 136mm/56.8mm/32.5mm	8.6oz (243g)	CR123A x 2	3 hrs	CR2 x 1	3.3 hrs	Yes
LT-ELP28R	120 Lumen	Low Profile Picatinny Mount	16mm IRB with CREE LED	Preset Flood	164yds (150m)	1.1" (28mm) @ 16.4 yds (15m)	2.04"/1.97"/1.69" 51.8mm/50mm/43mm	2.9oz (83g)	CR2 x 1	1 hr	N/A	45 mins	Yes

Model #	Ring Diameter	Compatible Lights	Model #	Ring Diameter	Compatible Lights
RG-FL27MC	No Insert (27mm)	N/A	RG-FL138	No Insert (27mm)	N/A
	Insert 2 (25.4mm)			Insert 2 (25.4mm)	
	Insert 1 + Insert 2 (20mm)			Insert 1 + Insert 2 (20mm)	
RG-FL27KC	No Insert (27mm)	N/A	Model #	Length	Compact Light/Laser
	Insert 2 (25.4mm)		TL-PSTL099-A	10"-21"	LT-TL099PR2, LT-EL228Q-A, LT-EL268-A, LT-EL338Q, LT-ELP38Q-A, LT-ELP39Q-A, LT-EL202R-A
	Insert 1 + Insert 2 (20mm)		TL-PSLS268	10"-25"	SCP-LS268, LT-ELP38Q-A, LT-ELP38





## INTRODUCTION

Just like all of our other categories of products, Leapers UTG® continuously strives to provide a comprehensive selection of firearms accessories and parts. Trust in us to continue to listen to our customer's suggestions and feedback and devote our full energy, attention, and effort to developing what is asked of us from you, our loyal customers. We do not just offer parts and tools; every product incorporates the UTG® touch. Designed, developed, prototyped, and executed entirely in-house. If you find yourself here looking to accessorize and kit out your MSR from the ground up, you need not look any further. Our full lineup of products are always ready out of the box and come complete with everything you need to get up and gunning. Be sure to check out the new UTG PRO® USA Made flip-up sights and handguards, along with an extensive new series of M-LOK®, Keymod, and Picatinny foregrips, hand stops, and angled foregrips. Lastly, be sure to take a look at our new series of AR receiver components and polymer magazines.

**LEAPERS, INC.**  
**THE BEST NEVER REST**  
**LIFETIME WARRANTY**

## ABSOLUTE COMMITMENT TO QUALITY



Intensive Engineering and Programming



State of the Art Manufacturing



Optimized Fixture Design and Layout



Total Commitment to Precision



Relentless Search for Excellence



Best Valued Products on the Market

# ACCESSORIES AND PARTS

UTG® A VAST SELECTION FOR YOUR ONE STOP SHOPPING NEEDS

### NEW AND MUST HAVE PRODUCTS FOR 2019



# UTG PRO +0 PISTOL BASE PADS

PROUDLY MADE IN U.S.A.

- MADE IN USA
- PRECISION MACHINED
- 6061-T6 ALUMINUM
- +0 +0 CAPACITY

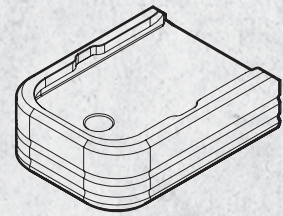

- AVAILABLE COLOR(S)
- MATTE BLACK ANODIZED
  - MATTE BLUE ANODIZED
  - MATTE RED ANODIZED
  - MATTE BRONZE ANODIZED



## UTG PRO® +0 Pistol Magazine Base Pads

- Models Available for Some of the Most Popular Double Stack Pistols on the Market
- 0.347" Extended Height and 1 oz. Weight Helps Facilitate Faster Reloads with or without a Magwell
- IDPA & USPSA Legal



**+5 CAPACITY**  
**COMING SOON!!!**  
- FOR SELECT MODELS -  
**BASE PADS**

**IDPA/USPSA LEGAL**

**1oz. WEIGHT**



Item #	Black	PUBGL01	PUBGL02	PUBCZ01	PUBHK01	PUBSG01	PUBSI01	PUBSW01	PUBWR01
Make/Model		<b>Glock</b> Small Frame	<b>Glock</b> Large Frame	<b>CZ</b> • P07 • P10C 9/40	<b>HK</b> • VP9 • P30 9/40	<b>SIG</b> • P320 9/40 • P320 X5 (w/o mag well)	<b>SPRINGFIELD ARMOY</b> • XDm 9mm (with square magazine spring)	<b>SMITH &amp; WESSON</b> • M&P 9/40 (double stack only)	<b>WALTHER</b> • PPK 9/40
Capacity							+0		
Weight							1 oz		
Other Available Colors									
B=Blue	PUBGL01B	PUBGL02B	PUBCZ01B	PUBHK01B	PUBSG01B	PUBSI01B	PUBSW01B	PUBWR01B	
R=Red	PUBGL01R	PUBGL02R	PUBCZ01R	PUBHK01R	PUBSG01R	PUBSI01R	PUBSW01R	PUBWR01R	
Z=Bronze	PUBGL01Z	PUBGL02Z	PUBCZ01Z	PUBHK01Z	PUBSG01Z	PUBSI01Z	PUBSW01Z	PUBWR01Z	

# UTG PRO ULTRA SLIM GLOCK® MAGWELLS

PROUDLY MADE IN U.S.A.

- MADE IN USA
- PRECISION MACHINED
- 6061-T6 ALUMINUM

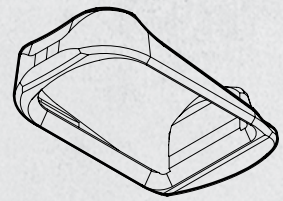
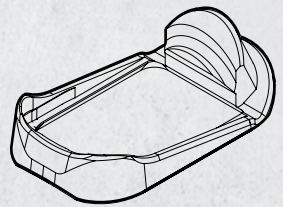

- AVAILABLE COLOR(S)
- MATTE BLACK ANODIZED
  - MATTE BLUE ANODIZED
  - MATTE RED ANODIZED



## UTG PRO® Ultra Slim Glock® Magwells

- 6061-T6 Aluminum Construction, Matte Anodized Finish, Lightweight, with an Ultra Slim Profile
- One-piece Construction for a Tailored Fit
- All Edges and Corners Chamfered and Dehorned
- Carry-oriented Funnel Height and Angle Corrects Misaligned Magazine Insertions for Faster Reloads



**NEW**

Item #	Black	PUMGL01	PUMGL02	PUMGL03	PUMGL04
Make/Model		Glock® 17, 22, 34 Gen. 3 or 4	Glock® 17, 34 Gen. 5	Glock® 19, 23 Gen. 3 or 4	Glock® 19 Gen. 5
Weight		.4oz	.4oz	.4oz	.4oz
Other Available Colors					
B=Blue	PUMGL01B	PUMGL02B	PUMGL03B	PUMGL04B	
R=Red	PUMGL01R	PUMGL02R	PUMGL03R	PUMGL04R	





# AR15 OPS READY S4 4 POSITION STOCKS & ASSEMBLIES

PROUDLY MADE IN U.S.A.



MADE IN USA



HIGH STRENGTH POLYMER



US PAT. D818074



ADJUSTABLE STOCK

### Ultra Sub-compact Stock

4.28"

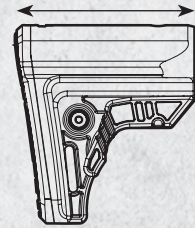

AVAILABLE COLOR(S)

BLACK POLYMER

FDE POLYMER



PARTS INCLUDED IN KIT



Buffer Spring



6 Position Mil-spec Extension Tube

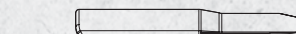

Removable Cheek Riser



Recoil Buffer

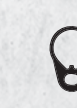

Receiver End Plate



Castle Nut

## UTG PRO® AR15 Ops Ready S4 4 Position Stocks & Assemblies

- Stock and Cheek Rest Molded from Impact Resistant High Strength Polymer
- Lightweight, Ultra Sub-compact Profile, Ideal for Compact Applications
- Built for Heavy Duty Use with the Tightest Tolerance Controls to Provide the Most Secure Fit and Function
- Included Removable Cheek Rest for Improved Shooting Stability and Comfort



Item #	RBUS4BM	RBUS4DM	RBUS4BMS	RBUS4DMS
Type	Mil-spec			
	Stock Assembly		Stock Only	
Color	Black	FDE	Black	FDE
Dimensions	4.28" Length x 1.69" Width x 4.75" Height			
Weight	15.50 oz		5.65 oz	



# AR15 OPS READY S3 6 POSITION STOCKS & ASSEMBLIES

PROUDLY MADE IN U.S.A.



MADE IN USA



HIGH STRENGTH POLYMER



US PAT. D773005



ADJUSTABLE STOCK

### Sub-compact Stock

6.05"

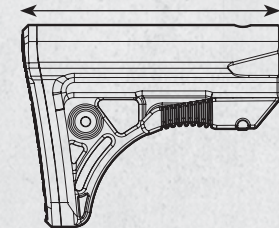

AVAILABLE COLOR(S)

BLACK POLYMER

FDE POLYMER



PARTS INCLUDED IN KIT



Buffer Spring

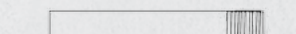

6 Position Mil-spec Extension Tube

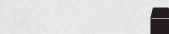

Recoil Buffer



Receiver End Plate



Castle Nut

## UTG PRO® AR15 Ops Ready S3 6 Position Stocks & Assemblies

- Stock Molded from Impact Resistant High Strength Polymer
- Sub-compact Profile for Lightweight, Comfortable Performance
- Built for Heavy Duty Use with the Tightest Tolerance Controls to Provide the Most Secure Fit and Function



Item #	RBUS3BM	RBUS3DM	RBUS3BMS	RBUS3DMS
Type	Mil-spec			
	Stock Assembly		Stock Only	
Color	Black	FDE	Black	FDE
Dimensions	6.05" Length x 1.50" Width x 4.75" Height			
Weight	16.87 oz		7.02 oz	





# AR15 OPS READY S2 6 POSITION STOCKS AND ASSEMBLIES

PROUDLY MADE IN U.S.A.



MADE IN USA



HIGH STRENGTH POLYMER



ADJUSTABLE STOCK

Full Size Stock  
8.00"

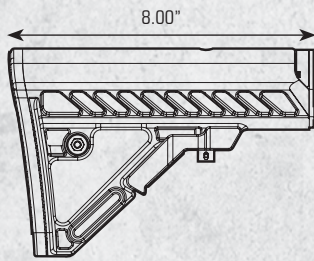

AVAILABLE COLOR(S)

BLACK POLYMER

FDE POLYMER



PARTS INCLUDED IN KIT



Buffer Spring



6 Position Mil-spec Extension Tube



Recoil Buffer



Receiver End Plate



Castle Nut

## UTG PRO® AR15 Ops Ready S2 6 Position Stocks and Assemblies

- Stock Molded from Impact Resistant High Strength Polymer
- Lightweight Slim Profile with Extended 7.50" Length for Increased Length of Pull
- Built for Heavy Duty Use with the Tightest Tolerance Controls to Provide the Most Secure Fit and Function



Extended Front End Enables Stock to be Flush with the Lower Receiver for a More Integral Look



Item #	RBUS2BM	RBUS2DM	RBUS2BMS	RBUS2DMS
Type	Mil-spec			
	Stock Assembly		Stock Only	
Color	Black	FDE	Black	FDE
Dimensions	8" Length x 1.50" Width x 5.25" Height			
Weight	19.65oz		9.92oz	



# AR15 OPS READY S1 6 POSITION STOCKS AND ASSEMBLIES

PROUDLY MADE IN U.S.A.



MADE IN USA



HIGH STRENGTH POLYMER



ADJUSTABLE STOCK

Full Size Stock  
8.50"

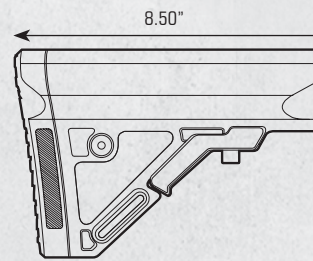

AVAILABLE COLOR(S)

BLACK POLYMER

FDE POLYMER



PARTS INCLUDED IN KIT



Buffer Spring

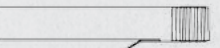

6 Position Mil-spec Extension Tube



Recoil Buffer



Receiver End Plate



Castle Nut

## UTG PRO® AR15 Ops Ready S1 6 Position Stocks and Assemblies

- Stock Molded from Impact Resistant High Strength Polymer
- Extended 8" Length for Increased Length of Pull
- Built for Heavy Duty Use with the Tightest Tolerance Controls to Provide the Most Secure Fit and Function



Dual Storage Compartments with Removable Waterproof Caps Store Up to 8 CR123 Batteries



Extended Front End Enables Stock to be Flush with the Lower Receiver for a More Integral Look



Item #	RBUS1BM	RBUS1DM	RBUS1BMS	RBUS1DMS
Type	Mil-spec			
	Stock Assembly		Stock Only	
Color	Black	FDE	Black	FDE
Dimensions	8.50" Length x 2.25" Width x 5.50" Height			
Weight	23.05oz		12.60oz	



# AR15 OPS READY S5 FIXED STOCK

PROUDLY MADE IN U.S.A.

- MADE IN USA
- HIGH STRENGTH POLYMER
- FIXED STOCK

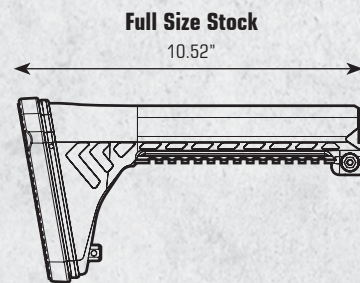

- AVAILABLE COLOR(S)  
BLACK POLYMER
- PARTS INCLUDED



## UTG PRO® AR15 Ops Ready S5 Fixed Stock

- Stock Molded from Impact Resistant High Strength Polymer
- Built for Heavy Duty Use with the Tightest Tolerance Controls
- Slim Lightweight Ergonomic Profile
- Built-in Scalloped Picatinny Rail for Attaching Other Accessories



Item #	RBUS5B
Type	Stock Only
Color	Black
Dimensions	10.52" Length x 2" Width x 5.59" Height
Weight	14.80 oz



# AR15 & AR308 STANDARD BUTT STOCK ASSEMBLIES

## UTG PRO® AR15 Ops Ready U6 6 Position Stock Assemblies

- Stock Molded from Impact Resistant Polymer with Reinforced Stress Points for Maximum Durability
- Built for Heavy Duty Use with the Tightest Tolerance Controls to Provide the Most Secure Fit and Function
- Dual Standard Sling Loop Attachment Points
- Lightweight Design with a Classic Look and Feel



- PARTS INCLUDED
- Buffer Spring
- Recoil Buffer
- Receiver End Plate
- Castle Nut
- 6 Position Extension Tube

### ADDITIONAL ACCESSORIES AVAILABLE



## AR15 Ergonomic Butt Pad for U6 6 Position Collapsible Stock

- Provides Additional Comfort when Shouldered

## AR15 Standard A2 Fixed Butt Stock Assembly

- Stock Molded from Impact Resistant High Strength Polymer



- PARTS INCLUDED
- Buffer Spring
- Recoil Buffer
- Stock Screw
- Stock Spacer
- Rifle Length Extension Tube

Item #	RBU6BM	RBU6DM	RBU6BC	RB-T469B	RB-T469D	RB-T308FB
Platform	AR15					
Type	6 Position Adjustable			Fixed A2		
	Stock Assembly					
	Mil-spec		Commercial-spec		N/A	
Color	Black	FDE	Black	Black	FDE	Black
Dimensions	6.88" Length x 1.68" Width x 5.15" Height			10.75" Length x 1.62" Width x 5.14" Height		
Weight	16.90oz	17oz	18.20oz	26.40oz		25.50 oz

## AR308 Standard A2 Fixed Butt Stock Assembly

- Stock Molded from Impact Resistant High Strength Polymer
- Compatible with Armalite AR-10, DPMS LR-308, S&W M&P10, and Other Clones



- PARTS INCLUDED
- Buffer Spring
- Recoil Buffer
- Stock Screw
- Stock Spacer
- Rifle Length Extension Tube

- MADE IN USA
- PRECISION MACHINED
- 6065-T6 ALUMINUM
- 7075-T6 ALUMINUM

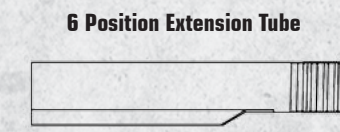

- AVAILABLE COLOR(S)**
- MATTE BLACK ANODIZED
  - MATTE BLUE ANODIZED
  - MATTE RED ANODIZED
  - MATTE BRONZE ANODIZED
  - FDE CERAKOTE®

- PARTS INCLUDED IN KIT**



**UTG PRO® AR15 & AR308 6 Position Receiver Extension Tubes & Kits**

- Extension Tube CNC Machined from 7075-T6 or 6061-T6 Aircraft Aluminum with Precisely Rolled Threads for Durable Thread Engagement with Lower Receiver
- Tightest Tolerance Controls for a Secure Fit and Function with Various Collapsible Stocks
- Finished in a Matte Black/Blue/Red/Bronze Type III Class II Hard Coat Anodization or FDE CERAKOTE®



	7075-T6					6061-T6					
<b>AR15 Mil-spec 6 Position Receiver Extension Tubes</b>	BLACK	BLUE	RED	BRONZE	FDE	<b>AR15 Mil-spec 6 Position Receiver Extension Tube Kits</b>	BLACK	FDE	<b>AR15 Commercial-spec 6 Position Receiver Extension Tube</b>	<b>AR308 6 Position Receiver Extension Tube</b>	
	TLU001MS	TLU001	TLU001B	TLU001R	TLU001Z	TLU001D	TLU001-KIT	TLU001D-KIT	TLU006	TLU002	
Item # (Model)	TLU001-KIT	TLU001D-KIT	TLU001MS	TLU001	TLU001R	TLU001B	TLU001Z	TLU001D	TLU006	TLU002	
Platform	AR15									AR308	
Type	Mil-spec						Commercial-spec			Mil-spec	
	Tube Kit		Tube Only								
Material	6061-T6		7075-T6					6061-T6			
Color	Black	FDE	Black	Black	Red	Blue	Bronze	FDE	Black		
Dimensions	7.25"x1.14"x1.44"									7.80"x1.17"x1.45"	7.90"x1.14"x1.44"
Weight	9.25oz							4oz		5oz	4oz

**UTG PRO® AR Pistol Receiver Extension Tube & Kits**

- 1.2" OD Receiver Extension Tube Compatible with AR15 Lower Receivers
- Precision Machined from 7075-T6 Aircraft Aluminum with a Dry Film Lube Coated Interior for Smoother and More Reliable Cycling
- Finished in a Matte Black Type III Class II Hard Coat Anodized Finish
- Compatible with Standard AR15 Type Buffers and Springs
- Compatible with Most AR Pistol Receiver Extension Tube Covers



	TLU008	TLU008-KIT	TLU009	TLU009-KIT
Item # (Model)	TLU008	TLU008-KIT	TLU009	TLU009-KIT
Platform	AR Pistol			
Type	Tube Only	Tube Kit	Tube Only	Tube Kit
Material	7075-T6			
Color	Black			
Dimensions	OD 1.2"x7.24"		OD 1.25"x8.5"	
Weight	4oz	9.9oz	6.2oz	12.2oz

**UTG PRO® AR Pistol Extended Receiver Extension Tube & Kits**

- Precision Machined from 7075-T6 Aircraft Aluminum with a Dry Film Lube Coated Interior for Smoother and More Reliable Cycling
- Finished in a Matte Black Type III Class II Hard Coat Anodized Finish
- Compatible with Standard AR15 Type Buffers and Springs
- 8.5" Extended Length and Compatible with Gear Head Works Tailhook Mod 1 Brace and or Most AR Pistol Receiver Extension Tube Covers



	TLU009	TLU009-KIT
Item # (Model)	TLU009	TLU009-KIT
Platform	AR Pistol	
Type	Tube Only	Tube Kit
Material	7075-T6	
Color	Black	
Dimensions	OD 1.25"x8.5"	
Weight	6.2oz	12.2oz

**ADDITIONAL ACCESSORIES AVAILABLE**

- AR15 H3 Recoil Buffer** (RB-T6BFH3)
  - 3 Heavy Tungsten Weights
  - Total Weight 5.4 oz [Also Refer to P.144]
- AR15 H2 Recoil Buffer** (RB-T6BFH2)
  - 2 Heavy Tungsten Weights and 1 Steel Weight
  - Total Weight 4.6 oz [Also Refer to P.144]
- AR15 Carbine Recoil Buffer** (RB-T6BFHC)
  - 3 Steel Weights
  - Total Weight 3.0 oz [Also Refer to P.144]



# AR15 FLIP-UP FRONT / REAR SIGHTS & TOOLS

NEW



TLUF5003

## UTG PRO® Spring-loaded Flip-up Front Sight

- Precision Machined from Aircraft Aluminum with a Matte Black Anodized Finish
- Push-button Activated Sight Tower Automatically Locks into the Upward Position when Deployed
- Standard Elevation Adjustable A2 Front Sight Post is Interchangeable with Most Aftermarket Posts
- Utilizes a Single Locking Torx Screw and Square-shaped Integral Recoil Stops for a Secure Zero Hold and Return to Zero on Picatinny Rails



NEW



TLUR5003

## UTG PRO® Spring-loaded Flip-up Rear Sight

- Precision Machined from Aircraft Aluminum with a Matte Black Anodized Finish
- Push-button Activated Sight Tower Automatically Locks into the Upward Position when Deployed
- Dual Aperture Rear Sight with Tool-free Windage Adjustment Wheel
- Utilizes a Single Locking Torx Screw and Square-shaped Integral Recoil Stops for a Secure Zero Hold and Return to Zero on Picatinny Rails



US PAT. 10030935



PATENT PENDING

MNT-745

## ACCU-SYNC® 45 Degree Flip-up Front Sight

- Precision Machined from Aircraft Aluminum with a Matte Black Finish
- 45 Degree Angled Offset Allows Access to Iron Sights Simultaneously with Primary Mounted Magnified Optics
- Posi-lock Retention Plunger Locks Sight in Deployed Position
- Tool-free Front Sight Post Elevation Adjustment Wheel
- Utilizes a Single Locking Torx Screw and Square-shaped Integral Recoil stops for a Secure Zero Hold and Return to Zero on Picatinny Rails



US PAT. 10030935



PATENT PENDING

MT-945

## ACCU-SYNC® 45 Degree Flip-up Rear Sight

- Precision Machined from Aircraft Aluminum with a Matte Black Finish
- 45 Degree Angled Offset Allows Access to Iron Sights Simultaneously with Primary Mounted Magnified Optics
- Posi-lock Retention Plunger Locks Sight in Deployed Position
- Dual Aperture Rear Sight with Tool-free Windage Adjustment Wheel
- Utilizes a Single Locking Torx Screw and Square-shaped Integral Recoil Stops for a Secure Zero Hold and Return to Zero on Picatinny Rails



US PAT. 10119784



PATENT PENDING

MNT-757

## ACCU-SYNC® Spring-loaded Flip-up Front Sight

- Precision Machined from Aircraft Aluminum with a Matte Black Finish
- Lightweight, Space Saving, Fold Over Design Uses Minimal Rail Space
- Posi-lock Push Button Automatically Deploys the Spring Loaded Sight and Prevents Sight from Collapsing when Deployed
- Utilizes a Single Locking Torx Screw and Square-shaped Integral Recoil Stops for a Secure Zero Hold and Return to Zero on Picatinny Rails



US PAT. 10119784



PATENT PENDING

MNT-957

## ACCU-SYNC® Spring-loaded Flip-up Rear Sight

- Precision Machined from Aircraft Aluminum with a Matte Black Finish
- Lightweight, Space Saving, Fold Over Design Uses Minimal Rail Space
- Posi-lock Push Button Automatically Deploys the Spring Loaded Sight and Prevents Sight from Collapsing when Deployed
- Dual Aperture Rear Sight with Tool-free Windage Adjustment Wheel
- Utilizes a Single Locking Torx Screw and Square-shaped Integral Recoil Stops for a Secure Zero Hold and Return to Zero on Picatinny Rails



MNT-755

## Low Profile Flip-up Front Sight

- Aluminum/Steel Construction with a Matte Black Finish
- Standard A2 Front Sight Post with Precise Elevation Adjustment
- Low Profile 3mm Locking Bolt and Mounting Deck Securely Attaches to any Picatinny Rail



MNT-955

## Low Profile Flip-up Rear Sight

- Aluminum/Steel Construction with a Matte Black Finish
- Dual Aperture Rear Sight with Tool-free Windage Adjustment Wheel
- Low Profile 3mm Locking Bolt and Mounting Deck Securely Attaches to any Picatinny Rail



SCP-FTA24

## 4-Prong A2 Front Sight Tool

- Machined Steel with Knurled Surface Texture
- For Use on 4-prong A2 Front Sight Posts



SCP-A1245-A

## Dual A2 Front Sight Tool

- Machined Steel with Knurled Surface Texture
- For Use on Both 4 and 5-prong Front Sight posts

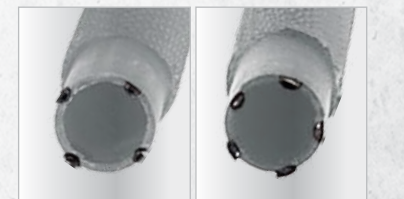
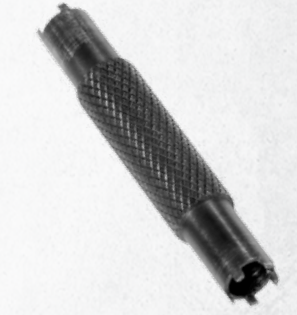



# AR15 FIXED FRONT & REAR SIGHTS



# AR15 CARRY HANDLE SIGHTS



# SHOTGUN SIGHTS



**LOW PROFILE SIGHT**  
FOR SAME PLANE APPLICATIONS

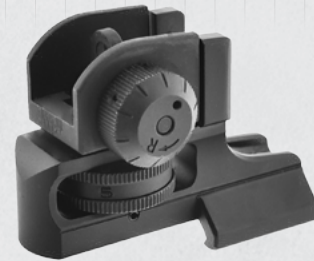

**Super Slim Rear Sight** (Designed to Match MT-754X Front Sight)

- Low Profile Super Slim Front Sight** (Designed to Match MT-950RS03 Rear Sight)
- Low Profile Front Sight with Adjustable A2 Front Sight Post, Fits on Picatinny Handguard or High Profile Gas Block Levelled with Flat Top Upper Receiver
  - Utilizes a Locking Torx Screw Side Plate and Integral Square-shaped Recoil Stop to Ensure a Secure Zero Hold
  - CNC Machined 6061-T6 Aircraft Aluminum and Steel Construction with a Matte Black Finish

- Precision CNC Machined 6061-T6 Aircraft Aluminum Base with Steel A2 Sight Assembly
- Slim and Lightweight Profile with a Durable Wear Resistant Matte Black Finish
- Tool-free Windage and Elevation Adjustment with Dual Apertures
- Utilizes a Single Locking Torx Screw and Square-shaped Integral Recoil Stop for a Secure Zero Hold and Return to Zero on MIL-STD-1913 Picatinny Rails



**HIGH PROFILE SIGHT**  
FOR LOWERED OFFSET GAS BLOCK APPLICATIONS



**Mil-Spec Compact A2 Rear Sight**

- High Profile Super Slim Front Sight** (MT-750X)
- High Profile Front Sight with Adjustable A2 Front Sight Post, Fits Lowered Offset Picatinny Railed Gas Blocks
  - Utilizes a Locking Torx Screw Side Plate and Integral Square Shaped Recoil Stop to Ensure a Secure Zero Hold
  - CNC Machined 6061-T6 Aircraft Aluminum and Steel Construction with a Matte Black Finish

- Precision Machined from Aircraft Aluminum and Steel with a Matte Black Finish
- Slim Profile and Base Uses Minimal Rail Space
- Tool-free Windage and Elevation Adjustment Steel A2 Sight Assembly with Dual Apertures
- Low Profile Locking Retention Thumb Wheel and Side Plate

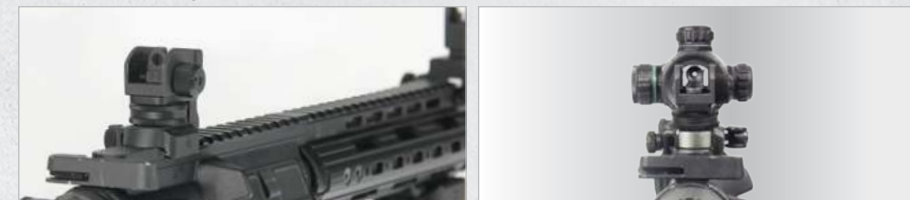
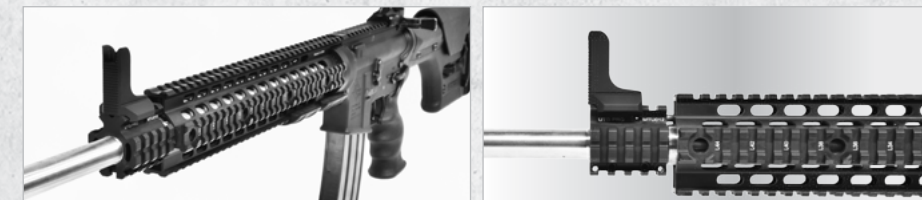

**UTG PRO® Mil-spec Forged Carry Handle Sight**

- Mil-spec Match Grade Detachable Carry Handle with A2 Sight Assembly
- Picatinny Mounting Base with Full Length Locking Plate and Dual Oversized Locking Thumb Wheels
- Forged 7075-T6 Aluminum and Steel Construction Finished in a Matte Black Anodization
- Steel A2 Sight Assembly Provides Precise and Reliable Windage/Elevation Adjustment, Complete with Dual Aiming Apertures

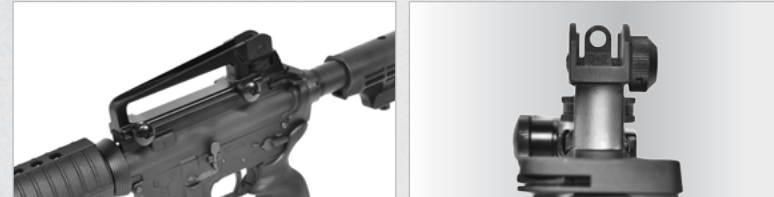

**Enhanced Carry Handle Rear Sight** (OEM)

- Utilizes a Full Length Two Point Locking Side Plate with Low Profile Thumb Wheels and Four Integral Recoil Stops to Ensure a Secure Zero Hold
- CNC Machined 6061-T6 Aluminum and Steel Construction with a Matte Black Finish



**MNT-910 Sub-compact Rear Sight**

- Precision Machined Aircraft Aluminum with a Matte Black Finish
- Designed to Match MNT-722 & 716 Clamp-on Front Sights
- Optimally Sized Aiming Aperture
- Complete Windage/Elevation Adjustment in an Extremely Sub-compact and Lightweight Design
- One Piece Integral Picatinny Mounting Base



For Mossberg 12 Ga. & Clones

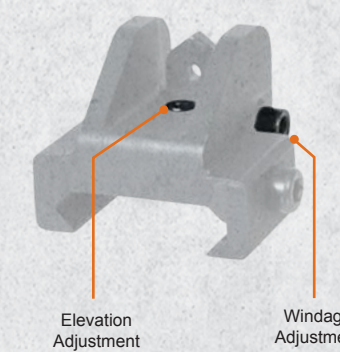
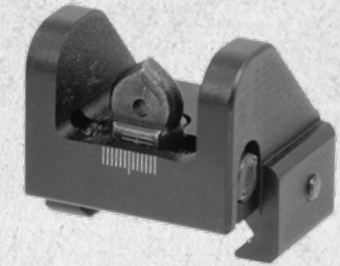

**MNT-722 Clamp-on Front Sight With Elevation Adjustable Front Sight Post**

- Fits Mossberg 12Ga. Shotgun and Clones Equipped with Front Sight Bead
- Designed to Match MNT-910 Sub-compact Rear Sight
- Complete with 2 in 1 Sight Adjustment Tool



For Mossberg 12 Ga. & Clones







TL-ARCH01  
**Standard Charging Handle**

- Forged from Aircraft Aluminum Construction with a Matte Black Finish
- Compatible with Standard Mil-spec AR15 Upper Receivers



**NEW**  
TL-TKSCH  
**Ambi Charging Handle**

- Minimalist Inspired, Unobtrusive, and Designed to Have a Classic Look and Feel
- Aircraft Aluminum Construction with a Matte Black Finish
- Ambidextrous Design

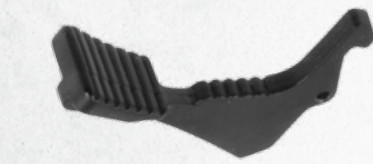

TL-CHL01  
**Extended Charging Handle Latch**

- Increased Surface Area for Faster Manipulation Under Stress
- Heavy Duty Steel Construction with a Matte Black Finish
- Fits Standard AR15 Charging Handles



**NEW**  
TL-TKSTG  
**Enlarged Trigger Guard**

- Optimized Geometry for Use While Wearing Gloves
- Closes the Gap Found Between the Rear of the Trigger Guard and the Front of the Pistol Grip



RB-T6BFH3  
**AR15 H3 Recoil Buffer**

- 3 Heavy Tungsten Weights
- Potentially Increases Dwell Time, Eases Extraction, and Reduces Felt Recoil
- Total Weight 5.4 oz



RB-T6BFH2  
**AR15 H2 Recoil Buffer**

- 2 Heavy Tungsten Weights and 1 Steel Weight
- Potentially Increases Dwell Time, Eases Extraction, and Reduces Felt Recoil
- Total Weight 4.6 oz



**NEW**  
TL-TKSLT  
**Adjustable Safety Selector**

- Changeable Between a 45 or 90 Degree Throw
- Features Interchangeable and Different Length and Shape Safety Levers for a Tailored Fit and Function Specific to the User
- Ambidextrous Design
- For Semi-automatic Fire Control Groups Only

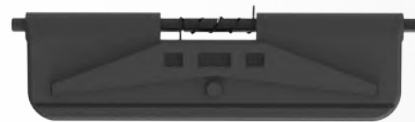

**NEW**  
TL-TKSDC  
**Quick Assemble Dust Cover**

- Tool-free Design and Installation



RB-T6BFHC  
**AR15 Carbine Recoil Buffer**

- 3 Steel Weights
- Total Weight 3.0 oz



**NEW**  
TL-TKSBC  
**Enlarged Bolt Catch**

- Angled and Enlarged Surfaces Facilitate Faster Reloads and Malfunction Clearing



**NEW**  
TL-TKSMB  
**Ambi Mag Release**

- Enlarged Surface Face For Easier Gloved Manipulation and Reach
- Clearance Cut to Prevent Unintentional Interference with Bolt Catch



RB-T6BM-50  
**Carbine Buffer Spring**

- Steel Construction

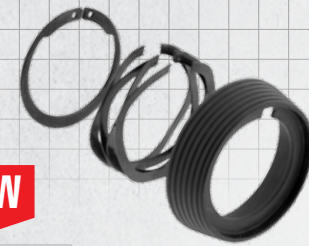

**NEW**  
TL-ARDR01  
**Standard Delta Ring Assembly**

- Aircraft Aluminum and Steel Construction with a Matte Black Finish
- Compatible with Standard Mil-Spec AR15 Upper Receivers
- Includes Delta Ring, Weld Spring, and Snap Ring



TL-T6TD03  
**QD Receiver End Plate**

- Designed for Standard Mil-spec AR15 Lower Receiver
- Accepts Any Quick Detach Sling Swivel with 0.37" Diameter Swivel Stud
- Solid Steel Construction with a Matte Black Finish



RB-T6BM-30 **OEM**  
**Receiver End Plate**

- Designed for Standard Mil-spec AR15 Lower Receiver
- Solid Steel Construction with a Matte Black Finish

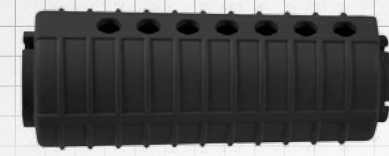

RB-TM4HBT  
**Polymer Drop-in Handguard**

- Quality Replacement Handguard for Carbine-length AR15
- Rounded Shape with Dual Aluminum Heat Shields
- Lightweight and Extremely Tough for Use Under All Weather and Environmental Conditions



**NEW**  
TL-ARBRO1  
**Standard Steel Barrel Nut**

- Heavy Duty Steel Construction with a Matte Black Finish
- Compatible with Standard Mil-Spec AR15 Upper Receivers



RB-T6BM-40 **OEM**  
**Castle Nut**

- Designed for Standard Mil-spec AR15's
- Solid Steel Construction with a Matte Black Finish



**NEW**  
TL-ARFS01  
**Standard A2 Front Sight Gas Block**

- Design to Fit Pinned Barrel with a .750" Dia. at the Gas Port
- Solid Steel Construction with a Matte Black Finish
- Comes Complete with Standard Front Sight Post, Spring, Detent, and Sling Swivel



**NEW**  
MNT-ARMGB01  
**Micro Gas Block**

- Low Profile Size Fits Underneath Most Free Float Handguards
- Precision Machined from Steel to Exacting Tolerances for Optimal Fit on .750" Diameter Barrels at the Gas Port
- Features a Durable and Corrosion Resistant Manganese Phosphate Finish
- Compatible with Direct Impingement Gas Tubes
- Includes Gas Tube Roll Pin, Serrated Self-locking Set Screws, and Installation Tool



**NEW**  
MTU012AG7  
**UTG PRO® Adjustable Micro Gas Block**

- 12 Position Gas Port Adjustments
- Low Profile, Fits Underneath Most Free Float Handguards
- Precision Machined to Exacting Tolerances for .750" Diameter Barrels at the Gas Port
- Features a Durable and Corrosion Resistant Manganese Phosphate Finish
- Compatible with Direct Impingement Gas Tubes
- Includes Gas Tube Roll Pin, Serrated Self-locking Set Screws, Adjustment Tool, and Installation Tool



TL-ARFH01  
**Standard A2 Flash Hider**

- Steel Construction with a Matte Black Hard Coat Manganese Phosphate Surface Treatment
- 1/2"-28 UNEF Thread
- Includes Crush Washer



**NEW**  
TLUMD01  
**UTG PRO® Stubby Muzzle Brake**

- Steel Construction Finished in a Matte Black Manganese Phosphate Surface Treatment for Corrosion Resistance
- 1/2"-28 UNEF Thread Compatible, Crush Washer Included
- 1.75" Length with Three Left and Right Sided Gas Dispersion Ports for Improved Recoil Reduction and Handling



**NEW**  
TLUMD02  
**UTG PRO® Muzzle Brake**

- Steel Construction Finished in a Matte Black Manganese Phosphate Surface Treatment for Corrosion Resistance
- 1/2"-28 UNEF Thread Compatible, Crush Washer Included
- 2.25" Length with Four Left and Right Sided Gas Dispersion Ports for Improved Recoil Reduction and Handling



# AR & AK/AKM POLYMER MAGAZINES



**NEW**

RBT-AM30

## AR15 30 Round Windowed Polymer Magazine

- Molded from Impact Resistant High Strength Reinforced Polymer
- High Contrast Blue Anti-tilt and Self-lubricating Follower
- Aggressively Molded Grip Texture on the Forward and Rearward Spine and Side Walls
- Windowed with Numbered Markings to Show Capacity Remaining
- Simple to Remove Base Plate for Cleaning

**NEW**

RBT-AM10

## AR15 10 Round Polymer Magazine

- Molded from Impact Resistant High Strength Reinforced Polymer
- High Contrast Blue Anti-tilt and Self-lubricating Follower
- Aggressively Molded Grip Texture on the Forward and Rearward Spine and Side Walls
- Simple to Remove Base Plate for Cleaning



**NEW**

RBT-AKM30

## AK47 30 Round Windowed Polymer Magazine

- Molded from Impact Resistant High Strength Reinforced Polymer
- Reinforced Front and Rear Locking Lugs for Increased Longevity
- High Contrast Blue Anti-tilt and Self-lubricating Follower and Constant Internal Geometry for Reliable Feeding
- Aggressively Molded Grip Texture on the Forward and Rearward Spine and Side Walls
- Windowed with Numbered Markings to Show Capacity Remaining
- Simple to Remove Base Plate for Cleaning



# AR PLATFORM ARMORER'S WRENCHES



TL-ARWR01

## AR15/AR308 Armorer's Multi-function Combo Wrench

- Provides the Tools to Install and Remove Parts Often Replaced and or Reinstalled on Both the AR15 and AR308 Platforms such as: Standard A2 Flash Hider, Delta Ring Barrel Assembly, Rifle Length Buffer Tube, Carbine Buffer Tube Castle Nut, and More
- Steel Construction with Wear Resistant Finish for Long Lasting Durability

TL-ARWR02

## Mini AR15 Armorer's Wrench

- Provides the Tools to Install and Remove Parts Often Replaced and or Reinstalled on the AR15 Platforms such as: Standard A2 Flash Hider, Delta Ring Barrel Nut Assembly, Rifle Length Buffer Tube, Carbine Buffer Tube Castle Nut, and More
- Steel Construction with Wear Resistant Finish for Long Lasting Durability

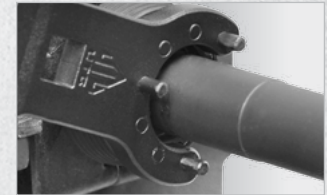

1. Delta Ring Barrel Nut

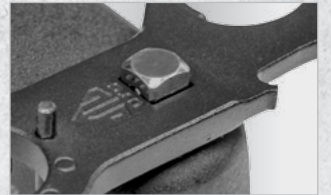

2. 1/2" and or 3/8" Socket Adaptor



3. Jam Nut - YHM® Compatible



4. UTG PRO® Super Slim Barrel Nut



5. AR15 Muzzle Device



6. A2 Stock Extension Tube



7. AR308 Muzzle Device



8. Castle Nut



9. 3-prong Muzzle Device



10. Flat Head Screw Driver



# ANGLED FOREGRIPS, INDEX MOUNTS, & HANDSTOPS

ACCESSORIES AND PARTS

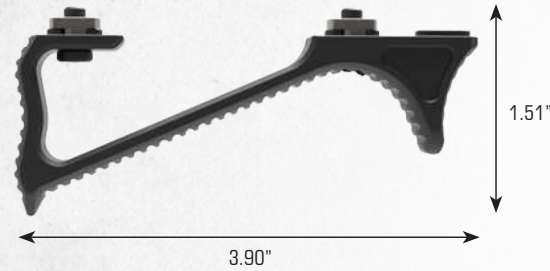

PICATINNY

**NEW**

## M-LOK®, Keymod, & Picatinny Angled Foregrrips

- 6061-T6 Aluminum Construction Available in Matte Black, Blue, or Red Anodization, and Available for M-LOK®, Keymod, and Picatinny Modular Systems
- Weight Reduction Lightening Cuts, Ergonomic Contours, and Serrated Front, Bottom, and Rear Faces for Added Grip Retention
- Promotes Proper Support Hand Memory Placement and Retention

### Additional Colors Available



Item #	Black	MT-AFGP01	MT-AFGM01	MT-AFGK01
Type		PICATINNY	M-LOK®	KEYMOD
Other Available Colors				
AB=Blue	N/A	N/A	MT-AFGM01B	MT-AFGK01B
AR=Red	N/A	N/A	MT-AFGM01R	MT-AFGK01R



M-LOK



KEYMOD



Side

Top



**NEW**

M-LOK®	TL-TRM01		PATENT PENDING
KEYMOD	TL-TRK01		

## M-LOK® & Keymod Angled Index Mounts

- Precision Machined from 6061-T6 Aluminum and Finished in a Matte Black Anodization
- Provides an Additional Support Hand Indexing and Retention Point
- Reversible Design for Installation at the 3 or 9 O'clock Handguard Positions
- Compatible with the Majority of Octagonal Handguards
- Thumb Indexing Deck Configurable for Forward or Rearward Cant
- Spacer Included for Adjusting Clearance with 12 O'clock Mounted Accessories and Pressure Switches

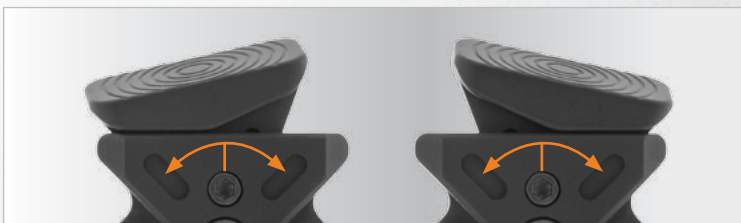

Reversible Design for Installation at the 3 or 9 O'clock Handguard Positions

**NEW**

## M-LOK® & Keymod Ultra Slim Hand Stops

- 6061-T6 Aluminum Construction Available in Matte Black, Blue, or Red Anodization for M-LOK® or Keymod Modular Systems
- Weight Reduction Lightening Cuts, Ergonomic Contours, and Serrated Front, Bottom, and Rear Faces for Added Grip Retention
- Promotes Proper Support Hand Memory Placement and Retention

### Additional Colors Available



Item #	Black	TL-HSM01	TL-HSK01
Type		M-LOK®	KEYMOD
Other Available Colors			
AB=Blue		TL-HSM01B	TL-HSK01B
AR=Red		TL-HSM01R	TL-HSK01R



M-LOK



KEYMOD



Reversible Design is Customizable to the User's Specific Requirements

ACCESSORIES AND PARTS

ANGLED FOREGRIPS, INDEX MOUNTS, & HANDSTOPS

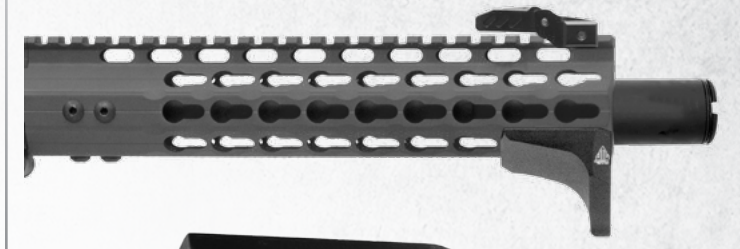

KEYMOD

TL-HS02B

## Keymod Hand Stop/Barricade Rest Kit

- 6061-T6 Aircraft Aluminum Construction with a Matte Black Finish
- Compatible with UTG PRO® Super Slim AR15/AK Keymod Handguards
- Ergonomic Contour Improves Firearm Handling and Speeds Up Transitions
- Promotes Proper Support Hand Memory Placement and Retention



Mount as a Barricade Rest to Provide Stable Support for more Accurate Shooting

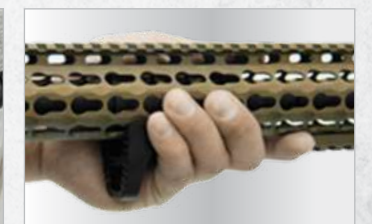

Promotes Proper Support Hand Memory Placement and Retention



# ALUMINUM VERTICAL FOREGRIPS

## Super Slim Aluminum Vertical Foregrips

- Precision CNC Machined from Aircraft Aluminum Finished in a Matte Black Anodization
- Removable Red and Blue Anodized Inserts for M-LOK® and Keymod Models Adds a Level of Personalization
- Slim, lightweight, ergonomic, with dehorned corners and melted contours for a comfortable support hand grip

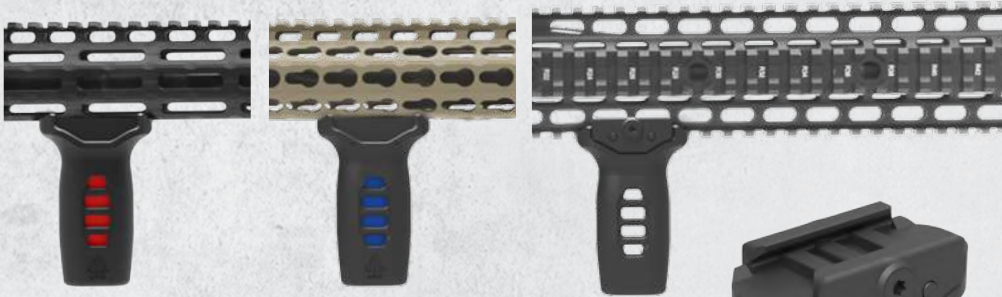

### Removable Red & Blue Anodized Inserts Included (For M-LOK & Keymod Only)



- NEW** MT-FGM01 M-LOK® Foregrip
- NEW** MT-FGK01 Keymod Foregrip
- NEW** MT-FGP01 Picatinny Foregrip

Item # (Model)	MT-FGM01	MT-FGK01	MT-FGP01	MNT-GRP001Q	MNT-GRP001SQ	MNT-GRP003Q
Operation				Fixed		
Width	1.5"	1.5"	1.5"	1.4"	1.4"	0.9"
Saddle Height	3.45"	3.45"	3.44"	4.90"	3.90"	3.45"
Weight	4.9oz	4.9oz	4.9oz	8.70oz	7.60oz	3.20oz
Total Storage Space	N/A	N/A	N/A	2.70in <sup>3</sup>	1.46in <sup>3</sup>	0.90in <sup>3</sup>

## Aluminum QD Vertical Foregrips

- Precision Machined from Aircraft Aluminum with a Matte Black Finish
- Quick Detachable Picatinny Lever Lock Mounting Base
- Posi-lock Cross Bolt and Spring Tensioned Locking Plate with Steel Insert for a Secure Installation
- Removable End Cap with Waterproof Storage within Foregrip
- Ergonomic Knurled Surface

US PATENT 8,429,843



US PATENT 8,397,421



- MNT-GRP001Q 5" QD Foregrip
- MNT-GRP001SQ 4.1" QD Foregrip
- MNT-GRP003Q 3.6" QD Foregrip



- MNT-GRP002SQ 4.7" QD Foldable Foregrip

Item # (Model)	MNT-GRP002SQ
Operation	Foldable
Width	1.4"
Saddle Height	4.60"
Weight	9.70oz
Total Storage Space	1.04in <sup>3</sup>



# POLYMER VERTICAL FOREGRIPS

- BLACK RB-FGRP170B
- FLAT DARK EARTH RB-FGRP170D

## 5 Position Foldable Foregrip

- End Cap Provides Battery Storage and Mount Tension
- Side Inserts Allow for Use of Pressure Switch
- Simple Slide-on Mounting Deck
- Reinforced Locking Mechanism for Added Durability
- 5 Position Adjustable



### 5 POSITION FOLDABLE

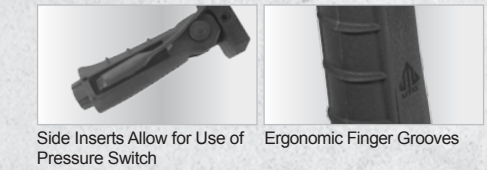

- BLACK RB-FGRP168B

## Ambidextrous Vertical Foregrip

- End Cap Provides Battery Storage and Mount Tension
- Side Inserts Allow for Use of Pressure Switch
- Simple Slide-on Mounting Deck
- Ergonomic Finger Grooves and Nonslip Grip Texture
- Molded from Impact Resistant Polymer

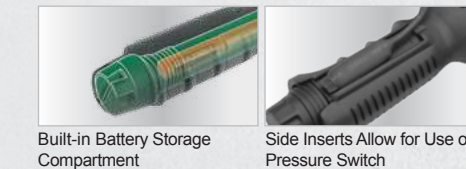

- BLACK RB-FGRP172B

## Ambidextrous Contoured Foregrip

- Contoured Finger Grooves for a Solid and Repeatable Grip
- Symmetrically Shaped Palm Swell with Nonslip Texture
- Removable End Cap with Storage Compartment within Foregrip
- Molded from Impact Resistant Polymer



Item # (Model)	RB-FGRP170B	RB-FGRP170D	RB-FGRP168B	RB-FGRP172B
Operation	Foldable		Fixed	
Color	Black	FDE	Black	Black
Length	1.57"		1.70"	2.25"
Saddle Height	5.60"		5.37"	4.50"
Weight	6.90oz		6.80oz	6oz



# AR15 PISTOL GRIPS

Item # (Model)	RBUPG01B	RBUPG01D	RBUPG02B	RBUPG02D
Color	Black	FDE	Black	FDE
Material	Polymer			
Height	4.60"		4.83"	
Weight	3.70oz		3.06oz	

Item # (Model)	RB-TPG172B	RB-TPG172D	RB-TPG269B	RB-TPG269G
Color	Black	FDE	Black	OD Green
Material	Polymer with Rubberized Coating			
Height	4.83"		4.60"	
Weight	5.10oz		4.80oz	4.70oz

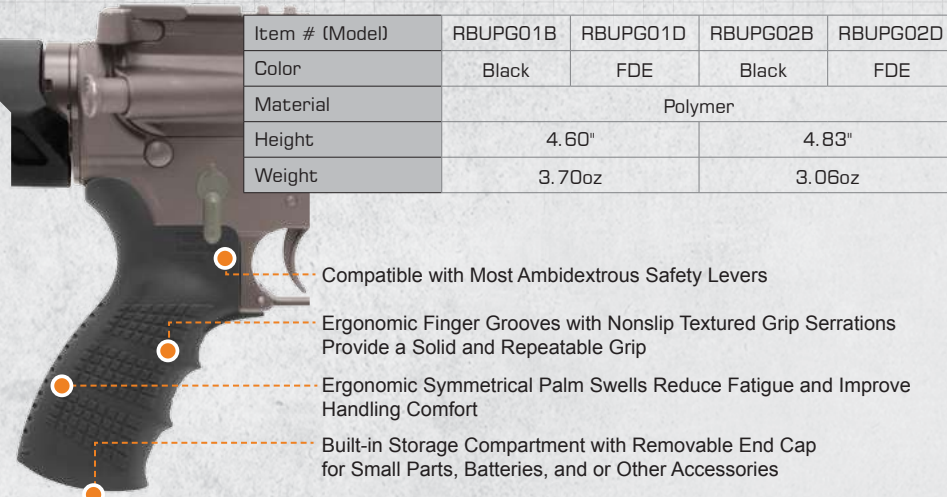

Compatible with Most Ambidextrous Safety Levers

Ergonomic Finger Grooves with Nonslip Textured Grip Serrations Provide a Solid and Repeatable Grip

Ergonomic Symmetrical Palm Swells Reduce Fatigue and Improve Handling Comfort

Built-in Storage Compartment with Removable End Cap for Small Parts, Batteries, and or Other Accessories

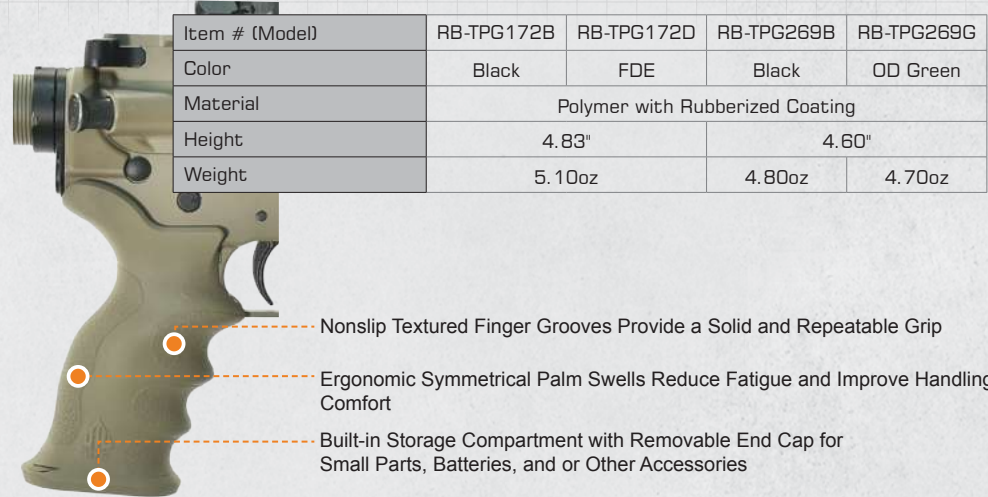

Nonslip Textured Finger Grooves Provide a Solid and Repeatable Grip

Ergonomic Symmetrical Palm Swells Reduce Fatigue and Improve Handling Comfort

Built-in Storage Compartment with Removable End Cap for Small Parts, Batteries, and or Other Accessories



**AMBIDEXTROUS**  
Compatible with  
Ambi Safeties



**AMBIDEXTROUS**  
Compatible with  
Ambi Safeties



**RIGHT HAND**



**RIGHT HAND**



BLACK RBUPG01B  
FDE RBUPG01D

**Ambidextrous Contoured  
Pistol Grip**

BLACK RBUPG02B  
FDE RBUPG02D

**Ambidextrous Pistol Grip**

BLACK RB-TPG172B  
FDE RB-TPG172D

**Combat Sniper Pistol Grip**

BLACK RB-TPG269B  
OD GREEN RB-TPG269G

**Ergonomic Pistol Grip**



# RAIL PANEL COVERS

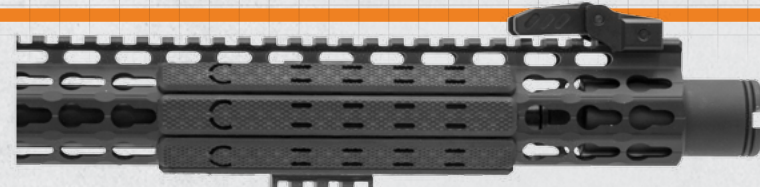

RB-HP25B (Set of 7)

## Low Profile Keymod Rail Panel Covers

- 5.5" in Length, Slim, Lightweight, and Securely Fits Into Standard Keymod Rail Slots
- Unique Aggressive Honeycomb Nonslip Textured Design Provides a Sure Grip Every Time
- Heat Resistant Polymer Construction

US PAT. 9989328



Bidirectional to Accommodate Installation around Other Mounted Accessories



Simple and Secure Slide and Snap-on Installation



RB-HP30M (Set of 4)

## Low Profile M-LOK® Rail Panel Covers

**NEW**

- 3.15" in Length, Slim, lightweight, and Securely Installs via Two M-LOK® Screws and Nuts
- Unique Aggressive Nonslip Textured Design Provides a Sure Grip Every Time
- Molded from Durable Impact and Heat Resistant Polymer with a Rubberized Overmold for Added Grip Traction



Bidirectional to Accommodate Installation around Other Mounted Accessories

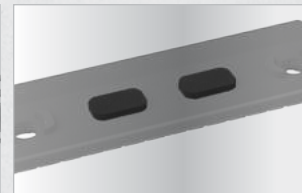

Simple and Secure Installation

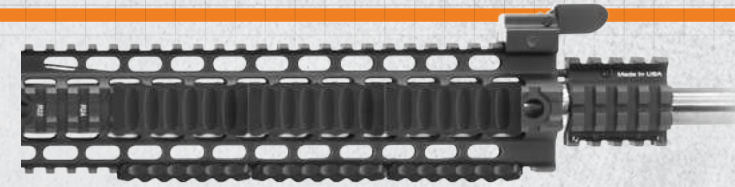

RB-HP27B (Set of 6)

## Low Profile Picatinny Panel Covers

- Molded from Durable Impact and Heat Resistant Polymer
- 2.7" in Length, Slim, Lightweight, and Securely Fits into Any Picatinny Rail
- Unique Scalloped Design Provides a Comfortable Nonslip Gripping Surface While Protecting the Rail Underneath it
- 6 Panels Per Pack, Matte Black



2.7" in Length, Slim, Lightweight, and Securely Fits into Any Picatinny Rail



Simple and Secure Snap-on Installation with Posi-lock Stop Bar to Prevent Shifting



BLACK RB-HP12B-B  
OD GREEN RB-HP12G-B  
FLAT DARK EARTH RB-HP12D-B

US PAT. 6725594  
US PAT. D730474

## Low Profile Picatinny Rubber Rail Guard (Set of 12)

- Provides a More Comfortable Gripping Surface
- Easily Snaps onto Picatinny Rails Without Shifting due to Integral Stop Bar
- Protects the User from Sharp Rail Edges While Protecting the Rail Itself



2" in Length, Slim, Lightweight, and Securely Fits into Any Picatinny Rail



Simple and Secure Snap-on Installation with Posi-lock Stop Bar to Prevent Shifting





# AK STOCK KITS & RECEIVER ADAPTOR

## UTG PRO® AK Mil-spec Collapsible Stock Kits

- End Plate Castle Nut and Mil-spec Receiver Extension Tube (TLU001) Machined from Aircraft Aluminum with a Matte Black Finish
- Mil-Spec 6 Position Stock Constructed from Impact Resistant High Strength Polymer



RBU47KT01  
**With Gen I Standard Stock Height Adaptor**



RBU47KT02  
**With Gen II Elevated Stock Height Adaptor**



RBU47KT03  
**With Gen III Adjustable Stock Height Adaptor**



Complete with AK Stamped Receiver Adaptor with Adjustable Height up to 20mm (RBU47KT03)



TL-K7FAD01

## AK Side Folding Stock Adaptor

- Requires UTG AK Stock Adaptor (TL-A68747-AD1) for Conversion, Compatible with Most 4/6 Position AR15 Stocks and Extension Tubes
- Heavy Duty Steel Construction with a Matte Black Finish
- Increased Flexibility



# AK/SKS ACCESSORIES

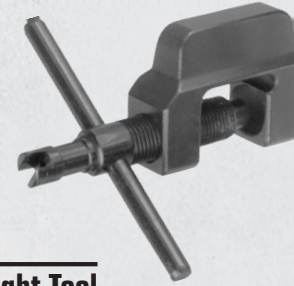

SCP-WEA05

## AK/SKS Front Sight Tool

- An Essential Tool for Making Fine Front Sight Post Windage and Elevation Adjustments
- Compatible with AK, SKS, MAK, and SLR95 Pattern Rifles



Elevation Adjustment



Windage Adjustment



TL-M47SR

## AK Precision Machined Steel Side Plate

- Fits Both Milled and Stamped Receivers and Accepts a Wide Variety of Side Optic Mounts
- Permanent Gunsmithing Required



TL-MGK702

## AK Dual Magazine Clamp

- High Strength Spring Steel Construction with a Matte Black Finish
- Fits Classic 7.62X39mm Magazines

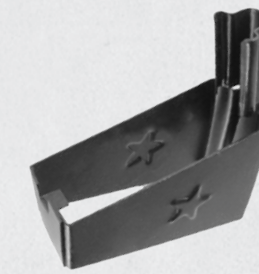
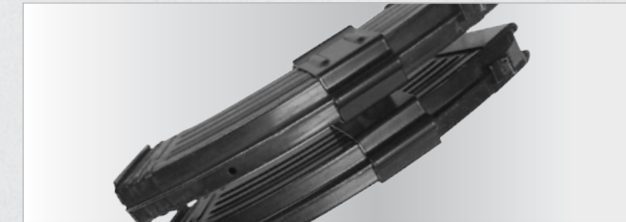

TL-K060

## AK/MAK Speed Loader

- Magazine Loader Fits AK or MAK-90 Magazines
- Speed Loads Using 7.62x39mm Stripper Clips



RB-K7BTP01

## AK Butt Pad

- Ergonomic Slip-on Design with Reinforced Outer Lip
- 1" LOP Extension



RB-TPG478B

## Ergonomic AK Pistol Grip

- Heavy Duty Polymer Construction with Rubberized Overmold
- Ergonomic Trigger Finger Swell Aids in Consistent Placement of Trigger Finger When Firing
- Storage Compartment with Removable End Cap





# QUICK DETACH SLING SWIVEL ADAPTORS & PLATES



BLACK TLUSW001  
FDE TLUSW001D



## UTG PRO® M-LOK® QD Sling Swivel Adaptor

- Precision Machined from 6061-T6 Aircraft Aluminum with a Matte Black Anodization or FDE CERAKOTE®
- Lightweight, Low Profile Design Requires Minimal M-LOK® Rail Space while Retaining Optimum Mount Performance
- Bidirectionally Mounts and Efficiently Utilizes Rail Real Estate by Mounting Either in One Slot or In-between Adjacent Slots on the Same Track
- Accepts Any Standard Quick Detach Sling Swivel with 0.37" Diameter Swivel Stud
- Designed with Quarter Turn Rotational Over Travel Stops to Restrict Swivel Movement and Prevent Sling Tangling



## UTG PRO® Keymod QD Sling Swivel Adaptor

- Precision Machined from 6061-T6 Aircraft Aluminum with a Matte Black Anodization
- Accepts Any Standard Quick Detach Sling Swivel with 0.37" Diameter Swivel Stud
- Designed with Quarter Turn Rotational Over Travel Stops to Restrict Swivel Movement and Prevent Sling Tangling



## Picatinny/Keymod QD Sling Swivel Adaptor

- Innovative, Compact, and Lightweight Design Adaptable for Installation on Both Picatinny or Keymod Rails
- Accepts Any Standard Quick Detach Sling Swivel with 0.37" Diameter Swivel Stud
- Precision Machined from Aircraft Aluminum with a Matte Black Finish

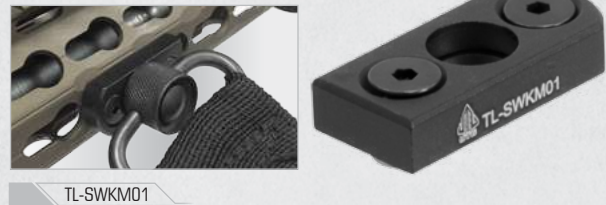

## Keymod QD Sling Swivel Adaptor

- Compact, Lightweight, Super Low Profile Keymod Base
- Accepts Any Standard Quick Detach Sling Swivel with 0.37" Diameter Swivel Stud
- Precision Machined from Aircraft Aluminum with a Matte Black Finish



## Low Profile Angled QD Sling Swivel Picatinny Adaptor

- Accepts Any Standard Quick Detach Sling Swivel with 0.37" Diameter Swivel Stud
- Precision Machined from Aircraft Aluminum with a Matte Black Finish
- Low Profile and Lightweight Design with 45 Degree Offset
- Designed with Quarter-turn Rotational Over Travel Stops to Restrict Swivel Movement and Prevent Sling Tangling



## AR15 QD Receiver End Plate

- Compatible with Standard Mil-spec AR15 Lower Receiver
- Solid Steel Construction with a Matte Black Finish
- Accepts Any Standard Quick Detach Sling Swivel with 0.37" Diameter Swivel Stud
- Designed with Quarter Turn Rotational Over Travel Stops to Restrict Swivel Movement and Prevent Binding Against the Buffer Tube and Sling Tangling

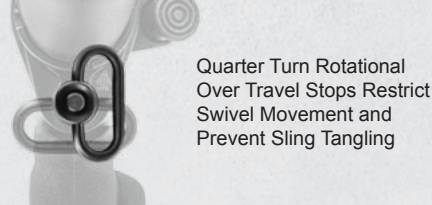

## AR15 Collapsible Stock Receiver End Plate

- Steel Construction with a Matte Black Finish
- Left and Right Sling Loops Accommodate Most Strap and Hook Type Sling Applications
- Compatible with both Mil-spec and Commercial-spec Receiver Extension Tubes



# QUICK DETACH SLING SWIVELS & SLING SWIVEL MOUNT



## Picatinny Sling Swivel Mount with 1.25" Loop

- Precision Machined Aircraft Aluminum and Steel Construction with a Matte Black Finish
- Solid Steel 1.25" Sling Loop Compatible with Most Slings on the Market

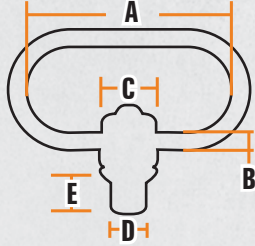

## Heavy Duty Push Button QD Sling Swivel with 1.38" Loop

- High Strength Steel Construction with a Matte Black Finish



## Standard Push Button QD Sling Swivel with 1.38" Loop

- High Strength Steel Construction with a Matte Black Finish



## Heavy Duty Push Button QD Sling Swivel with 1.38" Loop for 4mm Deep Housings

- High Strength Steel Construction with a Matte Black Finish
- Extended Ball Bearing Distance for Optimal Fit with 4mm Deep Housings
- Compatible with the Following UTG® and UTG PRO® Products: MTU001, MTU003, MTU007, MTU015, MTU018, MTU001T, MNT-BR005, MNT-BR101TR-A, MNT-BR002, MNT-BR005XL, and MNT-BR003XL



## Standard Push Button QD Sling Swivel with 1.09" Loop

- High Strength Steel Construction with a Matte Black Finish



## Standard Push Button QD Sling Swivel with 1.25" Loop

- High Strength Steel Construction with a Matte Black Finish



## Standard Push Button QD Sling Swivel with 1.29" C-Shape Loop

- High Strength Steel Construction with a Matte Black Finish



**NEW**  
TL-TRM01  
**M-LOK® Angled Index Mount**

- Precision Machined from 6061-T6 Aluminum and Finished in a Matte Black Anodization
- Provides an Additional Support Hand Indexing and Retention Point [Also Refer to P.148]



**NEW**  
MT-FGM01  
**M-LOK® Super Slim Foregrip**

- Aircraft Aluminum Finished in a Matte Black Anodization
- Removable Red and Blue Anodized Inserts Add a Level of Personalization [Also Refer to P.150]



**NEW**  
MT-AFGM01  
**M-LOK® Angled Foregrip**

- 6061-T6 Aluminum Construction Available in Matte Black, Blue, or Red Anodization
- Ergonomic Contour Improves Firearm Handling and Speeds Up Transitions [Also Refer to P.148]



**UTG PRO® M-LOK® Picatinny Rail Sections**

- Precision Machined from 6061-T6 Aircraft Aluminum with a Matte Black Anodization or FDE Cerakote® Finish
- Continuous Rail Edge Design for Optimal Accessory Attachment

Model #	Black	MTURS09S	MTURS09M
Slots		4	8
Other Available Colors		MTURS09SD	MTURS09MD
D=FDE			

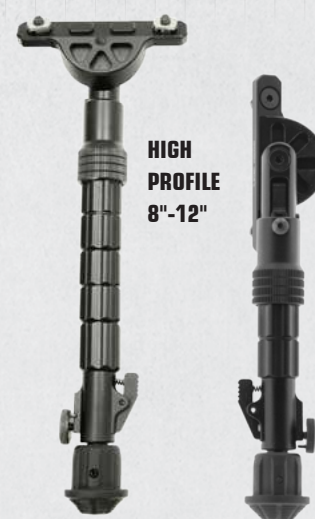
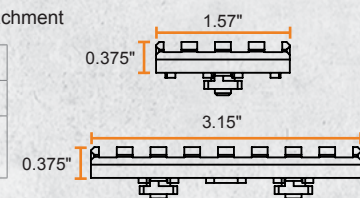

**NEW**  
PATENT PENDING  
HIGH PROFILE TL-BPDM02  
MEDIUM PROFILE TL-BPDM01  
**M-LOK® Recon Flex™ Bipod**

- Ergonomic Spring Loaded Slide Locking Ring for Quick and Effortless Bipod Deployment
- Lightweight Aircraft Aluminum Construction with a Matte Black Finish
- Fully Adjustable Legs with Precut Extendable Lengths and Flexible In-between Positions Lockable via Thumb Wheel [Also Refer to P.106]



**NEW**  
TL-HSM01  
**M-LOK® Ultra Slim Hand Stop**

- 6061-T6 Aluminum Construction Available in Matte Black, Blue, or Red Anodization
- Ergonomic Contour Improves Firearm Handling and Speeds Up Transitions [Also Refer to P.149]



**NEW**  
RB-HP30M (Set of 4)  
**M-LOK® Rail Panel Covers**

- 3.15" in Length, Slim, lightweight, and Securely Installs via Two M-LOK® Screws and Nuts
- Unique Aggressive Nonslip Textured Design Provides a Sure Grip Every Time
- Molded from Durable Impact and High Heat Resistant Polymer with a Rubberized Overmold for Added Grip Traction [Also Refer to P.153]



**IN-HOUSE Cerakote**  
BLACK TLUSW001  
FLAT DARK EARTH TLUSW001D  
**UTG PRO® M-LOK® QD Sling Swivel Adaptor**

- Precision Machined from 6061-T6 Aircraft Aluminum with a Matte Black Anodization or FDE Cerakote® Finish
- Lightweight, Low Profile Design Requires Minimal M-LOK® Rail Space while Retaining Optimum Mount Performance [Also Refer to P.156]



**NEW**  
RG-FL27MC  
**M-LOK® Offset Ring Mount**

- Removable Offset Mount Provides 1.60" Forward or Rearward Offset in addition to the Flashlight Ring's 1.12" Vertical or Downward Offset
- Complete with 2 Spacers to Accept 27mm, 25.4mm (1"), or 20mm Flashlight Tube Diameters [Also Refer to P.59]



**NEW**  
TL-HSK01  
**KeyMod Ultra Slim Hand Stop**

- 6061-T6 Aluminum Construction Available in Matte Black, Blue, or Red Anodization
- Ergonomic Contour Improves Firearm Handling and Speeds Up Transitions [Also Refer to P.149]

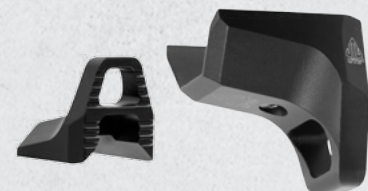

**NEW**  
TL-HS02B  
**KeyMod Hand Stop/Barricade Rest Kit**

- Promotes Proper Support Hand Memory Placement and Retention [Also Refer to P.149]



**UTG PRO® KeyMod Picatinny Rail Sections**

- Precision Machined from 6061-T6 Aircraft Aluminum with a Matte Black Anodization or Cerakote® Finish
- Continuous Rail Edge Design for Optimal Accessory Attachment

Model #	Black	MTURS04S	MTURS04M
Slots		4	8
Other Available Colors		MTURS04SD	MTURS04MD
D=FDE		MTURS04SG	MTURS04MG
G=OD Green		MTURS04SM	MTURS04MM
M=Gun Metal		MTURS04SZ	MTURS04MZ
Z=Burnt Bronze			



**NEW**  
MT-AFGK01  
**KeyMod Angled Foregrip**

- 6061-T6 Aluminum Construction Available in Matte Black, Blue, or Red Anodization
- Ergonomic Contour Improves Firearm Handling and Speeds Up Transitions [Also Refer to P.148]



**NEW**  
TL-TRK01  
**KeyMod Angled Index Mount**

- Precision Machined from 6061-T6 Aluminum and Finished in a Matte Black Anodization
- Provides an Additional Support Hand Indexing and Retention Point [Also Refer to P.148]



**NEW**  
MT-FGK01  
**KeyMod Super Slim Foregrip**

- Aircraft Aluminum Finished in a Matte Black Anodization
- Removable Red and Blue Anodized Inserts Add a Level of Personalization [Also Refer to P.148]



**NEW**  
PATENT PENDING  
HIGH PROFILE TL-BPDK02  
MEDIUM PROFILE TL-BPDK01  
**KeyMod Recon Flex™ Bipod**

- Ergonomic Spring Loaded Slide Locking Ring for Quick and Effortless Bipod Deployment
- Fully Adjustable Legs with Precut Extendable Lengths and Flexible In-between Positions Lockable via Thumb Wheel [Also Refer to P.106]



RB-HP25B (Set of 7)  
**Low Profile KeyMod Rail Panel Covers**

- Molded from Durable Impact Resistant Polymer
- 5.5" in Length, Slim, Lightweight, and Securely Fits into Standard KeyMod Rail Slots [Also Refer to P.153]

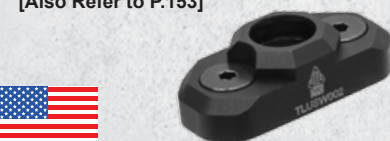

TLUSW002  
**UTG PRO® KeyMod QD Sling Swivel Adaptor**

- Precision Machined from 6061-T6 Aircraft Aluminum with a Matte Black Anodization or FDE Cerakote® Finish
- Low Profile, Lightweight, and Compact Design
- Bidirectionally Mounts to Most KeyMod Mounting Platforms [Also Refer to P.156]



TL-SWKM01  
**KeyMod QD Sling Swivel Adaptor**

- Precision Machined from Aircraft Aluminum with a Matte Black Finish [Also Refer to P.156]



RG-FL27KC  
**KeyMod Offset Low Profile Ring Mount**

- Removable Offset Mount Provides 1.60" Forward or Rearward Offset in addition to the Flashlight Ring's 1.12" Vertical or Downward Offset
- Complete with 2 Spacers to Accept 27mm, 25.4mm (1"), or 20mm Flashlight Tube Diameters [Also Refer to P.59]





# BROKEN SHELL EXTRACTORS & OTHER ACCESSORIES



TL-EX223  
**.223/5.56 Broken Shell Extractor**

TL-S001  
**7.62X39 Broken Shell Extractor**

TL-EX308  
**.308 Broken Shell Extractor**



## Broken Shell Extractor

- Removes Broken Shell Casings from a Jammed Chamber
- Threaded Two-piece Design to Adjust Overall Length, Compatible with Bolt Action and Semi-automatic Rifles
- Precision Machined from Steel
- Keep One with Your Shooting Gear, in Your Tool Kit, or Gun Case



## California DOJ Approved Firearm Cable Lock

- Certified by California Department of Justice
- Universal Design Compatible with Most Long Guns and Pistols
- Locking Cable is 0.21"(5.3mm) in Diameter and 15"(381mm) in Length
- Plastic Wrap Prevents Cable from Scratching Firearm Finishes



## Universal Shotgun Forend Wrench

- Nickel Plated Steel Construction
- User Friendly with Ergonomic Handles for Easy Forend Removal and Installation
- Compatible with Remington® 870™, Mossberg® 500A/C, 835, and Other Clones



## Chamber Safety Flag

- Bright Orange for High Visibility and Reliable Confirmation of an Unloaded Firearm
- Molded from Impact Resistant Polymer with Reinforced Head for Maximum Durability
- Ideal for Cold Range Use and Mass Produced Firearms



## AR15 Receiver Wedge

- Snugly Fits Behind Rear Take Down Pin
- Keeps the Upper Snug and Tight Against the Lower
- Prevents Upper and Lower Receiver Rattle

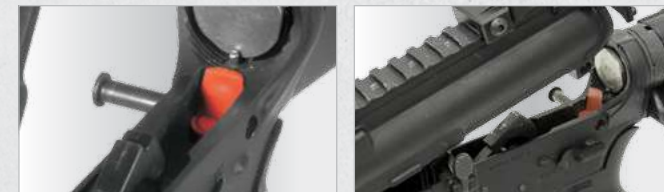

Reliably Proven and Exceeds MILITARY STANDARDS with Tens of Thousands Sold

MNT-16AD1-C  
**For AR15 Rifle**

MNT-16AD2-C  
**For AR15 Carbine**

## AR15 Blank Firing Adaptor

- Precision Machined High Strength Steel Construction
- Color Coated for Protection and Discernibility
- Reinforced Frame Surpasses Military Standards
- Ideal for Law Enforcement and Military Training
- User Friendly Bolt Ring for Simple Installation and Removal



# CLEANING KITS



## .223/5.56mm Cleaning Kit

- Includes a 5-piece Extension Steel Cleaning Rod with Adaptor, Patch Loop, Bronze Bore Brush, Chamber Brush, Double-Ended Nylon Utility Brush, ½ oz Oil Bottle, and Cleaning Patches
- All Parts Conveniently Store within the Included OD Green Nylon Pouch with Belt Loop and ALICE Clip Attachment Point and Featuring Two Hook-and-loop Closure Pockets and External Snap Button Flap



## 9mm Pistol Cleaning Kit

- Conveniently Stows Away in Any Range Bag in Its Compact Polymer Case (4.63"x2.88"x1.50")
- Kit Includes an 8-32 Threaded Copper Alloy Cleaning Rod with the Following Threaded Cleaning Accessories: Patch Loop, Bronze and Nylon Brush, and a Cotton Mop

## Universal Firearm Cleaning Mat

- 14.75"x52" Universal Firearm Cleaning Mat with Nonslip Rubberized Backing
- 4" Wide Side Pocket with Zipper Closure for Cleaning Tools and Small Parts
- Durable Solvent and Chemical Resistant Material for Long Lasting Performance [Also Refer to P.191]





## INTRODUCTION

Leapers UTG does not just stop at providing customers with the most practically innovative products on the market, but continues forward in improving our existing product lines to meet the new modern requirements of today's shooting standards. Our gun cases are constructed using exceptionally durable and water resistant materials; feature reinforced stitching at key points, and come complete with reliable hardware and zippers while still being an exceptional value to our customers. Rugged in construction and over-engineered by design, Leapers UTG gun cases thwart off the rigors of rough terrains, environments, and inclement weather, protecting your firearms and accessories and keeping them ready the instant you need them. We take great pride in providing our customers with total solutions applicable to their needs, lifestyles, and hobbies. New for 2019 is a new addition to our well received discreet shoulder ABC sling packs. This new model, designed specifically for law enforcement with their direct input, focuses on the increasing need and popularity of officers to carry patrol rifles in public, on their person, and not just in their vehicles. A more streamlined design and improved quick deployment and extended carry ergonomics are just some of its new features. Whether military, law enforcement, or the everyday recreational shooter, Leapers UTG has the most complete product line with the best value.

**LEAPERS, INC.**  
**THE BEST NEVER REST**  
**LIFETIME WARRANTY**

## ABSOLUTE COMMITMENT TO QUALITY



Rugged Materials



Weather Proof Coatings



Intelligent Storage Capability



Durable Hardware



Protective Padding



Comfortable Carry

**UTG** **GUN CASES**  
**FOR LONG GUNS AND PISTOLS**

### NEW AND MUST HAVE PRODUCTS FOR 2019



### HOMELAND SECURITY GUN CASES



### COMPETITION SHOOTER'S DOUBLE PISTOL CASE





# ABC SERIES - ALPHA BATTLE CARRIER SLING PACKS

DISCREET AND SPORTERIZED CARRY OF YOUR FIREARMS

- RUGGED MATERIALS
- WEATHER PROOF COATINGS
- DIVERSE STORAGE CAPABILITY
- QUICK DEPLOYMENT
- PADDED INTERIOR
- LEFT/RIGHT REVERSIBLE
- LOCKABLE ZIPPER
- AVAILABLE COLORS

- FDE
- BLACK/NAVY
- BLACK/GREY
- BLACK

New for 2019 is a new addition to our well received discreet shoulder ABC sling packs. This new model, designed specifically for law enforcement with their direct input, focuses on the increasing need for officers to carry patrol rifles in public, on their person, and not just in their vehicles. A more streamlined design, improved quick deployment and extended carry ergonomics are just some of its new features.

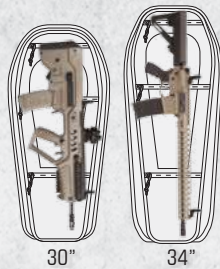

Model#	PVC-PSP34B	PVC-PSP30BN	PVC-PSP34BN	PVC-PSP34BG	PVC-PSP34S
Dimensions	34"x15"	30"x12"	34"x13"	34"x13"	34"x13"
Material	Polyester				
Density	900D				
Color	Black	Black/Navy	Black/Navy	Black/Grey	Flat Dark Earth



**NEW**

PVC-PSP34B  
34 Inch

## Quick Pull & Deployment



## Carry Options



Reversible shoulder carry

Horizontal Carry

## PSP30BN/34BN/34BG/34S ONLY



- Discreet and Inconspicuous Styling and Color Scheme Appearance
- Universal Pistol Holster
- Large Accessories Pocket
- Padded Barrel Catch Keep Muzzles Secure and Protected during Transportation
- Removable Padded Center Divider
- Dual #10 Heavy Duty Lockable Zippers
- Fully Adjustable Hook-and-loop Retention Strap

- Adjustable Padded Shoulder Strap
- MOLLE Straps
- Carry Handle
- Quick Detach Buckle
- Reversible QD Retention Strap and Buckle Prevents Pack from Shifting While Slung on Back
- Quick Deployment Pull Handle

**NEW**



PVC-PSP34B  
34 Inch



PVC-PSP34BN  
34 Inch



PVC-PSP34BG  
34 Inch



PVC-PSP34S  
34 Inch



PVC-PSP30BN  
30 Inch



# MC SERIES - HOMELAND SECURITY GUN CASES

- RUGGED MATERIALS
- WEATHER PROOF COATINGS
- DIVERSE STORAGE CAPABILITY
- DURABLE HARDWARE
- PADDED INTERIOR
- COMFORTABLE CARRY
- LOCKABLE ZIPPER
- AVAILABLE COLORS

- BLACK
- BLACK/GRAY



PVC-MC42B  
**42 Inch**

PVC-MC34B  
**34 Inch**

PVC-MC32B  
**32 Inch**

Model#	PVC-MC42B	PVC-MC34B	PVC-MC32B
Dimensions	42"x13"	34"x12"	32"x12"
Material	Polyester		
Density	600D		
Color	Black/Gray	Black	



# KIS 38" GUN CASE KEEP-IT-SIMPLE



**32 INCH/34 INCH ONLY**

**42 INCH ONLY**



- PVC-KIS38B2  
**KIS 38" Gun Case**
- Hook-and-loop Pocket
  - Name Tag Holder
  - Zippered Pocket
  - Fully Padded Interior
  - Wall Hanger D-rings
  - Adjustable Shoulder Strap
  - Dual #8 Heavy Duty Lockable Zippers
  - Two-piece Carry Handle

Model#	PVC-KIS38B2
Dimensions	38" x 12.5"
Material	Polyester
Density	600D
Color	Black



# DC SERIES - TACTICAL GUN CASES

- RUGGED MATERIALS
- WEATHER PROOF COATINGS
- DIVERSE STORAGE CAPABILITY
- DURABLE HARDWARE
- PROTECTIVE PADDING
- COMFORTABLE CARRY
- LOCKABLE ZIPPER
- AVAILABLE COLORS

- BLACK
- ARMY DIGITAL



PVC-DC42B-A  
42 Inch

PVC-DC38B-A  
38 Inch

PVC-DC38R-A  
38 Inch

PVC-DC34B-A  
34 Inch

Model#	PVC-DC42B-A	PVC-DC38B-A	PVC-DC38R-A	PVC-DC34B-A
Dimensions	42" X 13"	38" X 12.5"	38" X 12.5"	34" X 12"
Material	Polyester			
Density	900D			
Color	Black	Black	Army Digital	Black



# RC COMBAT OPERATION WEB CASE

- RUGGED MATERIALS
- WEATHER PROOF COATINGS
- DIVERSE STORAGE CAPABILITY
- DURABLE HARDWARE
- PROTECTIVE PADDING
- COMFORTABLE CARRY
- LOCKABLE ZIPPER
- AVAILABLE COLOR

- BLACK



PVC-RC42B-A  
42 Inch

Model#	PVC-RC42B-A
Dimensions	42"x13"
Material	Polyester
Density	900D
Color	Black



# COMPETITION SHOOTER'S DOUBLE PISTOL CASE

- RUGGED MATERIALS
- WEATHER PROOF COATINGS
- DIVERSE STORAGE CAPABILITY
- DURABLE HARDWARE
- PROTECTIVE PADDING
- COMFORTABLE CARRY
- LOCKABLE ZIPPER
- AVAILABLE COLOR

BLACK

Model#	PVC-PC05B
Dimensions	11.5" X 9.5"
Material	Polyester
Density	900D
Color	Black



# DELUXE PISTOL CASES



PVC-PC01B

### Single Pistol Case

- Premium 1680D Polyester Material
- Fully Padded Interior
- Premium #10 Lockable Zippers
- 5 Universal Magazine Pouches
- Additional Outer Accessory Pocket

PVC-PC02B

### Double Pistol Case

- Premium 1680D Polyester Material
- Fully Padded Interior
- Premium #10 Lockable Zippers
- 6 Universal Magazine Pouches
- Additional Outer Accessory Pocket

PVC-PC03G

### Armorer's Tool Case

- Fully Padded Interior
- Premium Lockable #10 Lockable Zippers
- Additional Outer Pocket for Quick Access to Frequently Used Tools and Accessories
- Multiple Individual Pockets of Various Sizes for Easy Organization of Tools and Accessories

PVC-PC380

### Discreet Handgun Case

- For Pocket/Sub-compact Pistols/Revolvers
- Reinforced Front and Back Panels for Improved Durability and Shape Integrity
- Dual #8 Heavy Duty Lockable Zippers

Model #	PVC-PC01B	PVC-PC02B	PVC-PC03G	PVC-PC380
Dimensions	11" X 8"	13" X 8"	12" X 8"	5" X 7"
Material	Polyester			
Density	1680D	1680D	600D	1680D
Color	Black	Black	OD Green	Black



## INTRODUCTION

Leapers UTG® is proud to present our extensive product line of shooting sports oriented hard use gear. Confident in our thoughtful design and precise execution, we encourage professional and recreational shooters alike to view our wide selection of products suitable for all different walks of life. We trust that you will find some of the most practical features, rich and well thought-out for the lifestyle you live by through the day and come home from by night. Our attention to detail makes all the difference. Quality materials, reinforced stress points, dual and thick gauge stitching, modularity, optimized ergonomics, and full adjustability to fit many body types are just some of the welcoming aspects you will discover within the following pages. From hunting and tactical vests to bags, packs, holsters, slings, and belts our hard use gear is the result of continuous product improvements with direct input from professional, competitive, and civilian shooters. It is the feedback of our loyal customers that drives our unflinching commitment to providing shooting sports oriented hard use gear that not only satisfies, but perseveres.

## HARD USE GEAR THAT PERSEVERES



Bags and Packs



Vests



Slings



Holsters



Concealed Carry



Range Gear

**LEAPERS, INC.**  
**THE BEST NEVER REST**  
**LIFETIME WARRANTY**

### NEW AND MUST HAVE PRODUCTS FOR 2019

BOLLATM 2 TO 1 POINT  
 CONVERSION SLING

**NEW**



OVERBOUND PACK



9-2-5 BRIEFCASE



V547 LAW ENFORCEMENT VESTS



HOLSTERS



DELUXE MESH SHELL CATCHER



**UTG** **TACTICAL GEAR**  
 BAGS, PACKS, VESTS, HOLSTERS, AND MORE

- RUGGED MATERIALS
- WEATHER PROOF COATINGS
- DIVERSE STORAGE CAPABILITY
- DURABLE HARDWARE
- PROTECTIVE PADDING
- COMFORTABLE CARRY
- AVAILABLE COLOR

■ BLACK

Model#	PVC-P836B
Length/Width/Height	12"x6"x18"
Material	Polyester
Density	1200D
Color	Black



MOLLE Webbing



Overbound Pack

Hook-and-loop Patch



Zippered Side Wall Pockets



Zippered Mesh Pockets



Ergonomic Fully Adjustable Shoulder Straps with Chest Strap for Added Retention

Thickly Padded, Breathable, Back Panel for Comfortable Carry and Back Support

Hook-and-loop Luggage Strap



Front Compartment with Multiple Storage Pockets

Carry Handle

Top Pocket Storage with Buckle Attached Rain Cover



Upper Zippered Front Pocket with Internal Storage Pockets

Lower Front Zippered Pocket



Left and Right Side Pockets with Elastic Closure

Spacious Rear Compartment with Hook-and-loop Backing

- RUGGED MATERIALS
- WEATHER PROOF COATINGS
- DIVERSE STORAGE CAPABILITY
- DURABLE HARDWARE
- PROTECTIVE PADDING
- COMFORTABLE CARRY
- AVAILABLE COLOR

■ BLACK

Model#	PVC-P925B
Length/Width/Height	16"x4"x12"
Material	Polyester
Density	1200D
Color	Black



1. Main Compartment with Removable Laptop Pouch



2. Concealed Zippered Pocket with Hook-and-loop Panel Complete with Universal Pistol Holster



3. Smaller Internal Pockets Great



4. Padded Pouch Compatible with 15" Tablet/Laptop



9-2-5 Briefcase

MOLLE Webbing

Carry Handle

Nonslip Shoulder Strap with Elastic Strap Pocket



Ambidextrous



Multiple Storage Compartments for Documents and Laptop Accessories

Name Tag Holder



6



7

Laptop Pouch

Briefcase

5. Rear Facing Pockets

6. Outer Side Wall Pockets

7. Hook-and-loop Luggage Strap

8. D-rings for Carrying Laptop Pouch Separately Using Included Shoulder Strap





# SITUATIONAL PREPAREDNESS PACKS

- RUGGED MATERIALS
- WEATHER PROOF COATINGS
- DIVERSE STORAGE CAPABILITY
- DURABLE HARDWARE
- PROTECTIVE PADDING
- COMFORTABLE CARRY
- AVAILABLE COLOR

BLACK

### Universal Features



Grab and Go Carry Handle

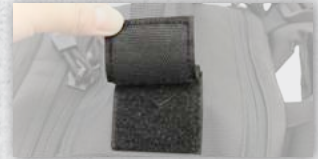

Headphone Ports



Luggage Strap Securely Attaches to Most Collapsible Luggage Handles

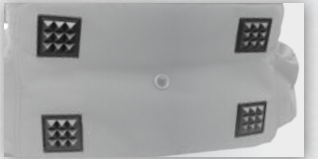

Thickly Padded Bottom with Rubber Foot Pads



Adjustable Buckle Straps Provide an Extra Layer of Security Around the Pack



1-Day  
Concealed Left and Right Side Pockets



2-Day/3-Day  
Left and Right Side Pockets with MOLLE Webbing



3-Day  
Generous Middle Compartment



2-Day/3-Day  
Adjustable Waist Strap with QD Buckle System



2-Day/3-Day  
Top Storage Pocket with Buckle Attached Rain Cover



PVC-P124B  
1 Day Pack



PVC-P248B  
2 Day Pack



PVC-P372B  
3 Day Pack



### 1-Day/2-Day UPPER ZIPPERED FRONT POCKET

- Two Outer Rows of MOLLE Webbing with Hook-and-loop Patch

### LOWER ZIPPERED FRONT POCKET

- Four Outer Rows of Additional MOLLE Webbing



### 1-Day/2-Day/3-Day FRONT COMPARTMENT

- Multiple Storage Pockets and Organized Layout



### 1-Day/2-Day/3-Day MAIN COMPARTMENT

- 11" x 5" x 17" Main Compartment Provides Ample Space and features a Thickly Padded Pocket with Hook-and-loop Closure for a 15" Laptop
- Two Zippered Side Wall Pockets Complement the Compartment, Maximizing the Use of Available Space while Still Maintaining an Organized Layout
- The accompanying inner side to the pack's cover features an additional 3 zippered pockets, two of which are mesh

### SIDE POCKETS

- Concealment and or dedicated pockets for carrying water bottles, insulated bottles, compact umbrellas, and more featuring zippered closures and MOLLE Webbing

### WEARABLE ERGONOMICS

- Ergonomically shaped shoulder straps are padded thick for comfort, fully adjustable, and are contoured to better fit a person's shoulder, chest, and waist geometry
- A quick release buckle chest and or waist strap provides an additional retention point around the body if needed

### PADDED BACK

- Thickly padded back panels reduce strain and fatigue when carried for an extended period of time while allowing for air flow and ventilation
- Convenient luggage strap wraps securely around luggage handles

Model#	PVC-P124B	PVC-P248B	PVC-P372B	PVC-SP247B
Length/Width/Height	11"x7.50"x17"	15.50"x9"x19"	16.50"x10"x20"	10"x5.50"x17"
Material	Polyester			Polyester
Density	1200D			1200D
Color	Black			Black



# VITAL SLING PACK

PVC-SP247B

- Adjustable Buckle Straps Provide an Extra Layer of Retention Around the Pack
- Upper Front Pocket with Internal Storage Pockets
- Quick Access Side Wall Pockets
- Lower Front Pocket with Internal Storage Pockets
- MOLLE Webbing Allows the Attachment of Additional Accessories
- Fleece-lined Top Pocket for Eyewear
- Ambidextrous Padded Shoulder Strap
- Thickly Padded, and Breathable Back Panel
- Spacious Rear Compartment
- Additional MOLLE Webbing
- Ambidextrous QD Retention Strap to Increase Stability During Carry
- Large Capacity Main Pocket
- Side Wall Pockets
- Mesh Pockets
- Carry Handle
- Miscellaneous Elastic Loops
- Front Compartment with Multiple Pockets and Organized Layout



Ambidextrous





# ALL-IN-ONE RANGE/UTILITY GO BAGS

## HEAVY DUTY MULTI-USE GO BAGS

- RUGGED MATERIALS
- WEATHER PROOF COATINGS
- DIVERSE STORAGE CAPABILITY
- DURABLE HARDWARE
- PROTECTIVE PADDING
- COMFORTABLE CARRY
- AVAILABLE COLORS

- BLACK
- BLACK/CRIMSON
- BLACK/VIOLET
- BLACK/SILVER

### All-in-one Range/Utility Go Bags

- Ample Storage Capacity and Unique Layout Designed to Meet Different Application Demands for Simple Organization, Versatile Use, and Comfortable Carry
- Two Padded Front Pockets with MOLLE Webbing
- Open Top with Clear Zippered Pocket and Dual Zipper Closure
- Large Capacity Main Compartment with 2 Inside Wall Pockets
- Removable Dividers, 2 Pistol Cases, and 1 Brass Bag Included
- Fully Adjustable Shoulder Strap with D-ring Pull and Nonslip Grip Texture
- Reinforced Wraparound Carry Handles
- Thickly Padded Bottom with Rubber Foot Pads



Zippered Side Pocket for Ammunition, Magazines, and Other Accessories

Multiple Storage Compartments Perfect for Hearing/Eye Protection, Mags, Ammo, Targets, First Aid, Cleaning Supplies, and Much More

Removable Pistol Cases, and Brass Bag included; Perfect for Competition and Recreation



Fully Adjustable Shoulder Strap with Delta Plate and Nonslip Grip Texture



Zippered Side Pocket and Retention Adjustable Water Bottle Pouch



Open Top with Dual Lockable Zipper Closure (PVC-P365B Only)



PVC-P365B



PVC-P365BC



PVC-P365BV



PVC-P768BM

### All-In-One Range Bag

- Designed to Meet Different Application Needs for Easy Organization, Versatile Use, and Comfortable Carry
- Zippered Pocket with Detachable Cleaning Mat and 8 Elastic Pistol Mag Pouches
- Outer Zippered Pocket with MOLLE Webbing
- Large Capacity Main Compartment with 2 Inside Wall Pockets
- Removable Caddy with Adjustable Dividers, Equipped with Handles and Shoulder Strap for Separate Transportation, Includes 2 Brass Bags
- Tough PVC Coated Material, Reinforced Stitching, Heavy Duty Zippers, and Well Padded Pockets to Protect and Organize All Your Essential Gear



Two Zippered Side Pockets with ID Holders, and a Retention Adjustable Water Bottle Pouch



Fully Adjustable Padded Shoulder Strap and Reinforced Wraparound Carry Handles



Easily Accessible Large Padded Front Pockets



Open Top with Dual Zipper Closure

Detachable Cleaning Mat



Removable Pistol Cases, Brass Bags, and Caddy Equipped with Adjustable Dividers; Perfect for Competition and Shooting on the Move



PVC-P807A  
PVC-P807B

### Ranger Field Bags

- Durable 600D Polyester Construction with Water Resistant Inner Lining
- Features Two Zippered End Pockets and Hook-and-loop Side Pockets, a Dedicated Internal Map/Document Pocket, and a Hook-and-loop Bordered Name Tag Holder
- Dual #10 Heavy Duty Zippers and Three Quick Release Retention Straps Keep the Pack Secure During Transportation
- Additional Padding Towards the Top of the Bag Provides Added Comfort to the Head and Neck Region When Carried on the Back
- Integral Storm Flap and Water Resistant Construction Keeps Your Gear Dry
- Thickly Padded Adjustable Shoulder Straps
- Wraparound Carry Handle
- Rubber Foot Pads Prevents the Bottom of the Pack from Abrasion

Model#	PVC-P365B	PVC-P365BC	PVC-P365BV	PVC-P768BM	PVC-P807B	PVC-P807A
Length/Width/Height	21"x9"x8"			23"x16"x8"		36"x12"x12"
Material	Polyester					
Density	600D			900D		600D
Color	Black	Black/Crimson	Black/Violet	Black/Silver	Black	Army Digital



# TRUE HUNTER™ & TRUE HUNTRESS® SPORTING VESTS

COMFORTABLE WEAR FOR HUNTING, SHOOTING, AND OUTDOOR ACTIVITIES

- RUGGED MATERIALS
- WEATHER PROOF COATINGS
- DIVERSE STORAGE CAPABILITY
- DURABLE HARDWARE
- PROTECTIVE PADDING
- AVAILABLE COLORS

- BLACK
- GREY/BLACK
- BLAZE ORANGE/BLACK
- GREY/BLUE
- GREY/PINK
- BLACK/PINK



Model#	True Hunter™ Vests					True Huntress® Vests						
	PVC-VM32BB	PVC-VM36BB	PVC-VM36GB	PVC-VM32OB	PVC-VM36OB	PVC-VF18BB	PVC-VF21BB	PVC-VF24BB	PVC-VF21GP	PVC-VF21OB	PVC-VF21BP	PVC-VF21GB
Length	27"	28.50"	28.50"	27"	28.50"	25"	26"	28"	26"	26"	26"	26"
Adjustable Girth	39" - 50"	46" - 56"	46" - 56"	39" - 50"	46" - 56"	34" - 44"	36" - 54"	44" - 56"	36" - 54"	36" - 54"	36" - 54"	36" - 54"
Material	Polyester											
Density	600D											
Color	Black	Black	Gray/Black	Blaze Orange/Black	Blaze Orange/Black	Black	Black	Black	Gray/Pink	Blaze Orange/Black	Black/Pink	Gray/Blue

True Hunter™ Vests



True Huntress® Vests



TACTICAL GEAR

SPORTING VESTS

TACTICAL GEAR

SPORTING VESTS



# TACTICAL VESTS

## PRACTICAL FEATURES & OPTIMIZED LAYOUTS

- RUGGED MATERIALS
- WEATHER PROOF COATINGS
- DIVERSE STORAGE CAPABILITY
- DURABLE HARDWARE
- PROTECTIVE PADDING
- AVAILABLE COLORS

- BLACK
- OD GREEN
- ARMY DIGITAL



Left Handed



PVC-V547BL



PVC-V547BT



PVC-V547GT



PVC-V547RT



Large ID Pouch with Removable Shot Shell Holder

Recoil Shoulder Guard

Radio Pouch

3 Universal Pistol Mag Pouches

Detachable Crossdraw Holster Interchangeable with Included Double Rifle Magazine Pouch

High Quality #10 Zippers

4 Rifle Mag Pouches (3 Right, 1 Left) with Elastic Retention and Hook-and-loop Closure

Pistol Belt with Horizontal Pistol Mag Pouches



Reinforced Rescue Drag Handle

Breathable Mesh

One Size Fits Most with Straps Adjustable in Girth up to a 54" Waist

Back Loop Accessories Panel



1

2

3

4

5

6

7



8

10

PVC-V548BL

### Law Enforcement SWAT Vest

- Elastic Rifle Cartridge Holder
- Radio Pouch
- Large ID Pouch with Elastic Shot Shell Holder
- 2 Universal Pistol Mag Pouches
- Rifle Mag Pouch with Elastic Retention
- 2 Large Pouches
- Thumb Break Pistol Holster
- Rear Hook-and-loop Panel
- Large Rear Miscellaneous Pouch
- Elastic Cords to Adjust Vest Girth
- One Side Fits Most with Length and Girth Adjustability



1

2

3

4

5

6

7

8



9

10

11

PVC-V747KTB

### 10 Piece Complete Web Vest & Drop Leg Platform Kits

- Flashlight Pouch with Hook-and-loop and Buckle Secured Closure
- Radio Pouch with Dual Zippered Compartment and Buckle Secured Closure
- Open Top AR15 Mag Pouches with Retention Cords
- Dual Double Stack Pistol Mag Pouch with Hook-and-loop Closure
- Medical/Utility Pouch with Removable Trauma Mesh Bags, Utility Loops, and Dual Zipper Closure
- Heavy Duty Belt Adjustable from 44" - 52"
- Drop Leg Molly Platform with Detachable Ambidextrous Pistol Holster
- Drop Leg Molly Platform with Detachable Dump Pouch
- Reinforced Rescue Drag Handle
- Molly Back Panel
- One Side Fits Most with Length and Girth Adjustability

Model#	PVC-V547BT	PVC-V547BL	PVC-V547GT	PVC-V547RT	PVC-V548BL	PVC-V747KTB
Adjustable Height	22" - 25"	22" - 25"	22" - 25"	22" - 25"	21" - 23"	21" - 23"
Adjustable Girth	40" - 54"	40" - 54"	40" - 54"	40" - 54"	40" - 54"	38" - 55"
Adjustable Belt Length	44" - 52"	44" - 52"	44" - 52"	44" - 52"	N/A	44" - 52"
Material	Polyester					
Density	1680D			900D		600D
Color	Black	Black	OD Green	Army Digital	Black	Black
Handedness	Right Handed	Left Handed	Right Handed	Right Handed	Right Handed	Right Handed



PVC-GB508B **NEW**  
**BOLLA™ 2 To 1 Point Conversion Sling**



Rifle is Tight Against the Body with Slider Rearward



Ambidextrous QD Sling Swivel Housing  
Convert Sling to 1 Point Configuration



Features Reinforced QD Sling Swivel



Adjustment Slider Quickly Transitions rifle from Rest to Ready Position



Adjustment Slider Quickly Transitions rifle from Rest to Ready Position

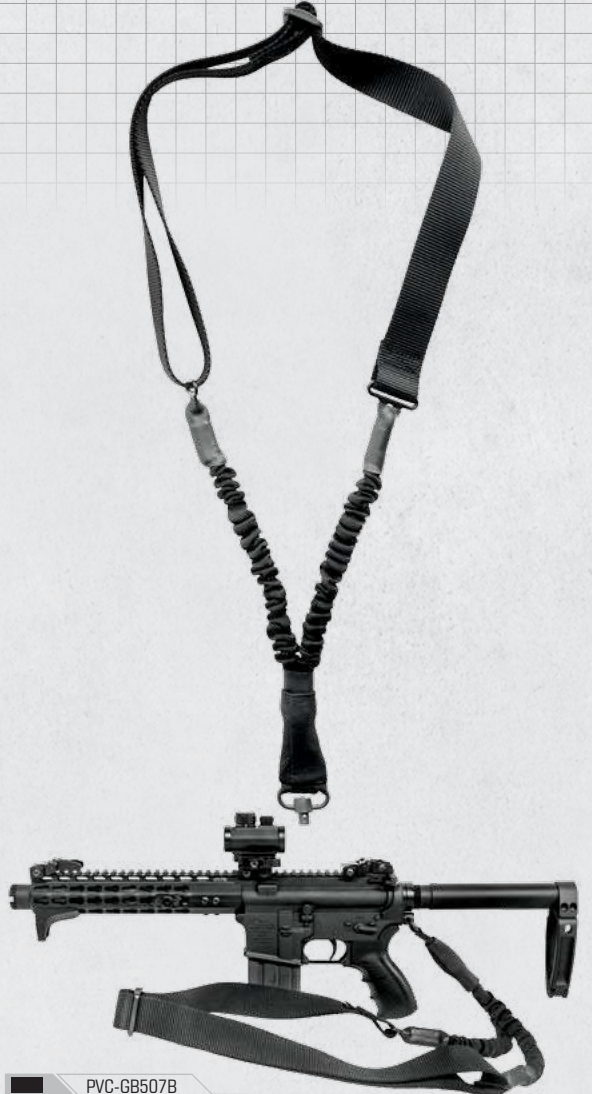

PVC-GB507B  
**QD Sling Swivel Single Point Bungee Sling**

- Heavy Duty 1.5" Webbing and Elastic Construction
- Adjustable from 42" to 58" to Accommodate Various Body Types and Gear



Steel Push Button Quick Detach Sling Swivel for Quick Installation and Removal



Durable Bungee System Reduces Fatigue by Relieving the Felt Weight of the Firearm Away from the User's Shoulder



PVC-GB505B-B  
**Snap Hook Single Point Bungee Sling**

- Heavy Duty 1.5" Webbing and Elastic Construction
- Adjustable from 42" to 58" to Accommodate Various Body Types and Gear



Reinforced Spring Tensioned Metal Snap Hook for Quick Installation and Removal



Includes an Additional Single Point and Stock Adaptor Strap for Installation on a Wider Variety of Firearms



Durable Bungee System Reduces Fatigue by Relieving the Felt Weight of the Firearm Away from the User's Shoulder

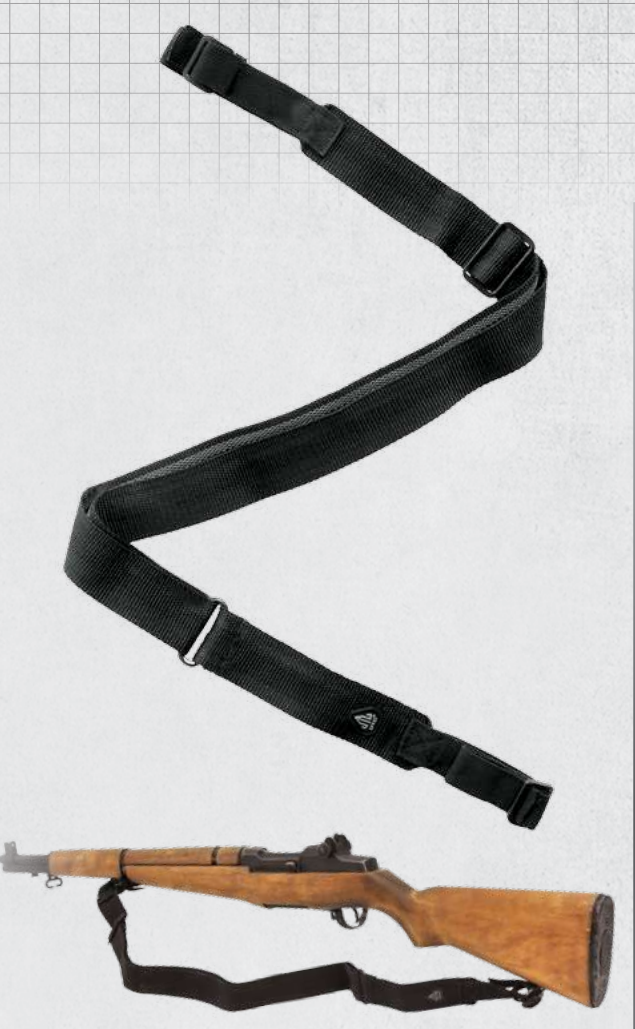

PVC-GB605  
**Deluxe Universal Rifle Sling**

- Adjustable Length from 44" to 52"



1.5" Wide Strap with Nonslip Grip Texture



Durable Sling Loops Keep Sling Securely Fastened



PVC-GB501  
**3 Point Tactical Rifle Sling**

- Fully Adjustable with Nonslip Grip Texture and Quality Snap Hooks
- Included Sling Adaptors Provide Versatile Use Across Various Firearms and is Easily Configurable in More Ways than One
- Adjustable Length from 30.5" to 78.7"



Stock Adaptor #1



Stock Adaptor #2



Nylon Cord Adaptor



Snap Hook

**Horizontal Shoulder Holsters**

- Universal Fit Compatible with Most Compact to Full Size Pistols
- Fully Adjustable Design Fits Most Body Types
- Reinforced Stitching and Seams
- Inverted Dual Magazine Pouch with Hook-and-loop Closures

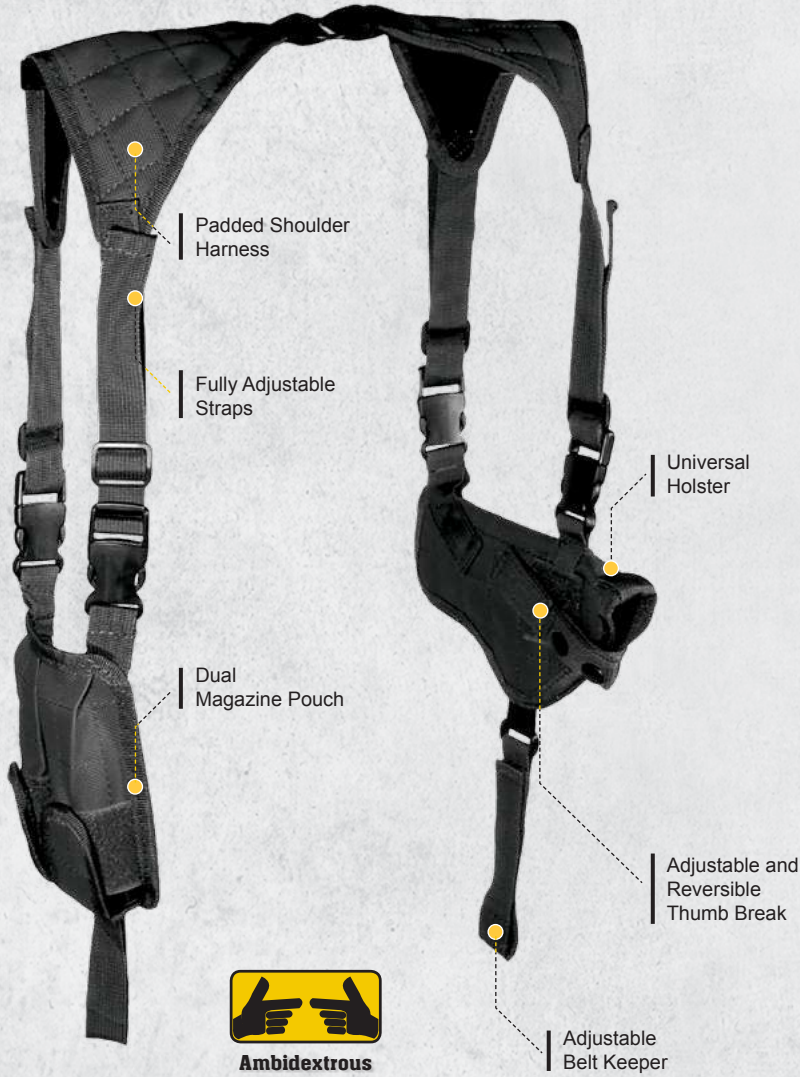

PVC-H170B  
**Horizontal Shoulder Holsters**

**Vertical Shoulder Holsters**

- Universal Fit Compatible with Most Compact to Full Size Pistols
- Fully Adjustable Design Fits Most Body Types
- Reinforced Stitching and Seams
- Inverted Dual Magazine Pouch with Hook-and-loop Closures

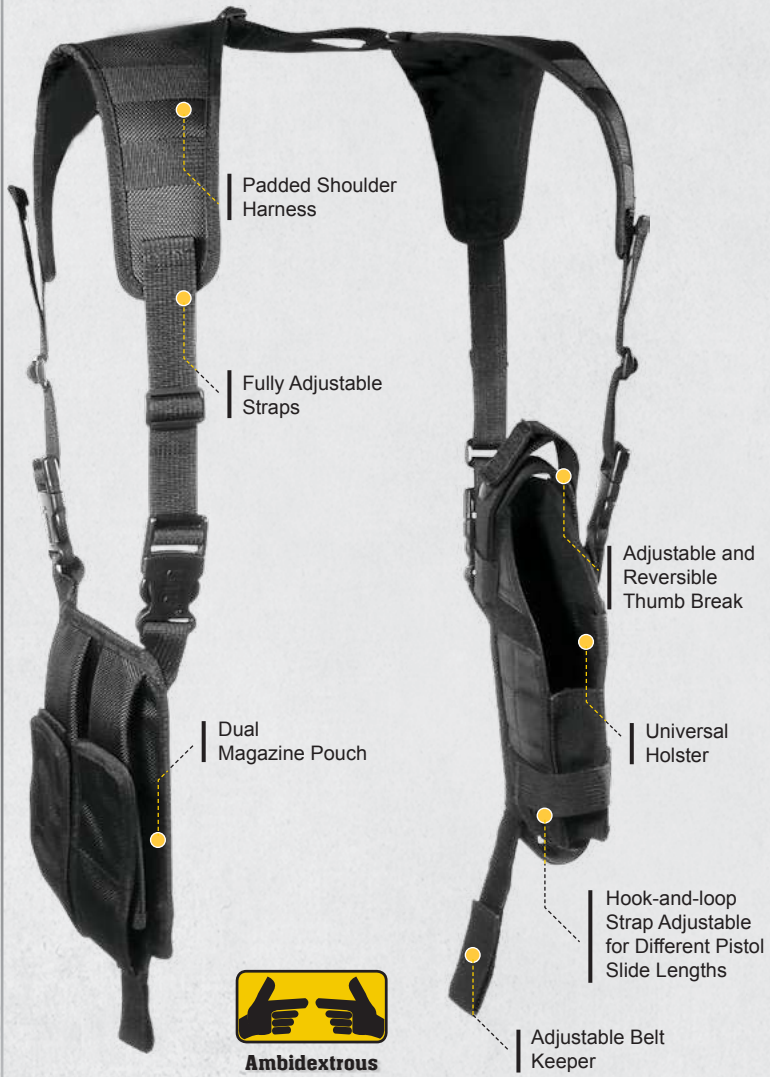

PVC-H175B  
**Vertical Shoulder Holsters**



**Concealed Belt Holster**

- Ideally Fits Most Sub-Compact Pistols
- Right Handed, Inside the Waistband (IWB) Carry
- Thickly Padded for Comfortable Carry
- Low Profile Elastic and Hook-and-loop Closure for Secure Retention



**Pocket Holsters**

- Ambidextrous with Closed Bottom
- Integral Nonslip Bands
- Side Pocket for Card-sized Storage



**Ankle Holster**

- Fits Most Sub-compact Pistols
- Form-fitting Elastic Holster for a Tight Universal Fit with Adjustable Hook-and-loop Retention Strap
- One Size Fits Most Users
- Hook-and-loop Calf Strap with Dual Vertical Support Straps for Carry Comfort



# TACTICAL BELT AND THIGH HOLSTERS

- RUGGED MATERIALS
- WEATHER PROOF COATINGS
- DURABLE HARDWARE
- PROTECTIVE PADDING
- COMFORTABLE CARRY
- AVAILABLE COLOR

BLACK



## Special Ops Tactical Thigh Holsters

- Fits Most Compact to Full Size Pistols
- Fully Adjustable Nonslip Leg Strap with Buckle Closure and Cushioned Wraparound Pad for Added Comfort and Retention
- Height Adjustable Belt Strap with Buckle Closure
- Adjustable Holster Strap Retention with Quick Release Buckle
- Built-in Spare Magazine Pouch



Hook-and-loop Strap Pulls Holster Towards Leg for a Close-to-body Fit



Right Handed

PVC-H178B

## Special Ops Tactical Thigh Holsters

Height Adjustable Belt Strap with Buckle Closure

Adjustable Retention Strap with Quick Release Buckle



Nonslip Textured Strap

Cushioned Wraparound Pad for Added Comfort and Retention

Adjustable Thigh Strap with Quick Release Buckle



Left Handed

PVC-H178BL

## Special Ops Tactical Thigh Holsters



Right Handed



Left Handed



PVC-H168ET  
PVC-H169ET

## Elite Tactical Thigh Holsters

- Fits Most Compact to Full Size Pistols
- Durable Composite Padding with Heavy Duty Quick Release Buckle System
- Height Adjustable Belt Strap
- Adjustable Holster Retention



Right Handed



PVC-H188B

## Extreme Ops Tactical Thigh Holster

- Adjustable Hook-and-loop Strap System Adapts Holster to Fit a Wide Variety of Light/Laser Bearing Compact to Full Size Pistols
- Height Adjustable Thumb Break
- Two Fully Adjustable Nonslip Leg Straps Minimizes Unwanted Movement
- Adjustable Hook-and-loop Strap at Muzzle Adapts to Different Slide and or Barrel Lengths



Ambidextrous

PVC-H288B

## Ambidextrous Belt Holster

- Universal Design with Open Bottom to Fit a Wider Variety of Compact to Full Size Pistols
- Adjustable Hook-and-loop and Snap-on Thumb Break Retention Strap



Right Handed

PVC-H270B

## Belt Holster

- Designed to Fit most Compact to Full Size Pistols
- Adjustable Holster Strap Retention with Quick Release Buckle
- Built-in Magazine Pouch
- Durable Hook-and-loop Belt Retention Strap





Front View



Rear View

**PVC-B998B**  
**Crime-buster Law Enforcement Complete Modular Equipment System**

- Modular Design with Versatile Features
- Premium Composite Material and Workmanship
- Easily Attach and Remove Components
- Great Field Gear for Law Enforcement and Security



**PVC-B950-A**  
**Law Enforcement & Security Duty Belt**



Detachable Belt Keepers Hook-and-Loop Adjustment (30" - 52" Waist) Two Horizontal Pistol Magazine Pouches Heavy Duty Quick Release Buckle



**NYL-ZA950**  
**Heavy Duty Web Belt**

- 2" Wide Belt with Hook-and-loop System Fits Up to a 48" Waist
- Adjustable with Quick Release Buckle



Durable Hook-and-loop Panel for Adjustment Up to 48" Waist



**PVC-MP2**  
**Dual Pistol Mag Pouch**

- Vertically Attaches Using ALICE Clips or Horizontally Via Hook-and-loop Straps
- Fits Most Double Stack Pistol Magazines

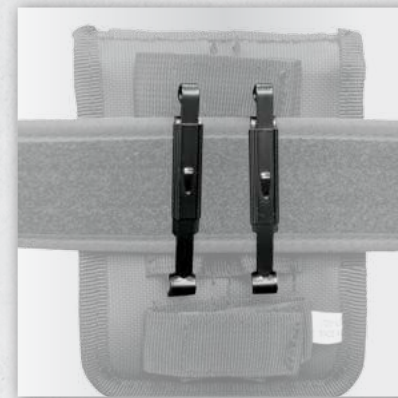

ALICE Clips Attach to Most Belts and MOLLE Webbing



**PVC-CLMAT01**  
**Universal Firearm Cleaning Mat**

- Durable Solvent and Chemical Resistant Padded Construction for Long Lasting Performance
- 14.75"x52", 3mm Thick



4" Wide Side Pocket with Zippered Closure

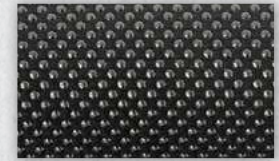

Nonslip Rubberized Backing



Rolls Up into Pouch for Easy Storage and Transportation

**PVC-SHL16**  
**AR15 Shell Catcher**



Designed for AR15 Rifles



Zippered Bottom for Easy Removal of Spent Casings





# INDEX

## A

AIR122S	051
AIR122SAB	051
AIR122SAR	051
AIR322S	051
AIR322SAB	051
AIR322SAR	051
AIR422S	051
AIR422SAB	051
AIR422SAR	051
AIR11834	051
AIR11834AB	051
AIR11834AR	051
AIR11834D	051
AIR11834G	051
AIR11834M	051
AIR11850	051
AIR11850AB	051
AIR11850AR	051
AIR11850D	051
AIR11850G	051
AIR11850M	051
AIR12234	051
AIR12234AB	051
AIR12234AR	051
AIR12234D	051
AIR12234G	051
AIR12234M	051
AIR12250	051
AIR12250AB	051
AIR12250AR	051
AIR12250D	051
AIR12250G	051
AIR12250M	051
AIR31834	051
AIR31834AB	051
AIR31834AR	051
AIR31834D	051
AIR31834G	051
AIR31834M	051
AIR31850	051
AIR31850AB	051
AIR31850AR	051
AIR31850D	051
AIR31850G	051
AIR31850M	051
AIR32234	051
AIR32234AB	051
AIR32234AR	051
AIR32234D	051
AIR32234G	051
AIR32234M	051
AIR32250	051
AIR32250AB	051
AIR32250AR	051
AIR32250D	051
AIR32250G	051
AIR32250M	051
AIR42250	051
AIR42250AB	051
AIR42250D	051
AIR42250G	051
AIR42250M	051

## L

MNT-RS10L	087
MNT-RS10S3	087
MNT-RSQD403	087
MNT-RSQD605	087
MT-750X	142
MT-754X	142
MT-945	140
MT-950RS03	142
MT-950X	143
MT-AFGK01	071
MT-AFGK01	075
MT-AFGK01	091
MT-AFGK01	148
MT-AFGK01	159
MT-AFGK01B	148
MT-AFGK01R	148
MT-AFGM01	067
MT-AFGM01	075
MT-AFGM01	148
MT-AFGM01	158
MT-AFGM01B	148
MT-AFGM01R	148
MT-AFGP01	077
MT-AFGP01	148
MT-EL223GX	118
MT-FGK01	071
MT-FGK01	075
MT-FGK01	081
MT-FGK01	091
MT-FGK01	150
MT-FGK01	159
MT-FGM01	067
MT-FGM01	075
MT-FGM01	150
MT-FGM01	158
MT-FGPO1	077
MT-FGPO1	150
MT-MRD13C	085
MT-MROAC	085
MT-MROXS	085
MT-RMR13C	085
MT-RMR45	085
MT-RMRAC	085
MT-RMRGL	085
MT-RMRKIT	085
MT-RMRXS	085
MT-RSX1L	086
MT-RSX1S	086
MT-RSX5L	086
MT-RSX5S	086
MT-RSX7L	086
MT-RSX7S	086
MT-RSX8L	086
MT-RSX8S	086
MT-RSX20MOA	086
MT-T1AC	085
MT-T113C	085
MTU001	076
MTU001R	076
MTU001SS	075
MTU001SSK	075
MTU001SSM	075
MTU001T	076
MTU002	095
MTU004SS	073
MTU004SSD	073
MTU004SSK	071
MTU005SS	073
MTU005SS3	087
MNT-RS08L	087
MNT-RS08S3	087

## M

MNT-16AD1-C	160
MNT-16AD2-C	160
MNT-22TOWL	096
MNT-722	143
MNT-745	140
MNT-755	141
MNT-757	141
MNT-910	143
MNT-914V2	096
MNT-950CS	142
MNT-955	141
MNT-957	141
MNT-993	089
MNT-ARMGB01	088
MNT-ARMGB01	145
MNT-BRO02S	098
MNT-BRO03XL	098
MNT-BRO03XLS	098
MNT-BRO05S	098
MNT-BRO05XL	098
MNT-BR101TR-A	089
MNT-DG02Q	109
MNT-DNT06	099
MNT-DT2PW01	059
MNT-DTW145	099
MNT-EL228GPG-A	119
MNT-G3601	097
MNT-GRP001Q	150
MNT-GRP001SQ	150
MNT-GRP002SQ	151
MNT-GRP003Q	150
MNT-HGR16S	089
MNT-HK02	097
MNT-M1C	096
MNT-MB500T	095
MNT-MNTR01	094
MNT-P501	097
MNT-P503	097
MNT-P505	097
MNT-P669	097
MNT-PMTOWL-A	099
MNT-R22SS26	096
MNT-RM700	096
MNT-RM700S	096
MNT-RM870A	095
MNT-RS05L	087
MNT-RS05S2	087
MNT-RS05S3	087
MNT-RS08L	087
MNT-RS08S3	087

## N

MNT-RS10L	087
MNT-RS10S3	087
MNT-RSQD403	087
MNT-RSQD605	087
MT-750X	142
MT-754X	142
MT-945	140
MT-950RS03	142
MT-950X	143
MT-AFGK01	071
MT-AFGK01	075
MT-AFGK01	091
MT-AFGK01	148
MT-AFGK01	159
MT-AFGK01B	148
MT-AFGK01R	148
MT-AFGM01	067
MT-AFGM01	075
MT-AFGM01	148
MT-AFGM01	158
MT-AFGM01B	148
MT-AFGM01R	148
MT-AFGP01	077
MT-AFGP01	148
MT-EL223GX	118
MT-FGK01	071
MT-FGK01	075
MT-FGK01	081
MT-FGK01	091
MT-FGK01	150
MT-FGK01	159
MT-FGM01	067
MT-FGM01	075
MT-FGM01	150
MT-FGM01	158
MT-FGPO1	077
MT-FGPO1	150
MT-MRD13C	085
MT-MROAC	085
MT-MROXS	085
MT-RMR13C	085
MT-RMR45	085
MT-RMRAC	085
MT-RMRGL	085
MT-RMRKIT	085
MT-RMRXS	085
MT-RSX1L	086
MT-RSX1S	086
MT-RSX5L	086
MT-RSX5S	086
MT-RSX7L	086
MT-RSX7S	086
MT-RSX8L	086
MT-RSX8S	086
MT-RSX20MOA	086
MT-T1AC	085
MT-T113C	085
MTU001	076
MTU001R	076
MTU001SS	075
MTU001SSK	075
MTU001SSM	075
MTU001T	076
MTU002	095
MTU004SS	073
MTU004SSD	073
MTU004SSK	071
MTU005SS	073
MTU005SS3	087
MNT-RS08L	087
MNT-RS08S3	087

## O

MNT-RS10L	087
MNT-RS10S3	087
MNT-RSQD403	087
MNT-RSQD605	087
MT-750X	142
MT-754X	142
MT-945	140
MT-950RS03	142
MT-950X	143
MT-AFGK01	071
MT-AFGK01	075
MT-AFGK01	091
MT-AFGK01	148
MT-AFGK01	159
MT-AFGK01B	148
MT-AFGK01R	148
MT-AFGM01	067
MT-AFGM01	075
MT-AFGM01	148
MT-AFGM01	158
MT-AFGM01B	148
MT-AFGM01R	148
MT-AFGP01	077
MT-AFGP01	148
MT-EL223GX	118
MT-FGK01	071
MT-FGK01	075
MT-FGK01	081
MT-FGK01	091
MT-FGK01	150
MT-FGK01	159
MT-FGM01	067
MT-FGM01	075
MT-FGM01	150
MT-FGM01	158
MT-FGPO1	077
MT-FGPO1	150
MT-MRD13C	085
MT-MROAC	085
MT-MROXS	085
MT-RMR13C	085
MT-RMR45	085
MT-RMRAC	085
MT-RMRGL	085
MT-RMRKIT	085
MT-RMRXS	085
MT-RSX1L	086
MT-RSX1S	086
MT-RSX5L	086
MT-RSX5S	086
MT-RSX7L	086
MT-RSX7S	086
MT-RSX8L	086
MT-RSX8S	086
MT-RSX20MOA	086
MT-T1AC	085
MT-T113C	085
MTU001	076
MTU001R	076
MTU001SS	075
MTU001SSK	075
MTU001SSM	075
MTU001T	076
MTU002	095
MTU004SS	073
MTU004SSD	073
MTU004SSK	071
MTU005SS	073
MTU005SS3	087
MNT-RS08L	087
MNT-RS08S3	087

## P

MNT-RS10L	087
MNT-RS10S3	087
MNT-RSQD403	087
MNT-RSQD605	087
MT-750X	142
MT-754X	142
MT-945	140
MT-950RS03	142
MT-950X	143
MT-AFGK01	071
MT-AFGK01	075
MT-AFGK01	091
MT-AFGK01	148
MT-AFGK01	159
MT-AFGK01B	148
MT-AFGK01R	148
MT-AFGM01	067
MT-AFGM01	075
MT-AFGM01	148
MT-AFGM01	158
MT-AFGM01B	148
MT-AFGM01R	148
MT-AFGP01	077
MT-AFGP01	148
MT-EL223GX	118
MT-FGK01	071
MT-FGK01	075
MT-FGK01	081
MT-FGK01	091
MT-FGK01	150
MT-FGK01	159
MT-FGM01	067
MT-FGM01	075
MT-FGM01	150
MT-FGM01	158
MT-FGPO1	077
MT-FGPO1	150
MT-MRD13C	085
MT-MROAC	085
MT-MROXS	085
MT-RMR13C	085
MT-RMR45	085
MT-RMRAC	085
MT-RMRGL	085
MT-RMRKIT	085
MT-RMRXS	085
MT-RSX1L	086
MT-RSX1S	086
MT-RSX5L	086
MT-RSX5S	086
MT-RSX7L	086
MT-RSX7S	086
MT-RSX8L	086
MT-RSX8S	086
MT-RSX20MOA	086
MT-T1AC	085
MT-T113C	085
MTU001	076
MTU001R	076
MTU001SS	075
MTU001SSK	075
MTU001SSM	075
MTU001T	076
MTU002	095
MTU004SS	073
MTU004SSD	073
MTU004SSK	071
MTU005SS	073
MTU005SS3	087
MNT-RS08L	087
MNT-RS08S3	087

## N

MTU005SSK	071
MTU006SS	064
MTU006SSD	065
MTU006SSK	071
MTU006SSM	069
MTU006SSMD	069
MTU007	077
MTU008SSK	073
MTU008SSM	069
MTU009	092
MTU009SSK	083
MTU010	073
MTU011	092
MTU012AG7	088
MTU012AG7	145
MTU014	093
MTU015	083
MTU015SS	075
MTU015SSK	083
MTU015SSM	075
MTU016	093
MTU017	073
MTU018	083
MTU019SS	073
MTU019SSD	073
MTU019SSK	071
MTU019SSKB2	072
MTU019SSKD	071
MTU019SSKM	071
MTU019SSKR2	159
MTU019SSKZ	071
MTU019SSKZ2	072
MTU019SSM	159
MTU019SSM3	067
MTU019SSM3T	067
MTU019SSMB2	072
MTU019SSMD	069
MTU019SSMR2	072
MTU019SSM2	158
MTU020SSA	082
MTU020SSB	082
MTU020SSC	082
MTU020SSKB	081
MTU020SSKC	081
MTU020SSMB	079
MTU020SSMC	079
MTU020SSME	079
MTU025SSK	021
MTU025SSM	069
MTU026SSKA	081
MTU026SSKB	021
MTU026SSKC	081
MTU026SSMA	079
MTU026SSMB	079
MTU026SSMC	079
MTU026SSME	079
MTU027SSKA	091
MTU027SSKC	091
MTU028SG	095
PVC-MC32B	095
PVC-MC30T22	096
PVC-MC42B	071
PVC-MC42B	130
PVC-MC42B	191
PVC-P124B	176
PVC-P248B	176
PVC-P365B	178
PVC-P365BC	178
PVC-P365BV	178
PVC-P372B	176

## P

NYL-ZA950	190
OP3-GM3124UMOA	020
OP3-GM4164UMOA	021
OP3-M3124AOIEW	021
OP3-M4164AOIEW	021
OP-DS2521R	189
OP-SW080	047
PUBCZ01	130
PUBCZ01B	130
PUBCZ01R	130
PUBCZ01Z	130
PUBGL01	130
PUBGL01B	130
PUBGL01R	130
PUBGL01Z	130
PUBGL02	130
PUBGL02B	130
PUBGL02R	130
PUBGL02Z	130
PUBHK01	178
PUBHK01B	178

## P

MTU005SSK	071
MTU006SS	064
MTU006SSD	065
MTU006SSK	071
MTU006SSM	069
MTU006SSMD	069
MTU007	077
MTU008SSK	073
MTU008SSM	069
MTU009	092
MTU009SSK	083
MTU010	073
MTU011	092
MTU012AG7	088
MTU012AG7	145
MTU014	093
MTU015	083
MTU015SS	075
MTU015SSK	083
MTU015SSM	075
MTU016	093
MTU	