

⚠ WARNING

❗ **Turn on the power in transmitter → receiver order. In addition, always check the operation of all the servos before use.**

⊘ **Do not insert or remove the servo connector while the receiver power is ON.**

- Since the S.BUS2 servo switches the operation mode automatically according to the type of signal (S.BUS signal/PWM signal) from the receiver, if the connector is inserted or removed while the power is ON, an S.BUS connected servo will be erroneously recognized and may stop.

⊘ **Do not leave the servo in the locked state.**

- Leaving the servo in the locked state (state in which enough force is applied that the servo cannot move) may cause smoke, fire, and damage.

⊘ **Never connect the battery in reverse.**

- Reverse connection may cause smoke, fire, and damage.

⊘ **Do not expose the servo to dust and water.**

- The servo does not have a waterproof construction. If it gets wet, the servo may not operate or the power supply may short circuit.

❗ **When installing the servo, check PUSHROD LINKAGE to make sure there is no binding in order to prevent excessive power consumption and decrease the life of the motor and battery.**

⚠ CAUTION

⊘ **Do not touch the servo case immediately after servo operation.**

- You may be burned because the motor and circuits inside the servo become hot.

⊘ **Do not turn the servo horn with unreasonable force.**

- The servo may be damaged.

⊘ **Do not disassemble or modify the servo.**

- The servo has a precision construction. Futaba Corp. will not be responsible for any disassembly or modification other than those specified by us.

⊘ **Do not drop the servo or expose it to strong shocks or vibrations.**

- It will damage with a shock.

❗ **Use the servo as an actuator in hobby applications.**

- Futaba will not be responsible if the servo is used in applications other than the above.

Futaba will not be responsible for damage, etc. caused by the use of parts other than Genuine Futaba parts.

•Power supply

Use the battery as specification. Use a battery or a voltage regulator with an ample margin as the power supply. The specified performance cannot be displayed with a dry cell battery.

Even if using a receiver with the BATTERY FAIL SAFE function, it may not operate correctly. Therefore, decide the safe number of uses by paying careful attention to the remaining battery capacity.

•System use

For full performance, 2.4GHz system is recommended.

Use this servo by car receiver. This servo cannot be used by air receiver.

•Programming function(P.G.)

This servo has **Futaba S.BUS2** system. This servo can be connected to a PC by using the CIU-2 USB Adapter sold separately and its various operating characteristics can be changed as a programmable servo by means of dedicated software "**S-Link**". **S-Link** is downloadable from a Futaba WEB site. Depending on a setup, a servo carries out vibration. If a servo continues carrying out vibration, it will break, please restore a setup.

[Servo Mounting Precautions]

- Use attached dampers and eyelets correctly.

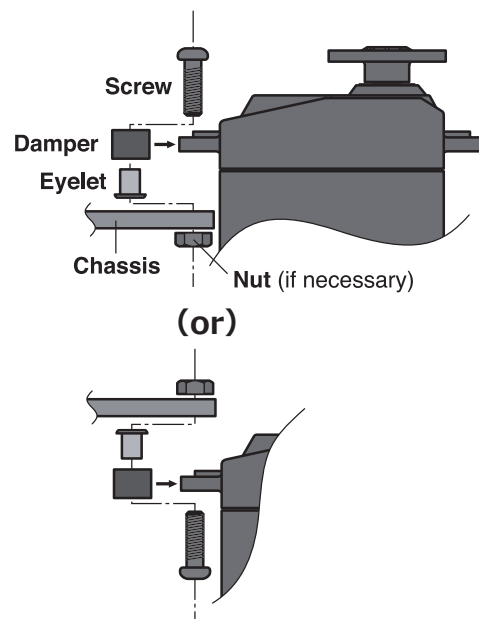

Futaba

High Voltage System *P.G.CAR SERVO* -----



S9570SV

S9570SV

P.G.CAR SERVO

		at 6.0V	at 7.4V
SPEED	(sec/60°)	0.10	0.08
TORQUE	(kgf · cm)	6.6	8.0
	(ozf · in)	91.67	111.1

SIZE 40.5×20.0×25.4 mm
(1.59×0.79×1.00 in)

WEIGHT 43.0g (1.52 oz)

RATED VOLTAGE DC6.0V~7.4V

OPERATING VOLTAGE DC4.0V~8.4V

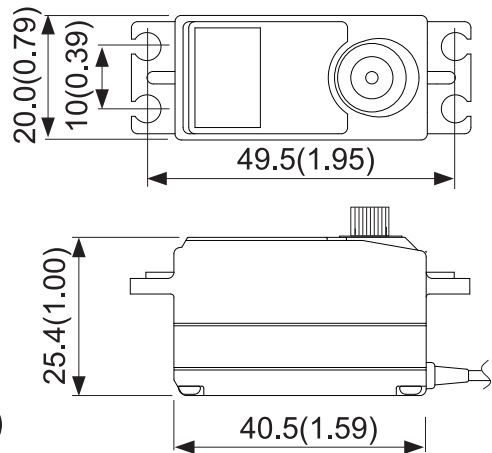

No dry battery use

Unit : mm(in)