

Features of GY440

- **Remote gain function and mode switching function**
You can adjust gain from the transmitter by using the remote gain function. Gain can also be adjusted with the trimmer on the GY440. The mode switching function allows AVCS/NORMAL gyro mode switching.
- **Integrated, compact, and light weight**
Compact size (20.5x20.5x11mm) and light weight (3.7g) realized by high density mounting technology.
- **Easy setup**
The GY440 can be used immediately with minimum setup.
- **Supporting the S.BUS/S.BUS2 connection**
Only one wire connection to the receiver can operate the GY440.

GY440 Ratings:

- (Integrated sensor type rate gyro)
- Gyro sensor: MEMS vibrating structure gyro
 - Operating voltage: DC4.0V to 8.4V
 - Current drain: 30mA (excluding a servo)
 - Operating temperature range: -10°C to +45°C
 - Dimensions: 20.5 x 20.5 x 11.0mm (except protrusion)
 - Weight: 3.7g
 - Functions: Sensitivity trimmer. LED monitor. Servo selection(1520uS, 760uS). S.BUS/S.BUS2 connection.

Functions

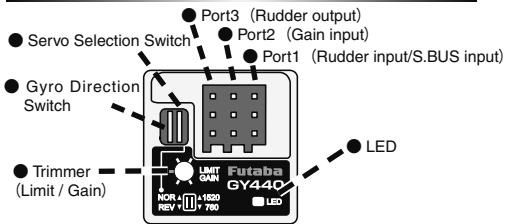

Monitor LED display

State	Color	Move	Reference
1. No servo pulse / sensor error	Red	Slow blink	
2. Warm-up	Green	Fast blink	
3. Sensor initialization	Red/Green	ON	AVCS (Red) Normal (Green)
4. Turn	Red/Green	Fast blink	Right (Green) Left (Red)
5. Neutral offset	Orange	Slow blink	Stick operation
6. Gain off	-	OFF	
7. Switch operation	Green	One blink	Each time of switch operation
8. Low battery	Red	One flash	Less than 3.8V

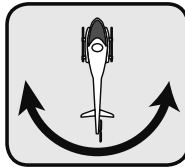

Thank you for purchasing a GY440 gyro, a rate gyro for RC helicopters. GY440 is a lightweight micro gyro developed for RC helicopter rudder (yaw axis) control. It can be used with minimum setup and includes an S.BUS/S.BUS2 port.

Before using your new gyro, please read this manual thoroughly and use the gyro properly and safely. After reading this manual, store it in a safe place.

- No part of this manual may be reproduced in any form without prior permission.
- The contents of this manual are subject to change without prior notice.
- Futaba is not liable for any potential damage (accidental or otherwise) that may occur after installation.

Set Contents

The following items are supplied with the GY440:

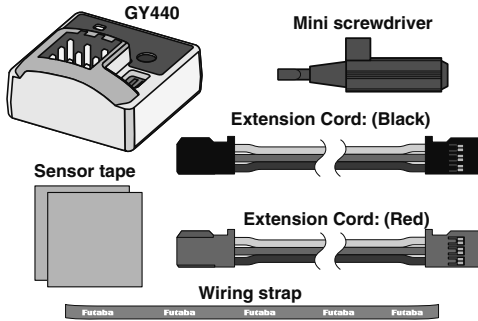

WARNING

Failure to follow these safety precautions may result in severe injury to yourself and others.

- Always check the transmitter and receiver battery voltage to ensure they have enough remaining capacity to complete the flight.
- The GY440 requires 3-5 seconds to initialize when the power is turned on. Do not move the helicopter and do not move the rudder stick during this initialization or the gyro may not initialize properly. Once the initialization process has been completed the rudder servo will move (a little) several times indicating that the GY440 is now ready for flight.
- Always ensure that there is some slack in the gyro cables to help maximize performance. Always use the supplied gyro mounting pads to attach the gyro to the helicopter mechanics. Do not use a strap that encompasses the GY440 sensor. This may affect the overall performance of the gyro.
- If you are switching between NORMAL mode and AVCS mode in flight, please keep in mind that you must have the gyro re-learn the center position after making a trim change within the transmitter. To memorize the new center position simply flip the gain switch on the transmitter three times between NORMAL mode and AVCS mode (NORMAL → AVCS → NORMAL → AVCS → NORMAL → AVCS) within one second. The servo will center indicating that the new center position has been memorized.
- Be sure to use a digital servo. Use only digital servos with the GY440. Using the GY440 with an analog servo will damage the servo.
- Always check the direction of operation of the servos. If you attempt to fly the model when a servo operates in the wrong direction, the fuselage will spin in a fixed direction and enter an extremely dangerous state.
- Do not drop the GY440 onto a hard surface or subject the GY440 to a strong shock as this may damage the sensor.
- When using the GY440 in the AVCS mode, set revolution mixing to OFF.
- Do not place gyro near heating equipment (engine, motor, ESC, battery, servo, etc.). Always allow the gyro to adjust to the surrounding environmental temperature before flight. A large temperature change during use will cause drift and other operational issues.

Connecting the GY440

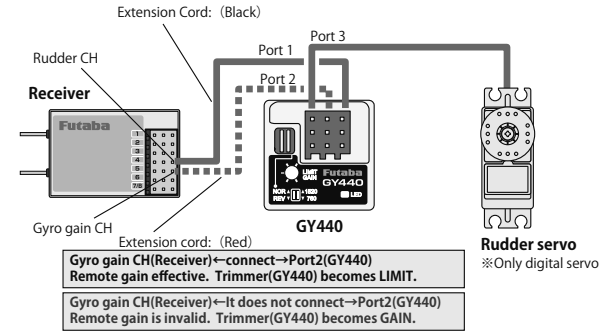

Connecting the GY440 (S.BUS)

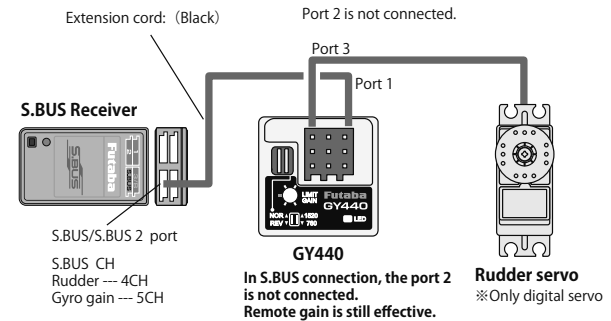

Mounting to Fuselage

GY440 installation precautions

- Always use the accessory sensor tape to install the GY440. Install the GY440 the center of the sensor tape.
- Depending on the vibration from the helicopter, the sponge may tear near the corners of the sensor tape. If the helicopter is flown in this state, vibrations will not be sufficiently absorbed and the sensor may fall off. Before flight, always check the sensor installation state. If the sponge is torn, replace it.
- Oil on the sensor bottom and the part installed to the frame can be wiped off with cleaner, etc.

Install the sensor so that the bottom of the gyro is perpendicular to the main rotor shaft axial direction. Offset of this axis will also react in the roll and pitch directions.

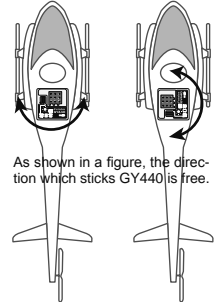
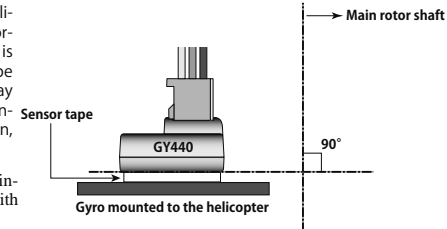

Rudder Servo Linkage Check

In the NORMAL mode, make the following linkage checks:

Make the initial linkage connections in the NORMAL mode. In this case, make adjustments mechanically and make minimum trimmer adjustments at the transmitter.

Move the rudder stick to the right and left and check the direction of operation of the tail rotor. If the tail rotor turns in the wrong direction, reverse the direction with the transmitter reverse function.

In the rudder neutral position, connect the linkage at the position at which the servo horn and control wire are perpendicular.

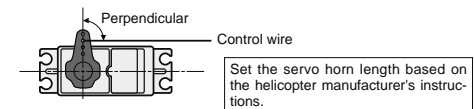

Adjustments

Please take a look at both the directions for the helicopter as well as the transmitter.

Setup before a flight [Remote gain use]

Adjusting gain with the transmitter.

When S.BUS connection or the gyro gain CH of the port 2 of a gyro and a receiver is connected.

- 1 Set the servo selection switch to the setting for your tail rotor servo. See chart below.

1520uS: BLS254, BLS257, S9254, S9257, etc.
760uS: BLS256HV, BLS251, S9256, S9251

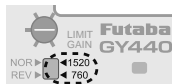

- 2 Set up your transmitter by following the directions in the manual. Gyro gain is set up to 50% by AVCS. Please refer to the graph, AVCS, NORMAL or when unclear. It judges by the LED on the GY440. AVCS: Red NORMAL: Green

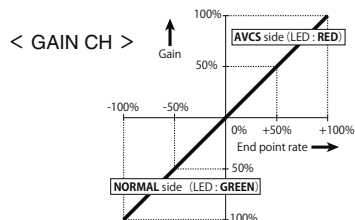

- 3 Receiver ON → The GY440 requires 3-5 seconds to initialize when the power is turned on. Do not move the helicopter and do not move the rudder stick during this initialization or the gyro may not initialize properly. Once the initialization process has been completed the rudder servo will move (a little) several times indicating that the GY440 is now ready for flight. If the neutral has shifted, LED will blink orange. In that case, it reboots.

- 4 Move the rudder stick to the left and right and make adjustments with the limit trimmer. Adjust for maximum travel, making sure the servo horn doesn't hit the linkage.

[Adjustment at the limit trimmer]

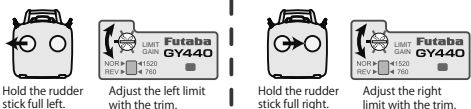

Bottom view of the tail section with the rudder stick full left.

Bottom view of the tail section with the rudder stick full right.

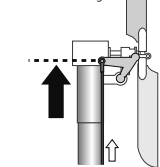
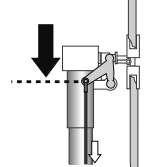

Adjust the linkage set up to get the maximum throw.

Adjust the linkage set up to get the maximum throw.

- 5 If the rudder servo moves to the Right when the nose of the helicopter moves to the Left, the gyro direction is correct. If the rudder servo moves to the Left, switch the direction using the Gyro Direction Switch.

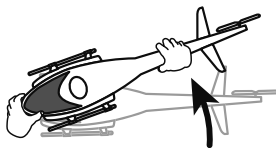

[Preflight check]

Helicopter is turned to the Left → Rudder operates on the Right.

*This check is performed in the state where an engine (motor) never starting.

If you try to fly the helicopter while the gyro direction is incorrect, when the rotor rotates clockwise, the helicopter nose will yaw to the Left and cause an extremely dangerous situation.

[Remote gain not use]

Adjusting gain with the GY440 trimmer.

When using an S.BUS connection and port 2 is not connected. In this case, a limit trimmer is automatically changed by the gyro gain setting trimmer. A limit is fixed by 50 degrees of right and left.

Similarly the procedure of 1.3.7 is followed.

< A gain trimmer's work >

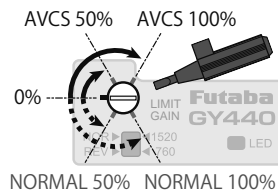

First, we suggest to start with AVCS set to 50%.

● A trimmer's operation

* Since the trimmer is small and delicate, operate it by gently using the provided mini screwdriver.

Operation in AVCS mode

If the rudder stick is operated or the helicopter is moved when the helicopter was stopped during operation in the AVCS mode, the servo will not return to the neutral position even if the rudder stick is returned to the neutral position, and when the rudder stick is moved, the rudder servo controls operation until the tail reaches the maximum point. This is caused by addition of an integration function as an AVCS mode operation and is not an abnormality. In actual flight, the gyro constantly monitors movement of the tail and controls the servo so that movement of the tail is stopped.

AVCS mode servo neutral position check method;

If the rudder stick or the helicopter was moved in the AVCS mode, the servo will not return to its original neutral position. When the power is turned on, the servo will return to the neutral position. The servo neutral position can also be checked by the following method.

Neutral position
Move the rudder stick 3 times to its full stroke to the left and check method right at an interval of within 1 second and immediately return the rudder stick to the neutral position. The servo moves to the neutral position about 1 second later.

Flight Adjustments

Adjust the transmitter and gyro while repeatedly taking off and landing and with the aircraft on the ground.

Transmitter adjustments must not be made while flying because it is dangerous.

- 1 Set the sensitivity to the position at which hunting does not occur during hovering and flight.
- 2 Adjust the hovering and flight rudder effect using the transmitter's D/R or AFR function.

* Do not adjust with the End Point (ATV) function. If the End Point (ATV) function is used, trimming may change.

AVCS / NORMAL Mode

NORMAL mode sends control signals to the rudder servo only when the tail of the helicopter moves. When the tail stops moving, the control signal from the gyro becomes zero. Conversely, the AVCS mode continues to send control signals to the servo even when the tail of the helicopter stops moving. The following sequentially describes the NORMAL mode and the AVCS mode.

Operation of NORMAL mode

Basic operation is described by considering the case when the helicopter is hovering under cross-wind conditions. With a normal mode, when the helicopter encounters a cross-wind, the force of the cross-wind causes the tail of the helicopter to drift. When the tail drifts, the gyro generates a control signal that stops the drift. When the tail stops drifting, the control signal from the gyro becomes zero. If the cross-wind continues to cause the tail to drift in this state, the "stop" operation is repeated until the tail faces into the winds. This is called the "weathervane" effect.

Operation of AVCS mode

Conversely, with an AVCS mode, when the helicopter encounters a cross-wind and the tail drifts, a control signal from the gyro stops the drift. At the same time, the gyro computes the drift angle and constantly outputs a control signal that resists the cross-wind. Therefore, drifting of the tail can be stopped even if the cross-wind continues to effect the helicopter. In other words, the gyro itself automatically corrects (auto trim) changes in helicopter tail trim by cross-wind. Considering operation of an AVCS mode, when the tail of the helicopter rotates, the servo also rotates in accordance with the angle of rotation of the tail. When the tail stops rotating, the servo judges that it has stopped in that position. This is the auto trim function.

In AVCS operation mode

AVCS is working properly during a cross wind.

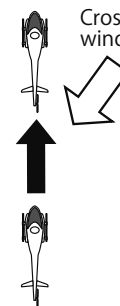

If no left rudder input is given, the machine will drift to the right.



If it starts right drift

In NORMAL operation mode

Hovering in a cross wind. The tail will drift.

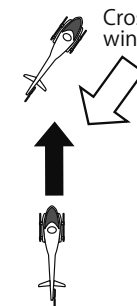

A head turns to a direction of movement automatically.



If it starts right drift

Hovering

High-speed flight

What is S.BUS?

Unlike conventional radio systems, the S.BUS system uses data communication to transmit control signals from a receiver to a servo, gyro, or other S.BUS compatible device. This data includes commands such as "move the channel 3 servo to 15 degrees, move the channel 5 servo to 30 degrees"

to multiple devices. The S.BUS devices execute only those commands for their own set channel. For this reason, it can be used by connecting multiple servos to the same signal line.

* Set the channel at the S.BUS servos by using an SBC-1 channel changer or a CIU-2 USB serial interface.

* Can also be used together with conventional servos. However, conventional servos cannot be used by the S.BUS output.

* When using servos with a remote battery pack, use S.BUS Hub with Cable (2-way/remote battery pack use).

* Please refer to the instruction manual of S.BUS Hub with Cable (2-way/remote battery pack use) for the connection method.

● Please turn on the power supply of the transmitter first without fail, and, next, turn on the receiver if you use S.BUS. Moreover, please use it after it confirms the operation without fail. Otherwise, the S.BUS communication cannot be judged and it is likely to malfunction.

● The wiring for the S.BUS servo is replaced at power supply OFF. If you replace the wiring in power supply ON, S.BUS communications cannot be judged, and it seems to malfunction.