

# 3PRKA

Frequency Hopping Spread Spectrum

**2.4GHz**  
**FHSS**



**3PRKA**  
3-channel, FHSS  
Radio control system  
for Car

## INSTRUCTION MANUAL

1M23N25002

**Futaba**® *Digital Proportional R/C System*

Safety Precautions .....	4
<b>Definition of Symbols</b> .....	4
<b>2.4GHz System Precautions</b> .....	4
<b>Operation Precautions</b> .....	5
<b>Storage and Disposal Safety Precautions</b> .....	6
<b>Other Safety Precautions</b> .....	7
Before Operation .....	8
<b>System Contents</b> .....	8
<b>Nomenclature / Handling</b> .....	9
Assembly / Adjustment .....	12
<b>Receiver and Servo Connection</b> .....	12
<b>Receiver Antenna Installation</b> .....	12
<b>Assembly Precautions</b> .....	13
<b>How to Link Transmitter and Receiver</b> .....	14
<b>How to Open Front Cover</b> .....	14
<b>Transmitter Set-Up Procedures</b> .....	15
3PRKA-2.4G Functions .....	16
<b>Steering Trim</b> .....	16
<b>Throttle Trim</b> .....	16
<b>Steering Dual Rates (D/R)</b> .....	17
<b>Steering Servo Reversing</b> .....	17
<b>Throttle Servo Reversing</b> .....	17
<b>Throttle End Point Adjustment (EPA-CH2)</b> .....	18
<b>CH3 Function</b> .....	18
<b>Fail Safe Function (F/S)</b> .....	18
<b>MC230CR/MC330CR</b> .....	19
Reference .....	20
<b>Ratings</b> .....	20
<b>Troubleshooting</b> .....	21
<b>Error Displays</b> .....	22
<b>When Requesting Repair</b> .....	22

Safety  
Precautions

Before  
Operation

Assembly /  
Adjustment

3PRKA-2.4G  
Functions

Reference

**Warning: This product contains a chemical known to cause cancer and birth defects (or other reproductive harm).**



- No part of this manual may be reproduced in any form without prior permission.
- The contents of this manual are subject to change without prior notice.
- This manual has been carefully written. Please write to Futaba if you feel that any corrections or clarifications should be made.
- Futaba is not responsible for the use of this product.

For your safety as well as that of others, please read this manual thoroughly prior to installation and operation of your digital proportional R/C system.

## Definition of Symbols

The following defines the symbols used in this manual.

### Explanation of Symbols

 <b>DANGER</b>	Procedures which may lead to a dangerous condition and cause death or serious injury to the user if not carried out properly.
 <b>WARNING</b>	Procedures which may lead to a dangerous condition or cause death or serious injury to the user if not carried out properly, or procedures where the probability of superficial injury or physical damage is high.
 <b>CAUTION</b>	Procedures where the possibility of serious injury to the user is small, but there is a danger of injury, or physical damage, if not carried out properly.

### Explanation of Graphic Symbols

 Indicates an operation that prompts a warning (including Caution).

 Indicates an operation that must not be performed.

 Indicates an operation that always must be performed.

## 2.4GHz System Precautions

### **WARNING**

 Do not cover/hold the built-in antenna part of T3PRKA-2.4G transmitter by your hand during running. Do not put any conductive plate/sticker on the antenna part. Otherwise, the operating range may become shorter.

 Do not perform the linking procedure while motor's main wire is connected or the engine is operating as it may result in serious injury.

 While the linking is done, please cycle receiver power and check if the receiver to be linked is really under the control by the transmitter to be linked.

 Always use R203GF 4.8V~7.4V rechargeable battery or regulated output from ESC. Using dry cell batteries may cause the system to malfunction. When using an ESC, be sure that the regulated output capacity meets your usage condition.

 In order to maintain complete control of your car/boat it is important that it remains visible at all times. Running behind large objects is not suggested. Doing so may result in the reduction of the quality of the radio frequency link to the model.

# Operation Precautions

## WARNING

---

 When using a Ni-Cd/Ni-MH battery to power your system, always charge and check the battery voltage prior to operation. Should the battery discharge below the minimum voltage level, control will be lost.

---

 Prior to operation always perform a range test. Even one abnormality in the R/C system may cause loss of control.

### **[Range Test Procedure]**

Have a friend hold the model, or place on a stand where the wheels or prop can not come in contact with any object. Operate from a distance of about 100 feet. Be sure to check the movement of each servo to make sure it follows the movement of the steering wheel and throttle trigger. If the servos do not follow the commands from the transmitter or any type of interference is detected, Do not operate the model.

---

 Never operate in the rain or run through puddles.  
The transmitter, receiver, batteries and most servos, and speed controls are not waterproof. Contact with any type of moisture or immersion in water or snow will cause damage along with possible loss of control. Should any type of moisture enter any component of the system, immediately stop using the R/C system and return it to our service center for inspection.

---

 Do not operate when visibility is limited.  
Should you lose sight of the model, a collision or other dangerous situation may occur.

---

 Do not operate near people or roads.  
Do not operate on any pond when boats are present.  
Do not operate near high tension power lines or communication broadcasting antennas.  
Prior to the operation of any model be sure the area you plan to use is safe. Be aware of all objects that may be in the path of your model. Do not operate the model where people or any type of moveable object could stray in the path of your model. Control loss due to interference, component failure, loss of sight or low battery voltage could result in serious injury to yourself and others as well as damage to your model.

---

 Do not operate when you are tired, not feeling well or under the influence of alcohol or drugs.  
Your judgment is impaired and could result in a dangerous situation that may cause serious injury to yourself and others.

---

 **(Turning on the power switches)**  
Always check the throttle trigger on the transmitter to be sure it is at the neutral position.

1. Turn on the transmitter power switch.
2. Turn on the receiver or speed control power switch.

### **(Turning off the power switches)**

Always be sure the engine is not running or the motor is stopped.

1. Turn off the receiver or speed control power switch.
2. Then turn off the transmitter power switch.

If the power switches are turned off in the opposite order the model may unexpectedly run out of control and cause a very dangerous situation.

---

 Make all adjustments to the radio control system with engine not running, or the electric motor disconnected.  
If the engine is running or the motor is connected while adjustments are made, the model may run out of control.

---

 Remove the main battery source from electric powered models when they are not being used.  
Should you accidentally leave the receiver switch on, the model could run out of control.

---

 **(Fail safe function)**  
Before running (cruising), check the fail safe function.

**Check Method:**

Before starting the engine, check the fail safe function as follows:

1. Turn on the transmitter and receiver power switches.
  2. Turn off the transmitter power switch.
  3. Check if the fail safe function moves the servos to the preset position when reception fails.
- The fail safe function is a safety feature that minimizes set damage by moving the servos to a preset position when reception fails. However, if set to a dangerous position, it has the opposite effect.

**Setting example:** Throttle idle or brake position

---

## CAUTION

---

 Do not touch the engine, motor, speed control or any part of the model that will generate heat while running.  
Touching hot parts will result in serious burns.

---

 When the charger is not in use, disconnect it from the outlet. This will prevent accidents, overheating and short circuits.

---

## Storage and Disposal Safety Precautions

---

## WARNING

---

 At the end of a day's operation, store the system with Ni-Cd/Ni-MH battery discharged. Be sure to recharge the system before it is used again.  
You should fully discharge your system's batteries periodically to prevent a condition called "memory". For example, if you only make two runs in a day or you regularly use a small amount of battery's capacity, the memory effect can reduce the actual capacity even if the battery is charged for the recommended amount of time.

---

 Do not throw a Ni-Cd/Ni-MH battery into a fire. Do not disassemble or attempt to repair a Ni-Cd/Ni-MH battery pack.  
Overheating, damage and acid leakage may lead to burns, loss of eye sight as well as numerous other types of injuries. The electrolyte in Ni-Cd/Ni-MH batteries is a strong alkali. Should you get even the smallest amount of the electrolyte in your eyes, Do Not rub. Wash immediately with water, and seek medical attention at once. The electrolyte can cause blindness. If electrolyte comes in contact with your skin or clothes, wash with water immediately.

---

- 
-  Do not leave the radio system or models within the reach of small children. A small child may accidentally operate the system. This could cause a dangerous situation and injuries. Ni-Cd/Ni-MH batteries can be very dangerous when mishandled and cause chemical damage.

## CAUTION

---

-  Do not store your R/C system where it will be exposed to the following conditions.
- Extreme heat or coldness
  - Exposed to direct sunlight
  - Where humidity is high
  - Where vibration is prevalent
  - Where dust is prevalent
  - Where there is steam and condensation

Storing your R/C system under adverse conditions could cause deformation and numerous other problems with operation.

- 
-  If the system will not be used for a long period of time, remove the batteries from the model and store in a cool, dry place. If the batteries are left in the model, electrolyte may leak and damage the model.

### <Ni-Cd/Ni-MH Battery Recycling>

A used Ni-Cd/Ni-MH battery is a valuable resource. Insulate the battery terminals and dispose of the battery by taking it to a battery recycling center.

## Other Safety Precautions

## CAUTION

---

-  When operating two or more models at the same time, have a third person act as a spotter. They will be in charge of safety and you should follow their instructions.

-  Beginners should receive instructions regarding safety and operation from an experienced modeler.

-  Always use only genuine Futaba transmitter, receivers, servos, and electronic speed controls, along with other optional parts and components. Futaba will not be held responsible for damages caused by other than genuine Futaba parts and components. Use only genuine Futaba parts and components listed in the instruction manual and catalog.

- 
-  Do not short circuit the Ni-Cd/Ni-MH battery terminals. Short circuiting the terminals will lead to sparks and overheating and could cause a fire and burns as well.

- 
-  Do not expose plastic parts to fuel, motor spray, waste oil or exhaust. The fuel, motor spray, waste oil and exhaust will penetrate and damage the plastic.

### <Ni-Cd/Ni-MH Battery Electrolyte>

The electrolyte in Ni-Cd/Ni-MH batteries is a strong alkali. Should you get even the smallest amount of the electrolyte in your eyes, DO NOT RUB. Wash immediately with water and seek medical attention at once. The electrolyte can cause blindness. If electrolyte comes in contact with your skin or clothes, wash with water immediately.

## System Contents

After opening the container, check the contents for the following items. The contents will vary with the system purchased.

3PRKA-2.4GHz System Contents				
Transmitter	T3PRKA-2.4G (x1)			
Receiver	R203GF (x1)			
Servo	-----	S3003 (x2)	S3003 (x1)	S3050 (x1)
E.S.C.	-----	-----	MC230CR or MC330CR (x1)	MC330CR (x1)
Switch	SSW-GS (x1)		-----	-----
Miscellaneous	Mini Screwdriver *Servo mounting hardware and servo horns (only w/servo set)			

**NOTE:** Futaba FHSS system, T3PRKA-2.4G transmitter and R203GF receiver, does not work with current Futaba FASST systems. Please use T3PRKA-2.4G and R203GF in pairs. Futaba FASST system and FHSS system are not compatible each other.

### Receiver R203GF

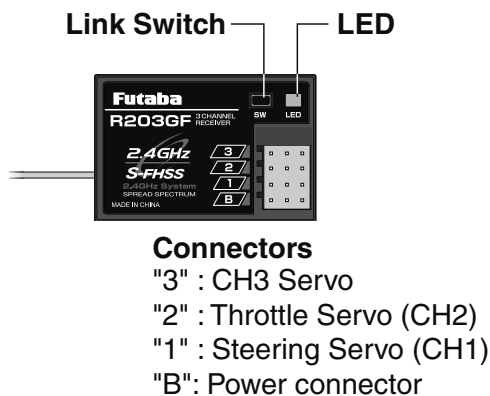

### Servo S3003/S3050

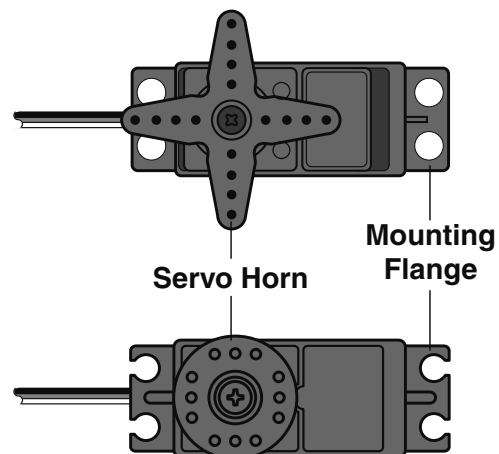

# Nomenclature / Handling

## Transmitter T3PRKA-2.4G ⚠WARNING

! As with all radio frequency transmissions, the strongest area of signal transmission is from the sides of the antenna(built-in). As such, the antenna(arrow direction) should not be pointed directly at the model.

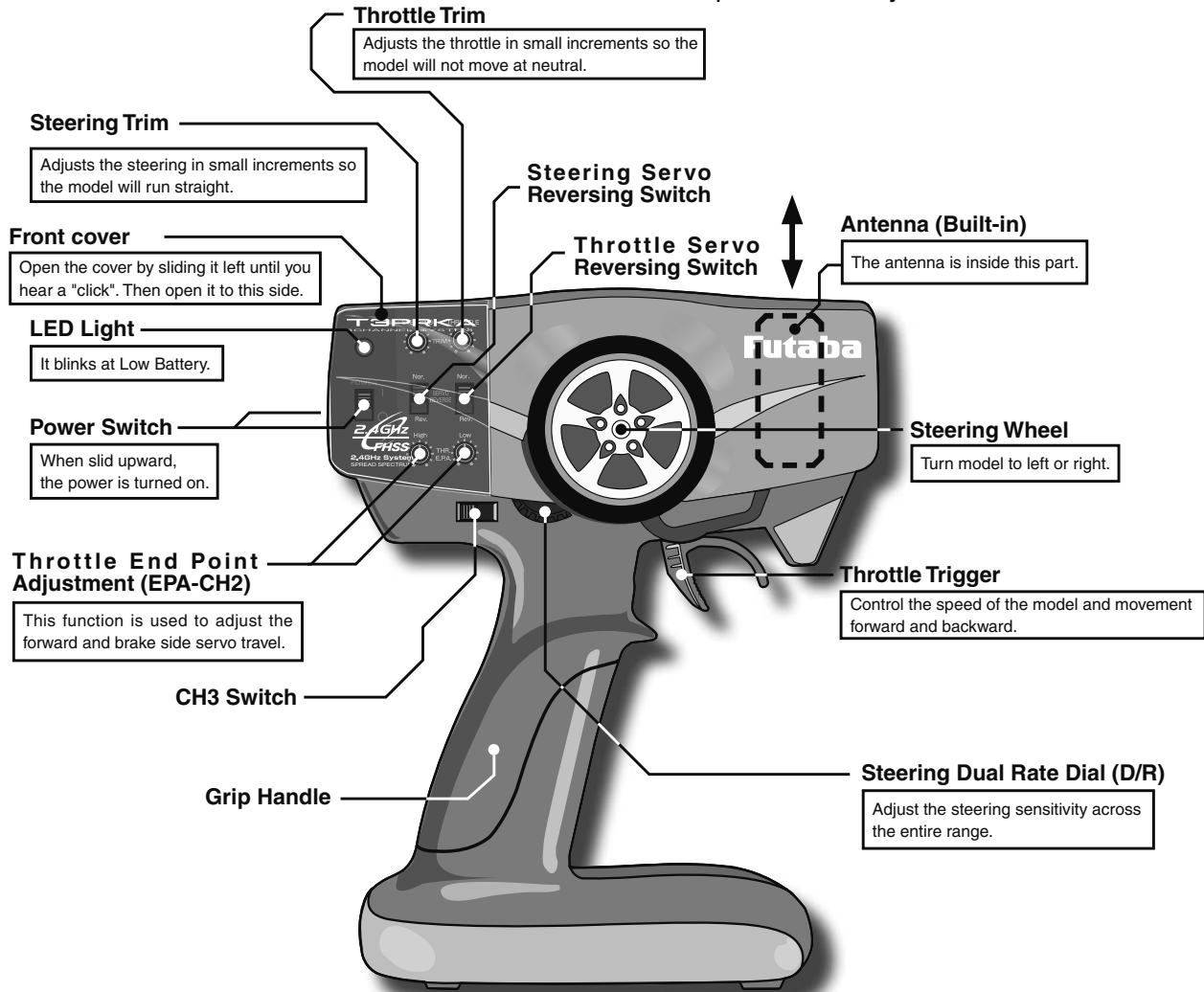

## ⚠WARNING

⊘ Do not cover/hold the built-in antenna part of T3PRKA-2.4G transmitter by your hand during running.  
Do not put any conductive plate/sticker on the antenna part.  
Otherwise, the operating range may become shorter.



## Battery Replacement Method

(4 AA size batteries)

- 1** Remove the battery cover from the transmitter by sliding it in the direction of the arrow in the figure.
- 2** Remove the used batteries.
- 3** Load the new AA size batteries. Pay very close attention to the polarity markings and reinsert accordingly.
- 4** Slide the battery cover back onto the case.

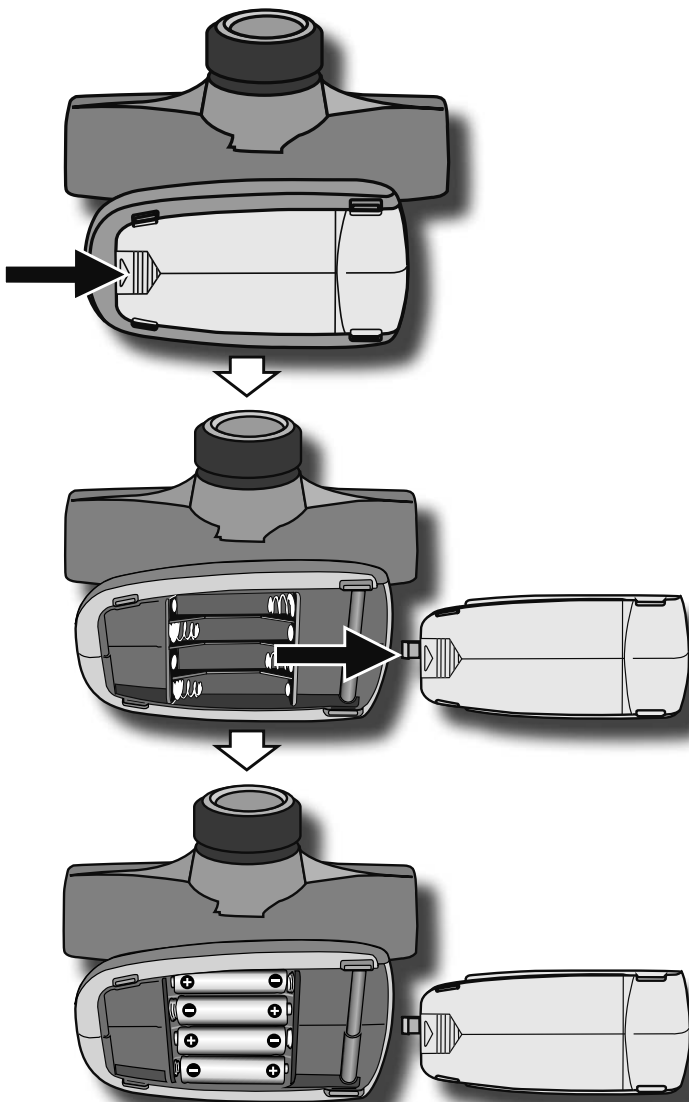

## ⚠ CAUTION

- ⚠ Always be sure you reinsert the batteries in the correct polarity order. If the batteries are loaded incorrectly, the transmitter may be damaged.
- ⚠ When the transmitter will not be used for any short or long period of time, always remove the batteries. If the batteries do happen to leak, clean the battery case and contacts thoroughly. Make sure the contacts are free of corrosion.

Check:

Turn the power switch on the transmitter to the ON position. Check the battery voltage display on the LED light.

If the voltage is low, check the batteries for insufficient contact in the case or incorrect battery polarity.

Low Battery :

When the LED starts blinking, change the batteries immediately.

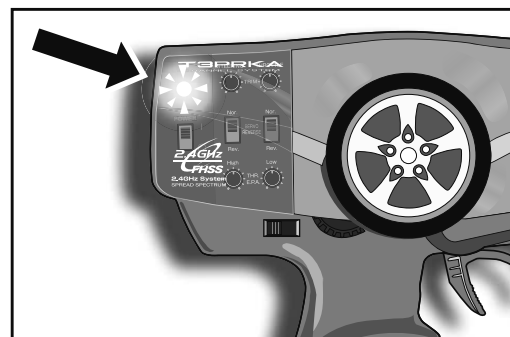

The low battery alarm is meant to be a safety feature only. Do NOT operate your radio below low battery. Always shut your radio off as soon as possible after the low battery warning loss of control.

# E.S.C. MC230CR / MC330CR

## Applicable motors (Number of turns is criteria.)

- Use the MC230CR with a motor with 20T or more turns.
- Use the MC330CR with a motor with 13T or more turns.

\*If a motor with a number of turns smaller than the above is used, the heat protector and overcurrent protection circuit may operate. The number of turns of the motor is only one criteria. Depending on the running conditions, the protection circuit may operate even if the condition above is satisfied.

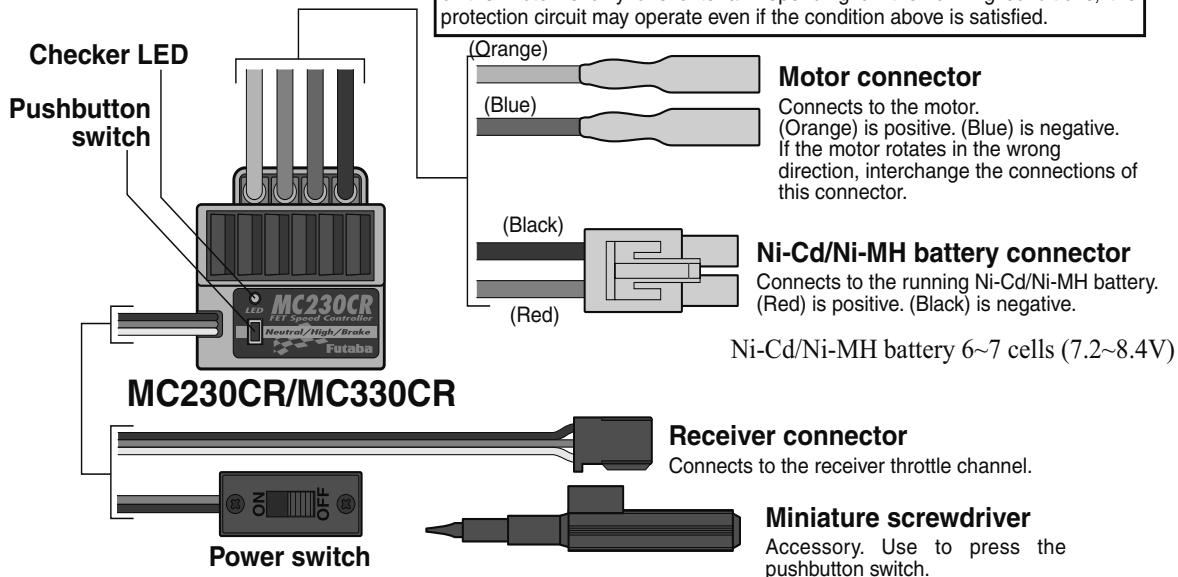

## Receiver and Servo Connection

As you connect the receiver, servos and other components, do so in accordance with the "Assembly Precautions".

**Connections when a E.S.C. MC230CR or MC330CR are used.**

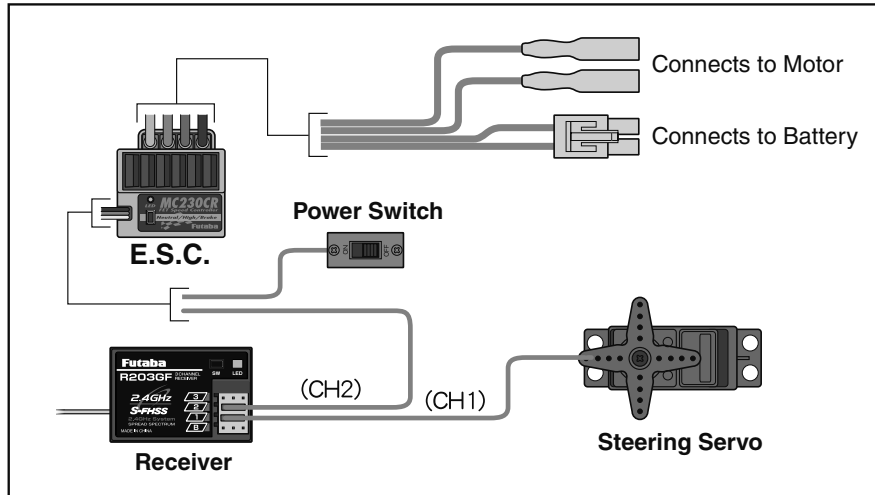

**Gas Powered Model**

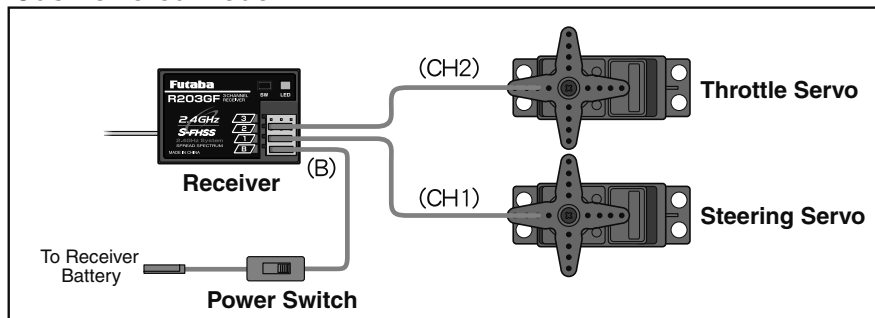

## Receiver Antenna Installation

Install the R203GF receiver on the car as follows:

**Note:** The operating range may become shorter, depending on where the receiver and the antenna are mounted.

### ⚠ WARNING

❗ Install the antenna in the higher place as shown in the figure. Keep the antenna as far away from the motor, ESC and other noise sources as possible. Put the antenna in the antenna tube to protect it.

⊘ Do not cut the antenna. Do not bend the coaxial cable. Doing so causes damage.

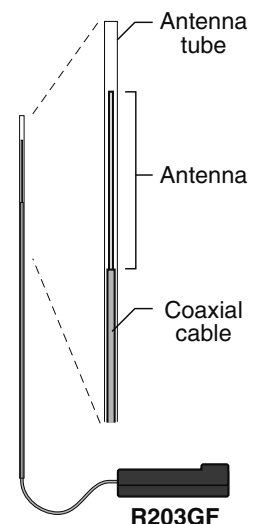

## Assembly Precautions

### ⚠ WARNING

- 
- ❗ Check the receiver, servos, and battery connectors, to be sure they are firmly connected. If a connector is not fully inserted, vibration may cause the connector to work loose while the model is operating. This will result in loss of control.
- 
- ❗ Operate each servo horn over its full stroke and check to see that the linkage does not bind or is not too loose. Excessive force applied to the servo horn by binding or poor installation may lead to servo problems and result in loss of control.
- 
- ❗ **(Electric Cars and Boats)**  
Isolate the receiver from vibration by attaching to the chassis or mounting plate with thick double sided tape.
  - ❗ **(Gas Powered Cars and Boats)**  
Isolate the receiver from vibration by wrapping it in foam rubber or similar type cushioning material. Protect the unit from water damage by placing it in a plastic bag or waterproof radio box.  
The receiver contains precision electronic parts. These parts are vulnerable to vibration and shock. Any contact with moisture (water or condensation) may cause receiver malfunction and loss of control.
- 
- ❗ Use the servo horn screw.  
When the servo horn comes off, it becomes loss of control.
- 
- ❗ Keep all devices that emit high frequency noise, such as motors, batteries, and wiring that handles heavy current loads, at least 1/2 inch away from the receiver and the receiver antenna.  
High frequency noise will cause a decrease in operating range and could cause loss of control.
- 
- ❗ Install electronic speed control heat sinks as well as other components that conduct electricity so they can not come in contact with aluminum, carbon fiber or other materials that conduct electricity.  
If, for example, the speed control came loose while the model was running and touched an aluminum chassis, a short circuit may occur that would cause irreparable damage to the system as well as loss of control.
- 
- ❗ Noise suppression capacitors should be installed on almost all motors.  
If the proper capacitors are not installed, high frequency noise will reduce range and cause loss of control along with various other problems.
- 
- ❗ Inspect all linkage installations and any point where metal could come in contact with other metal parts. Make sure these parts do not touch other metal parts under vibration.  
Should a linkage or other metal parts come in contact with other metal parts under vibration, the high frequency noise generated by this contact will cause interference and possible loss of control.

### ⚠ CAUTION

- 
- ⊘ Do Not disassemble any part of this system that is not specified in the instruction manual. Futaba will not be responsible for any damage due to improper disassembly of any part of the radio control system.

## How to link the transmitter and the receiver

Each transmitter has an individually assigned, unique ID code. In order to start operation, the receiver must be linked with the ID code of the transmitter with which it is being paired. Once the link is made, the ID code is stored in the receiver and no further linking is necessary unless the receiver needs to be used with an other transmitter. (For T/R set, the link is already done at factory.)

Link procedure

- 1** Bring the transmitter and the receiver close to each other, within 0.5 meter.
- 2** Turn on the transmitter and the receiver.
- 3** Push and hold the Link Switch of the receiver.
- 4** When the link is complete, the LED in the receiver changes to solid green.

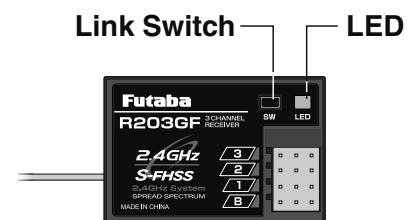

\*Please refer the table below for LED status vs receiver's condition.

LED status vs receiver's condition:

No signal reception	<b>OFF</b>
Receiving signals	<b>On</b>
Receiving signals, but ID is unmatched.	<b>Blink</b>
Receiving signals, when F/S is set.	<b>It is turns on and a fast blink for the first one second.</b>

## How to open front cover

The switch and the trimmer which adjusts it are in the front cover.

Open the cover by sliding it to the left until you hear a "click". Then open it to side.

 Do not force the cover to open 90° or more.



# Transmitter Set-Up Procedures

\*When making these settings adjustments, do so with the motor disconnected or the engine not running.

## Servo Horn Installation Instructions

**1** Connect the receiver, servos, and other components and then turn on the power switches to transmitter and receiver.

\*Both servos will move to the neutral position.

**2** At this time install the servo horn in the manner described in the instruction manual provided with the model this system will be used in.

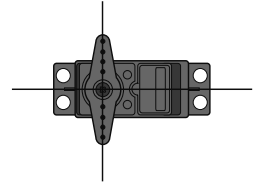

## Reversing The Servo Operation Direction

Should the servo operate in the opposite direction required for your application, reverse the direction with the servo reversing.

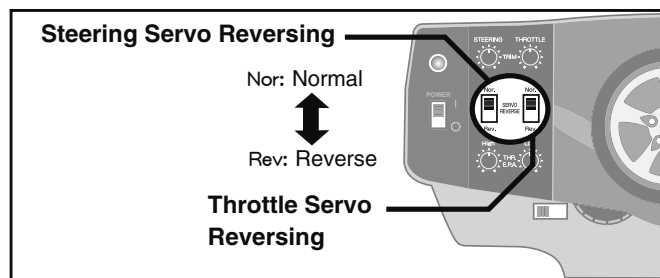

## E.S.C. MC230CR / MC330CR NEUTRAL, HIGH, AND BRAKE MAX POINT SETTINGS

### ⚠ CAUTION

Set the steering angle adjustment function (E.P.A) to 100% using the transmitter throttle channel function.

\*When using the another transmitter with ABS function, after setting up the MC230CR / MC330CR, stop the reverse function, then turn on the ABS function. If the ABS function is on, the MC231CR / MC331CR cannot be set up correctly.

Before setting each point, set the transmitter throttle channel trim to neutral.

**1** Turn on the power in transmitter -> amp order.

	Transmitter throttle operation	MC230CR / MC330CR (Pushbutton switch operation)	MC230CR / MC330CR (Checker LED)
<b>2</b> Neutral point setting	Neutral state	Press the pushbutton switch. (0.5 secs or longer) (Confirmation beep sounds)	LED • Continuous single blink 
<b>3</b> High point setting	Full High N	Press the pushbutton switch. (Confirmation beep sounds)	LED • Continuous double blink 
<b>4</b> Brake MAX point setting	Full brake N	Press the pushbutton switch. (Confirmation beep sounds.)	LED • If the LED goes out, setting is complete. 

If the LED does not go off but blinks rapidly, setting was not performed normally. Repeat setting from "Neutral point setting".

• Continuous rapid blink

\* Since the data is read at the end of setting of all points, the points cannot be set independently.

\* If the amp power was turned off during setting, the setting points cannot be memorized. (The previous settings are retained.)

\* The confirmation beep sounds only when the motor was connected.

## Steering Trim

Steering neutral adjustments can be made by moving the Steering trim knob to the left or right.

### Racers Tip

When you install a servo, always check to be sure the servo is at its neutral position. Adjust the servo horn hole position and linkage so both are parallel. When a servo saver is used, place it as close to center position as possible. Be sure the steering trim on the transmitter is at the neutral position.

**Trim Operation And Maximum Travel**  
Changing the trim can affect the overall settings. When adjustments are made with the trims, recheck your installation for maximum travel. (Steering D/R).

### When Trim usage is extreme

If it takes most of your trim movement to get a servo to the neutral position, reposition the servo horn or servo saver on the servo and inspect your linkage installation.

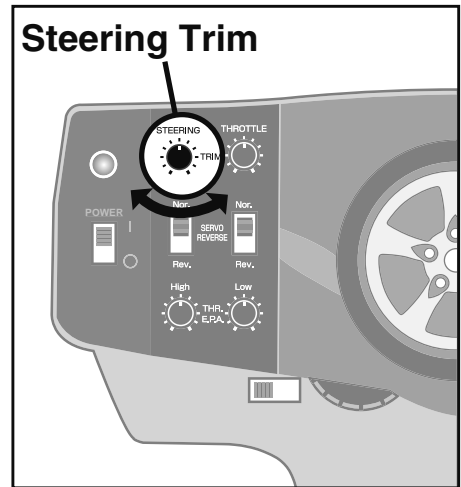

Direct Servo Saver Horn

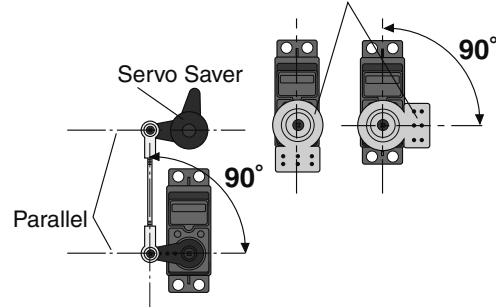

## Throttle Trim

Throttle neutral adjustments can be made moving the throttle trim to the left or right.

### Racers Tip

When using an electronic speed control, set the throttle trim to neutral and make adjustments to the speed control. On a gas powered model, set the trim to neutral and adjust the linkage to the point where the carburetor is fully closed in accordance with the engine instruction manual.

### Trim Operation and Travel

Trim adjustments will affect the overall servo travel. Check the brake side (backward) movement when changes are made.

### When trim movement is extreme

If you use most of the trim movement to get the servo to the neutral position, recenter the servo horn closer to the neutral position and inspect your throttle linkage.

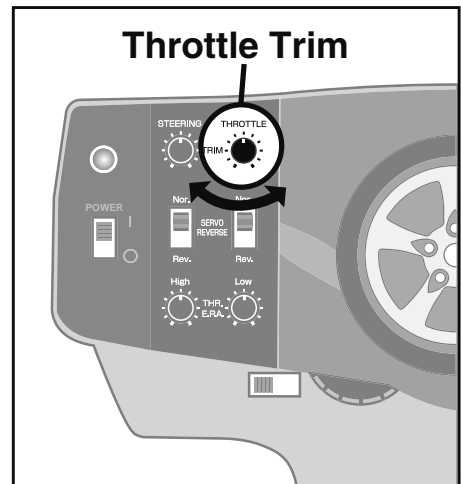

Carburetor Fully Closed

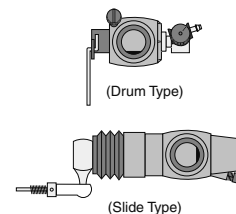

## Steering Dual Rates

Use this function to adjust the steering travel of your model. If the model understeers while cornering, add steering by turning CW of the D/R button. When the model oversteers, take away steering by turning CCW of the D/R button.

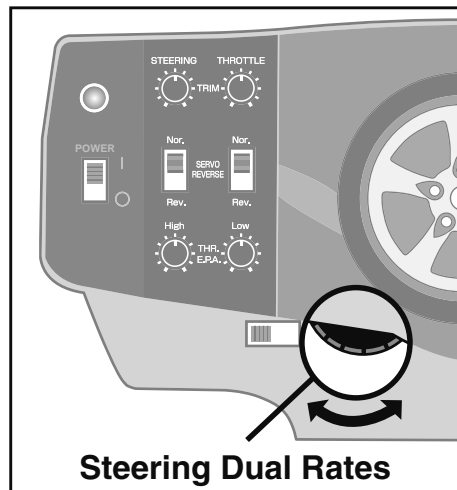
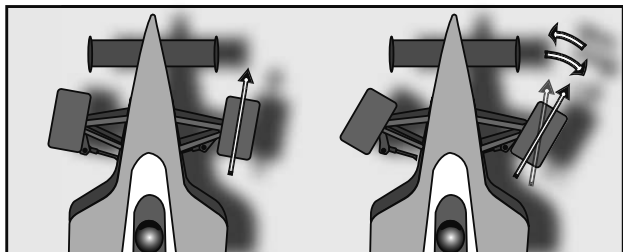

### ⚠ WARNING

! Be sure that the steering linkage does not bind or come in contact with any suspension parts or arms. If unreasonable force is applied to the servo, the servo may be damaged and result in loss of control.

## Steering Servo Reversing

This function reverses the rotation direction of the Steering servo.

When the trim position deviates from the center, the deviation will be on the opposite side when the servo is reversed.

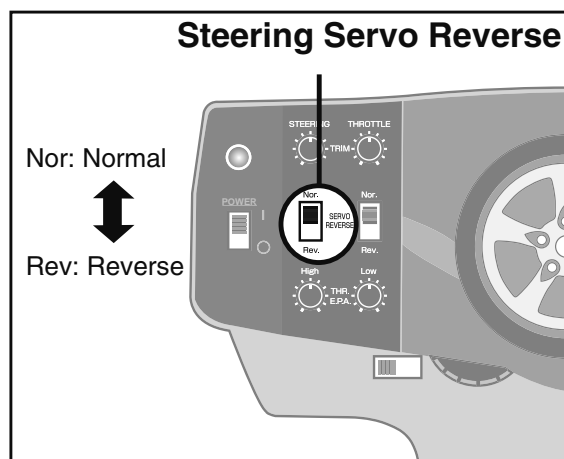

## Throttle Servo Reversing

This function reverses the rotation direction of the throttle servo.

When the trim position deviates from the center, the deviation will be on the opposite side when the servo is reversed.

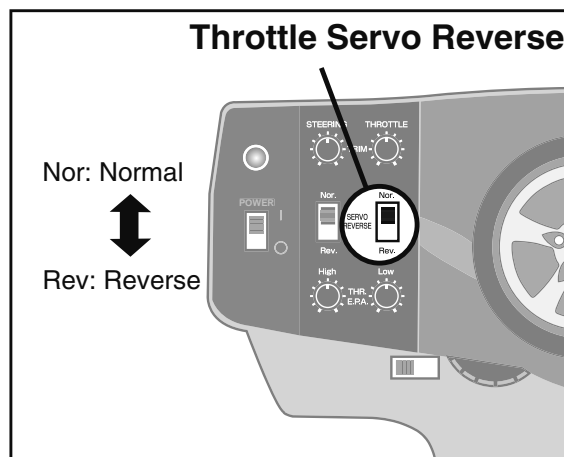



## Throttle End Point Adjustment(EPA)

This function is used to adjust the forward and brake side servo travel. Each direction can be adjusted independent of each other. Use this feature to set the throttle servo travel.

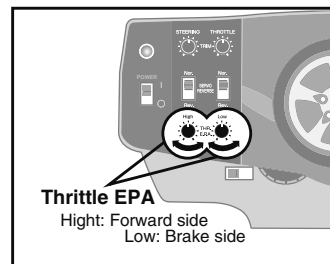

When ESC is used with an electric car, two EPA trimmers are right fully turned beforehand.

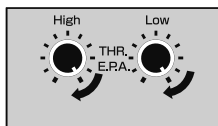

### ⚠ WARNING

- Be sure that your throttle linkage does not apply excessive force to the servo. If your linkage installation causes an unreasonable amount of force to be applied to the servo, the servo may be damaged and result in loss of control.

## CH3 Function

One other Channel can be used besides the steering wheel and the throttle operation. Right and left operation of two actions can be done by using the servo. ON-OFF the headlight etc. can be operated by using "CPS-1" (sold separately).

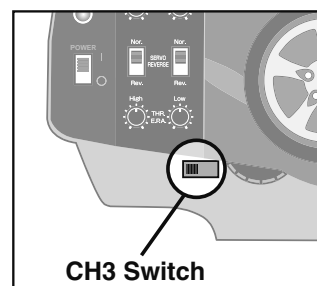

CH3 cannot operate EPA function and servo linearly.

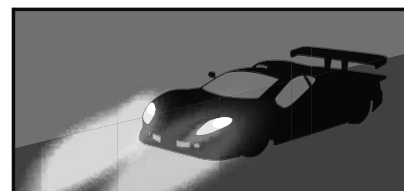

< One example using CPS-1 >

## Fail Safe Function (F/S)

This function moves the throttle servo to a preset position when the receiver cannot receive the signal from the transmitter for some reason.

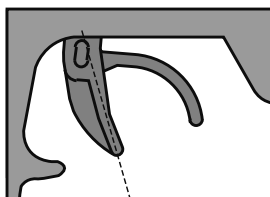

For an electric car (E.C.S use), link the transmitter and the receiver at neutral position.

When the signal from the transmitter can be received again, this function automatically resets. The throttle position at the link operation is memorized.(P.14)

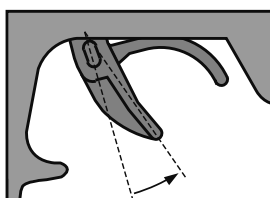

For the engine car, link the transmitter and the receiver at braking position.

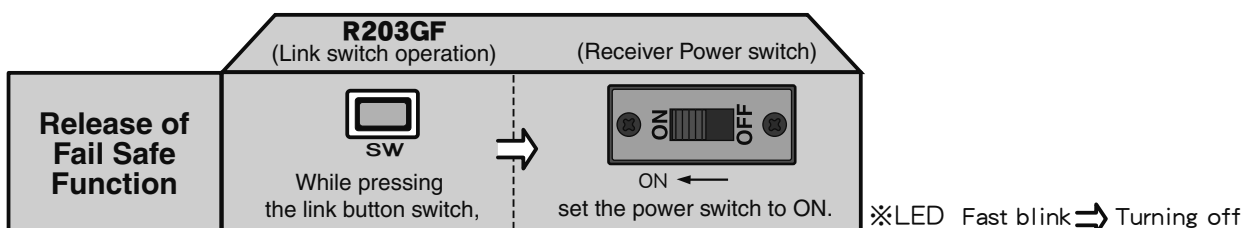

# MC230CR/MC330CR

## CANCELLING THE REVERSE FUNCTION

The amp reverse function can be cancelled by the following method so that the model can be used even in races that prohibit reverse running. (Brake operation only)

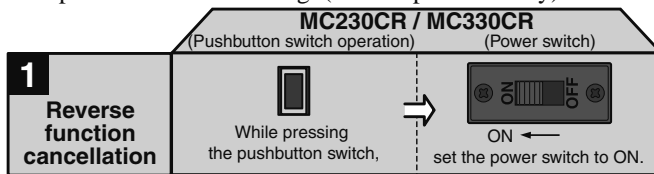

\* When desired, you can enable the cancelled reverse function by repeating the operation shown at the left. (The reverse function is switched alternately.)

## BRAKE/REVERSE OPERATING INSTRUCTIONS

Operation can be switched to reverse operation by returning the throttle trigger (or throttle stick) from the brake position to the neutral position.







## PROTECTION CIRCUIT OPERATION

The following protection circuits are built into the MC230CR / MC330CR. When a protection circuit operates, remove the cause before operating the model again.

<b>Overcurrent protection</b>	When an overcurrent flows due to an output short circuit, etc., the overcurrent protection circuit automatically limits the current to protect the FET. ⇒ Remove the cause of the short circuit, etc. before operating the model again.
<b>Heat protector</b>	When abnormal heating of the FET due to an overload, etc. is detected, the heat protector operates so that the speed is gradually reduced. ⇒ When the FET temperature drops, the heat protector automatically resets. However, remove the cause of the overheating before operating the model again.
<b>Low voltage operation</b>	When the Ni-Cd/Ni-MH battery voltage drops, this function limits the motor output current and ensures steering operation. ⇒ After the speed drops, immediately recover the vehicle.

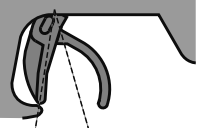
## CHECKER LED DISPLAY

The amp operates linearly in proportion to the amount of forward, reverse, and brake operation. The amp operating state can be checked with the checker LED as shown below.

Operation	Checker LED display
<b>Amp power ON</b>	(Reverse operation set) Single blink (Single confirmation beep)  (Only brake operation set) Double blink (Two confirmation beeps) 
 <b>High point</b> Forward	Off
 <b>Neutral point</b>	On *Becomes brighter nearer the high point.
 <b>Reverse /brake</b> <b>Brake MAX point</b>	Off
<b>(Amp power left on alarm)</b> When the transmitter power was turned off first.	Blinks. (Confirmation beep also sounds.)  *Not used with PCM receivers. *When the transmitter is OFF, this function is not performed in environments such that the servo operates erroneously.

\* Confirmation beep only sounds when the motor was connected.

\*Specifications and ratings are subject to change without prior notice.

## Ratings

### Communication method:

One-way operation system

### Maximum operating range:

80m (Optimum condition)

### For safety:

F/S (Throttle), ID (About 4 billion ways of pair identifications)

---

### Transmitter T3PRKA

(FHSS system, wheel type, 3 channels)

### Transmitting frequency:

2.4GHz band

### Power requirement:

(Dry cell battery) Penlight x 4(6V)

### Current drain:

100mA or less

### Transmission antenna:

1/2λ di-pole (Built-in)

---

### Receiver R203GF:

(FHSS/S-FHSS system, 3 channels)

### Power requirement:

4.8V ~ 7.4V Rechargeable battery

### Size:

26x39x10mm (excluding a projection part)

### Weight:

8g

---

### Servo S3003

(Standard servo)

### Power requirement:

6V (common with receiver)

### Current drain:

8mA (at 6V / Idle)

### Output torque:

4.1kg-cm (57in.-oz.) at 6V

### Operating speed:

0.19sec/60 degree at 6V

### Size:

40.4x19.8x36mm (1.59x0.78x1.42in.)

### Weight:

37.2g (1.31oz.)

---

### Servo S3050

(Standard digital servo)

### Power requirement:

6V (common with receiver)

### Current drain:

8mA (at 6V / Idle)

### Output torque:

6.5kg-cm (90.3oz.-in.) at 6V

### Operating speed:

0.16sec/60 degree at 6V

### Size:

40.0x20.0x38.1mm (1.57x0.79x1.50in.)

### Weight:

49g (1.72oz.)

---

### E.S.C. MC230CR / MC330CR

(Electronic speed control)

### Operating system:

Forward, reverse, and brake operations are all linear.

### Power requirement:

Ni-Cd/Ni-MH battery 6-7 cells (7.2 to 8.4V)

### PWM frequency:

1.5kHz (fixed)

### Setting:

One-touch input by pushbutton switch. Set data is saved to built-in EEPROM.

### Current capacity (FET rating):

Forward=90A/200A, reverse=45A/100A

### Size:

27.1x33.3x12.8mm (1.07x1.31x0.50in.)  
(excluding protruding parts)

### Silicon cord gauge size:

AWG16/AWG14 equivalent

### Weight:

44/45g (1.55/1.59oz.)  
(including connectors and switches)

### BEC voltage:

6.0V

**NOTE:** Futaba FHSS system, T3PRKA transmitter and R203GF receiver, does not work with current Futaba FASST system. Please use T3PRKA and R203GF in pairs. Futaba FASST system and FHSS system are not compatible each other.

# Troubleshooting

If your system fails to operate or you experience a short range problem or erratic control, check the table below for possible causes. If after you have followed the suggestions listed the problem is not corrected, return the system to our service department for inspection and repair.

(Item Check)

## Transmitter

### Battery

- Dead battery → Change the batteries.
- Batteries inserted incorrectly. → Reload the batteries in accordance with the polarity markings
- Faulty contact → Check to see if the contacts are bent and not making good contact
- Dirty contacts → Clean the contacts and check for corrosion.

## Receiver

### Battery

- Dead battery → Replace or recharge
- Wrong polarity → Check connections

### Antenna

- Near other wiring → Move away from wiring
- Was antenna cut → Request repair
- Is the antenna installed correctly → Refer to the receiver installation.

### Monitor LED

- Check the LED of the receiver.
- Refer to the "How to link the transmitter and the receiver".

## Connector connections

- Wiring incorrect → Insert all connectors firmly
- Loose connections → Push the connector in firmly

## Linkage

- Binding or loose → Adjust the linkage in model
- Is movement stiff → Adjust linkage in model

## Motor (Electric powered)

- Noise problems → Install capacitors on motor

## Error Displays

### Low Battery

When the LED starts blinking, replace the batteries immediately.

LED light:

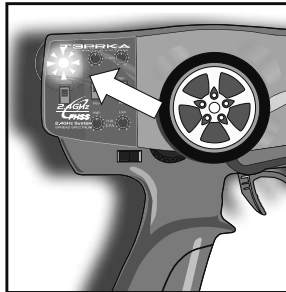

#### **⚠ WARNING**

**!** When a low battery alarm is generated, cease operation immediately and retrieve the model. If the battery goes dead while in operation, you will lose control.

## When requesting repair

Before requesting repair, read this instruction again and recheck your system. Should the problems continue, request as follows.

(Information needed for repair)

Describe the problem in as much detail as possible and send the letter along with the system in question.

- Symptom (Including the conditions and when the problem occurred)
- R/C System (Send transmitter, receiver and servos)
- Model (Type of model, brand name and model number or kit name)
- Detailed packing list (Make a list of all items sent in for repair)
- Your name, address and telephone number.

(Warranty)

Read the Warranty card.

- When requesting warranty service, send the card or some type of dated proof of purchase.

## FEDERAL COMMUNICATIONS COMMISSION INTERFERENCE STATEMENT (for U.S.A.)

This equipment has been tested and found to comply with the limits for a Class B digital device, pursuant to Part 15 of the FCC Rules. These limits are designed to provide reasonable protection against harmful interference in a residential installation.

This equipment generates, uses and can radiate radio frequency energy and, if not installed and used in accordance with the instructions, may cause harmful interference to radio communications. However, there is no guarantee that interference will not occur in a particular installation. If this equipment does cause harmful interference to radio or television reception, which can be determined by turning the equipment off and on, the user is encouraged to try to correct the interference by one or more of the following measures:

- Reorient or relocate the receiving antenna.
- Increase the separation between the equipment and receiver.
- Connect the equipment into an outlet on a circuit different from that to which the receiver is connected.
- Consult the dealer or an experienced radio/TV technician for help.

### CAUTION:

To assure continued FCC compliance: Any changes or modifications not expressly approved by the grantee of this device could void the user's authority to operate the equipment.

### Exposure to Radio Frequency Radiation

To comply with FCC RF exposure compliance requirements, a separation distance of at least 20 cm must be maintained between the antenna of this device and all persons. This device must not be located or operating in conjunction with any other antenna or transmitter.

