



Maritime

Thermal Night Vision Systems



See at Night.

When work is Living on the Water

When you work in the maritime industry visibility and situational awareness are always paramount. Just because the sun sets, fog rolls in, or swells rise doesn't mean you have the luxury of punching the clock and heading home for the day. In fact, the services you provide on inland waterways, in harbors and ports, or offshore may be most necessary when conditions are at their worst.

FLIR thermal night vision technology is available to keep you safe all day, every day, whether you own a single fishing boat, a few tugs, or a fleet of barges and tankers. Professional mariners and militaries around the world have been utilizing FLIR thermal night vision for years to save lives, avoid obstructions, and deter piracy. Now that same technology is available for every vessel, from the palm of your hand to the dashboard in your wheelhouse:

- **First Mate II:** Affordable, handheld thermal imaging for every boater, now featuring the InstAlert™ detection palette
- **MD-Series:** Affordable, fixed mounted cameras, ideal for collision avoidance and vessel security
- **M-Series:** FLIR's family of premier pan and tilt, single and multi-sensor cameras are ideal for collision avoidance and situational awareness on the water
- **Voyager:** 2 thermal imagers, 1 low-light color camera and full gyro-stabilization.

Why Thermal is Better

Thermal imaging cameras detect and display tiny differences in heat, not light. So no matter how much light is available—from pitch black to moonlight to severe midday glare—thermal imagers display clear infrared video. The “detectors”—the key to FLIR technology for decades—pick up the thermal energy emitted by everything, even ice! FLIR cameras then convert that data into the crisp infrared video you see on the display.



Your Vision



FLIR Vision



First Mate II



MD-Series



M-Series



Voyager Series

Stay Safe.

How FLIR Helps You Stay Safe

Collision Avoidance - Crystal-clear video helps you see natural and man-made hazards such as buoys, floating debris, rocks, land, bridge abutments, and other vessels night and day.

Security - The U.S. and international militaries use thermal imaging extensively for counter-piracy efforts. FLIR maritime thermal night vision systems alert your crew to approaching vessels early enough so that they can take evasive measures, call for help, or try to escape to a safe location.

Finding People In The Water - Thermal imagers see the difference in heat between the head of a person in the water and the surrounding water. No other technology available finds people in the water faster.

Complement Existing Systems - Visually verify radar returns with your thermal imager and see things that radar or a chart plotter can't. FLIR thermal imagers plug into existing video displays with standard video connections.



Respond to HAZMAT emergencies
640 x 480

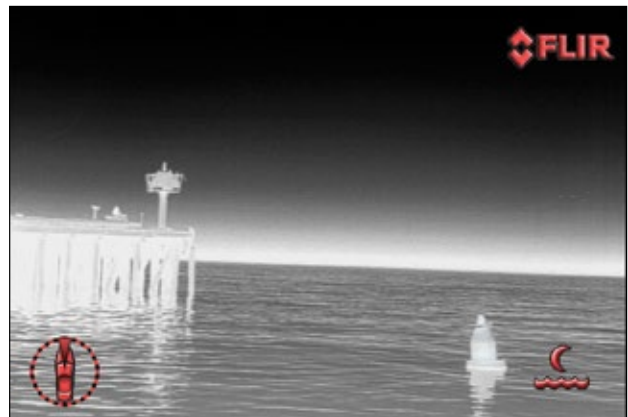

Identify buoys and other obstacles in the water
320 x 240

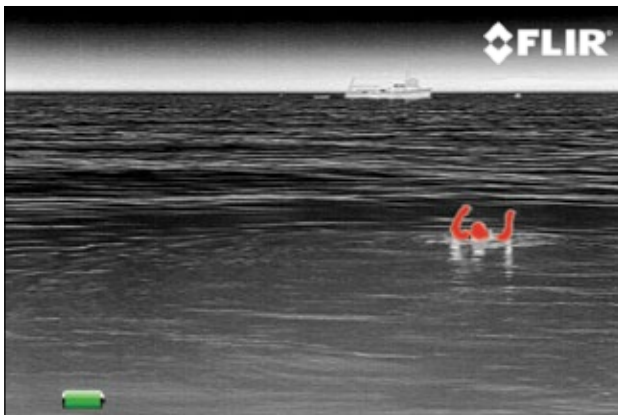

Find crew overboard faster
320 x 240



Locate other vessels
320 x 240

See at Night.

A Camera for Every Vessel

All FLIR thermal night vision cameras let you see clearly in total darkness, but you can also get color or lowlight cameras, gyro stabilization, radar interfacing and other helpful features. Which FLIR is right for you?

- How far do you need to see?
- Are you going to integrate with your other on-board systems?
- Do you want to be able to take it off of your boat?

First Mate II-Series (MS, HM & BHM)

- Handheld
- Bi-ocular models offer comfortable long-term, long-range surveillance options
- Complements other thermal cameras
- Use it anywhere: Docking assistance, vessel inspection, search and rescue, situational awareness, off boat



Thermal Range Performance†

MS-224 & HM-224 Pro (24° Lens)

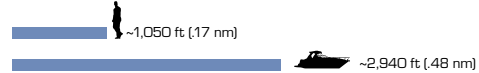

MS-324, & HM-324 XP+ (24° Lens)

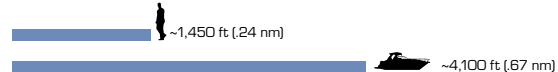

HM-324 XP+ with 2x Extender†† (12° Lens)



HM-307XP (7° Lens)



BHM-X

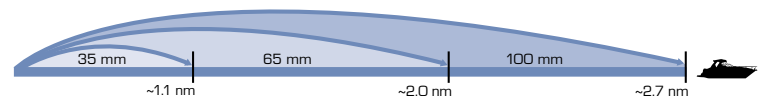
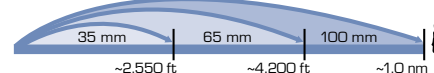

BHM-XR

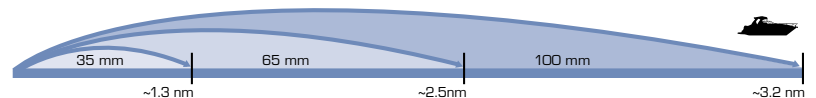
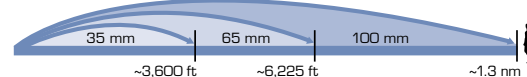

† = Actual object detection range performance may vary depending on camera set-up, environmental conditions, user experience, and type of display used.

†† - 2x Extender pertains to HM-Series only

All specifications are subject to change without notice.

Stay Safe.

MD-Series

- Affordable, fixed mount thermal imager
- Easy install and use
- Standard & high resolution thermal camera options
- Ethernet-enabled



Thermal Range Performance[†]

MD-324[†]



MD-625[†]



M-Series

- Premium pan/tilt thermal imager
- Thermal only or thermal/lowlight multi-sensor configurations
- Standard- and high-resolution thermal camera options
- Network-ready
- Auto-scan feature
- Easy to use joystick control

Thermal Range Performance[†]

M-324L & M-324XP



M-625L & M-625XP



M-618CS



Voyager Series

- Long-range
- Gyro-stabilized pan/tilt platform
- 2 thermal cameras
- Daylight/lowlight color camera
- Network-ready
- NMEA interfaces
- Radar slew-to-cue
- Video Tracker
- IP Addressability
- Temperature indication

Thermal Range Performance[†]

Voyager III



See at Night.

First Mate II MS-Series



First Mate II MS-Series Control Panel

Display:
Brightness Adjustment

Polarity:
Toggle Between Palettes:

- White hot
- Black hot
- InstAlert



Power

USB Port

Zoom/Freeze Frame*

* These features available on specific camera configurations

Ultra-compact and loaded with features, First Mate II MS-Series literally fits in the palm of your hand. Keep one in your pocket or in an easy-to-reach spot on your vessel. MS-Series is effective as your only thermal imaging device or as a complement to your mounted thermal imaging system because you can take it anywhere on the boat and everywhere off of it.

Go-Anywhere Thermal Night Vision

First Mate II isn't mounted permanently on your boat, so you can use it to see at night everywhere!



Portable thermal systems go anywhere



Observe Wildlife: Great for camping & hiking



NEW: InstAlert™

Stay Safe.

Key Features:

- **InstAlert detection:** By adding a red highlight to the hottest elements in a scene, day or night, the First Mate II will help you locate a man overboard faster than any other technology available.
- **Easy to use:** One-handed, push-button functionality means you can steer or point with one hand while zooming or switching palettes on your MS-Series with the other.
- **Compact & dependable:** Only 12 ounces. Less than 7 inches long. IP-67 rated, submersible to 1 meter. You'll rely on it often, night and day.



Thermal Imaging Specifications	MS-224	MS-324
Detector Type	240 x 180 VOx Microbolometer	320 x 240 VOx Microbolometer
FOV	24° x 18°	
Focal Length	19 mm	
Waveband	7.5 - 13.5 μm	
Start-up Time	< 5 seconds	
Focus	Fixed	
Image Processing	FLIR Proprietary Digital Detail Enhancement	
User Interface		
Power Button	On/Off	
Picture Button	N/A	N/A
Zoom Button	Freeze Frame	2x E-Zoom
Polarity	Toggles White Hot, Black Hot, InstAlert	
Brightness	Adjusts Display Brightness	
Image Presentation		
Built-In Display	Color LCD Display	
Video Output	N/A	N/A
Video Refresh Rate	<9 Hz	
Image Polarity	White Hot; Black Hot; InstAlert	
Power		
Battery Type	Internal Camera Battery / Li-Ion	
Battery Life (Operating)	5 Hours + (typical)	
Battery Life (Stand-By)	N/A	
Environmental		
Rating	IP-67 - Submersible to 1 meter	
Operating Temp.	-4°F to 122°F (-20°C to 50°C)	
Physical		
Weight (incl. lens)	12 oz (340 g)	
Size (L x W x H)	6.70" x 2.31" x 2.44" (172 x 58.7 x 62 mm)	
Packages Include	First Mate MS Handheld Maritime Thermal Night Vision Camera, Wrist Strap, Product CD, Drawstring Pouch	
Thermal Range performance†		
Detect Man (1.8 m x 0.5 m)	~1,050 ft (0.17 nm)	~1,450 ft (0.24 nm)
Detect Small Vessel (2.3 m x 2.3 m)	~2,940 ft (0.48 nm)	~4,100 ft (0.67 nm)
Warranty	3 Year (with product registration)	

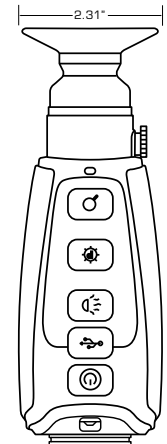
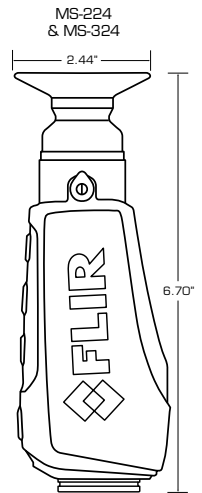

See at Night.

First Mate II HM-Series



The most versatile thermal handheld available, First Mate II HM-Series can be customized to achieve optimal performance for you. Resolution and optics configuration options enable you to detect a person 1,050 feet away with HM-224 or up to 5,000 feet away with HM-307 XP+. Still image and video storage is available if you need it. And length and weight are also variable depending on lens choice or if you want the optional 2x extender. You can configure your HM-Series to how you want to use it on your boat, as well as at home or on the trail.

Key Features:

- **InstAlert detection:** By adding a red highlight to the hottest elements in a scene, day or night, the First Mate II will help you locate a man overboard faster than any other technology available.
- **Video out:** Connect a video monitor to HM-Series' RCA jack to view or record NTSC or PAL composite video.
- **SD card capability:** HM-224 Pro, HM-324XP+ and HM-307XP+ offer image/video storage.
- **Compact & dependable:** Submersible to 1 meter. You'll rely on it often, night and day.

First Mate II HM-Series Control Panel

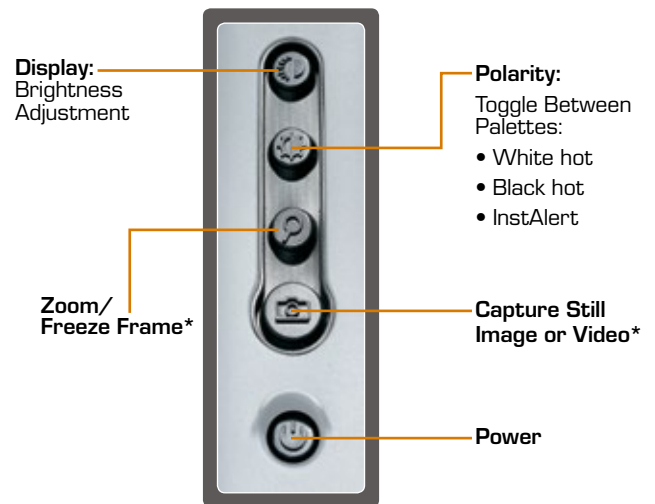

* These features available on specific camera configurations



Home Security: Investigate strange noises

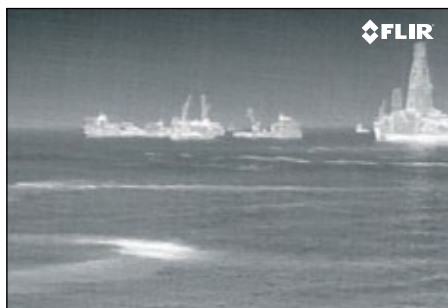

Work Safer - Avoid situational hazards

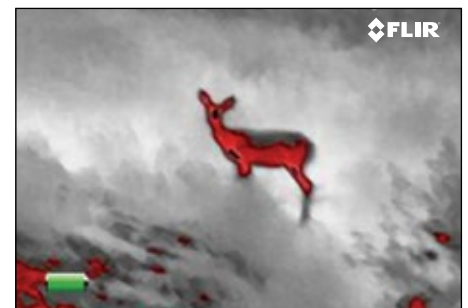

NEW: InstAlert™

Stay Safe.

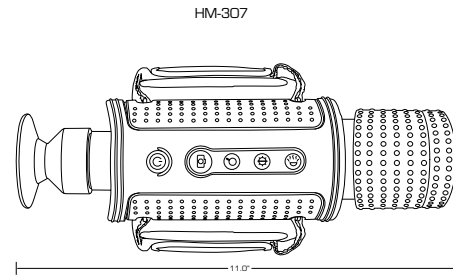
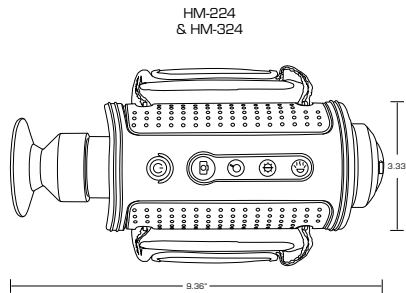

Thermal Imaging Specifications	HM-224	HM-224 Pro	HM-324 XP+	HM-307 XP+
Detector Type	240 x 180 VOx Microbolometer		320 x 240 VOx Microbolometer	
FOV	24° x 18° NTSC		7° x 5° NTSC	
Focal Length	19 mm		65 mm	
Waveband	7.5 - 13.5 μm			
Start-up Time (From Stand-By)	< 5 seconds			
Focus	Fixed			
Image Processing	FLIR Proprietary Digital Detail Enhancement			
User Interface				
Power Button	On/Off/Stand-By			
Picture Button	Freeze Frame	Still image capture and video capture to SD card		
Zoom Button	N/A	2x E-Zoom		
Polarity	Toggles White Hot, Black Hot, InstAlert			
Brightness	Adjusts Display Brightness			
Image Presentation				
Built-In Display	Color LCD Display			
Video Output	NTSC or PAL composite video; RCA jack			
Video Refresh Rate	<9 Hz			
Image Polarity	White Hot; Black Hot; InstAlert			
Other				
SD Card	—	Stores still images	Stores still images and video	Stores still images and video
Power				
Battery Type	4 Rechargeable AA Batteries; NiMH, Li-Ion, or Alkaline			
Battery Life (Operating)	>5 Hours On NiMH batteries			
Battery Life (Stand-By)	120 Hours on NiMH batteries			
Environmental				
Rating	IP-67			
Operating Temp.	32°F to 122°F (0°C to 50°C)		-4°F to 122°F (-20°C to 50°C)	
Physical				
Weight (incl. lens)	1.45 lb (653 g) with batteries		2.2 lb (984 g) with batteries	
Size (L x W x H)	9.36" x 3.33" x 2.6" (10.5" x 3.3" x 2.6" w/ Extender)		11" x 3.33" x 2.62" (279.4 x 84.5 x 66.5 mm)	
Packages Include	HM-Series Handheld Thermal Camera, Hot Shoe Charging & Video Output Accessory, 4 Rechargeable AA Batteries, AC Power Adapter/Charger, Neck Lanyard, Operator's Manual, Video Output Cable.			
Thermal Range Performance†				
Detect Man (1.8 m x 0.5 m)	~1,050 ft (0.17 nm)		~1,600 ft (0.26 nm)	~4,800 ft (0.79 nm)
Detect Small Vessel (2.3 m x 2.3 m)	~2,940 ft (0.48 nm)		~4,900 ft (0.80 nm)	~2 nm
Warranty	3 Year (with product registration)			

See at Night.

First Mate II BHM-Series



Bi-ocular comfort, interchangeable lenses, and the availability of a high-resolution 640 x 480 detector make First Mate II BHM-Series a favorite for professional mariners. Both models come standard with a video out connection so it's easy to connect to an onboard monitor or DVR during surveillance, to verify radar returns, or to improve situational awareness in the absence of a mounted thermal imaging system.

Key Features:

- **InstAlert detection:** By adding a red highlight to the hottest elements in a scene, day or night, the First Mate II will help you locate a man overboard faster than any other technology available.
- **Interchangeable lenses:** Three lenses for the BHM-Series are sold separately: 35 mm, 65 mm, and 100 mm.
- **Bi-ocular design:** This unique feature reduces eye strain during long missions, is easier to hold steady on rough waters, and gives you greater range performance.

First Mate II BHM-Series Control Panel

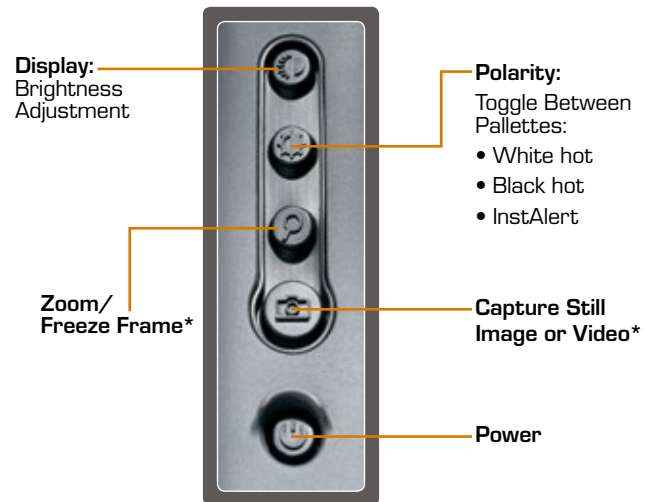

Situational Awareness in-hand

First Mate II isn't mounted permanently on your boat, so you can use it to see at night everywhere!



See the position of other Vessels



Avoid out-croppings & dangerous shorelines

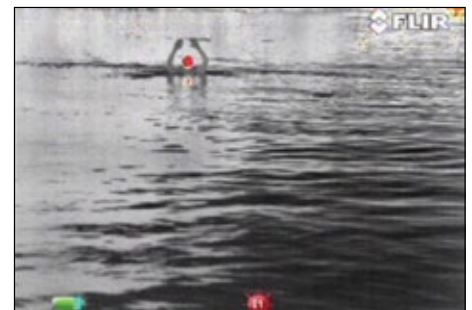

NEW: InstAlert™

Stay Safe.

BHM-Series

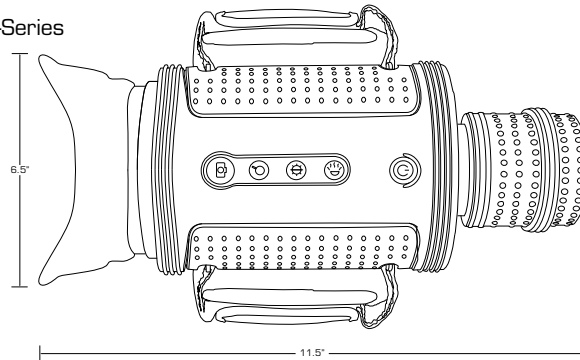

System	BHM-X+ (35 mm)	BHM-XR+ (35 mm)	BHM-X+ (65 mm)	BHM-XR+ (65 mm)	BHM-X+ (100 mm)	BHM-XR+ (100 mm)
FOV	13° x 10° NTSC	18° x 13° NTSC	7° x 5° NTSC	10° x 8° NTSC	5° x 3° NTSC	6° x 4° NTSC
Start-up from Standby	< 1.5 seconds					
Waveband	7.5 - 13.5 μm					
Detector Type	320 x 240 VOx Microbolometer	640 x 480 VOx Microbolometer	320 x 240 VOx Microbolometer	640 x 480 VOx Microbolometer	320 x 240 VOx Microbolometer	640 x 480 VOx Microbolometer
Image Processing	FLIR Proprietary Digital Detail Enhancement					
User Interface						
Power Button	On/Off/Standby					
Picture Button	Still & Video image capture to SD card					
Zoom Button	2x E-zoom	2x & 4x E-zoom	2x E-zoom	2x & 4x E-zoom	2x E-zoom	2x & 4x E-zoom
Polarity	Black Hot/White Hot/Marine Red/InstAlert					
Brightness	Adjusts Display Brightness					
Image Presentation						
Built-In Display	LCD Display					
Video Output	NTSC or PAL composite video; RCA jack					
Video Refresh Rate	<9 Hz or 30 Hz (NTSC and PAL)					
Image Polarity	White Hot/Black Hot/Marine Red/InstAlert; Selectable					
Other						
SD Card	Stores still images and video					
Power						
Battery Type	4 AA Batteries; NiMH, Li-Ion, or Alkaline					
Battery Life (Operating)	>5 Hours On NiMH batteries					
Battery Life (Stand-By)	120 hours on NiMH batteries					
Environmental						
Rating	IP-67, Submersible					
Operating Temp.	-4°F to +140°F (-20°C to +50°C)					
Storage Temp.	-40°F to +167°F (-40°C to +70°C)					
Drop	1 m drop (camera body only)					
Physical						
Weight (incl. lens)	2.84 lb (1290 g) with batteries		3.05 lb (1380 g) with batteries		3.06 lb (1390 g) with batteries	
Size (L x W x H)	10.5" x 3.3" x 2.6"		11.5" x 3.3" x 2.6"		13.0" x 3.3" x 2.6"	
Packages Include	Handheld Thermal Camera, Hot Shoe Charging & Video Output Accessory, 4 Rechargeable AA Batteries, AC Power Adapter/Charger, Neck Lanyard, DVD with Operators manual, USB Cable, RCA Video Output Cable, SD Card, Quick Start Guide, Hardshell Case, Tactical Carry Pouch (optional)					
Range Performance†						
Detect Man (1.8 m x 0.5 m)	~2,550' (.41 nm)	~3,600' (.59 nm)	~4,200' (.69 nm)	~6,225' (.95 nm)	~1.0 nm	~1.3 nm
Detect Small Vessel (2.3 m x 2.3 m)	~1.1 nm	~1.3 nm	~2.0 nm	~2.5 nm	~2.7 nm	~3.2 nm
Warranty						
2 Year						

† = Actual object detection range performance may vary depending on camera set-up, environmental conditions, user experience, and type of display use.

See at Night.

MD-Series

This affordable, fixed-mount thermal night vision system helps with steering around obstacles, collision avoidance and finding people in the water at night. Simple to mount and easy to integrate into your existing electronics, MD-Series' outputs standard analog video that can be easily displayed on any monitor at the helm or other monitors on the vessel.

Key Features:

- Available in 320 x 240 and 640 x 480 resolutions
- 2x e-zoom standard; 4x e-zoom included on MD-625
- Ethernet-enabled for simple integration into your current electronics
- Compact, all weather, water proof enclosure provides for easy mounting options
- Ball up or ball down mounting options



Thermal Imaging Specification	MD-324	MD-625
Sensor Type	320 x 240 VOx Microbolometer	640 x 480 VOx Microbolometer
FOV	24° x 18° (NTSC)	25° x 20° (NTSC)
Focal Length	19 mm	25 mm
E-zoom	2x	2x, 4x
Image Processing	FLIR Proprietary Digital Detail Enhancement	
System Specifications		
Size	6" dia. x 7" ht.	
Weight	~ 3 lbs	
Pan/Tilt Adjustment Range	Pan: ±30° per key, Tilt: +34°, -27° (Locked in at Installation)	
Video Output	NTSC or PAL, 30 Hz or <9 Hz	
Connector Types	F-type BNC with BNC-to-RCA adapter included for video out	
Power Requirements	PoE injector required per IEEE 802.3af	
PoE Injector Power Requirement	12-24 VDC	
Power Consumption	4.8 W nominal; 12.5 W max	
Environmental		
Operating Temperature Range	-13°F to +131°F (-25°C to +55°C)	
Storage Temperature Range	-40°F to +185°F (-40°C to +85°C)	
Automatic Window Defrost	Standard at Power-Up	
Sand/Dust	Mil-Std-810E	
Water Ingress	IPx6 (heavy seas, powerful jets of water)	
Shock	15 g vertical, 9 g horizontal	
Vibration	IEC 60945; MIL-STD-810E	
Lightning Protection	Standard	
Salt Mist	IEC60945	
Wind	100 knot (115.2 mph)	
EMI	IEC 60945	
Thermal Range Performance		
Detect Man (1.8 m x 0.5 m)	~1,500 ft (0.24 nm)	~2,700 ft (0.44 nm)
Detect Small Vessel (2.3 m x 2.3 m)	~4,200 ft (0.67 nm)	~1.2 nm
Standard Package		
Camera Head with 11" pigtails, 25' Analog Video cable, 25' Ethernet cable, PoE injector and Operator Manual CD		
Warranty		
3 Year (with product registration)		
Optional Accessories		
Low Smoke Zero Halogen Ethernet Cables		

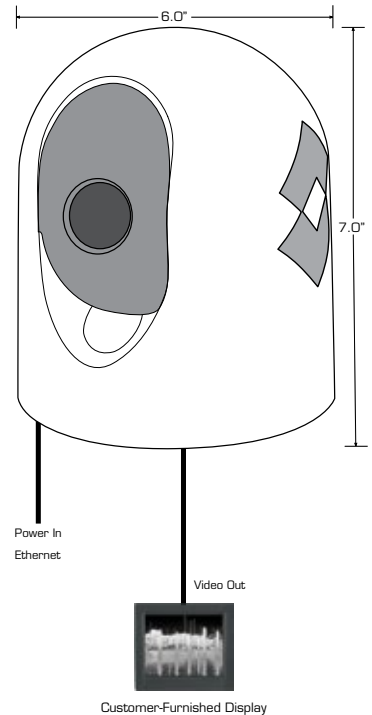

Stay Safe.

M-Series®

The award-winning M-Series is FLIR's premium line of maritime thermal night vision systems. Available with a variety of sensors and resolutions to customize for your work on inland waterways, ports and harbors, off shore, M-Series is easy to install, integrate and operate.

M-Series systems use Ethernet connectivity for easy installation, control, and interface with other onboard electronics. The rugged, waterproof gimbal enclosure provides a continuous 360° pan and a +/-90° tilt field of regard.



Dual payload M-Series with thermal and low-light cameras

Single payload M-Series with thermal camera



Black hot

White hot



Red hot

Fusion

Rainbow



High-resolution detail image



Low-light Video

Key Features:

- Available in 320 x 240 standard resolution or 640 x 480 high-resolution thermal vision (higher resolution provides improved image detail and range performance).
- 2x e-zoom standard on all models (high-resolution models also include 4x e-zoom).
- Mount ball-up or ball-down.
- Dual-payload versions include extreme lowlight micro-lux TV camera for improved visibility in low ambient light.
- M-618CS gyro-stabilization provides steady imagery even in rough seas. Mounts ball-up only.
- On-screen position feedback.

See at Night.

Joystick Control Unit

Ergonomic, effortless control of all critical M-Series functions, even in rough conditions

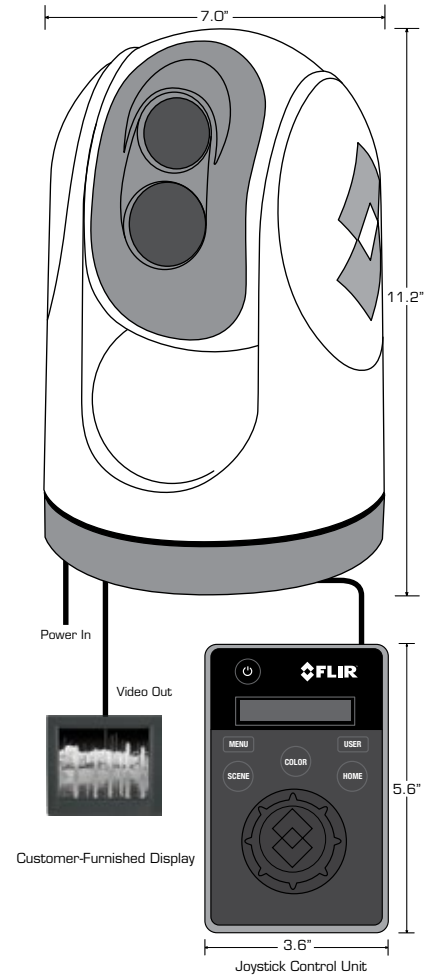
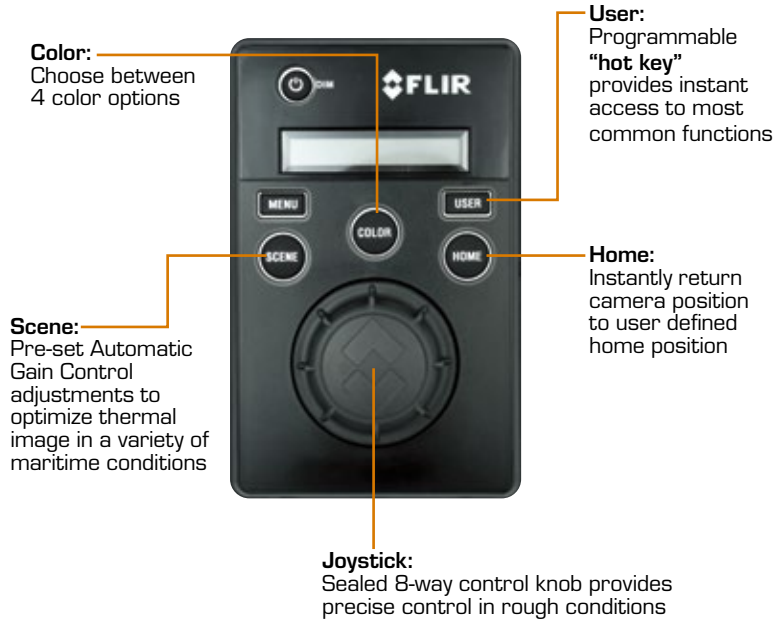

Other Features:

- **Heated LCD Screen:** Instant, always legible system status display.
- **Auto Scan Controls:** Program automatic scan speed and pointing angle arc ranging from 40° to 160°
- **Ethernet Connectivity:** Install multiple control stations to control M-Series from anywhere on your vessel



On-Screen Icons

M-Series uses FLIR's color on-screen symbology to let you see where the system is pointing, and to give you instantaneous updates regarding the camera's configuration and status.

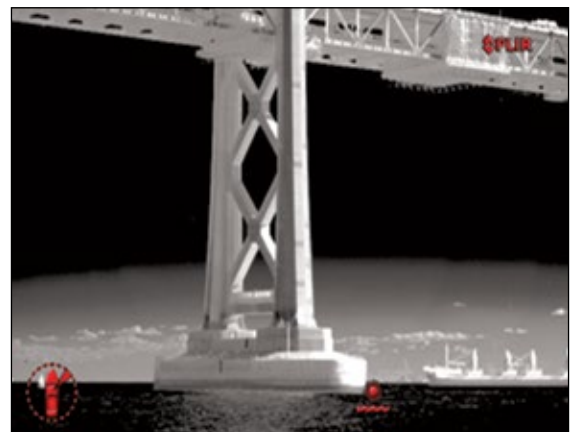

Stay Safe.

M-Series



Thermal Imaging Specifications	M-324XP	M-625XP	M-324L	M-625L	M-618CS
Sensor Type	320 x 240 VOx Microbolometer	640 x 480 VOx Microbolometer	320 x 240 VOx Microbolometer	640 x 480 VOx Microbolometer	640 x 480 VOx Microbolometer
FOV	24° x 18° (NTSC)	25° x 20° (NTSC)	24° x 18° (NTSC)	25° x 20° (NTSC)	18° x 14° (NTSC)
Focal Length	19 mm	25 mm	19 mm	25 mm	35 mm
E-zoom	2x	2x & 4x	2x	2x & 4x	2x & 4x
Image Processing	FLIR Proprietary Digital Detail Enhancement				
Daylight Imaging Specifications					
Detector Type		N/A	1/2" Interline Transfer Lowlight CCD		Color CCD
Lines of Resolution		N/A	768 (H) x 494 (V)		530
Minimum Illumination		N/A	100 µlx (@ f/1.4)		1.4 lux
FOV		N/A	Matched to IR		~58° (h) x 43° (V) w/10x optical zoom matched to IR
System Specifications					
Size			7" dia. x 11.2" ht.		7" dia. x 11.4" ht.
Weight			~ 9 lbs		~ 11.5 lbs
Pan/Tilt Coverage			360° Continuous Pan, +/-90° Tilt		
Video Output			NTSC or PAL		
Connector Types			BNC with BNC-to-RCA adapter included for video out		
Power Requirements			12 VDC to 24 VDC (-10%/+30%)		
Power Consumption			25 W nominal; 50 W max		
Environmental					
Operating Temperature Range			-13°F to +131°F (-25°C to +55°C)		
Storage Temperature Range			-40°F to +185°F (-40°C to +85°C)		
Automatic Window Defrost			Standard		
Sand/Dust			Mil-Std-810E		
Water Ingress			IPx6 (heavy seas, powerful jets of water)		
Shock			15 g vertical, 9 g horizontal		
Vibration			IEC 60945; MIL-STD-810E		
Lightning Protection			Standard		
Salt Mist			IEC60945		
Wind			100 knot (115.2 mph)		
EMI			IEC 60945		
Thermal Range Performance¹					
Detect Man (1.8 m x 0.5 m)	~1,500 ft	~2,700 ft (0.44 nm)	~1,500 ft (0.24 nm)	~2,700 ft (0.44 nm)	~3,900 ft (0.64 nm)
Detect Small Vessel (2.3 m x 2.3 m)	~4,200 ft	~1.2 nm	~4,200 ft (0.67 nm)	~1.2 nm	~1.7 nm
Standard Package					
	Camera Head with 18-inch Pigtailed for Power, Analog Video, and Ethernet; Joystick Control Unit; 25' LSZH Ethernet Cable, Operator Manual				
Warranty					
	3 Year (with product registration)				
Optional Accessories					
	Dual Station JCU; Low Smoke Zero Halogen Ethernet Cables; Top-Down Mounting Riser				

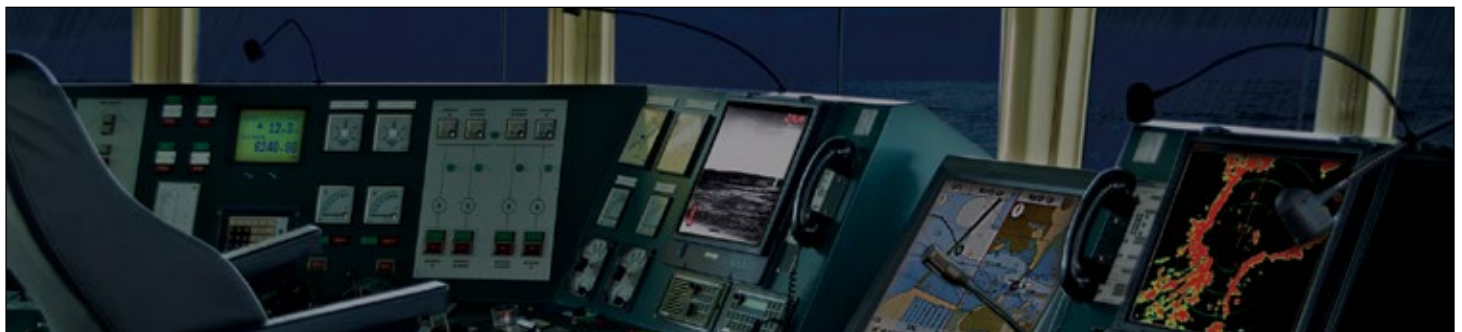

See at Night.

Voyager Series



Long-Range Multi-Sensor Thermal Night Vision Systems

With two best-in-class thermal night vision cameras, and a dual-function daylight/lowlight color TV camera that lets you see harbor entrances and identify vessels and their intentions clearly in the half-light of dawn and dusk, the award-winning Voyager provides 24-hour imaging capability that lets you see to the horizon.

Voyager's wide-angle thermal camera easily detects other boats or hazards, while its long-range 140 mm thermal camera lets you zoom in to see if anyone is in harm's way, to verify radar returns, and to give you plenty of time to react. Voyager is the proven anti-piracy system of choice for commercial mariners around the world.

Key Features:

Voyager II & III

- **4x optical zoom & 15x total zoom:** Voyager II & III lets you see even farther at night
- **Powerful, long-range daylight/lowlight color TV camera:** With 26x optical zoom, and 312x digital zoom
- **Active gyro-stabilization:** Provides steady imagery, even in rough seas, which is critical for getting the most out of Voyager's long range imaging capability
- **Radar Tracking†:** Identify and track specified radar returns
- **Internet remote control:** Operates Voyager from anywhere in the world with a suitable Internet connection
- **Expanded interface capability:** Integrates Voyager feed with other marine electronics

Voyager III

- **Video Tracker:** Automatically stays locked onto an object or vessel to follow its every movement
- **Temperature Indication Scale:** Determines temperature of objects in image
- **Surveillance Mode:** Automatically pans left and right

† = Some Maritime Radars do not output the NMEA 0183 data required for this feature.



Voyager Zoom



Stay Safe.

Voyager III Joystick Control Unit

Ergonomic, effortless control of all critical Voyager III functions, even in rough conditions



On-Screen Icons

Voyager uses FLIR's color on-screen symbology to let you see where the system is pointing, and to give you instantaneous updates regarding the camera's configuration and status.



Black hot

White hot



Video



Red hot

Fusion

Rainbow



Temperature Indication



Foveal View

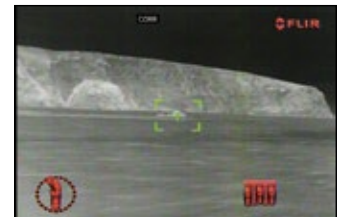

Video Tracker

Other Features:

- **Heated LCD Screen:** Instant, always legible system status display.
- **Auto Scan Controls:** Program automatic scan speed and pointing angle arc ranging from 40° to 160°
- **Ethernet Connectivity:** Install multiple control stations to control Voyager Series from anywhere on your vessel

*Some models of Voyager feature alternate joystick control units.

See at Night.

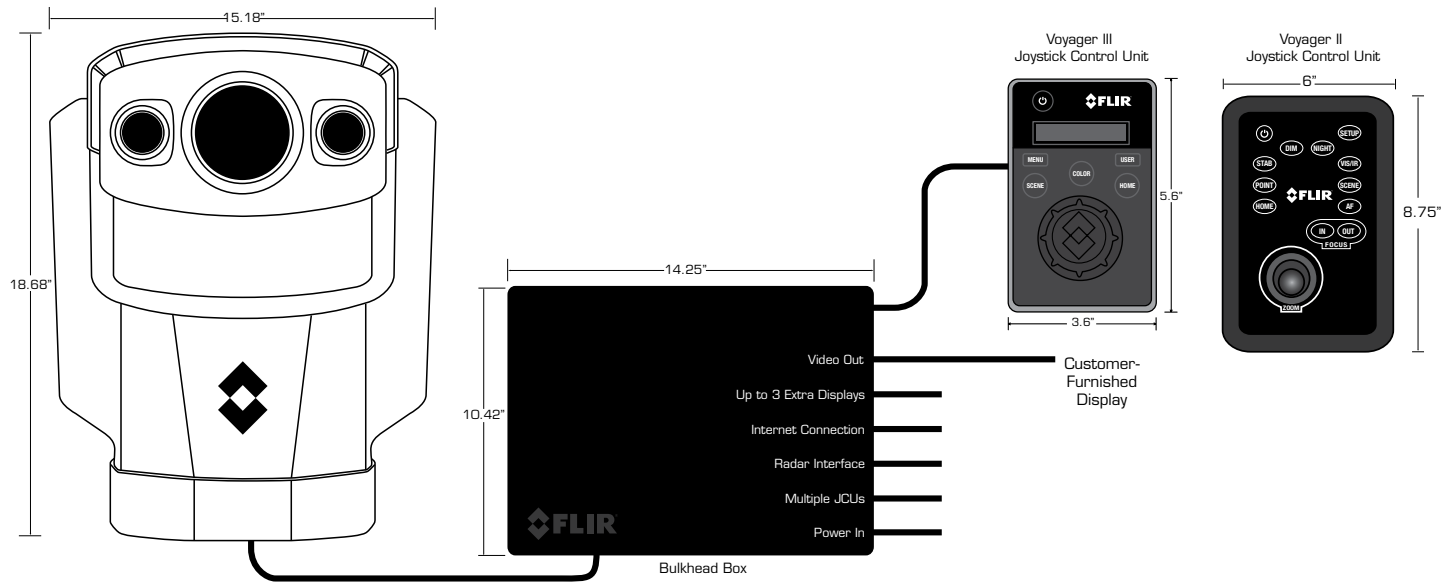

Voyager II & Voyager III

Thermal Imaging Specifications	
Sensor Type	Two 320 x 240 VOx Microbolometers
FOV	20° x 15° (Wide FOV); 5° x 3.75° (Narrow FOV)
Focal Length	35 mm (Wide FOV); 140 mm (Narrow FOV)
E-zoom	4x (15x Total Magnification)
Image Processing	FLIR DDE
Daylight Imaging Specifications	
Detector Type	1/4" Super HAD Daylight/Lowlight Color CCD
Lines of Resolution	768 (H) x 494 (V)
Minimum Illumination	2 lux (@ f/1.6)
FOV	42° (h) to 1.7° (h) plus 12x E-zoom for 312x Total Magnification
System Specifications	
Camera Head Size	15.18" x 18.68"; 15.5" x 22" Swept Volume Cylinder
Bulkhead Box	10.42"(w) x 14.25"(l) x 6.26"(d)
Weight	45 lb
Pan/Tilt Coverage	360° Continuous Pan, +/-90° Tilt
Video Output	NTSC or PAL
Connector Types	BNC
Power Requirements	24 VDC
Power Consumption	<50 W nominal; 130 W peak, 270 W w/heaters
Environmental	
Operating Temperature Range	-4°F to 131°F (-20°C to 55°C)
Storage Temperature Range	-58°F to 176°F (-50°C to 80°C)
Automatic Window Defrost	Standard
Thermal Range Performance†	
Detect Man (1.8 m x 0.5 m)	~1.2 nm
Detect Small Vessel (2.3 m x 2.3 m)	~3.4 nm
Typical Configuration	Camera Head; Bulkhead Box; Joystick Control Unit; Cables; Operator Manual
Warranty	2 Year

Stay Safe.

The Thermal Trend in Commercial Maritime

New applications for infrared thermal imaging in a maritime environment are being discovered every year. As shipping channels become more crowded, global weather patterns continue to shift, and piracy and border disputes spill into commercial shipping, the value of thermal imaging systems grows ever more essential. Here are two samples of thermal imaging technology being used by professional mariners today.



Visible Detection with Spotlighting



Thermal Detection with FLIR



Radar Detection of Icebergs



Thermal image of Icebergs

Iceberg Detection

Arctic and Antarctic waters are dangerous because of long periods of darkness, harsh weather, and icebergs. FLIR thermal imaging systems can take care of the darkness and the iceberg detection. Even icebergs give off heat, and FLIR technology detects the temperature difference between the iceberg and the seawater. Where radar and spotlights fall short, thermal imaging increases vessel efficiency in arctic waters, making passage safer and more cost-effective. Regarding the harsh weather...FLIR thermal night vision can't control a storm, but it can increase situational awareness in rough seas.

Oil Spill Detection

Oil, diesel, and other hazardous chemical spills or leaks can be the sign of impending problems or the result of a disaster. Either way, it's critical that the source and extent of the leak be determined immediately. Infrared thermal imaging can detect floating chemicals even when the naked eye cannot in the middle of the day. FLIR thermal imaging systems can help commercial marines avoid spills or limit their impact, and can assist response crews with clean up around the clock.



Visible spectrum oil slick

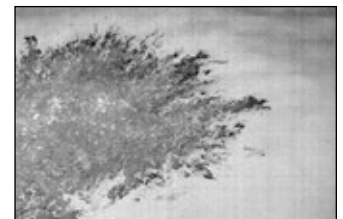

Thermal spectrum oil slick



Oil Detection Research Lab

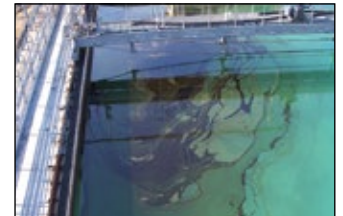

Simulated Oil Spill

See at Night.

Resolution Matters

When people talk about a thermal camera's resolution, they're talking about the number of pixels used to capture thermal energy. The bigger the number, the higher the camera's resolution. The higher the resolution, the more pixels you have gathering energy. This means that a higher resolution camera will typically let you see more detail, see smaller objects, and see them from farther away.



640 x 480

320 x 240

What's a Field of View, and Why Do I Care?

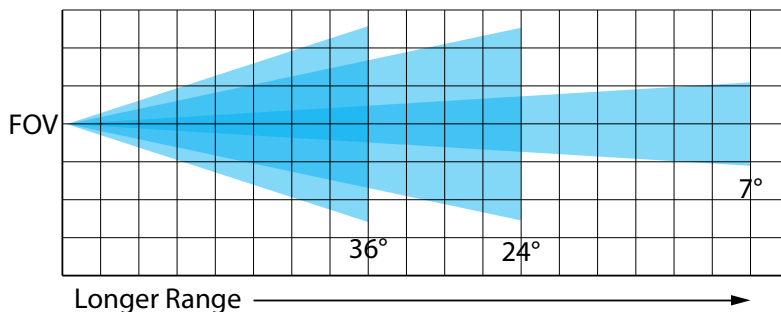

A camera's field of view (FOV) is the angular measurement of the area the lens can see. The wider the FOV the more you can see from side to side; the narrower the FOV the farther away you can see things. So, a 24° FOV is good for general viewing, collision avoidance, and hazard or man overboard detection, while a 7° FOV is better for seeing other vessels, hazards, and obstructions from farther away. While narrower fields of view help you see farther, they need to be steady to be most effective, so they can be more difficult to use as seas get heavier.



19mm lens at 50yds



35mm lens at 50yds



65mm lens at 50yds



100mm lens at 50yds

Stay Safe.

ProMaritime

There's no better way to fully comprehend the power of thermal imaging than to try a camera for yourself. You can also try the First Mate II Product Selector and thermal simulator, read about the different ways thermal imaging is used in a maritime environment, and learn more about all FLIR thermal night vision systems for maritime use.

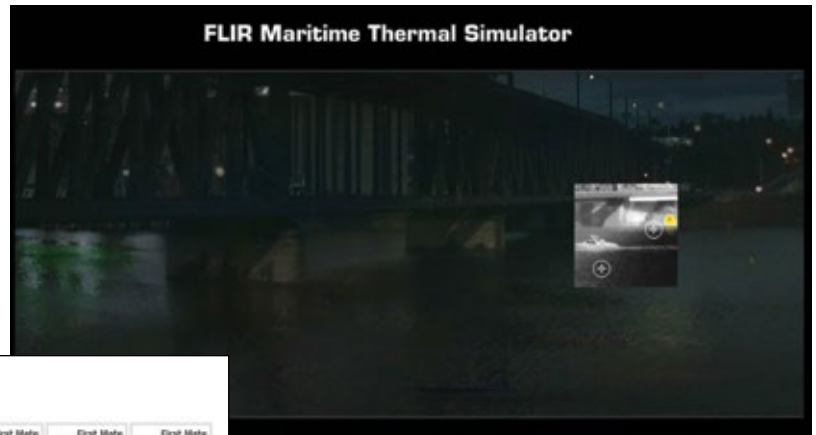

Compare FLIR First Mate Models

Not sure which model is best for you? Select models below to compare.

You have no items to compare.

Filter Options

Range - Detection of a Small Vessel

40 Items \$1,228.00 / \$1,519.00

Detector Resolution

344x256 640x512

320x240 640x480

Digital Still Image Storage

Required Not Required

Digital Video Storage

Required Not Required

Analog Video Out

Required Not Required

Note: Actual range may vary depending on camera setup, environmental conditions, user experience, and display method. Thermal images shown are for illustrative purposes only, and may not have been taken by the camera series depicted.

 First Mate RS-224 Size: 483x100mm	 First Mate RS-324 Size: 483x100mm	 First Mate HR-224 Size: 483x100mm	 First Mate HR-224 Pro Size: 483x100mm	 First Mate HR-324XP+ Size: 483x100mm	 First Mate HR-307XP+ Size: 483x100mm	 First Mate SR94-X+ 20mm Size: 483x100mm
 First Mate SR94-X+ 30mm Size: 483x100mm	 First Mate SR94-X+ 40mm Size: 483x100mm	 First Mate SR94-X+ 50mm Size: 483x100mm	 First Mate SR94-X+ 60mm Size: 483x100mm	 First Mate SR94-X+ 70mm Size: 483x100mm		

Compare products online with the First Mate II Product Selector

About FLIR Systems

As the world's largest commercial infrared company, FLIR Systems has fielded more high-quality maritime thermal night vision systems than anyone in the world. Our rugged, stabilized imagers are on thousands of civil and maritime platforms in the U.S. and around the world, more than every other manufacturer combined.

With thousands of our thermal cameras on the job in military, scientific, law enforcement, and security applications, FLIR brings an unmatched level of experience and dedication to the creation of cutting-edge thermal night vision systems. We design and manufacture all critical technologies inside our products, including detectors, electronics, and special lenses, and we assemble it all right here in the U.S.

Whether you're heading out early, coming home late, or cruising around the clock, FLIR has a thermal night vision system to meet your needs.



View [other Marine Electronics & Navigation made by FLIR Thermal Cameras](#) on our website.