

FISHER[®] RESEARCH
LABS

F22



OWNER'S MANUAL

**Not for Underwater Use
DO NOT SUBMERGE**

Uses two AA **ALKALINE** batteries only.
Do not use "Heavy Duty" batteries.
Do not use ordinary Zinc Carbon batteries.



Congratulations!

Congratulations on the purchase of your new Fisher F22™ Metal Detector. The F22 is the result of many years of software engineering and features the latest advancements in lightweight design and target accuracy. The F22 can be used with its default turn-on-and-go settings, or you can adjust the detector's settings to match your hunting conditions. No longer do you need to fear the weather, the F22 is completely weatherproof. Laugh at the rain. No longer will weather be a force that stops you from enjoying your sport. Treasure hunting enthusiasts from around the world were involved in the development of this revolutionary new detector. This manual has been written to help you get optimal use of your detector so we hope you will read it thoroughly before your first outing.

Happy Hunting from Fisher Research Labs!

The F22 operates at a frequency of 7.69 kHz and comes with a 9" triangulated concentric elliptical searchcoil. The F22 shares searchcoil compatibility with the F11 and F44.

TABLE OF CONTENTS

| | |
|--|-----------|
| Terminology | 3 |
| Contents | 4 |
| Assembly | 5-6 |
| Batteries (use alkaline batteries) | 7 |
| Quick-Start Demonstration | 8 |
| The Basics of Metal Detecting | 9-10 |
| 9" Searchcoil | 10 |
| How to Work the Controls | 11 |
| The Display | 12 |
| Depth Indicator | 12 |
| Overload Warning | 12 |
| Menu | 13 |
| Volume | 13 |
| Sensitivity | 13 |
| Notch | 14 |
| Modes | 14-15 |
| Custom Mode | 14 |
| Pinpoint | 15 |
| How to Pinpoint | 15 |
| Target-ID | 16-17 |
| 4-Tone Target-ID | 16 |
| Depth and Target Display | 18-19 |
| Target Groups and ID Numbers | 18-19 |
| Headphone Jack | 20 |
| Characteristics and Limitations | 21 |
| Troubleshooting | 22 |
| Treasure Hunter's Code of Ethics | 23 |
| Warranty | 23 |
| Accessories | Back Page |

TERMINOLOGY

The following terms are used throughout the manual and are standard terminology among detectorists.

RELIC

A relic is an object of interest by reason of its age or its association with the past. Many relics are made of iron, but can also be made of bronze or precious metals.

IRON

Iron is a common, low-grade metal that is an undesirable target in certain metal detecting applications. Examples of undesirable iron objects are old cans, pipes, bolts and nails. Sometimes the desired target is made of iron. Property markers, for instance, contain iron. Valuable relics can also be composed of iron; cannon balls, old armaments and parts of old structures and vehicles can also be composed of iron.

FERROUS

Metals which are made of, or contain iron.

ELIMINATION

Reference to a metal being "eliminated" means the detector will not emit a tone, nor display a Target-ID, when a metal object passes through the searchcoil's detection field.

DISCRIMINATION

When the detector emits different tones for different types of metals, and when the detector "eliminates" certain metals, we refer to this as the detector "discriminating" among different types of metals.

Discrimination is an important feature of professional metal detectors. Discrimination allows the user to ignore trash and otherwise undesirable objects.

PINPOINTING

Pinpointing is the process of finding the exact location of a buried object. Long-buried metals can appear exactly like the surrounding soil and can therefore be very hard to isolate from the soil.

GROUND CANCELATION

Ground Cancellation is the ability of the detector to ignore, or "see through," the earth's naturally occurring minerals, and only sound a tone when a metal object is detected. This detector incorporates proprietary circuitry to eliminate false signals from many mineralized soils.

CONTENTS OF BOX

The following detector components are in the box:



Headphone Jack Cover

1. Control Housing with 2 screws

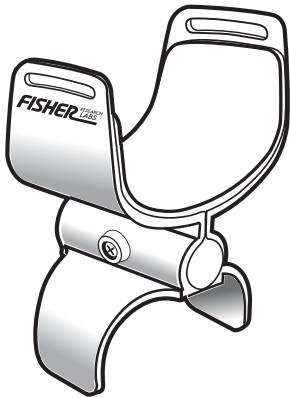

2. Armrest Assembly with Screw and Lock-Nut

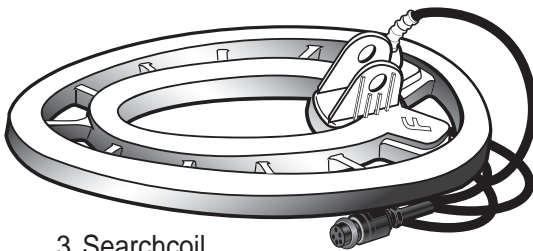

3. Searchcoil

O-Ring
One installed on coil connector and a replacement O-Ring included in manual bag.

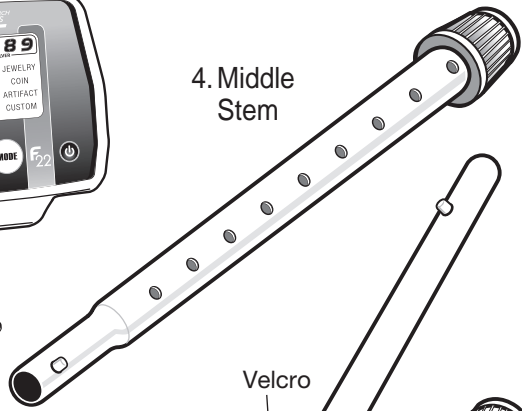

4. Middle Stem

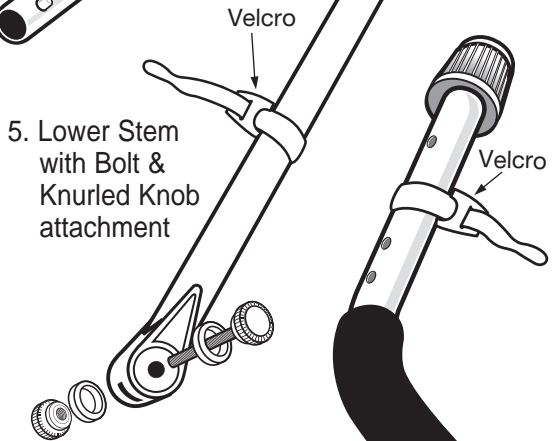

5. Lower Stem with Bolt & Knurled Knob attachment

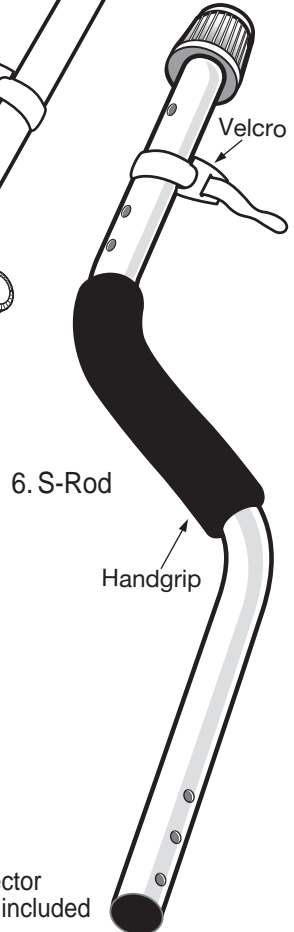

6. S-Rod

Handgrip

ASSEMBLY

Tool Required: #1 Phillips Screwdriver

- 1 • Remove the Screw from the Armrest.
 - Slide the Armrest over the end of the S-Rod.
 - Attach with Screw and Lock-Nut.
- 2 Attach Control Housing with Screws; install back screw first.

NOTE:

- The Handgrip fits under the Control Housing. Handgrip may partially cover one mounting hole. Peel back Handgrip to expose the front hole.
- Ensure the headphone jack cover is properly seated before attaching the control housing.

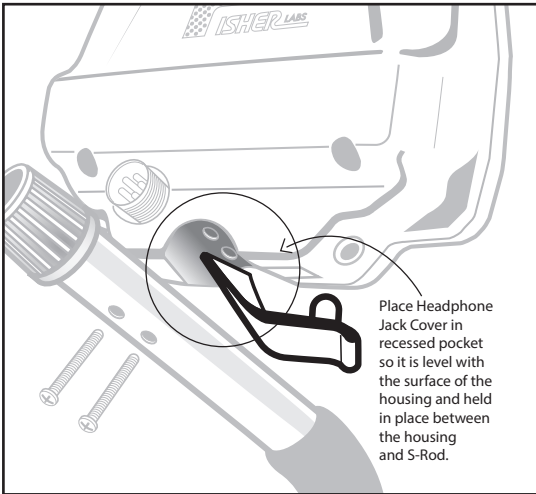
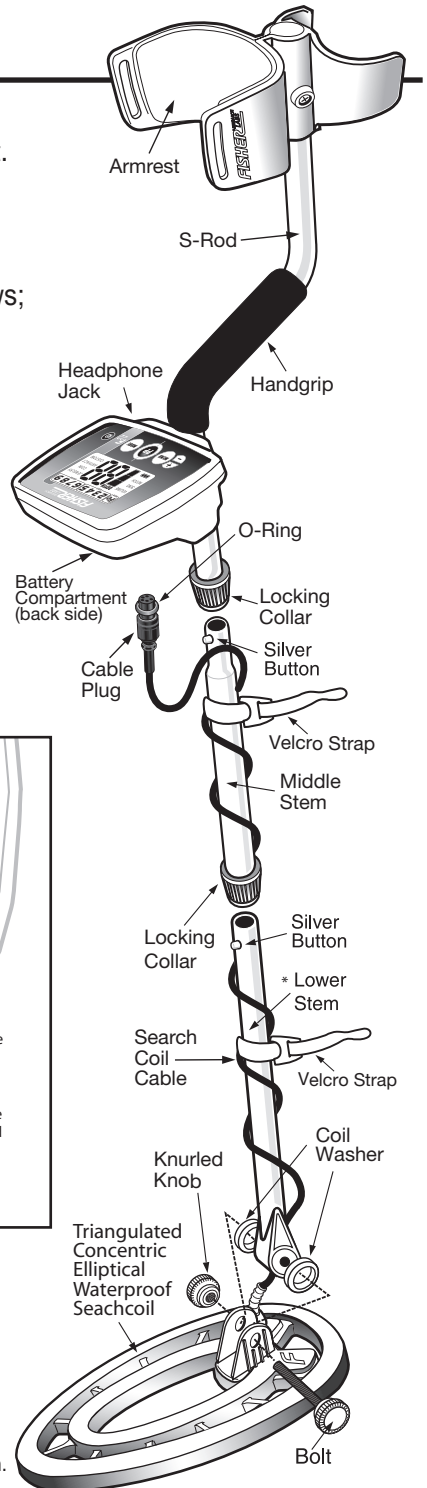

Caution:

Forcing in MIDDLE STEM with CAM LOCK raised may form a burr on cam lock. If this happens, remove burr with knife to allow insertion.

* Note: Very tall users can purchase the optional Extended Lower Stem (TUBE5X), for extended reach.

ASSEMBLY (Continued)

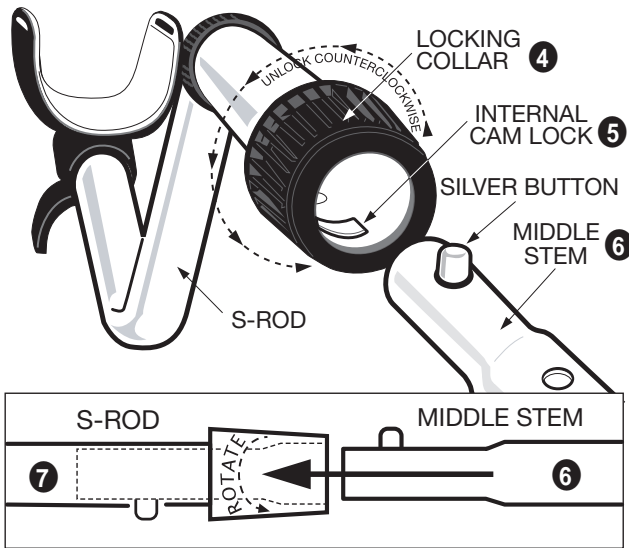

- 3 Position S-Rod upright.
- 4 Rotate the LOCKING COLLAR fully in the counterclockwise direction.
- 5 Insert your finger inside the tube and make sure the INTERNAL CAM LOCK is flush with the inside of the tube.
- 6 Insert the MIDDLE STEM into the S-ROD, with the SILVER BUTTON pointed upward.
- 7 Rotate the MIDDLE STEM until the SILVER BUTTON locates in the hole.
- 8 Twist the LOCKING COLLAR fully in the clockwise direction until it locks.
- 9 Repeat this process on the LOWER STEM.
- 10 Using the BOLT and KNURLED KNOB, attach the SEARCHCOIL to the LOWER STEM.
- 11 Adjust the LOWER STEM to a length that lets you maintain a comfortable upright posture with your arm relaxed at your side, and the SEARCHCOIL parallel to the ground in front of you.
- 12 Wind the CABLE securely around the STEMS, leaving slack at the bottom.
- 13 Connect CABLE PLUG to housing.
Do not twist the Cable or Plug. Turn Locking Ring only. Use minimal finger pressure to start the threads. Do not cross-thread. When the Locking Ring is fully engaged over the threaded connector, give it a firm turn to make sure it is very tight. When the Locking Ring is fully engaged over the threaded connector, it may not cover all of the threads.

BATTERIES

The detector requires two AA batteries. We recommend ALKALINE batteries (not included).

Do not use ordinary “Zinc Carbon” batteries.

Do not use “Heavy Duty” batteries.

Rechargeable batteries can also be used. If you use rechargeables, we recommend using a “Nickel Metal Hydride” rechargeable battery. The battery compartment is located on the right side of the Control Housing. Both batteries should be installed with the negative terminal down.

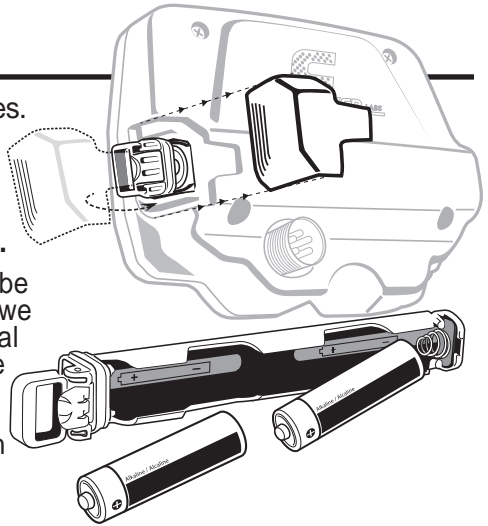

Remove battery tube:

1. Slide the battery door off.
2. Extend the handle on the battery tube (*with your finger or by using the tab on the battery door to pry the handle into the extended position*)
3. Pull on the handle to remove (*do not use the battery door tab to pull the tube out of the control housing, as this may cause damage to the battery door*)

To install battery tube:







1. Position the handle on the battery tube in the lowered position.
2. Firmly push down on the battery tube, until the battery tube handle is flushed with the housing. (*The battery tube will only insert one way, with the brass contacts facing towards the display and the hinged side of the handle towards the back.*)

BATTERY LIFE

Expect 25 to 30 hours of life from 2 AA Alkaline batteries. Rechargeable batteries provide about 15 hours of usage per charge. Backlight increases power consumption and decreases battery life, with significant power drain at maximum brightness.

BATTERY INDICATOR

The battery icon has three segments plus an outline segment. The amount of battery voltage for two ALKALINE batteries is indicated as follows:

-  All segments black: >2.8 volts
-  Right segment grey, other two black: >2.6 volts
-  Right segment off, other two black: >2.4 volts
-  Right segment off, mid grey, left black: >2.2 volts
-  Right and mid segments off, left black: >2.0 volts
-  Right and mid segments off, left grey: >1.8 volts
-  All segments off, outline flashing: < 1.8 volts

It is recommended to change the batteries when you see the one black segment.

SPEAKER VOLUME AND BATTERY CHARGE

You may notice the speaker volume drop while one battery segment is illuminated. With the outline flashing, low speaker volume will be very apparent.

BATTERY DISPOSAL & RECYCLING



Alkaline batteries may be disposed of in a normal waste receptacle or recycled. Other battery chemistries should be recycled.

QUICK-START DEMONSTRATION

I. Supplies Needed

- Nail (made of iron) • U.S. Quarter (or silver coin) • U.S. Nickel
 - Gold Ring • U.S. Dime • U.S. Penny, dated after 1982 (post-1982 pennies are made of Zinc)
- (Most newer non-U.S. coinage also contains mostly Zinc)

II. Position the Detector

- Place the detector on a table with the searchcoil hanging over the edge (or, have a friend hold the detector with the searchcoil off the ground).
- Keep the searchcoil away from walls, floors and metal objects.
- Remove watches, rings and jewelry.
- Turn off lights or appliances whose electromagnetic emissions may cause interference.
- Pivot the searchcoil back.
- Press  to power on. A series of 10 numbers will sequence across the screen, this is the serial number.
- Press  twice. All target categories are now illuminated.

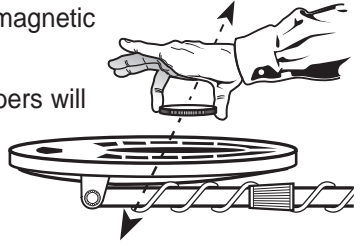

III. Demonstrate Modes:

- Press **MODE** button twice, display indicates Artifact Mode.
- Pass all objects over the searchcoil and notice the different tones. Notice the target icon indicators and the large two digit Target-ID number displayed for each item.

Nail: low tone

Nickel: medium tone



Zinc Penny: medium tone

Gold Ring: most gold rings will register with a medium tone

Dime: high tone

Quarter: high tone

IV. Demonstrate NOTCH Feature:

- Press  until "NOTCH" is illuminated.
- Press  until target icon "3" is flashing, then wait until icon stops flashing (*approximately 5 seconds*). The icon will be blanked out.
- Pass the Nickel over the searchcoil. It will not be detected. The Nickel has been "notched" out.
- Press  4 times, target icon 3 is now flashing, then wait until icon stops flashing (*approximately 5 seconds*). The icon will now be notched back in. Only one target category can be notched at a time. Repeat the process to notch additional categories

V. Demonstrate DEPTH Indicator:

- Pass the Nickel close to the searchcoil (about 1" away).
- Notice the depth bar graph indicating a shallow target.
- Wave the Nickel farther away from the searchcoil and notice additional bar graph segments illuminating, indicating a deeper target.

VI. Demonstrate PINPOINT feature:

- Press and hold . "PP" momentarily appears on the screen.
- Hold a coin motionless over the searchcoil.
- Lower coin toward searchcoil and then raise coin away from searchcoil.
- Notice the sound changes as the coin distance varies.
- Notice the depth indicator changes as the coin moves up and down.

THE BASICS OF METAL DETECTING

This metal detector is intended for locating buried metal objects. When searching for metals, underground or on the surface, you have the following challenges and objectives:

1. Ignoring signals caused by ground minerals.
2. Ignoring signals caused by metal objects that you do not want to find, like nails.
3. Identifying a buried metal object before you dig it up.
4. Estimating the size and depth of objects, to facilitate digging them up.
5. Eliminating the effects of electromagnetic interference from other electronic devices.

Your metal detector is designed with these things in mind.

1. Ground Minerals

All soils contain minerals. Signals from ground minerals can interfere with the signals from metal objects you want to find. All soils differ and can differ greatly in the type and amount of ground minerals present. This detector has proprietary circuitry to automatically eliminate interfering signals from minerals that occur naturally in the ground.

NOTE: *This detector will not completely eliminate interference from all types of minerals. For example, the detector IS NOT designed for use on wet sand saltwater beaches. Another example of soil this detector will not eliminate is any soil containing large concentrations of iron oxides, which are usually red in color.*

2. Trash

If searching for coins, you want to ignore items like aluminum foil and nails. You can see the Target-ID of the buried objects, listen to the sounds and then decide what you want to dig up. Or, you can eliminate unwanted metals from detection by using the different Modes or NOTCH feature or use the Custom mode to create your own discrimination settings.

3. Identifying Buried Objects

Metal objects are identified along the 9-segment Conductivity graphic symbols and with a large 2-digit target ID number in the center of the screen. Both are indicators of the relative electrical conductivity of different objects. Segments to the right indicate more conductive targets. Iron objects will be illuminated with the Fe symbol. The Fe (iron) category will display target ID numbers from 1 to 19.

Gold, nickel and brass objects will be illuminated in the

“Gold” group .

Silver and copper objects will be illuminated in the

“Silver” group .

4. Size and Depth of Buried Objects

The 3-segment graphic indicates the relative depth of a buried metal object. This graphic can indicate the relative size of different objects or their distance from the searchcoil. For a given object, the more distance between it and the searchcoil, the more segment lines illuminated.

THE BASICS OF METAL DETECTING

5. EMI (Electromagnetic Interference)

The searchcoil produces a magnetic field and then detects changes in that magnetic field caused by the presence of metal objects. This magnetic field the detector creates is also susceptible to the electromagnetic energy produced by other electronic devices. Electric fences, cell phones, cell phone towers, power lines, microwave ovens, lighting fixtures, TVs, computers, motors, etc., all produce EMI which can interfere with the detector and cause it to beep erratically.

The SENSITIVITY control lets you reduce the strength of this magnetic field and therefore lessen its susceptibility to EMI. You may want to operate at maximum strength, but the presence of EMI may make this impossible, so if you experience erratic behavior or “false” signals, **reduce the sensitivity.**

USING THE DETECTOR

Sweep Method

Sweep the detector side-to-side over the ground.

Keep the searchcoil parallel to the ground as you sweep; do not lift the searchcoil at the ends of your sweeps.

Searchcoil motion is required for target detection.

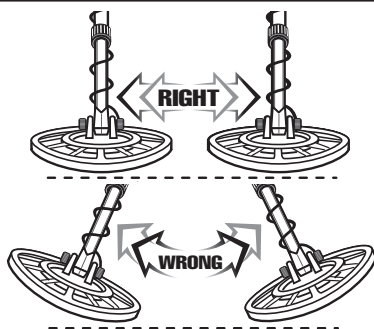

9" WATERPROOF SEARCHCOIL

This detector is equipped with an 9" triangulated elliptical concentric waterproof searchcoil. This lightweight, ruggedly constructed searchcoil can be fully submerged into water. The bottom portion of the pole assembly can also be submerged, but the control housing and the searchcoil cable plug connection into the housing must not be submerged. The weatherproofing on the F22 was designed to allow hunting in inclement weather but it was not designed to withstand submersion in water.

A smaller searchcoil offers more precision and fits into tight spaces. Larger searchcoils provide for more ground coverage on each sweep and penetrate deeper into the ground. Biaxial searchcoils provide better penetration in mineralized soils.

OPERATION and CONTROLS

HOW TO WORK THE CONTROLS

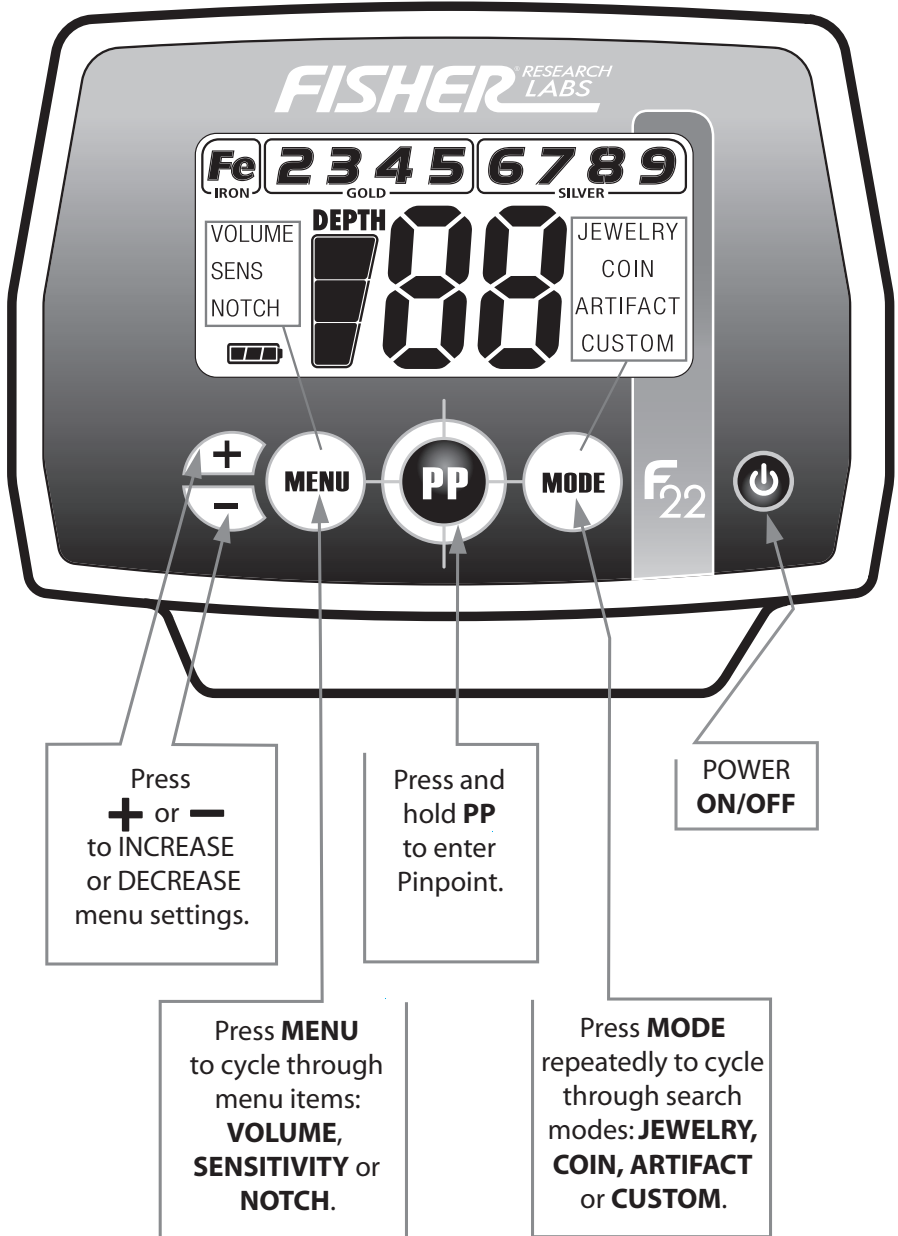

THE DISPLAY

Target Category Icons

Icons will turn from outlined to solid indicating a detected target. A "blank" position indicates a Notched-out target category.

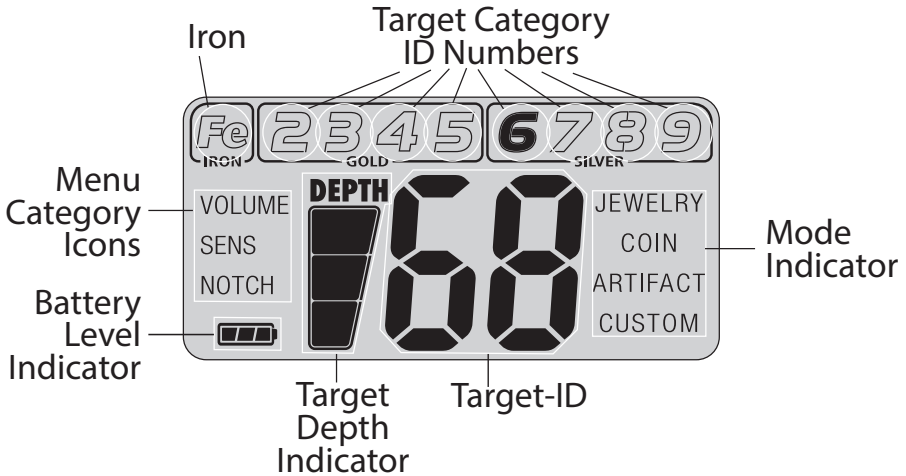

DEPTH INDICATOR

Coin-sized objects will be detected up to 9" deep. The 3-segment graphic indicator is calibrated to coin-sized objects.

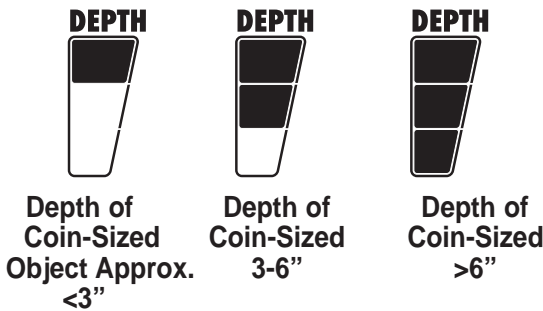





Objects other than coins will still register on the 3-segment depth scale, but the depth indication will be relative. For example, all 3 segments illuminated could indicate a coin buried 9" deep, but could also be a very large object several feet deep. Use the Depth Indicator in conjunction with the Target Category Icons to gain more information.

OVERLOAD WARNING

If a metal object or highly magnetic soil is too close to the searchcoil, the detector will *overload* and a "--" will appear on the screen. The detector will make a rapid, repeating mid-tone warning sound. *Overload* will not harm the detector, but the detector will not function under these conditions. If *overload* occurs, raise the searchcoil to detect the target from a greater distance, or move to a different location.

MENU

The Menu items are located on the left side of the screen. During normal operation the Menu is inactive and the text icons are faded. Press  to cycle through the Menu. Each press of  moves to the next Menu item and when active the icon will be bold.

Use ( ) within each menu item to make adjustments. Menu options:

VOLUME

Adjust speaker volume from 0 to 20. The default setting is 7. With a setting of “0”, the detector will function as normal but it will not emit any sound when targets are detected.

The F22 has FeTone™, adjustable Iron audio, a feature to reduce the volume of iron targets to minimize user fatigue.

Volume settings of 10 – 20 are available to control the volume level of the iron targets. As you increase volume from 10 to 20, iron-volume changes from silent to maximum. At each of the 10 – 20 volume settings, nonferrous target response remains at maximum volume. At volume setting 0 – 9 both ferrous and nonferrous targets have equal volume.

Example: at volume setting 15, nonferrous target volume is maximum, ferrous target volume is at “5”, or half volume.

Table describes ferrous and nonferrous volume at each setting

| Setting | Volume | |
|---------|------------|---------|
| | Nonferrous | Ferrous |
| 1 | 1 | 1 |
| 2 | 2 | 2 |
| 3 | 3 | 3 |
| 4 | 4 | 4 |
| 5 | 5 | 5 |
| 6 | 6 | 6 |
| 7 | 7 | 7 |
| 8 | 8 | 8 |
| 9 | 9 | 9 |
| 10 | 10 | 0 |

| Setting | Volume | |
|---------|------------|---------|
| | Nonferrous | Ferrous |
| 11 | 10 | 1 |
| 12 | 10 | 2 |
| 13 | 10 | 3 |
| 14 | 10 | 4 |
| 15 | 10 | 5 |
| 16 | 10 | 6 |
| 17 | 10 | 7 |
| 18 | 10 | 8 |
| 19 | 10 | 9 |
| 20 | 10 | 10 |

SENS

Adjust the sensitivity from 1 to 10, the default is 6. The higher the number, the more sensitive the detector.

If the detector beeps erratically or beeps when there are no metal objects being detected, **reduce the sensitivity.**

The searchcoil produces a magnetic field and then detects changes in that magnetic field caused by the presence of metal objects. This magnetic field the detector creates is also susceptible to electromagnetic energy (EMI) produced by other electronic devices. Cell phones, cell phone towers, etc., all produce EMI which can interfere with the detector and cause it to beep when no metal is present, and sometimes to beep erratically.

MENU (Continued)

NOTCH

The Notch control allows you to accept or reject different types of metals per each target category group. All categories are eligible for NOTCH. Each mode: Jewelry, Coin, Artifact and Custom has its own set of notches.

With Notch menu active, press “+” or “-“ to program the Notch feature. Each press of the “+” or “-“ cycles to a new category and the active position is indicated by a flashing icon. Select desired category and wait 5 seconds or press the menu button for immediate notch setting. That category will reverse status. If the icon had previously been illuminated it will now disappear indicating the category has been eliminated from detection. Likewise, an icon that is not visible on the display will re-illuminate, indicating that category is now notched in and targets will be detected.

All of the 9 target categories can be notched, but only one category can be notched at a time. All Notch settings are saved when the detector is turned off.

MODES

There are four different preset modes: Jewelry, Coin, Artifact and Custom. Each of these modes have specific audio tones, see the section labeled **4-Tone Target Identification** for specific details. The active mode indicator is displayed on the right side of the screen.

Jewelry Mode: Fe (Iron) category notched out.

Coin Mode: Fe (Iron) and Target Category groups 2 (Foil) and 4 (Aluminum) notched out.

Artifact Mode: All Target Categories enabled.

Custom Mode: User definable.







Each of the four Modes can be changed by notching target category groups in or out. Settings are saved at power down. To reset your F22 to the preset factory settings:

1. Turn the detector off.
2. Hold the MENU button down while pressing the Power button.

NOTE: This reset will erase any custom tone settings you may have entered in the Custom Mode.

CUSTOM MODE PROGRAMMABLE TONES

To program your Custom mode tones:

1. Press  button until CUSTOM is activated.
2. Press and hold  for approximately 1 second.
3. Press  button to cycle through target categories.
4. To select a tone for the desired category, press “+” or “-“ to cycle through 5 tone options (0=VCO, 1=bass, 2=low, 3=medium, 4=high).
5. To exit the tone selection mode, press .
6. To continue setting tones for additional categories Press  to select and cycle to next target category. To exit the tone selection mode, press .

MENU (Continued)

PINPOINT

Press and hold  to activate. Searchcoil motion is not required; a motionless searchcoil over a metal target will induce sound. The screen will blank except for the 2-digit number display indicating target depth in inches. The scale is calibrated to coin-sized objects. The depth indication will vary as you scan your target. The target center is where the smallest depth indication displays.

Tone and pitch of the audio will vary as the coil passes over the target. This audio can yield more information about the target's shape and size and also find its exact location to facilitate extraction. The target center is where the loudest and highest pitch is indicated.

HOW TO PINPOINT

After you have identified a target, move the coil to one side of the target, be sure you are not over any metal, then press-and-hold the pinpoint button and rescan the target.

Pinpoint as follows:

1. Press and hold .
2. Position the searchcoil just barely off the ground and to the side of the target.
3. Now move the searchcoil slowly across the target.

The target is located directly under where the sound is loudest and the depth indication is smallest.

Narrow It Down:

1. For large targets you can narrow the response further by positioning the center of the searchcoil near the center of the response pattern, but not directly over the center.
2. Release Pinpoint.
3. Immediately press-and-hold again.
4. Repeat this narrowing procedure to narrow the field of detection further.

Note: Depth indication is less accurate after narrowing.

COIL DRIFT

If you plan to use PINPOINT for continuous searching, realize that drift will occur over time, causing the detector to gain or lose sensitivity. Periodic retuning of the detector is required to minimize drift; release and press periodically to retune.

PINPOINTING USING MOTION MODES (without using)

1. Sweep over target in narrowing side-to-side patterns.
2. Visualize a "center line" on the ground where "beep" occurs.
3. Rotate 90° and now sweep along this imaginary line.
4. Visualize a second "center line" on the ground where "beep" occurs.
5. The "X" center pinpoints the target location.

TARGET IDENTIFICATION

Target-ID

When metal objects are detected, the detector will emit a sound, a Target-ID Category icon will illuminate and a 2-digit Target-ID number will appear on the screen. Possible Target-ID numbers range from 1 to 99. This number represents the electrical conductivity of the target; higher numbers indicate more highly conductive targets.

Target indicators on the screen only represent the last object detected. This detector has fast target response and is able to detect different objects in very close proximity. Therefore, the Target-ID displayed may change rapidly as you sweep the searchcoil.

Three seconds after a target is detected, the ID numbers will time-out and disappear and the Target Category Icon will change to the non-illuminated state.

Iron, Gold and Silver Indicators:

The group border momentarily flashes when an object in that group is present.



The border flashes independently of the notch settings.

Relic hunters will frequently seek out iron-laden sites as good prospective treasure-hunting sites. The iron indicator alerts the user to the presence of iron, even if iron has been discriminated out. Relic hunters can search free of iron-target audio, yet still be alerted to the presence of ferrous objects or search with no discrimination and use the FeTone™ feature to decrease the Audio Volume of ferrous targets.

4-Tone Target Identification

The detector will provide 1 of 4 sounds for any metal object detected: a bass, low, medium or high tone. This audio feedback system is useful in conjunction with the visual Category Icon system described above.

Target Conductivity Bar

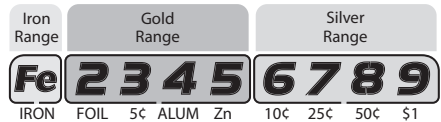

| | Iron | | Gold | | | Silver | | | |
|-----------------|----------------------------|------|--------|------|-----|--------|-----|------|--------|
| | Fe | 2 | 3 | 4 | 5 | 6 | 7 | 8 | 9 |
| | Iron | Foil | Nickel | Alum | Zn | Dime | Qtr | Half | Dollar |
| Jewelry | Bass | Med | Med | Med | Med | Hi | Hi | Hi | Hi |
| Coin | Bass | Bass | Med | Bass | Low | Hi | Hi | Hi | Hi |
| Artifact | Bass | Med | Med | Med | Med | Hi | Hi | Hi | Hi |
| Custom | User definable default VCO | | | | | | | | |

Ferrous, gold and silver targets will generally register within their corresponding category icon ranges. Targets that are not gold or silver register within the same range according to their electrical conductivity. Note that the electrical conductivity of a target depends on both its composition and size. Silver is more conductive than gold so it registers farther to the right; and the larger the silver object, the farther it registers to the right. There are a wide variety of metals and no target can be identified for certain until unearthed. See coin reference table on page 17.

TARGET IDENTIFICATION (Continued)

Jewelry, Coin and Artifact modes have predefined audio tones for the various Target Category groupings. The Custom mode is programmable and users can assign any tone to any of the Target Category groups. The Custom modes default tone for all categories is a single proportional tone (V.C.O.). V.C.O. varies in pitch and volume depending on the depth and size of the target. The custom tones are automatically saved when the unit is turned off.

Target-ID Coin Reference *Below are known Target-IDs for some reference coins:*

| | | | |
|---|-------|---|-------|
| Merovingian Triens (gold, France) | 21 | 1 Euro Coin | 48-56 |
| Celtic Potin (copper+lead) | 27 | Medieval double sol coin (France) | 50 |
| Russian Scale Peter I, 1705, Silver, 0.25 gr. | 34-36 | British £1 | 57-62 |
| US Nickel | 34-36 | US Dime | 64-66 |
| Roman Nummus (bronze) | 40 | Polish Zloty (Pre-WWII) 2zl (1933 silver) | 75-76 |
| 2 Euro Coin | 43-47 | US Quarter | 74-77 |
| British 20p | 45-46 | US Silver Dollar | 90-92 |
| USSR, 5 kopeek, 1961, Bronze, D 25 mm. | 46 | Russian, 1 ruble Nikolay II, 1896, Silver, D 34 mm. | 97-98 |
| Bulgarian 1 lev | 47-49 | | |

DEPTH & TARGET DISPLAY

READING THE DISPLAY

The display shows the PROBABLE identification of the metal detected, as well as its PROBABLE depth.

The detector will register a target upon each sweep of the searchcoil, when a buried target has been located and identified. If, upon repeated passes over the same spot the target identification reads inconsistently, the target is probably a trash item. With practice, you will learn to unearth only the repeatable signals.

Target-ID numbers, as indicated on the Coin Reference chart (page 17), are highly accurate when those items are detected. However, there are many other metallic items that will register within these groups, so identification is not always accurate. Multiple targets in close proximity to each other, especially if one is above the other in the soil matrix, can display non typical ID and Depth, or “mask” out the deeper target altogether. The greater the distance between the target and the searchcoil, the less accurate the target identification.

Depth indication in the Pinpoint mode is accurate on coin-sized objects as defined in the category groups, but it too can be inaccurate if multiple targets of varying depth and conductivities are in close proximity of each other.

GOLD TARGETS Gold objects will generally register in the “GOLD” group with smaller items in groups 2 & 3 and larger items in groups 4 & 5. **Gold flakes** will register under iron.

SILVER TARGETS: Silver objects will register in the “Silver” group, A U.S. dime will ID in group 6, a US quarter in group 7, a U.S. half dollar in group 8 and a U.S. dollar in group 9.



Fe 1-19. All sizes of iron objects will register on the far-left side of the scale. This could indicate a worthless item such as a nail, or a more valuable historic iron relic.

2 20-29. Aluminum foil, such as a gum wrapper, will register as foil. A small broken piece of pull tab may also register here.

3 30-39. **U.S. Nickels**, most newer pull-tabs from beverage cans, the type intended to stay attached to the can, will register here. Many gold rings will also register here.

4 40-49. Many medium-sized gold rings also register here. A few newer pull-tabs will also register here. Many gold rings will also register here. **S-CAP:** Older screw caps from glass bottles will register here. Large gold rings, like a class ring, could also register here. Some non-U.S. coins of recent vintage will also register here.



DEPTH & TARGET DISPLAY *(Continued)*

5 **50-59. US. Zinc coins** and many non-U.S. coins of recent vintage are classified here.

6 **60-69.** Copper coins, small silver coins (U.S. dime)

7 **70-79.** Medium sized silver coins (U.S. quarters)

8 **80-89.** Large silver coins (U.S. half dollars).

9 **90-99.** Very Large silver coins (U.S. silver dollar). When used in

areas outside the U.S., these categories identify coins or metal objects of high relative conductivity (such as silver coins or relics), or large objects made of any type of metal.

Caution: The target indications are visual references. Many other types of metal can fall under any one of these categories. While the detector will eliminate or indicate the presence of most common trash items, it is impossible to accurately classify ALL buried objects.

**See Target-ID
Coin Reference Chart (Page 18).**

HEADPHONE JACK

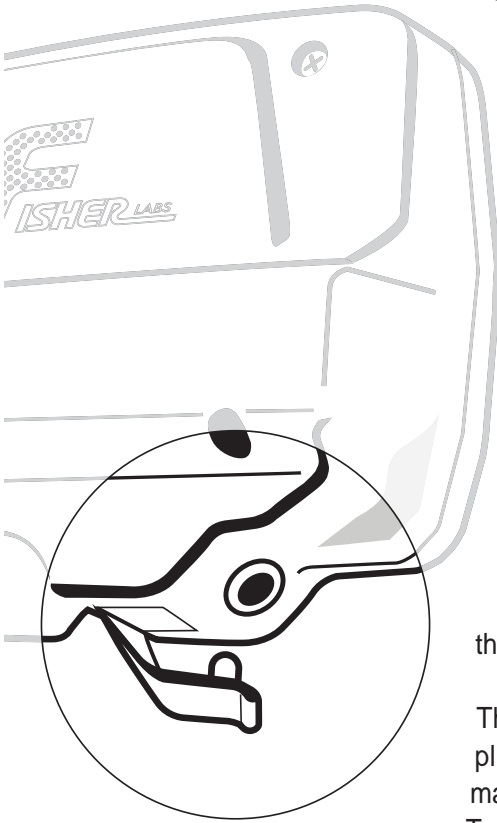

This detector has a 1/4" headphone jack. It works with any stereo headphone that has a 1/4" plug. When the headphone jack is connected, speaker volume is disabled. Using headphones extends battery life and prevents the sounds from bothering bystanders. Headphone use also facilitates detection of the weakest signals.

For safety reasons, do not use headphones near traffic or where other dangers are present. This device is to be used with interconnecting cables shorter than three meters.

The headphone jack has a rubber plug that will help keep foreign material from entering the control box. To insure it remains weatherproof, do not use headphones during rain or very wet conditions.

CHARACTERISTICS & LIMITATIONS

1. This detector comes with a waterproof searchcoil. The searchcoil can be completely submerged into water. The **control housing is weatherproof but cannot be submerged in water.**
2. BURIED UTILITY LINES. This hobby metal detector is not designed to locate buried pipes or cables. First Texas Products manufactures a complete line of pipe and cable locators for this application. These are sophisticated instruments with functionality different from your hobby metal detector.
3. SEVERE SOIL CONDITIONS. While this detector has proprietary circuitry to cancel out minerals naturally occurring in most soil types, **it cannot penetrate the most severe soils and it is not intended for use on wet sand saltwater beaches.** However, it is well-suited for detecting on dry sand. Saltwater is highly conductive and requires a more sophisticated type of detector. First Texas Products offers such types of detectors. Other highly mineralized soils, such as those found in some gold prospecting sites, may also limit this detector's capability. If the detector tends to overload it could indicate you are in an area containing such severe soils.
4. TARGET-ID. The detector's Target-ID system calculates and displays the most probably identification. Target-ID is affected by soil conditions, the searchcoil's distance from the target, the length of time the target has been buried and the target's proximity to other dissimilar targets. Very large metal objects can overload the detector and may be classified inaccurately.
5. REDUCE SENSITIVITY. The primary purpose of the Sensitivity control is to allow the operator to **reduce the sensitivity** of the detector. All detectorists desire to find objects at maximum depth. However, in today's environment there is a never-ending variety of devices emitting EMI (Electromagnetic Interference) that can interfere with this detector.

There will be environments where the detector cannot operate at maximum sensitivity. This is not a defect. If you find yourself in such an environment, reduce the sensitivity of the detector. Some environments may have so much EMI it is impossible to detect there. Both overhead power lines and buried power lines can interfere with this detector. Power line capacity may be quite different during certain times of the day. For instance, peak hours of electrical use that can occur around 6 p.m. can lead to a lot of EMI. If you experience power line interference, try returning to a given area at a different time of day.

TROUBLESHOOTING GUIDE

| SYMPTOM | CAUSE | SOLUTION |
|--|---|--|
| Detector chatters, beeps erratically or has low sensitivity | <ul style="list-style-type: none"> • Using detector indoors • Using detector near power lines • Using 2 detectors in close proximity • Environmental electromagnetic interference | <ul style="list-style-type: none"> • Use detector outdoors only • Move away from power lines • Keep 2 detectors at least 6 meters (20') apart • Reduce sensitivity until erratic signals cease |
| <p>Do not mix old and new batteries. Use alkaline batteries. Do not mix alkaline, standard (zinc-carbon), or rechargeable (NiCad, NiMH, etc.) batteries.</p> | | |
| Low speaker volume | <ul style="list-style-type: none"> • Discharged battery • Wrong type of battery | <ul style="list-style-type: none"> • Replace battery • Use alkaline batteries |
| Display does not lock on to one Target-ID or detector emits multiple tones | <ul style="list-style-type: none"> • Multiple targets present • Highly mineralized soil • Sensitivity set too high | <ul style="list-style-type: none"> • Sweep coil at different angles • Move to a different area • Reduce sensitivity |
| No power, no sounds | <ul style="list-style-type: none"> • Dead battery • Cable not connected securely | <ul style="list-style-type: none"> • Replace batteries • Check connections |

Note: This equipment has been tested and found to comply with the limits for a Class B digital device, pursuant to part 15 of the FCC Rules. These limits are designed to provide reasonable protection against harmful interference in a residential installation. This equipment generates, uses and can radiate radio frequency energy and, if not installed and used in accordance with the instructions, may cause harmful interference to radio communications. However, there is no guarantee that interference will not occur in a particular installation. If this equipment does cause harmful interference to radio or television reception, which can be determined by turning the equipment off and on, the user is encouraged to try to correct the interference by one or more of the following measures:

- Reorient or relocate the receiving antenna.
- Increase the separation between the equipment and receiver.
- Consult the dealer or an experienced radio/TV technician for help.

CE The manufacturer declares that the minimum ESD performance criteria is 1) the unit shall not be permanently damaged and 2) operator intervention is allowed.

This product is RoHS compliant.

This product meets the requirements of Industry Canada: CAN ICES-3 B/NMB-3 B.

TREASURE HUNTER'S CODE OF ETHICS:

- Always check Federal, State, County and local laws before searching.
- Respect private property and do not enter private property without the owner's permission.
- Take care to refill all holes and leave no damage.
- Remove and dispose of any and all trash and litter found.
- Appreciate and protect our inheritance of natural resources, wildlife and private property.
- Act as an ambassador for all treasure hunters; use thoughtfulness, consideration and courtesy at all times.
- Never destroy historical or archaeological treasures.
- All treasure hunters may be judged by the example you set; always conduct yourself with courtesy and consideration of others.

ACCESSORIES

Fisher® Padded Carry Bag

Rugged double stitched construction. Includes handy exterior pocket for extra batteries or small accessories.

– 103693000C

Fisher® Camo Pouch

Camo pouch with two inside pockets, belt included. – PCH-F

Stereo Headphones

Use with Fisher® metal detectors. Lightweight and adjustable with true stereo sound, adjustable volume, 1/4 jack with 1/8 adaptor, 4' cable. – 9720950000

Metal Sand Scoop

Large galvanized metal scoop with filtering holes. Strong Rubberized grip.

– SAND SCOOP

Lesche Knife

Made from high quality heat-treated tempered steel. The ultimate digging tool. Comes with a durable sheath. 12" in length with a 7" serrated blade.

– LESCHE KNIFE

Fisher® Baseball Cap

One size fits all. – FCAP

Fisher® T-Shirt

100% cotton with Fisher® Logo. Sizes: S, M, LG, XL & XXL – FTSHIRT

Replacement/Accessory Search Coils

7" Round Elliptical Accessory Coil – 7COIL-RE-F

9" Triangulated Concentric Elliptical Replacement Coil – 9COIL-EE

11" Triangulated Concentric Elliptical Accessory Coil – 11COIL-EE

Coil Covers

Specially made to protect your coil from abrasion and damage.

9" Triangulated Concentric Elliptical Coil Cover – 9COVER-EE

11" Triangulated Concentric Elliptical Coil Cover – 11COVER-EE

Rain Cover

Neoprene protective cover specially made to protect your F22 from weather – COV-F22

Gold Prospecting Kits

Items Included:

| | Gold Kit PART NUMBER: GOLDKIT1 | Deluxe Kit PART NUMBER: GOLDKIT2 | Hardrock Kit PART NUMBER: GOLDKIT3 |
|------------------------|---|---|---|
| 10 1/2" Gold Pan | x | x | x |
| 14" Gold Pan | x | x | x |
| Classifier | | x | x |
| 2 – Shatterproof Vials | x | x | x |
| Snuffer Bottle | x | x | x |
| Black Sand Magnet | | x | x |
| Treasure Scoop | | x | x |
| Tweezers | | | x |
| Magnifier | | | x |
| Crevice Tool | | | x |
| Rock Pick | | | x |
| Instruction Booklet | x | x | x |
| Backpack | | x | x |

