



ECLIPSE™

OWNER'S MANUAL

8'x8'
(2.5 m x 2.5 m)

10'x10'
(3.0 m x 3.0 m)

10'x15'
(3.0 m x 4.5 m)

10'x20'
(3.0 m x 6.0 m)

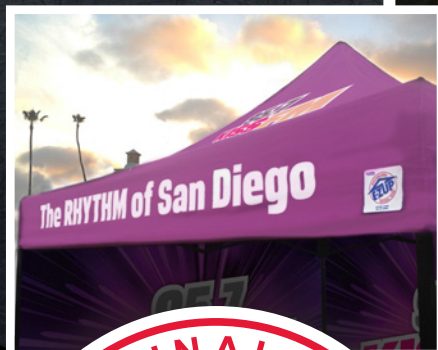

THANK YOU

Thank you for purchasing your E-Z UP[®] Instant Shelter[®].

With proper care, this Instant Shelter[®] will deliver years of trouble-free use. Please take a few minutes to read the use and care instructions in this manual.

TABLE OF CONTENTS

About Us.....	4
Important Information.....	5

8' x 8', 10' x 10' and 10' x 15' Models

(2.5 m x 2.5 m) (3.0 m x 3.0 m)

(3.0 m x 4.5 m)

Package Contents.....	6
Parts Diagram.....	7
One-Time Top Installation	8
Set Up	11

10' x 20' Model

(3.0 m x 6.0 m)

Package Contents.....	15
Parts Diagram.....	16
One-Time Top Installation	17
Set Up	22

All Models

Take Down.....	25
Care & Maintenance.....	28
Product Warranty.....	29

ABOUT US

THE ORIGINAL & STILL THE BEST

Over 30 years ago, Mark Carter, Founder & Chairman of International E-Z UP, Inc., created the first Instant Shelter®. Today, E-Z UP® Instant Shelters® are still the easiest to open, highest quality, and most durable instant shelter available.

INNOVATION...IT'S IN OUR DNA

Over 150 patents is a testament to our innovation. We are the brand leader in the portable shelter industry, and we maintain this position by continuously innovating our products and processes. We just can't help ourselves; it's in our DNA.

A TRADITION OF THE HIGHEST QUALITY

While our commitment to innovation drives us forward, it is our dedication to quality that defines us. From concept to development to finished product, E-Z UP meticulously designs, engineers and tests the smallest details of construction and material to ensure years of durable use. All of this is supported with extended warranties from a brand you can trust.

AWARD WINNING DESIGN & PRODUCTION

For multiple years, E-Z UP has won the Gold Award for Digital Printing by the Specialty Graphics Imaging Association. Consistently earning the highest honor for printing excellence from the graphics industry's leading authority designates E-Z UP as among the top specialty printers in the world. When you need the best Instant Shelter® with award winning digital printing, rely on the brand recognized by industry experts.

IMPORTANT INFORMATION

READ THIS INFORMATION BEFORE PROCEEDING. IT IS THE USER'S RESPONSIBILITY TO TAKE THE FOLLOWING PRECAUTIONS AT ALL TIMES.

Always stake or weigh down your E-Z UP® Instant Shelter® with genuine E-Z UP® accessories. Do not use in any potentially windy or rainy weather.

Wind and rain can damage the E-Z UP® Instant Shelter® product and may also result in injury to you or others. Therefore, do not rely on your Instant shelter® for protection in heavy or prolonged rain storms.

The E-Z UP® Instant Shelter® product is designed as a temporary shelter. Do not leave it up for extended periods.

Use caution when handling the E-Z UP® folding frame. Avoid pinching hands or fingers as frame opens or closes.

Do not use shelter in a lightning storm.

Do not leave your E-Z UP® Instant Shelter® product unattended.

Do not build fires within your E-Z UP® Instant Shelter® enclosure.

WARNING:

Keep all flame and heat sources away from all Instant Shelter® fabrics and accessories. These fabrics meet the flammability requirements of CPAI-84. The fabric may burn if left in continuous contact with any flame source. The application of any foreign substance to the fabric may render the flame-resistant properties ineffective.

PACKAGE CONTENTS

For 8' x 8', 10' x 10' and 10' x 15' Models
(2.5 m x 2.5 m) (3.0 m x 3.0 m) (3.0 m x 4.5 m)

Your shelter is packaged in two boxes:

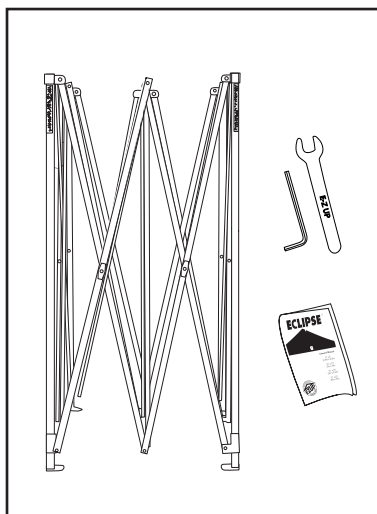

FRAME BOX CONTENTS:

Frame
Owner's Manual
Allen Wrench
7/16 Wrench

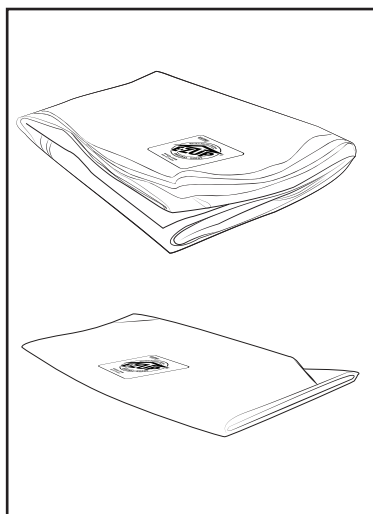

TOP BOX CONTENTS:

Fabric Top
Cover Bag

PARTS DIAGRAM

The parts noted below are referenced in **bold** in the Set Up and Take Down instructions in this manual. Refer to the diagram below for appropriate frame location.

Use this diagram for shelter sizes:

8' x 8' (2.5 m x 2.5 m) **10' x 10'** (3.0 m x 3.0 m) **10' x 15'** (3.0 m x 4.5 m)

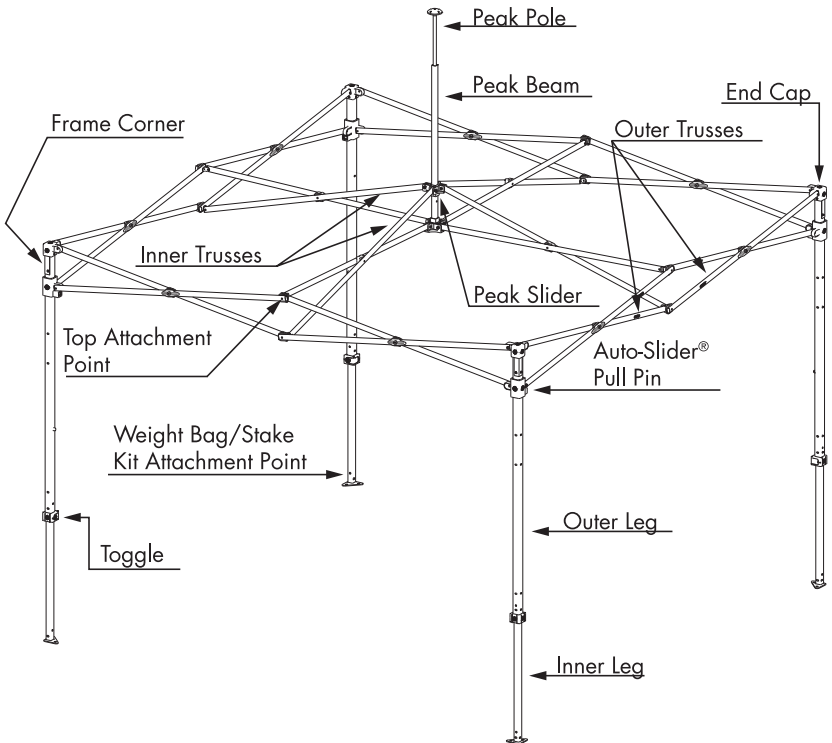

ONE-TIME TOP INSTALLATION

1 UNPACK AND OPEN

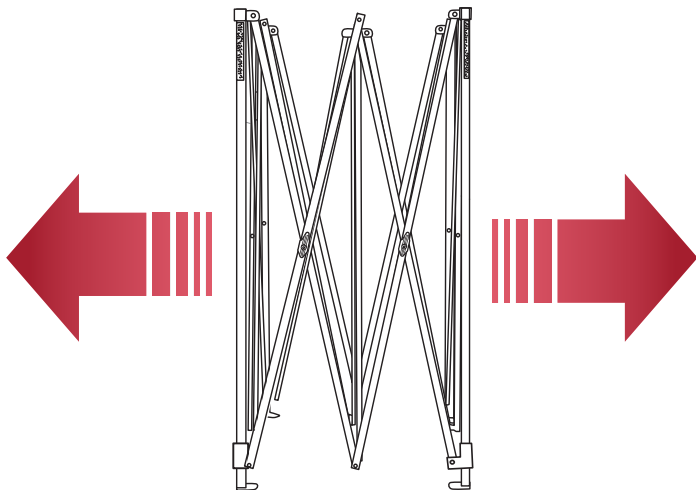

- A** Place your E-Z UP® frame in the center of the area to be sheltered.
- B** With partner on the opposite side of the frame, grasp two **outer legs**, lift the frame slightly off the ground, and step backwards while pulling the frame to open.
- C** Stop when the frame is approximately $3/4$ of its fully-opened size.
- D** Set the frame back on the ground.

ONE-TIME TOP INSTALLATION

2

ATTACH FABRIC TOP

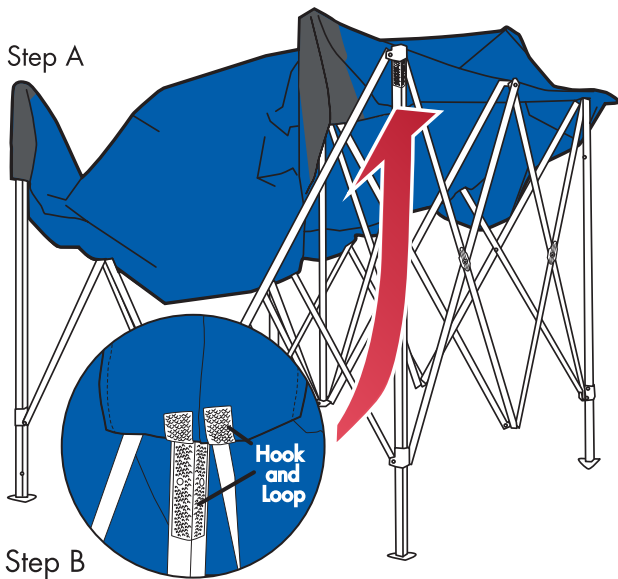

- A Gently unfold the fabric top, and place it over the semi-opened frame.
- B Attach the fabric top to the E-Z UP[®] frame by matching the hook and loop strips on the inside of the fabric top corners with the hook and loop strips on each **frame corner**.
- C Pull the fabric top down over the **frame corners**—pushing the hook and loop strips firmly together.

ONE-TIME TOP INSTALLATION

3 SECURE TOP TO FRAME

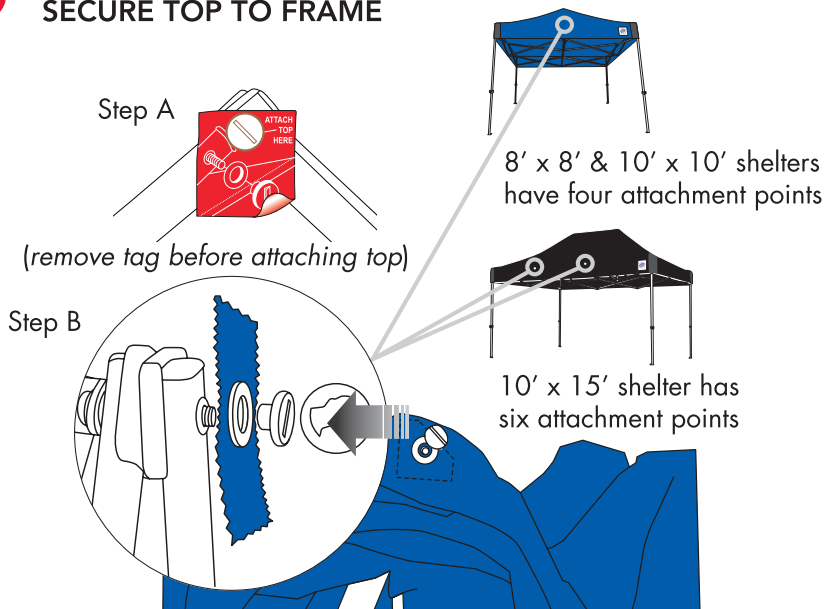

- A Line up the grommet holes on the sides of the fabric top to the frame **top attachment points**. The top attachment points on the frame are denoted by the “RED” tags.
- B Using a coin, unscrew the top attachment nut from the frame bolt.
- C Place fabric top grommet on the frame bolt.
- D Screw on top attachment nut and tighten until snug. Top fabric should rotate easily. Do **not** over-tighten.
- E Repeat this procedure at each of the **top attachment points**.

Note: Hold the bolt assembly with one hand while tightening the top attachment nut with your other hand.

SETUP

1

OPEN E-Z UP® SHELTER

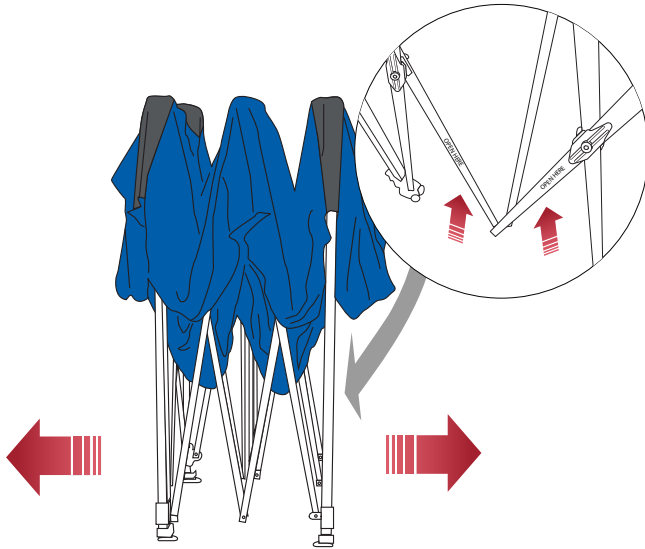

- A With a partner on the opposite side, grasp the bottom of the diamond-shaped area of **outer trusses** near the “OPEN HERE” sticker (see arrows for OUTER TRUSSES on the diagram on page 7 for approximate location of “OPEN HERE” stickers).
- B Lift the frame up slightly and step backwards until the shelter is almost fully opened. Gently shake the shelter while opening. *Be careful not to pinch fingers!*

FOR 10' x 15' (3.0 m x 4.5 m) MODEL ONLY:

Complete the above instructions on the 10' (3.0 m) side of the shelter.

SETUP

2 SECURE AUTO-SLIDER® PULL PIN

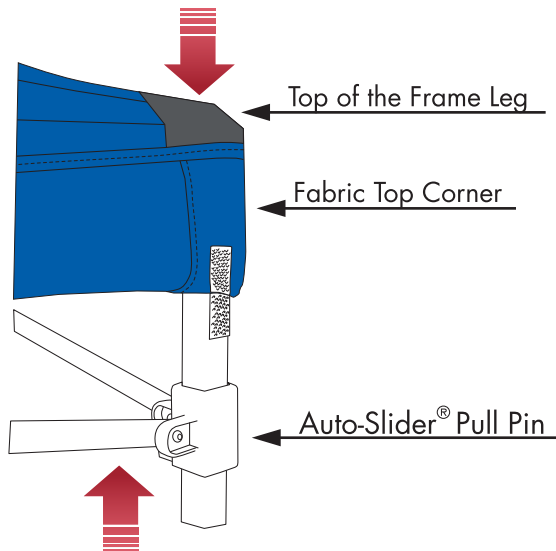

- A Fold up the fabric top corner to expose the **Auto-Slider® Pull Pin**.
- B Lift shelter corner slightly off the ground and engage the **Auto-Slider® Pull Pin** by pushing up on the frame side trusses with one hand while holding down the top of the frame leg with the other hand. The pins will auto-engage when aligned with the holes on the frame legs.
- C After the **Auto-Slider® Pull Pin** has locked into place, pull the fabric top down over the frame leg, making sure to align and secure the hook and loop strips on the fabric top to the frame.
- D Repeat on all remaining corners.

SETUP

3

EXTEND & SECURE FRAME LEGS

Leg Adjustment
Toggle Button

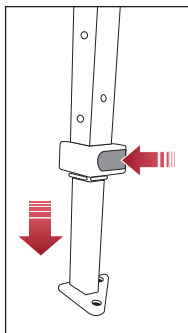

Stake Kit

Weight Bag

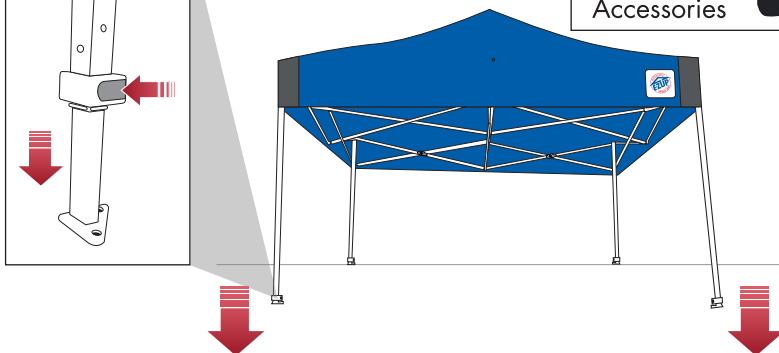

A Lift the two adjacent **outer legs** up off the ground simultaneously to about waist height.

B Slide the **lower/inner legs** out until the leg adjustment toggle buttons lock at selected height on each leg.

Note: There are 5 adjustment settings on each leg.

C Repeat on the remaining legs.

Note: It is recommended that you use genuine E-Z UP® deluxe weight bags and/or heavy-duty stake kits to secure your Instant Shelter®.

D **Your E-Z UP® shelter setup is now complete!**

For Take Down instructions, see page 25.

10' x 20' (3.0 m x 6.0 m) **MODEL**

ECLIPSETM

Professional



PACKAGE CONTENTS

For 10' x 20' Model

(3.0 m x 6.0 m)

Your shelter is packaged in three boxes:

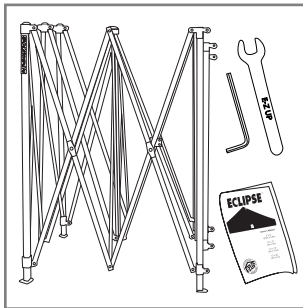

FRAME BOX A CONTENTS:

Frame A
Owner's Manual
Allen Wrench
7/16 Wrench

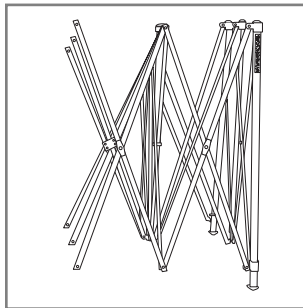

FRAME BOX B CONTENTS:

Frame B

TOP BOX CONTENTS:

Fabric Top
Cover Bag

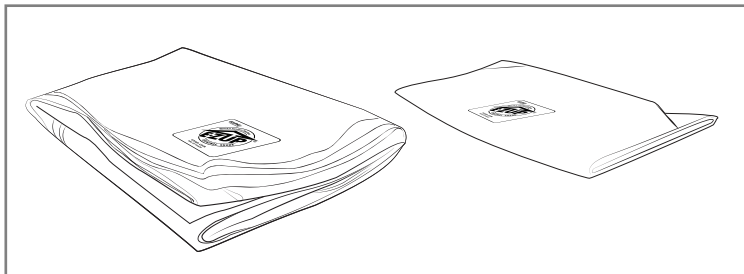

PARTS DIAGRAM

The parts noted below are referenced in **bold** in the Set Up and Take Down instructions in this manual. Refer to the diagram below for appropriate frame location.

Use this diagram for shelter size **10' x 20'** (3.0 m x 6.0 m) **only** (see page 7 for all other sizes).

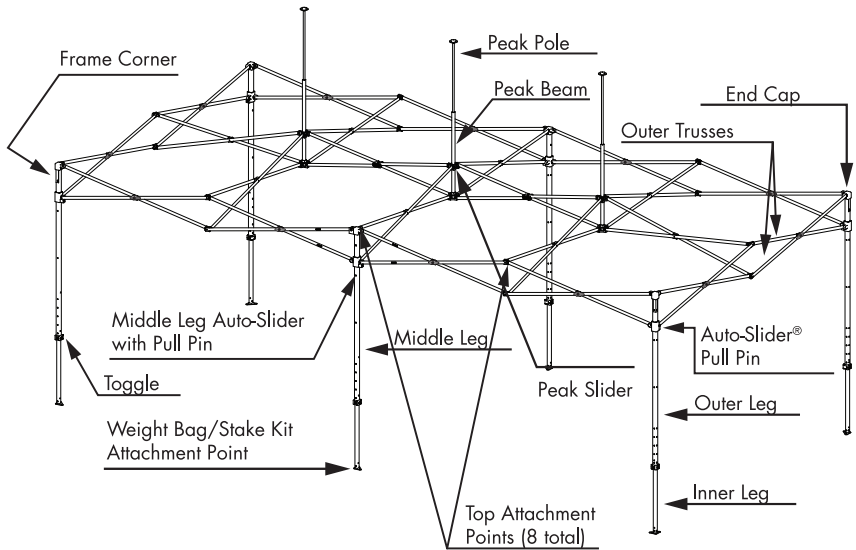

ONE-TIME TOP INSTALLATION

1

UNPACK AND OPEN

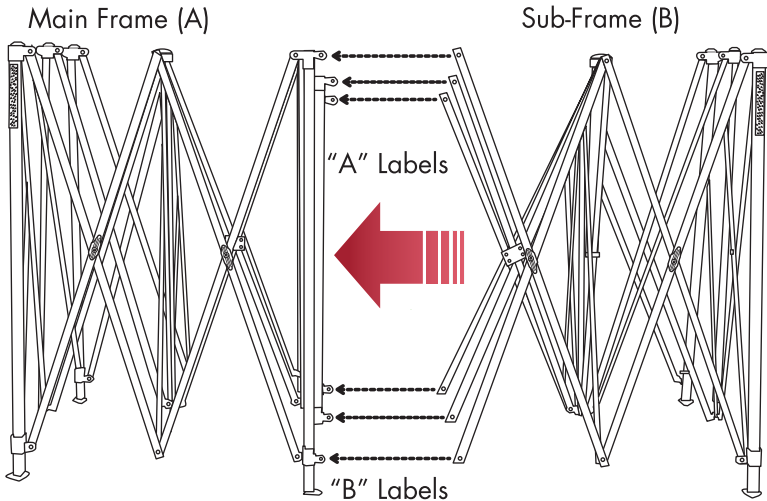

- A** With a partner on the opposite side of the frame, gently expand both the Main Frame (A) and Sub-Frame (B) to approximately half of their fully-opened size.
- B** Face open ends of the trusses to align the bracket attachment points on each frame.

ONE-TIME TOP INSTALLATION

2 CONNECT FRAMES

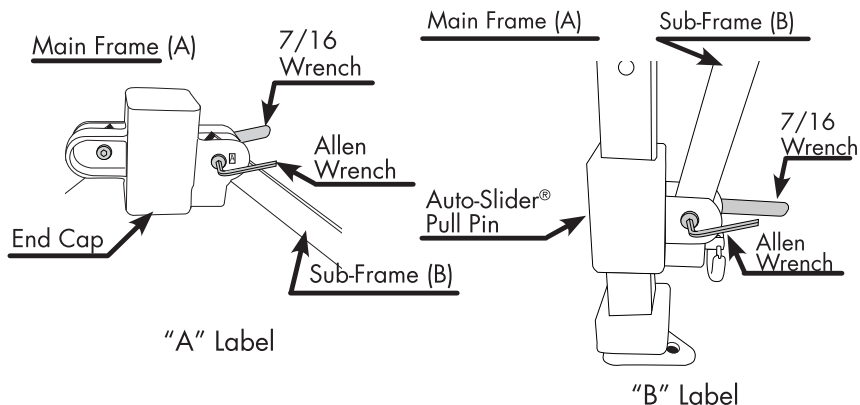

Attach the Main Frame (A) to the Sub-Frame (B) at each of the six connection points:

- A** Remove bolt assembly (nut and bolt) from each bracket on Main Frame (A).
- B** Insert truss end from Sub-Frame (B) (labeled "A" for top and "B" for bottom) into the corresponding attachment point on the Main Frame (A) and align holes.
- C** Use the nut and bolt that was previously removed to secure the truss. Tighten the nut and bolt securely using the enclosed allen wrench and 7/16 wrench.

Note: Do not over-tighten bolts—they should rotate easily. Connection points must rotate in order for shelter to open properly. Over-tightening will result in broken trusses.

- D** Repeat these steps for all six connection points (3 top points labeled "A" and 3 bottom points labeled "B").

ONE-TIME TOP INSTALLATION

3

OPEN FRAME

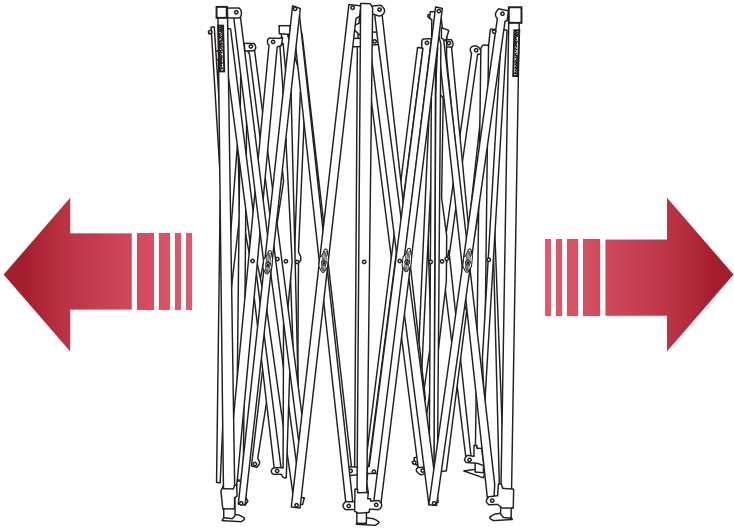

- A Place your E-Z UP[®] frame in the center of the area to be sheltered.
- B From the 10' (3.0m) side of the shelter, and with your partner on the opposite side, grasp two **outer legs**, lift the frame slightly off the ground, and pull the frame backwards to open the width of your outstretched arms. Set frame back on ground.
- C On the same 10' (3.0m) side, grasp the bottom of the diamond-shaped area of **center trusses** near the "OPEN HERE" stickers.
- D Lift frame up slightly and step backwards until the frame is approximately 3/4 of its fully-opened size.
- E Set frame back on the ground.

ONE-TIME TOP INSTALLATION

4 ATTACH FABRIC TOP

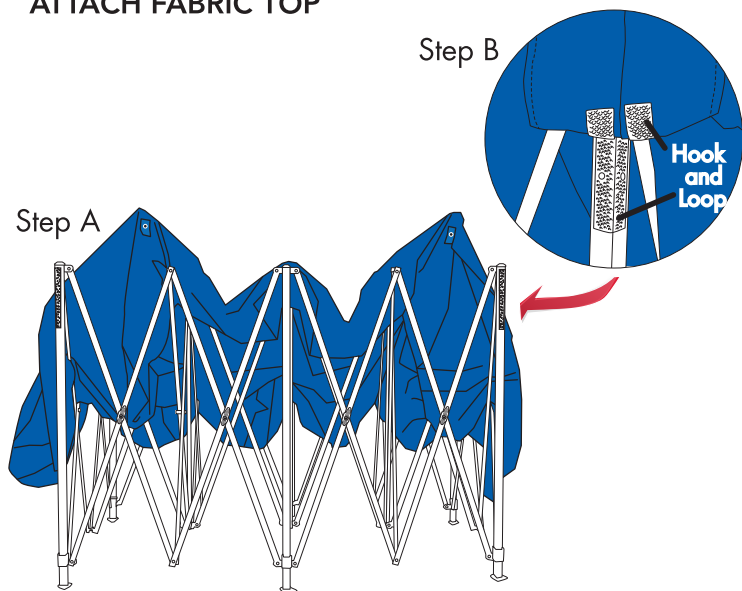

- A** Gently unfold the fabric top, and place it over the semi-opened frame. Identify the fabric corners and align them with the frame corners.

Note: To position top correctly, ensure that the E-Z UP® logo patch is located on the upper right corner of the longer frame side.

- B** Attach the fabric top to the E-Z UP® frame by matching the hook and loop strips on the inside of the fabric top corners with the hook and loop strips on each frame corner.
- C** Pull the fabric top down over the frame corners—pushing the hook and loop strips firmly together.

ONE-TIME TOP INSTALLATION

5 SECURE TOP TO FRAME

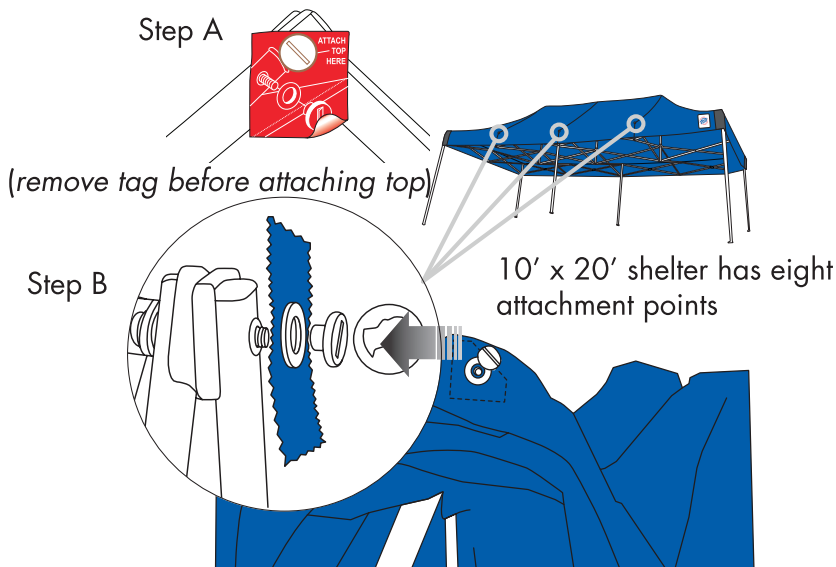

- A Line up the grommet holes on the sides of the fabric top. The top attachment points on the frame are denoted by the "RED" tags.
- B Using a coin, unscrew the top attachment nut from the frame bolt.
- C Place fabric top grommet on the frame bolt.
- D Screw on top attachment nut and tighten until snug. Top fabric should rotate easily. Do **not** over-tighten.
- E Repeat this procedure at each of the top attachment points.

Note: Hold the bolt assembly with one hand while tightening the top attachment nut with your other hand.

SETUP

1

OPEN E-Z UP® SHELTER

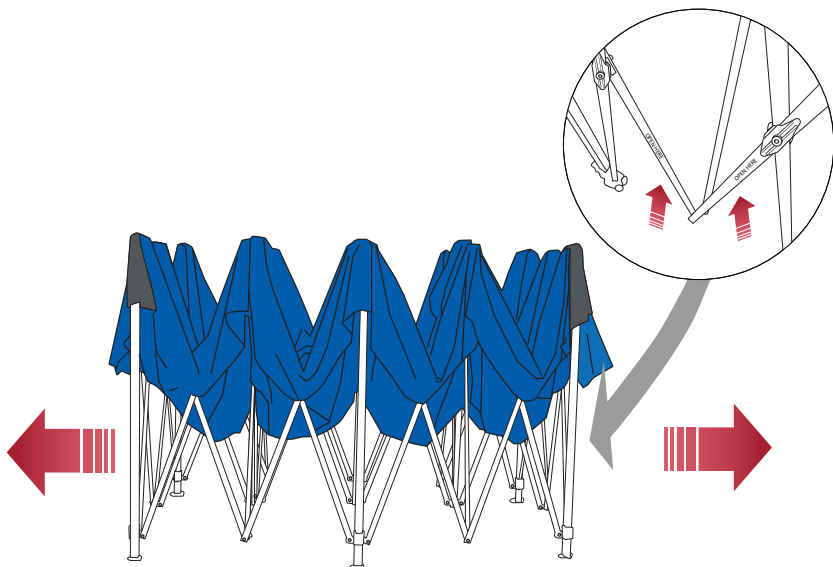

- A** With a partner on the opposite side, grasp the bottom of the diamond-shaped area of **center trusses** near the “OPEN HERE” sticker.
- B** Lift the frame up slightly and step backwards until the shelter is almost fully opened. Gently shake the shelter while opening. *Be careful not to pinch fingers!*

SETUP

2

SECURE AUTO-SLIDER® PULL PIN

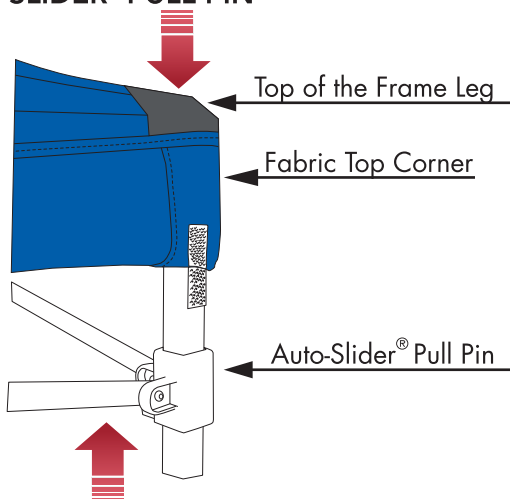

- A Fold up the corner valance to expose the **Auto-Slider® Pull Pin**.
- B Lift shelter corner slightly off the ground and engage the **Auto-Slider® Pull Pin** by pushing up on the frame side trusses with one hand while holding down the top of the frame leg with the other hand. The pins will auto-engage when aligned with the holes on the frame legs.
- C After the **Auto-Slider® Pull Pin** has locked into place, pull the fabric top down over the frame leg, making sure to align and secure the hook and loop strips on the fabric top to the frame.
- D Repeat on remaining legs by first engaging the four corners of the shelter BEFORE engaging the **Auto-Slider® Pull Pin** on the middle legs.

SETUP

3 EXTEND & SECURE FRAME LEGS

Leg Adjustment
Toggle Button

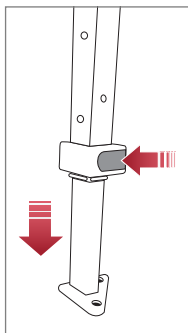

Stake Kit Weight Bag

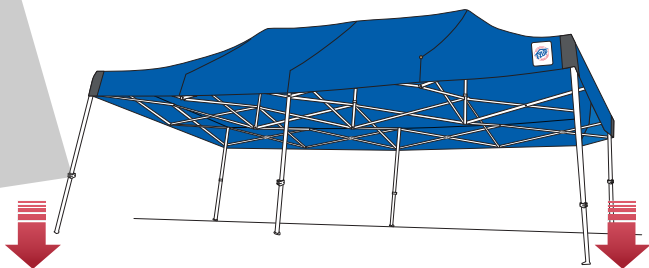

- A With a partner, lift two **outer legs** up off the ground simultaneously to about waist height.
- B Slide the **lower/inner legs** out until the leg adjustment toggle buttons lock at the selected height.
- C Lower **middle leg** until the toggle button locks.
- D Repeat on the opposite side. Be sure to adjust two legs at one time to avoid damaging frame.
- E **Note:** There are 5 height adjustment settings on each leg.

Your E-Z UP® shelter setup is now complete!

TAKE DOWN

1 COLLAPSE SHELTER LEGS

Leg Adjustment
Toggle Button

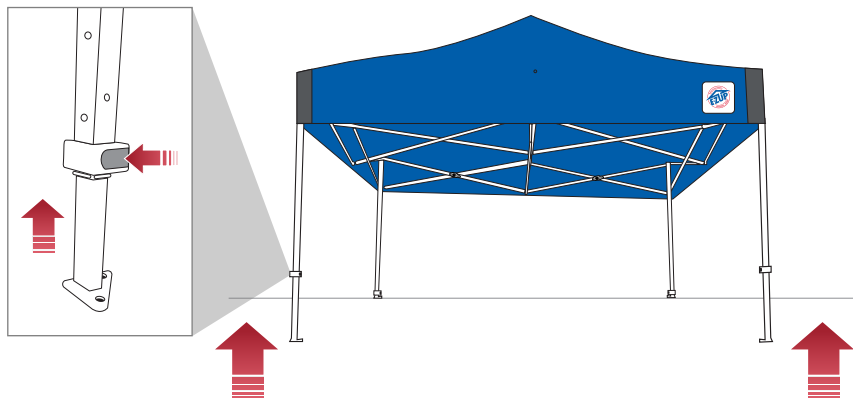

FOR 10' x 20' (3.0 m x 6.0 m) MODEL ONLY:

Depress the toggle button on one of the **middle legs** to slide the **lower/inner leg** into the **upper/outer leg**, then proceed with the instructions below.

FOR ALL MODELS:

- A With a partner, slightly lift two adjacent corner legs simultaneously.
- B Depress the toggle button and slide **lower/inner legs** into **upper/outer legs**, making sure to do two legs at a time on the same side.
- C Repeat on remaining legs.

Note: Keep the toggle button depressed while retracting leg.

TAKE DOWN

2 RELEASE AUTO-SLIDER® PULL PIN

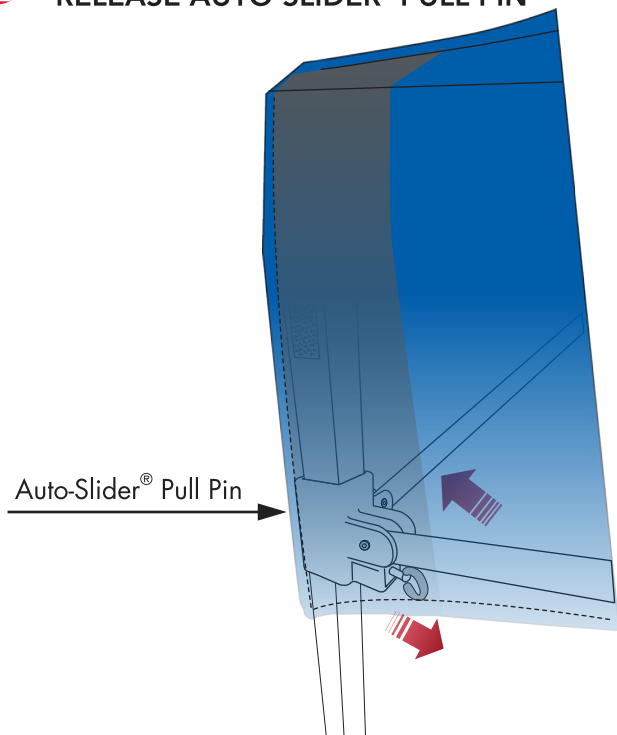

- A With one hand, slightly push up on the truss near the **Auto-Slider® Pull Pin** to relieve pressure.
- B With the other hand, release the **Auto-Slider® Pull Pin** by pulling the ring.
- C Repeat on remaining legs.

TAKE DOWN

3 CLOSING SHELTER

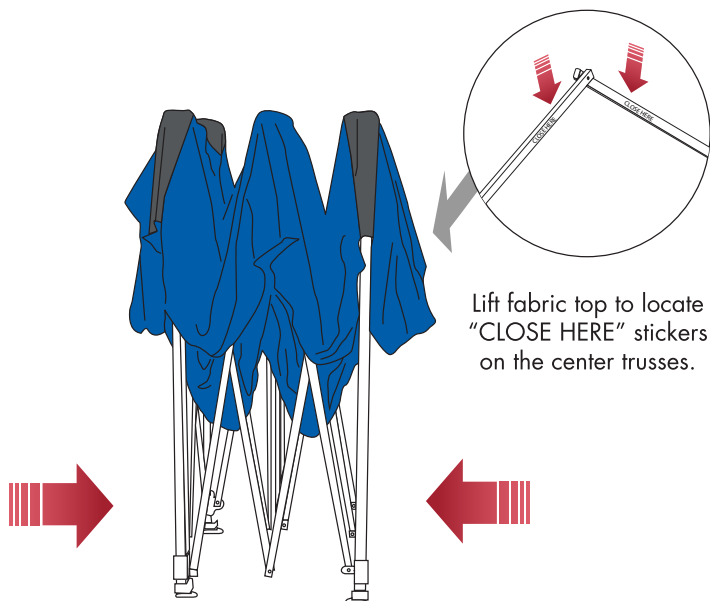

- A** Grasp the frame on the top of the diamond-shaped area of **center trusses** on the opposite sides near the "CLOSE HERE" sticker.
- B** Lift the shelter up slightly, and shake it while stepping towards your partner until the shelter is approximately 3/4 closed. *Be careful not to pinch fingers!*
- C** Grasp the two **outer legs**, and push the frame together until it is fully closed.
- D** Store the shelter in the cover bag provided.

Note: Hug your shelter before placing it in the cover bag. 😊

CARE AND MAINTENANCE

For long lasting durability and the best possible protection for your E-Z UP® Instant Shelter® products, follow these E-Z care and maintenance instructions:

Use a mild soap (not detergent) and plenty of water for the top cleaning.

Let the E-Z UP® top and frame dry completely before closing or storing to avoid mildew.

Frame will operate and look better if occasionally treated with silicone spray, especially before and after use in damp conditions. Remove excess silicone residue before applying top.

Use a seam sealer (available at most sporting goods and hardware stores) if top leaks or drips water.

Slightly tighten bolts if frame becomes loose.



WHAT MAKES E-Z UP THE LEADER IN CUSTOM-PRINTED SHELTERS?

KEEP IT ORIGINAL

That's our motto at E-Z UP. And, with our custom printing capabilities, you can create a truly one-of-a-kind shelter designed with your unique graphics.

EXPERT DESIGN SERVICES

From simple text to advance photo quality images, we can produce vibrant graphics of any complexity, using our advanced printing capabilities. Let our expert designers help you create amazing custom graphics that build your brand and generate sales or just look cool at the beach or on the sideline of your team's game.



AWARD WINNING GRAPHIC DESIGN & PRODUCTION

For multiple years, E-Z UP has won the Gold Award for Digital Printing by the Specialty Graphics Imaging Association. Consistently earning the highest honor for printing excellence from the graphics industry's leading authority designates E-Z UP as among the top specialty printers in the world. When you need the best Instant Shelter® with award winning digital printing, rely on the brand recognized by industry experts.

MORE THAN SHELTERS. SO MUCH MORE.

E-Z UP offers so much more than portable shelters. From flags and banners to stretch and fitted table covers, we offer the products you need to make your brand stand out from the crowd. And, we can print your custom graphics on nearly all the products we offer to create a truly original complete branding package.

Find out more about tents & accessories we have.