

USER MANUAL

UV & Solar Radiation Sensors

And Sensor Mounting Shelf
For Vantage Pro2™

Product numbers 6450, 6490, & 6673



DAVIS ®

UV and Solar Radiation Sensors and Sensor Mounting Shelf

The Davis UV Sensor (# 6490) is a precision radiometer that detects ultraviolet (UV) radiation at wavelengths of 290 to 390 nanometers. The spectral response is closely matched to the Erythema Action Spectrum, defined by McKinlay and Diffey (1987) and internationally recognized as the radiation that is most responsible for causing redness of the human skin.

The Davis Solar Radiation Sensor (#6450) is a precision pyranometer that detects radiation at wavelengths of 300 to 1100 nanometers. The spectral response of the silicon photodiode detector is a good match to the spectrum of solar irradiance.

Typically, both sensors are installed on the integrated sensor suite (ISS) using the Sensor Mounting Shelf (#6673). You may install only one of the sensors. Unless otherwise noted, instructions in this manual apply to both sensors. The sensors are compatible with any Vantage Pro2 ISS, as well as original Vantage Pro ISS.

Note: Sunburn is not the only consequence of exposure to UV radiation. Skin cancers, cataracts, and damage to the immune system are caused by UV radiation. Exposure to UV radiation should be minimized.

Both sensors have an outer shell, or shield, which protects the sensor body from thermal radiation and provides a path for convection cooling of the body, minimizing heating of the sensor interior. The shield has a built in bubble-level, and fins to aid in aligning the sensor with the sun's rays. The sensor body houses the diffuser, which is exposed through the top of the shield.

The Solar Radiation Sensor's body houses a precision-shaped diffuser giving excellent cosine response; a hermetically sealed silicon photodiode; and an amplifier.

The UV Sensor's shield provides a cutoff ring with a comb structure for cosine response. The UV sensor body houses the following components:

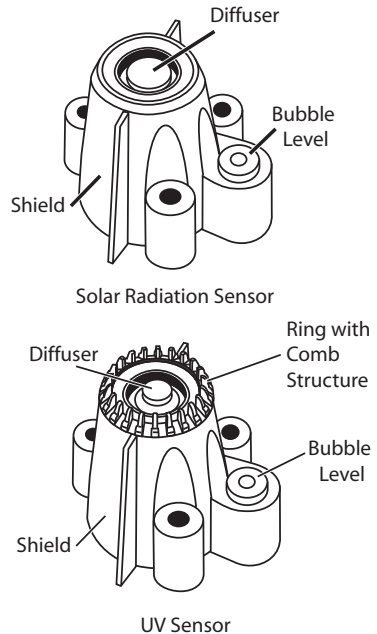

- **Diffuser:** With the comb structure of the shield, the precision-machined Teflon diffuser provides an excellent cosine response for zenith angles from zero to 90 degrees.
- **Transducer:** A latest-technology, hermetically-sealed hybrid microcircuit responds to UV irradiance according to the Erythema Action Spectrum.
- **Amplifier:** Converts the transducer output to a 0 to +2.5VDC signal.

Install the Sensor Mounting Shelf

Sensor Mounting Shelf Components

The Sensor Mounting Shelf includes the following components:

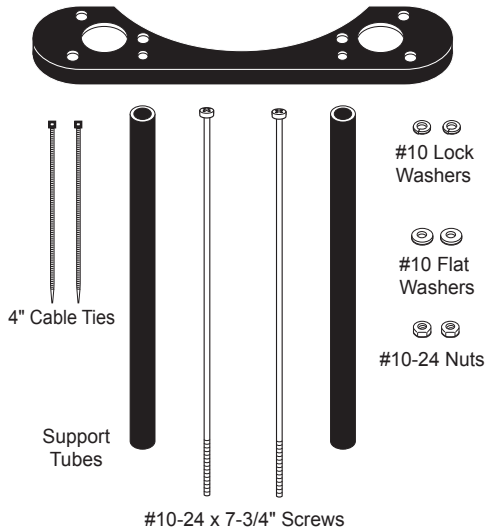

Use this illustration to identify which holes to use for the support tube screws.

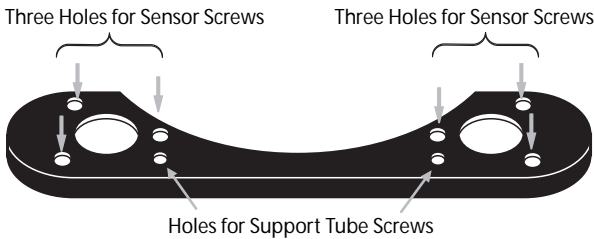

Mount the Sensor Mounting Shelf

Note: In the illustration, the rain collector cone has been removed for clarity. It is not necessary to remove the cone to install the Sensor Mounting Shelf.

1. Place a support tube on each of the outside mounting holes in the front of the rain collector base as illustrated.
2. Place a lock washer and a flat washer onto one of the 7-3/4" screws.
3. Locate the support tube mounting holes in the shelf. (See illustration on page 2.)
4. Insert the screw through the hole in the shelf, down through the tube and finally through the hole in the rain collector base.

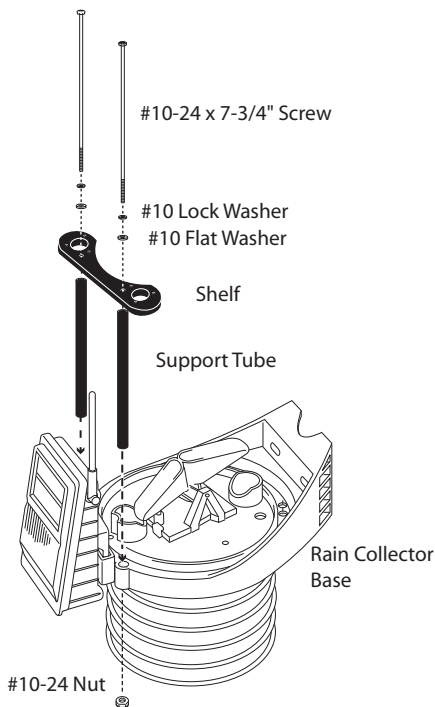

5. Place a nut in the opening of the hexagonal recess on the underside of the rain collector base.
6. Turn the screw until the assembly is loosely held together.
7. Repeat steps 1 - 6 with the second support tube and screw.
8. On the underside of the Sensor Mounting Shelf, verify that the tops of both support tubes are located inside the circular recesses in the shelf.
9. Tighten both support tube screws.

Test the Sensors

Before permanently installing your new sensor, you should test it. To do this, take your console with you out to your ISS, and follow the instructions below.

On the Vantage Pro2 ISS, open the transmitter shelter. See *Opening the Transmitter Shelter* in the *Vantage Pro2 ISS Installation* manual for more information.

1. Plug the UV Sensor cable into the receptacle labeled “UV”; plug the Solar Radiation Sensor into the receptacle labeled “SUN.”

With the sensor in sunlight, hold the sensor body with the white diffuser pointed upward. Do not touch the diffuser. If you do, clean it after mounting using a cotton swab and ethyl alcohol. Do not use rubbing alcohol.

2. On the Vantage Pro2 console, press 2ND then UV to see the UV Sensor reading and 2ND then SOLAR to see the Solar Radiation reading. The dashes should change to numbers as the sensor reports data. If you still see no reading after two minutes, reconnect the sensor cable to the ISS, ensuring it is in the proper receptacle. If you still see no reading, contact Davis Technical Support (see *Technical Support* at the back of this manual).

Note: The sensors update every 50 seconds to one minute.

3. Unplug the sensor cables from the sensor interface.

For permanent mounting, unplug the cable from the ISS and follow the instructions below. The test procedure is complete.

Securing the Sensor on the Shelf

Note: It does not matter which sensor is mounted on the right/left side of the shelf.

1. Remove the rain collector cone from the ISS: turn it counterclockwise until the latches allow you to lift it up and off.
2. Place the sensor shield onto the sensor body as shown. Be careful to avoid touching the diffuser.
3. Route the sensor cable down through one of the large holes in the mounting shelf. Place a flat washer over the end of each screw and insert it through the shield and body. Place a spring over the end of each screw and hold the springs in place using a #6 screw retainer.

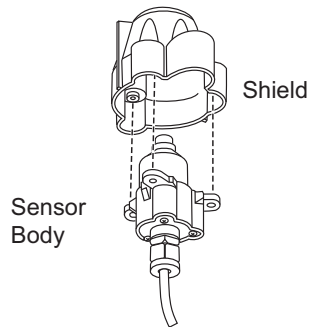

-
4. Secure the sensor to the mounting shelf by driving the screws into the appropriate holes as shown.

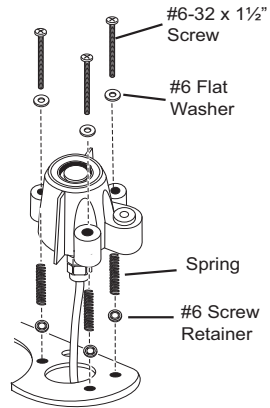

Note: The holes are not equidistant from each other, so the shield will not attach one way.

5. Using the bubble level on the sensor as a guide, adjust the sensor until it is level by tightening or loosening the screws. The top of the Solar Radiation sensor should be even with or slightly above the rim of the rain cone. The entire comb structure of the UV Radiation sensor should be above the rim of the rain cone.

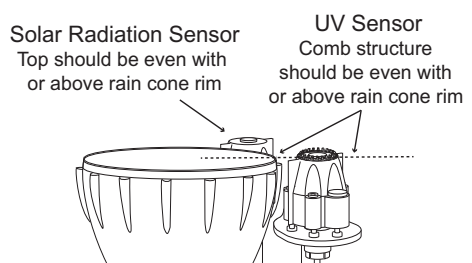

6. Repeat the above process to install an additional sensor. Replace the rain collector cone when finished.

Note: Final leveling of the sensor(s) should be done when the sensor suite is mounted in its operating location.

Routing the Sensor Cable

Run the cables down from the Sensor Mounting Shelf to the transmitter shelter. You can take up the slack by winding the cables around the posts under the rain collector base that connect the base to the radiation shield.

Open the shelter and remove the foam insert, and guide the cable through the access port. Insert the sensor plug into the proper receptacle (marked "SUN" for the Solar Radiation Sensor or "UV" for the UV Sensor) and replace the foam insert, ensuring that the foam insert fills all large voids in the access port. Ensure that the cables are free of crimps. Secure them to the support tubes with the provided cable ties so that they will not fray in the wind.

Note: Slide flat cables to the left to make more room in the access port.

Note: **Remember to change your device in WeatherLink.** If you use WeatherLink software or change your station from Vantage Pro2 to Vantage Pro2 Plus in order to see UV and Solar data.

Maintaining the Sensors

For the most accurate readings, clean the diffuser after mounting, and then periodically. Use ethyl alcohol (not rubbing alcohol).

Due to the sensitivity of ultraviolet and solar radiation sensors, it is common practice for manufacturers to recommend recalibration after a period of time. Here at Davis Instruments, we have seen approximately 2% drift per year on the readings from these sensors. For applications demanding higher accuracy, the sensors should be calibrated once every year.

Sensor Troubleshooting

Cable connections account for a large portion of the potential problems. Plugs should be firmly seated in the jacks and plugged in straight. Try jiggling the cable while looking at the display. If a reading appears intermittently on the display as you jiggle the cable, the connection is faulty.

