

Temperature Probes with 25-foot (7,6 m) cable

Product numbers 6475 & 6477

Your temperature probe may be used with the Sensor Transmitter or the wireless Weather Envoy. It can also be used with an EnviroMonitor Node with the RJ Connector Node Adapter (#6860). The sensor may be used to measure air, soil, or water temperatures.

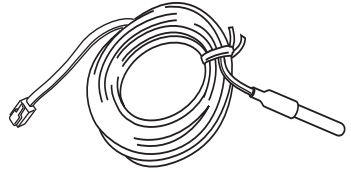

Tools and Materials Needed

You may need some of the following tools and materials to complete your installation.

- Shovel or spade to dig hole for sensor if using as a soil temp sensor
- Metal or plastic conduit to protect cable from rodents
- Cable clips or weather-resistant cable ties with screw holes or other means for mounting to secure cable

Testing the Sensor

Test the sensor before installing it.

1. Attach the sensor cable to the appropriate connector on the Envoy, Sensor Transmitter or Node. (Consult your product's User Guide for more information.)
2. Make sure you are getting an outside temperature reading on your console or other receiver. The sensor will report as "inside temperature."

Choosing a Location for the Sensor

Use the suggestions below to find a suitable location in which to mount the sensor. Care taken in choosing a location improves the accuracy, reliability, and durability of the sensor. The ideal location would be on the NORTH SIDE of a building (south side in the Southern Hemisphere).

Note: When choosing a location for the sensor you should take into consideration the objects nearby. Objects which heat up in direct sunlight or produce radiative cooling effects may affect temperature readings by changing the surrounding air temperature.

Look for a location which satisfies the following requirements:

- Place the sensor in a location where it will not be in direct sunlight and where it will have limited exposure to reflected sunlight.
 - Limit the exposure of the sensor to the open night sky.
 - Place the sensor at least 5 feet from man-made sources of heat.
 - Keep the sensor away from AC power lines.
 - If possible, place the sensor at least 5 feet from any surface which is exposed to direct sunlight because the heat from this surface may affect air temperature readings in the vicinity.
 - Place the sensor in a location at least 10 feet away from lights or lamps.
 - If you are unsure about a location's exposure to the night sky, check for dew at that location on a light dewy morning. If the area is dry, the location should work well.
-

-
- Keep the sensor and most of the cable at least 10 feet from 110 Vac, 60Hz utility power. Do not run the sensor cable parallel to house wiring. Mount the sensor at least 30 feet from high-voltage power lines and transformers.

Installing the Sensor

The illustration below shows typical installations for the Envoy in a Davis Universal Shelter (product no. 6618) mounted on a pole (left) and in a Sensor Transmitter (right) mounted on a pole.

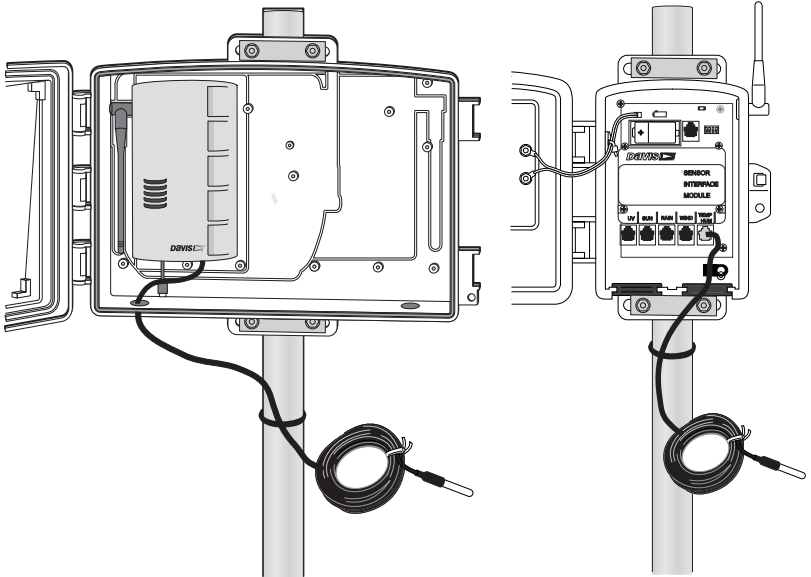

Mounting the Sensor

Depending on your use for this sensor, you may install it following the suggestions below:

- For air temperature, use a cable tie, cable clip, or electrical tape to attach the cable to a building, post, antenna mast, or other surface (make sure the sensor itself is not in contact with the building's surface). Consult the Radiation Shield manual for instructions on installing the sensor in a Radiation Shield.
- For soil temperature, bury the sensor at a depth suitable for your purposes. Where the cable runs along the ground, use metal or plastic conduits to protect the cable from rodents.
- For water temperature, drop the sensor into the water at a depth suitable for your purposes. If the cable runs along the ground at any point, use metal or plastic conduits to protect the cable from rodents.

In any case, to prevent fraying or cutting of the sensor cable where it is exposed to weather, it is important that you secure it so it doesn't whip about in the wind.

For example, you might want to use cable clips or weather resistant cable ties to secure the cable. Place clips or ties approximately every 3 to 5 feet (1 to 1.6 m). Do not use metal staples or a staple gun to secure cables. Metal staples — especially when installed with a staple gun — have a tendency to cut the cables.

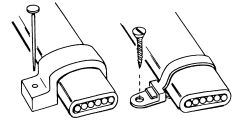

Note: When running the sensor cable, try not to tug on the cable in such a way as to loosen the connections. Also, make sure the sensor cable is not so taut that the connection may loosen or pull free due to the strain. Many sensor problems occur because cable connections come loose.

Sensor Output Specifications

Outside Temperature (Air)

Resolution and Units 1°F or 1°C (user-selectable)

Range -40° to +150°F (-40° to +65° C)

Sensor Accuracy ±1°F (±0.5°C) typical

Update Interval

When used with a Sensor Transmitter 10 seconds

When used with an Envoy 1 minute

Contacting Davis Technical Support

If you are having problems with the sensor, first check all cable connections. Connections should be firmly seated in the jacks and plugged in straight. If you think a connection may be faulty, try jiggling the cable while looking at the display. If a reading appears intermittently on the display, the connection is faulty. If you are unable to solve the problem, please call Davis Technical Support. We'll be glad to help. Most questions can be answered over the phone. You can also e-mail us for support or visit our web site.

Note: Please do not return items to the factory for repair before calling to get a Return Materials Authorization number.

Davis  [®]
Davis Instruments

External Temperature Probes

with RJ Connector and 25-Cable

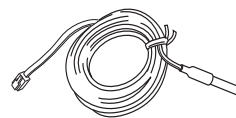

6475
6477

Vantage Pro2™ Accessories

The External Temperature Probes may be used with the wireless the Solar-Powered Sensor Transmitter (6332), AC-Powered Sensor Transmitter (6331), Weather Envoy (6316), and Envoy8X (6318). They can be used to measure air, soil or water temperatures.

The sensor is a precision platinum wire thermistor which produces a resistance change proportional to temperature. In the Stainless Steel model (6475), it is epoxy-encapsulated in a 316 alloy stainless steel body with vinyl strain relief. In the External Temperature Probe (6477), it is sheathed in vinyl.

To ensure accurate readings when measuring outdoor air temperature, the probe should be shielded from direct sunlight and other sources of reflected or radiated heat. We recommend the use of the Radiation Shield (#7714) for this purpose.

General

Sensor Type (see Charts)	Precision thermistor
Time Constant	
In Still Air	100 seconds
In Liquid	28 seconds
Attached Cable Length	25' (7.6 m)
Cable Type	4-conductor, 26AWG
Recommended Maximum Cable Length (see Note 1)	200' (61 m)

Note: There is no absolute maximum cable length. Increasing the cable length above the recommended maximum length causes an increased measurement error at a rate of approximately +0.24°F (+0.13°C) per 100' (30 m) of 22 AWG cable. See Figures 1 and 2, on page 2.

Housing Material	
6475	316 alloy stainless steel housing with vinyl strain relief
6477	Black vinyl
Housing Dimensions	
6475	0.312" diameter x 2.5" long (8 mm diameter x 64 mm long)
6477	0.25" diameter x 1.25" long (6.5 mm diameter x 32 mm long)
Weight	4.5 oz. (128 g)

Sensor Output

Resolution and Units	1°F or 1°C (user-selectable)
	Historical Graph Data and Alarms: 1°F or 1°C (user-selectable)
Range	-40° to +150°F (-40° to +65°C)
Sensor Accuracy	±1°F (±0.5°C) typical (see Figure 3)
Update Interval	
When used with Wireless Temperature Station	
or Anemometer/Sensor Transmitter Kit	10 - 12 seconds
When use with Weather Envoy or Envoy8X	1 minute

Charts

Figure 1 shows the resistance of the sensor. Figure 2 shows the cable-induced error of an un-calibrated sensor using 100' (30 m) of cable.

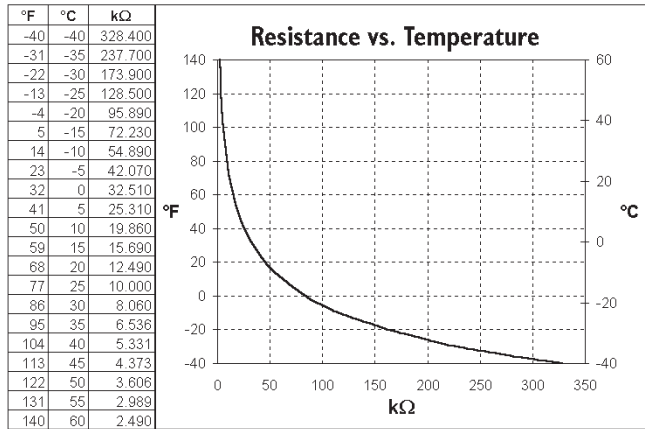

Figure 1

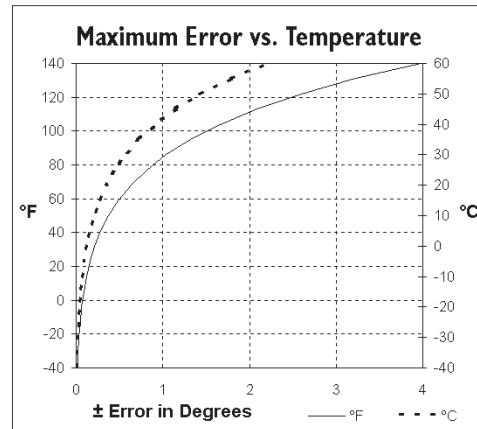

Figure 2

Figure 3 shows temperature accuracy for F and C.

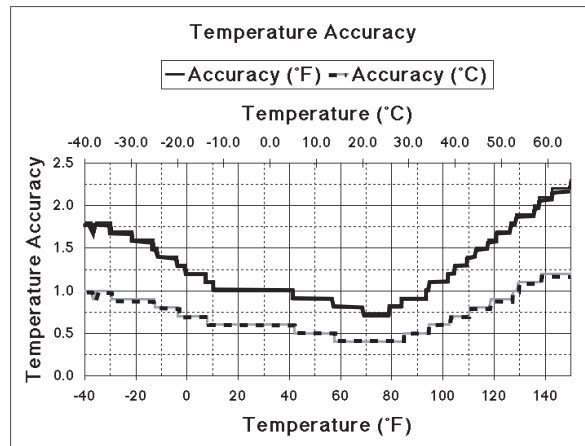

Figure 3

Package Dimensions

Product #	Package Dimensions (Length x Width x Height)	Package Weight	UPC Codes
6475	5.50" x 4.50" x 1.50" (140 mm x 115 mm x 38 mm)	5.8 oz. (.16 kg)	011698 009497
6477	5.50" x 4.50" x 1.50" (140 mm x 115 mm x 38 mm)	5.5 oz (.156 kg)	011698 009527