



# Operation Manual

## POWERLINE<sup>®</sup> BY Daisy<sup>®</sup> Model 35 Multi-Pump Pneumatic Air Rifle



### DO NOT RETURN



this airgun to the retail store where you purchased it. If you are dissatisfied with the quality or performance of this airgun, please call Customer Service. Please fill out the attached card and return it with a copy of your dated sales receipt (for proof of purchase use only) along with your airgun.

### READ YOUR OPERATION MANUAL AND ALL WARNINGS BEFORE USING.

**⚠️ WARNING:** NOT A TOY. ADULT SUPERVISION REQUIRED. MISUSE OR CARELESS USE MAY CAUSE SERIOUS INJURY OR DEATH. MAY BE DANGEROUS UP TO 333 YARDS (304 METERS).

THIS IS A HIGH POWER AIR GUN RECOMMENDED FOR USE BY THOSE 16 YEARS OF AGE OR OLDER. READ ALL INSTRUCTIONS BEFORE USING. THE PURCHASER AND USER SHOULD CONFORM TO ALL LAWS GOVERNING USE AND OWNERSHIP OF AIR GUNS.

#### ACCORDING TO CALIFORNIA LAW

**⚠️ WARNING:** DO NOT BRANDISH OR DISPLAY THIS AIRGUN IN PUBLIC - IT MAY CONFUSE PEOPLE AND MAY BE A CRIME. POLICE AND OTHERS MAY THINK THIS AIRGUN IS A FIREARM. DO NOT CHANGE THE COLORATION AND MARKINGS TO MAKE IT LOOK MORE LIKE A FIREARM. THAT IS DANGEROUS AND MAY BE A CRIME.

**⚠️ WARNING:** EVEN IF YOU FIRED THE AIRGUN ONE OR MORE TIMES AND NO BB IS EXPELLED, IT DOES NOT MEAN THAT THE GUN IS EMPTY OF BBs. CONTINUE TO TREAT THE AIRGUN AS IF IT IS LOADED.



## 10 SHOOTING SAFETY RULES

**⚠️ WARNING** FAILURE TO FOLLOW THESE RULES CAN RESULT IN SERIOUS INJURY OR DEATH.

1

**Always keep the muzzle pointed in a safe direction.** There are several safe "carries" depending on the situation. NEVER ALLOW THE MUZZLE TO POINT IN THE DIRECTION OF A PERSON.

2

**Treat every gun as if it were loaded.** You can never be positive that you were the last person to handle the gun. Never take anyone's word about whether or not a gun is loaded. Always check a gun to see if it is loaded when removed from storage or received from another person. Even if you have fired an airgun one or more times and no pellet or BB was expelled from the barrel, it does not mean that the magazine of the gun is empty of ammunition. Any airgun can fail to feed for any number of reasons. Continue to treat the airgun as loaded and ready to fire. ALWAYS TREAT A GUN AS IF IT IS LOADED EVEN IF YOU KNOW IT ISN'T.

3

**Only load or cock a gun when you are shooting.** A loaded gun has no place in your home or other public place.

4

**Check your target and beyond your target.** Be sure all persons are well clear of the target area before you shoot. Check behind and beyond your target to be certain you have a safe backstop and that no person or property could be endangered.

5

**Anyone shooting or near a shooter should wear shooting glasses.** Also, all other persons should remain behind the shooter.

6

**Never climb or jump with a gun.** You can't control the direction of the muzzle if you stumble or fall. You should safely lay the gun down or hand it to a companion while you climb or jump over anything.

7

**Avoid ricochet.** Never shoot at a flat hard surface or at the surface of water. Ammunition can ricochet off of water just like a skipped rock.

8

**Keep the muzzle clear.** Never let anything obstruct the muzzle of a gun. Don't allow the muzzle to come in contact with the ground.

9

**Guns not in use should always be unloaded.** Keeping guns unloaded when not in use is critical to the safety of you and others. When you are finished shooting, put the trigger safety in the "on" position and unload the gun. Store guns so that they are inaccessible to untrained shooters and store ammunition separately from the gun.

10

**Respect other people's property.** Whether you're target shooting or hunting, if you're a guest on others' land, you should leave it exactly as you found it.

# OPERATION MANUAL

# POWERLINE®

BY **Daisy**

## Model 35 Multi-Pump Pneumatic Air Rifle

B•B Cal. (4.5 mm) Steel Air Gun Shot Ⓢ  
.177 Cal. (4.5mm) Lead Airgun Pellet ☒

**WARNING:** DAISSY RECOMMENDS LEAD-FREE PELLETS FOR SHOOTERS 12 YEARS OF AGE OR UNDER.

**WARNING:** NOT A TOY. ADULT SUPERVISION REQUIRED. MISUSE OR CARELESS USE MAY CAUSE SERIOUS INJURY OR DEATH. MAY BE DANGEROUS UP TO 274 YARDS (251 METERS).

THIS IS A HIGH POWER AIR GUN RECOMMENDED FOR USE BY THOSE 16 YEARS OF AGE OR OLDER. READ ALL INSTRUCTIONS BEFORE USING. THE PURCHASER AND USER SHOULD CONFORM TO ALL LAWS GOVERNING USE AND OWNERSHIP OF AIR GUNS.

### ACCORDING TO CALIFORNIA LAW

**WARNING:** DO NOT BRANDISH OR DISPLAY THIS AIRGUN IN PUBLIC - IT MAY CONFUSE PEOPLE AND MAY BE A CRIME. POLICE AND OTHERS MAY THINK THIS AIRGUN IS A FIREARM. DO NOT CHANGE THE COLORATION AND MARKINGS TO MAKE IT LOOK MORE LIKE A FIREARM. THAT IS DANGEROUS AND MAY BE A CRIME.

**WARNING:** THIS GUN CAN CAUSE DEATH. READ AND FOLLOW THE INSTRUCTIONS CAREFULLY. DO NOT LOAD A BB OR PELLET INTO THE CHAMBER UNTIL YOU ARE READY TO SHOOT. IF YOU DO LOAD A BB OR PELLET AND DECIDE NOT TO SHOOT, REMOVE EITHER MANUALLY OR BY SHOOTING IT IN A SAFE DIRECTION. AN UNCOCKED, UNLOADED GUN IS SAFEST. ACCIDENTS HAPPEN FAST, AND ACCIDENTALLY INJURING OR KILLING SOMEONE IS A TERRIBLE THING. SHOOT SAFELY.

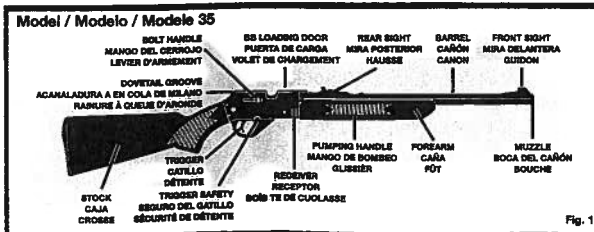

**WARNING:** This safety alert symbol indicates important safety messages in this manual. When you see this symbol, be alert to the possibility of personal injury and carefully read the message that follows.

This air gun shoots with much more power than the traditional spring air BB gun. More power means greater chance of serious injury or death.

Although your new PowerLine Air Rifle is not a firearm, it has lethal potential and should be treated with the caution and respect due any conventional firearm. Like a firearm, your PowerLine Air Rifle, when misused or carelessly used, can kill or seriously injure the shooter or other persons.

Always remember, the first and most important safety aspect of any gun is the shooter. All safeties are mechanical devices and the shooter is the only part of the system that can make a gun safe—or unsafe. **DON'T DEPEND ON MECHANICAL SAFETIES;** think ahead and avoid situations that might lead to accidents.

Guns differ in their operations and you are never ready to fire any gun until you are thoroughly familiar with it. Read the following operating instructions and **WITHOUT LOADING A PROJECTILE**, proceed several times through the operating steps with your gun (dry fire the gun at a safe target) so that you will be able to operate the PowerLine Air Rifle properly and safely.

## HOW TO OPERATE

**CAUTION:** Be sure gun is always pointed in a safe direction

- Step 1. OPEN BOLT
- Step 2. PUT "ON" TRIGGER SAFETY
- Step 3. PUMP
- Step 4. LOAD
- Step 5. CLOSE BOLT
- Step 6. AIM AT SAFE TARGET
- Step 7. TAKE "OFF" TRIGGER SAFETY
- Step 8. FIRE

### Step 1. OPEN BOLT

Pull straight back on bolt handle, pulling it fully to the rear (Fig. 2). The gun cannot fire with bolt open.

### Step 2. PUT "ON" TRIGGER SAFETY

The bolt must **FIRST** be opened, then the trigger safety is pushed from the left to right so that **NO** red is showing (Fig. 3).

**CAUTION:** Gun must always be pointed in a safe direction.

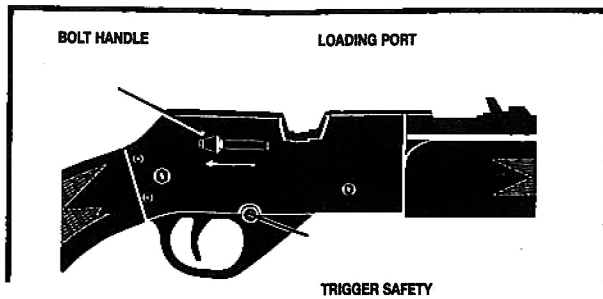

Fig. 2

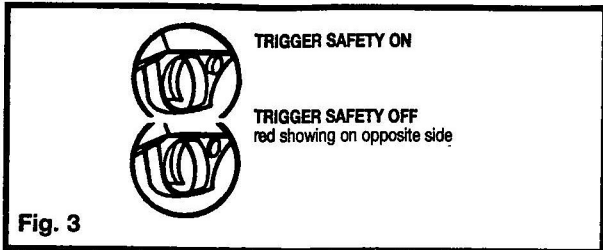

Fig. 3

### Step 3. PUMP

The bolt must be opened to pump gun. For greater safety, we recommend that the bolt remain open while pumping and that you close the bolt only when the barrel can be pointed in a safe direction. With the muzzle pointed in a safe direction, pump the gun the desired number of times up to 10. More power means greater chance of serious injury. Never put finger on trigger until ready to fire the gun. **NOTE:** Do not pump your gun more than 10 times. Muzzle energy increases produced by more than 10 pumps are minor, and increased pumping will damage your gun.

**CAUTION:** Be sure to grasp the forearm firmly as you close it to prevent it from snapping back and causing possible injury. Also be careful to keep fingers out of cocking mechanism when closing forearm. (See "Pinch Points", Fig. 4).

**WARNING:** Do not open the bolt, close the bolt, and then pull the trigger before pumping. This procedure can result in a loaded gun and a projectile being expelled from the gun during pumping. Recock the gun by opening the bolt and put "ON" trigger safety before pumping as in Steps 1 and 2.

We recommend the following number of pumps for different shooting conditions.

- For indoor shooting, 2 pumps
- For 10-meter (33-ft.) distance, 4 to 6 pumps.
- For longer distances, 7 to 10 pumps.

**NOTE:** Never pump more than 10 times. Over pumping will cause serious damage to the gun.

	BBs	PELLETS
MUZZLE VELOCITY (10 PUMPS)	625 fps - 191 mps	605 fps - 184 mps
SHOOTING DISTANCE (10 PUMPS)	274 yds. - 251 m	265 yds. - 242 m

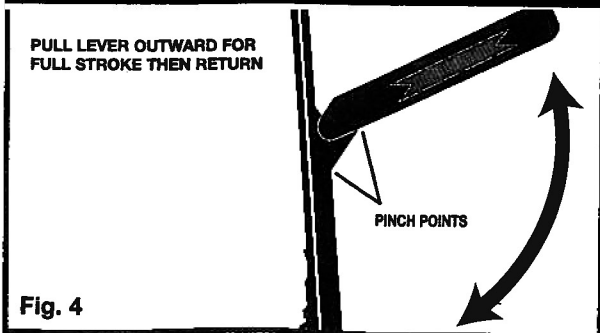

Fig. 4

### Filling the BB magazine for the PowerLine 35:

The loading door is located on the left side of receiver (Fig. 5). Push door down and fill magazine with approximately 50 BBs. Do not overfill or the feed system may not operate properly.

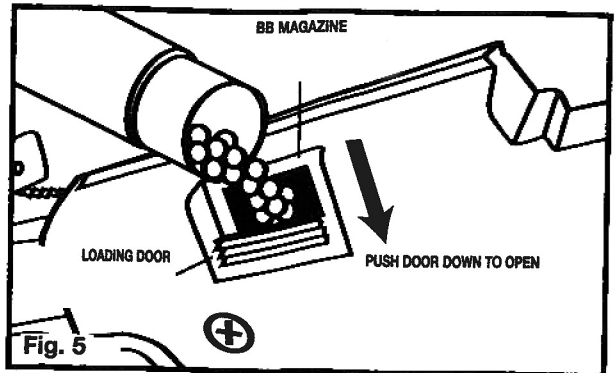

Fig. 5

### Step 4. LOAD

**LOADING BBs - (Fig. 6):** With the bolt handle back and BBs in the magazine. RAISE the muzzle of the gun 45 degrees to 90 degrees. When raising the muzzle, be sure the front sight is pointed upward since the gun may not feed properly if it is on its side.

A BB can be seen on the magnetic tip by looking into the loading port. If a BB does not feed onto the magnetic tip when the muzzle is raised, shake the gun slightly. Push bolt handle fully forward and the BB is in firing position. Be sure the front sight is pointed upward when raising the muzzle to insure proper feeding.

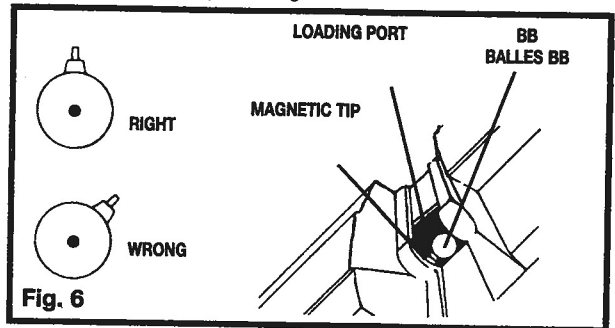

Fig. 6

**CAUTION:** Always view the BB or Pellet when closing the bolt and loading port.

**WARNING:** BBs feed from the magazine by gravity which requires that the muzzle be raised. **NEVER ASSUME THE MAGAZINE OR CHAMBER IS EMPTY** even if the gun does not fire a projectile.

**LOADING PELLETS:** With the bolt back and BBs removed from the magazine (See "TO EMPTY MAGAZINE," Page 9), advance the bolt forward until the magnetic tip is visibly even with the rear edge of the pellet loading port; lower the muzzle and load a pellet, solid end forward (Fig. 7). Push the bolt handle fully forward and the pellet is chambered in the firing position.

**IMPORTANT:** Do not allow a pellet to fall into the rear of the loading port and become jammed in the BB feed hole. If this occurs, have a qualified gunsmith remove the left receiver and clear the loading port or return gun to Daisy.

**IMPORTANT:** Care must be exercised when shooting pellets while the magazine contains BBs. Loading a BB and pellet at the same time may result in a jammed or obstructed barrel.

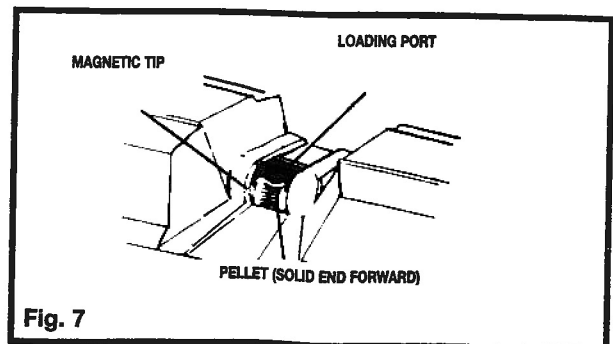

Fig. 7

### Step 5. CLOSE BOLT

Close bolt by pushing fully forward on bolt handle to chamber either a BB or pellet and lock the bolt.

**CAUTION:** The gun is now loaded and ready to fire.

### Step 6. AIM AT SAFE TARGET

Aim the gun at a safe target. To be a consistent marksman, use the correct sight picture each time you fire your gun (Fig. 8). **Never point a gun, loaded or unloaded, at anyone.**

**CAUTION:** Due to the power of this air gun, use extra caution in selecting a safe target backstop. Select the proper target and backstop based on the ammunition you are shooting. BBs should NEVER be shot into a pellet trap. Pick targets with a backstop that cannot be penetrated or that will not cause ricochet because of their hard surface. Use only targets and traps that are designed for use with high power air guns. Do not shoot at water.

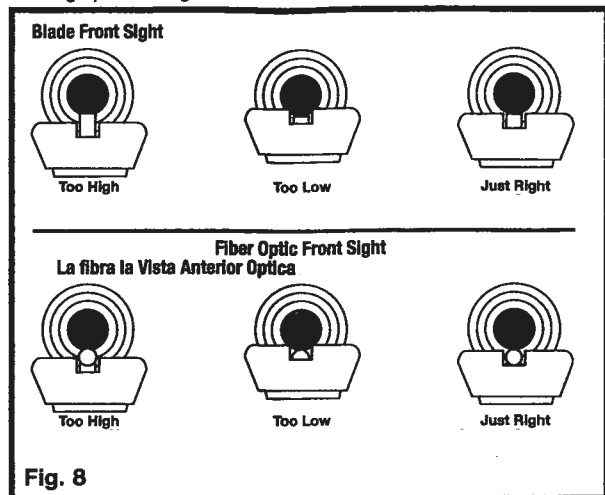

Fig. 8

### Step 7. TAKE "OFF" TRIGGER SAFETY

When you are certain the target, backstop and surrounding area is safe, take trigger safety "OFF" by pushing from right to left so that red is exposed. Your gun is now cocked and ready to shoot. In this condition, it should be handled with extreme care.

### Step 8. FIRE

After making sure the gun is pointed in a safe direction, gently (but firmly) squeeze the trigger. Repeat Steps 1 through 8 to continue shooting, using the appropriate loading procedure. **NOTE:** To fire, bolt must be completely closed as indicated in Step 5.

**CAUTION:** Do not leave your gun pumped for an extended period of time. This could result in a time delay from the time the trigger is pulled until the projectile is expelled from the gun. Also, leaving your gun pumped for more than one hour could result in permanent damage to the air release valve.

**WARNING:** If a BB or pellet does not fire after completing the operation steps, the gun is jammed. This is a dangerous condition.

### CLEARING A JAM

Open the bolt and put "ON" trigger safety immediately. If the bolt is not completely closed, do not try to close it until after opening it by pulling the bolt handle all the way back. The gun will not fire a projectile when the bolt is completely open.

Repeat all operations except Step 4 (do not load BB or pellet), pumping gun up 10 times. If a projectile still does not fire, follow these steps carefully:

1. Open bolt.
2. Put trigger safety "ON".
3. Clear barrel by running a cleaning rod through from the muzzle end. Be careful not to damage the bolt tip by pushing the rod through too hard. Do not reuse this BB or pellet.
4. Repeat operation steps. Make sure a BB or pellet is fed into firing position. If after following the firing procedure the projectile is not fired, return your gun to Daisy (See REPAIR OF DAISY GUNS" section).

### UNLOAD PELLETS:

The magnetic tip does not extract a pellet. You must shoot the pellet out if a safe target is available. If a safe target is not available, open bolt, put trigger safety "ON", insert a cleaning rod in the muzzle end and push the

pellet out of the barrel. Do not allow a pellet to fall into the rear of the loading port and become jammed in the BB feed hole.

### TO EMPTY BB MAGAZINE:

Open bolt and put trigger safety "ON". Open the BB magazine door, cup your hand over it and tilt the gun fully to the left side. Shake gun until all BBs are removed. Then remove BBs from loading port (Fig. 2).

**WARNING:** Even if you have fired the airgun one or more times and no BB or pellet was expelled, it does not mean that the gun is empty of ammo. Continue to treat the airgun as it is loaded.

**WARNING:** Never assume gun is empty of projectiles. Always point the gun in a safe direction.

### REAR SIGHT ADJUSTMENT:

Your air gun is equipped with an adjustable rear sight.

#### HOW TO ADJUST SIGHT RIGHT OR LEFT (WINDAGE):

Loosen screw "A" by turning counterclockwise (Fig. 9). Move rear sight to the right side of the gun to make it shoot to the right, or to the left side of the gun to make the gun shoot to the left. Make certain screw "A" is retightened after adjustment.

#### HOW TO ADJUST SIGHT UP OR DOWN (ELEVATION):

Raise the rear sight by moving sight elevator back to make the gun shoot higher. Lower the rear sight by moving the sight elevator forward to make the gun shoot lower (Fig. 10).

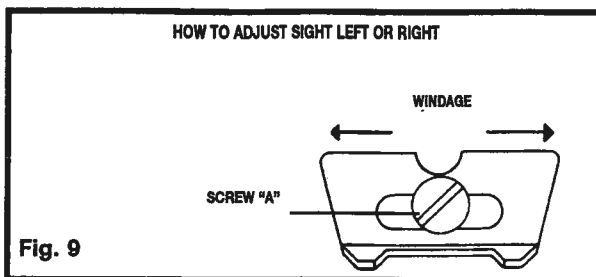

Fig. 9

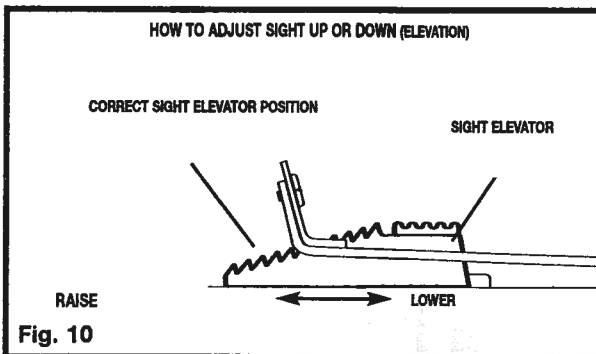

Fig. 10

### PROPER CARE

To maintain top shooting performance, lightly oil the three pumping lever hinges and the felt wiper on the piston every 1,000 shots (Fig. 11). Use a 10-, 20- or 30-weight non-detergent, automotive motor oil. **DO NOT** use light, household type oils or aerosol type spray lubricants since they may contain substances or additives harmful to the rubber seals or other components. Clean the exterior by wiping with a soft, clean, lightly oiled cloth. The screws are a gun blue finish; wipe with oil to prevent rust.

**CAUTION:** Improper lubricants, such as aerosol type spray lubricants, can ignite (diesel) during pumping. Use only automotive motor oils.

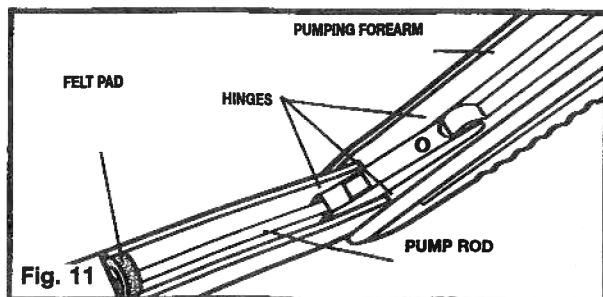



Fig. 11

## STORAGE

Before putting the gun away in a cabinet or gun rack, shoot the gun at a safe target to make sure the pump system and barrel are empty. Then, open the bolt and place the trigger safety "ON", then close the bolt. Always make sure the gun is empty and the trigger safety is "ON" before storage; the gun should also be clean, dry and oiled.

Store projectiles in a separate location from the gun to keep it away from untrained shooters.

 **WARNING:** Even if you have fired the airgun one or more times and no BB or pellet was expelled, it does not mean that the gun is empty of ammo. Continue to treat the airgun as it is loaded.

## MODIFICATION

 **WARNING:** The components of this gun were engineered to deliver optimum performance. Any modification or tampering with a gun may cause a malfunction and may make it unsafe to use. Any change in performance, such as a lowered trigger force and shortened trigger travel, indicates possible wear, and such gun should be inspected, replaced or properly repaired by qualified personnel. Any gun that has been dropped should be checked by qualified personnel to insure that its function has not been effected.

 **WARNING:** A gun that is not operating properly may be dangerous. It should be kept safely from use by anyone until repaired or destroyed. DO NOT try to take the gun apart. It is difficult to reassemble, and improper reassembly can cause a hazardous condition.

## GUNS IN WARRANTY

### LIMITED ONE – YEAR WARRANTY

For one year from date of purchase, Daisy will repair or replace this gun, free of charge, if defective in material or workmanship. Service is available by returning the gun to Daisy Outdoor Products. Attach to the gun your name and address and telephone number, description of problem and proof of date of retail purchase (sales slip). Package and send to Daisy Outdoor Products, transportation pre-paid. This Warranty gives you specific legal rights, and you may also have other rights which may vary from state to state.

## SPECIFICATIONS: PowerLine® 35

<b>ACTION</b>	Multi-pump pneumatic
<b>AMMUNITION</b>	.177 cal. (4.5mm) BB or pellet
<b>BARREL</b>	Smooth bore steel
<b>SIGHTS</b>	Blade and ramp front/Adjustable rear
<b>STOCK/FOREARM</b>	Molded stock & forearm with checkering
<b>SAFETY</b>	Cross bolt trigger block
<b>CAPACITY</b>	50-shot BB; single-shot pellet
<b>OVERALL LENGTH</b>	34.5 in. (87.6cm)
<b>WEIGHT</b>	3.1 lbs. (1.5 kg)
<b>TARGET DISTANCE</b>	33ft (10m)
<b>MAX. VELOCITY*</b>	625 FPS (BB)
<b>MAX. SHOOTING DISTANCE**</b>	274 yds

\*Indicates 10 pumps \*\*With muzzle pointed upward at optimum angle