

BOUNTY HUNTER®

LAND RANGER™ *Pro* METAL DETECTOR



OWNER'S MANUAL

Use 9-volt
ALKALINE batteries.

Do not use
"Heavy Duty" batteries.

Do not use
ordinary "Zinc Carbon" batteries.

Congratulations!

Congratulations on the purchase of your new Bounty Hunter® *Land Ranger™ Pro* Metal Detector. The *Land Ranger Pro* is the result of nine years of software engineering and features the latest advancements in lightweight design, target accuracy and deep-penetrating detection technology.

The *Land Ranger Pro* can be used with its default turn-on-and-go settings or it can be customized for any of your treasure hunting applications with its unique features like Enhanced V-Break®, High Resolution Conductivity Arc and Program Memory, as well as Manual and Automatic Search Modes. Treasure hunting enthusiasts from around the world were involved in the development of this revolutionary new detector. This manual has been written to help you get optimal use of your detector so we hope you will read it thoroughly before your first outing.

Happy Hunting from First Texas Products!

TABLE OF CONTENTS

Terminology	3
Contents	4
Assembly	5
Batteries (use alkaline batteries)	6
Quick-Start Demonstration	7
The Basics of Metal Detecting	8-9
How to Work the Controls	10
The Display	11
Target Identification	12
Operation and Control	13
Menu	14-16
Operating Modes	17
Pinpoint	18
Ground Cancellation	19-20
Headphones	20
Depth and Target Display	21
Troubleshooting	22
Treasure Hunter's Code of Ethics	23
Warranty	23
Accessories	24

TERMINOLOGY

The following terms are used throughout the manual, and are standard terminology among detectorists.

RELIC

A relic is an object of interest by reason of its age or its association with the past. Many relics are made of iron, but can also be made of bronze or precious metals.

IRON

Iron is a common, low-grade metal that is an undesirable target in certain metal detecting applications. Examples of undesirable iron objects are old cans, pipes, bolts and nails.

Sometimes, the desired target is made of iron. Property markers, for instance, contain iron. Valuable relics can also be composed of iron; cannon balls, old armaments and parts of old structures and vehicles can also be composed of iron.

FERROUS

Metals which are made of, or contain, iron.

ELIMINATION

Reference to a metal being "eliminated" means that the detector will not emit a tone, nor display a Target-ID, when a metal object passes through the searchcoil's detection field.

DISCRIMINATION

When the detector emits different tones for different types of metals, and when the detector "eliminates" certain metals, we refer to this as the detector "discriminating" among different types of metals.

Discrimination is an important feature of professional metal detectors.

Discrimination allows the user to ignore trash and otherwise undesirable objects.

PINPOINTING

Pinpointing is the process of finding the exact location of a buried object. Long-buried metals can appear exactly like the surrounding soil, and can therefore be very hard to isolate from the soil.

V.C.O.

Meaning "voltage controlled oscillator," the V.C.O. audio method causes both the *audio pitch* and the *volume* to rise as signal strength increases. V.C.O. improves the user's ability to interpret a target's size and depth. Very weak signals (for small or very deeply buried objects) have the faintest volume and the lowest pitch. Larger objects, and those closer to the searchcoil, will induce a higher volume and higher pitch sound.

GROUND CANCELATION

Ground Cancellation is the ability of the detector to ignore, or "see through," the earth's naturally occurring minerals, and only sound a tone when a metal object is detected. This detector incorporates proprietary circuitry to eliminate false signals from many mineralized soils.

CONTENTS OF BOX

The following detector components are in the box:

1. S-ROD with Control Housing, Arm Rest and Locking Collar
2. Lower Stem
3. Searchcoil
4. Bolt & Knurled Knob
5. This Owner's Manual

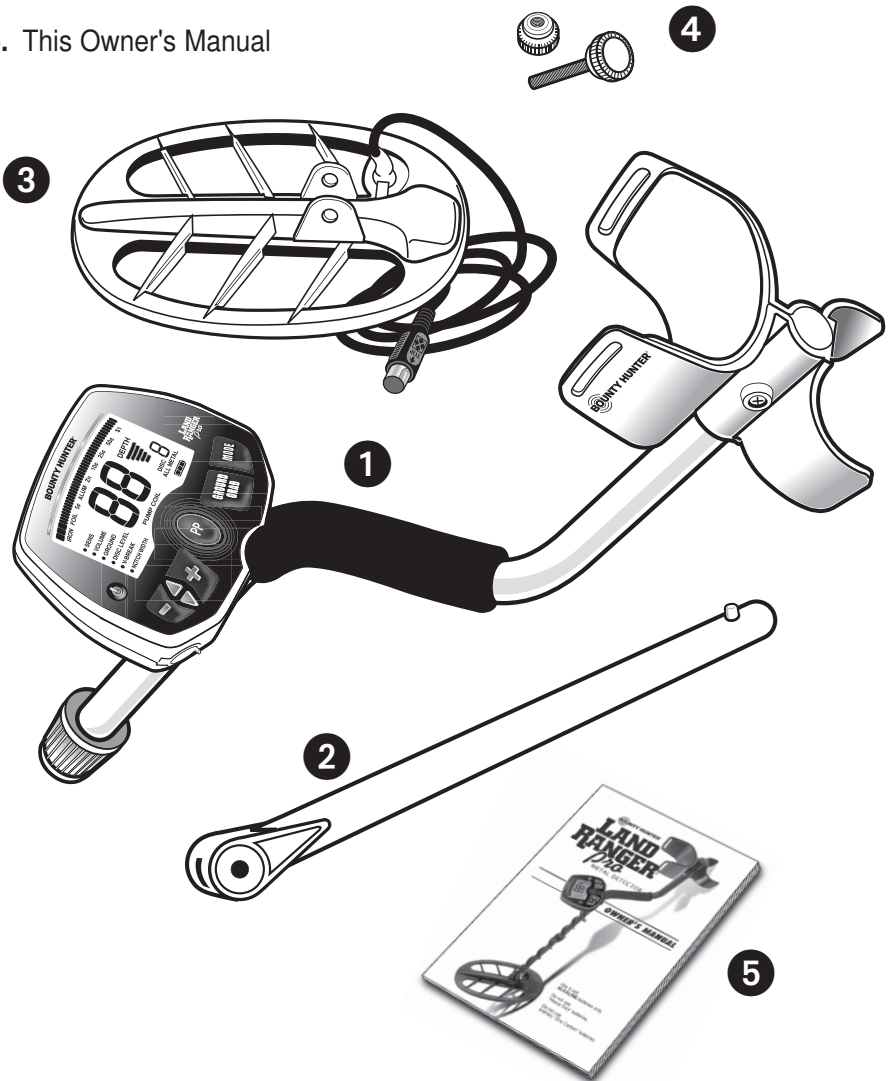

ASSEMBLING THE DETECTOR

- 1 Hold S-ROD upright.
- 2 Loosen LOCKING COLLAR on S-ROD; rotate counterclockwise.
- 3 Insert LOWER STEM into S-ROD with the SILVER BUTTON pointed upward.
- 4 Rotate the LOWER STEM until the SILVER BUTTON locates and clicks into a hole.

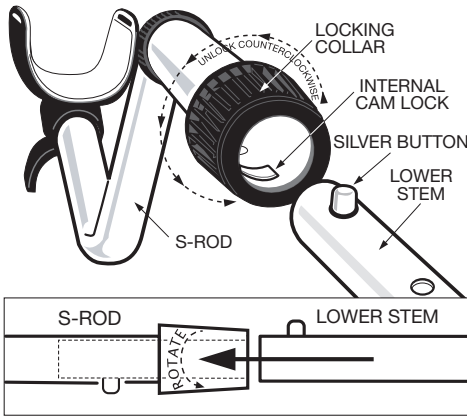

- 5 Attach the SEARCHCOIL to the LOWER STEM using the BOLT and KNURLED KNOB.
- 6 Adjust the LOWER STEM to a length that lets you maintain a comfortable upright posture while holding the detector relaxed at your side with the SEARCHCOIL parallel to the ground in front of you.
- 7 Wind the CABLE around the STEM. Leave slack in the cable at the bottom to allow the searchcoil to pivot.
- 8 Align the pins on the CABLE PLUG to the connector holes on the rear of the control housing.
- 9 Push in CABLE PLUG.
- 10 Twist the LOCKING COLLAR fully in the clockwise direction until stems are locked securely together.

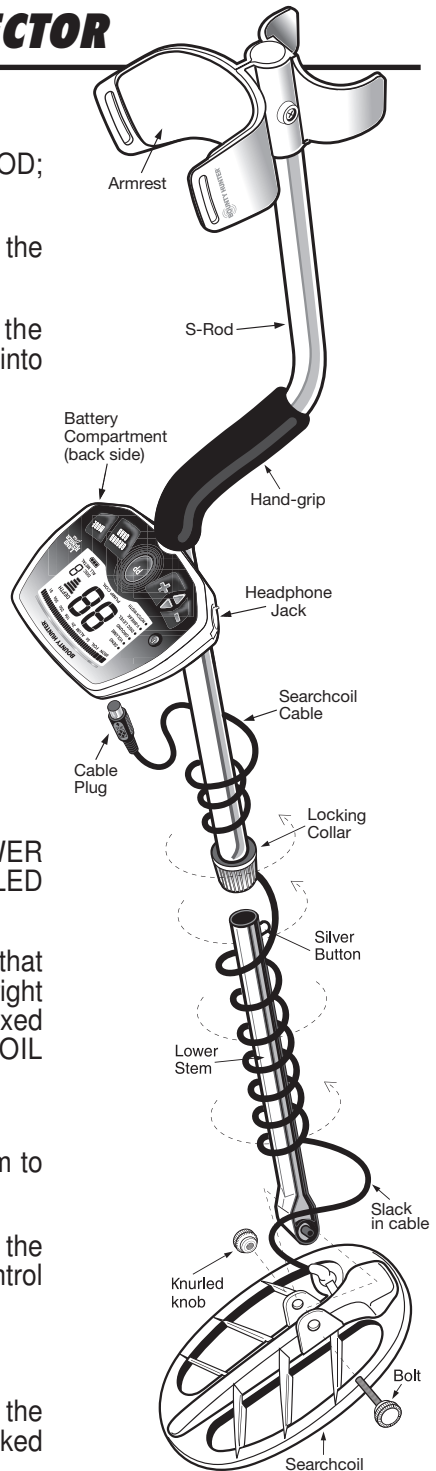

BATTERIES

The detector requires a single 9-volt **ALKALINE** battery (battery not included).

Do not use ordinary “Zinc Carbon” batteries

Do not use “Heavy Duty” batteries.

Rechargeable batteries can also be used. If you use rechargeables, we recommend using a “Nickel Metal Hydride” rechargeable battery.

The battery compartment is located on the back side of the Control Housing. Slide the battery door to the side to remove. Insert battery. Close battery door. When it's time to replace the battery simply push down firmly on the bottom of the battery (see illustration).

BATTERY LIFE

Expect 20 to 25 hours of life from a 9-volt alkaline battery.

Rechargeable batteries provide about 8 hours of usage per charge.

BATTERY INDICATOR

The battery icon has three segments plus an outline segment.

The amount of battery voltage for an ALKALINE battery is indicated as follows:

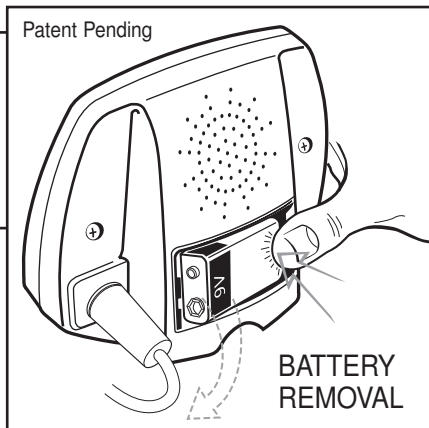

- | | |
|--------------------------|-------------------|
| 3 segments illuminated: | 8.1 volts or more |
| 2 segments illuminated: | 7.1 to 8.0 volts |
| 1 segment illuminated: | 6.5 to 7.0 volts |
| No segments illuminated: | 6.2 to 6.4 volts |
| Outline Flashing: | 6.1 or less |

SPEAKER VOLUME AND BATTERY CHARGE

You may notice the speaker volume drop while one battery segment is illuminated.

With the outline flashing, low speaker volume will be very apparent.

BATTERY DISPOSAL & RECYCLING



Alkaline batteries may be disposed of in a normal waste receptacle or recycled. Non-Alkaline batteries should be recycled. In the state of California all battery types must be recycled. Please refer to local municipalities for detailed disposal and recycling requirements.

QUICK-START DEMONSTRATION

I. Supplies Needed:

- a Nail (made of iron)
- a U.S. Nickel
- a U.S. Dime
- a U.S. Quarter (or silver coin)
- a Gold Ring
- a U.S. Penny, dated after 1982 (post-1982 pennies are made of Zinc)
(Most newer non-U.S. coinage also contains mostly Zinc)

II. Position the Detector:



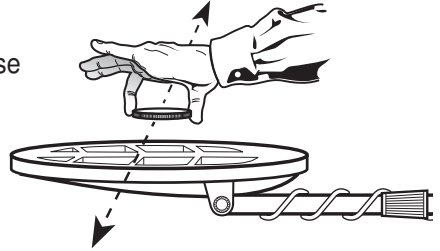

- a. Place the detector on a table with the searchcoil hanging over the edge. Or better, have a friend hold the detector with the searchcoil off the ground.
- b. Keep the searchcoil away from walls, floors and metal objects.
- c. Remove watches, rings and jewelry.
- d. Turn off lights or appliances whose electromagnetic emissions may cause interference.
- e. Pivot the searchcoil back.
- f. Reset detector to default settings: with detector OFF Press-and-Hold . Press .



III. Demonstrate COIN MODE:

- a. If display does not indicate **"DISC C"**, repeat step II.f. above. You are now in the preset Coin Mode.
- b. Wave objects over searchcoil. *Wave coins flat, parallel to searchcoil.* Notice the different sounds and 2-digit Target-IDs while you wave each object over the searchcoil:
 - High Tone: Dime, Quarter & Silver Coin
 - Medium Tone: Nickel, larger Gold Rings
 - Low Tone: Zinc Penny, smaller Gold RingsThe Nail will not be detected in COIN MODE.

IV. Demonstrate DISCRIMINATION MODE:

- (This demo uses the **DISC 2** Mode. There are other discrimination modes.)
- a. Push  until **DISC2** appears on lower right of the display.
 - b. Wave the nail; it is now detected. Notice the low tone.
 - c. Wave all other objects over searchcoil. They all induce the same sound, but have different Target-IDs. Notice V.C.O. change as objects move closer or farther from searchcoil.
 - d. Push  until "DISC LEVEL" is highlighted.
 - e. Push  until "19" is displayed.
 - f. Wave nail. It will not be detected because it has been "discriminated out."
 - g. Press  until "59" is displayed.
 - h. The Penny and Nickel will not be detected. They have now been "discriminated out."

V. Demonstrate PINPOINT FEATURE:

- a. Press and hold . "PP" momentarily appears on the screen
- b. Hold a coin motionless over the searchcoil.
- c. Lower coin toward searchcoil and then raise coin away from searchcoil.
- d. Notice that the sound changes as the coin moves closer and farther.
- e. Notice that the depth indicator changes as the coin moves up and down.

THE BASICS OF METAL DETECTING

This metal detector is intended for locating buried metal objects. When searching for metals, underground or on the surface, you have the following challenges and objectives:

1. Ignoring signals caused by ground minerals.
2. Ignoring signals caused by metal objects that you do not want to find, like nails.
3. Identifying a buried metal object before you dig it up.
4. Estimating the size and depth of objects, to facilitate digging them up.
5. Eliminating the effects of electromagnetic interference from other electronic devices.

Your metal detector is designed with these points in mind.

1. Ground Minerals

All soils contain minerals. Signals from ground minerals can interfere with the signals from metal objects you want to find. All soils differ, and can differ greatly, in the type and amount of ground minerals present. You therefore want to “calibrate” the detector to the specific ground conditions where you are hunting. The detector incorporates both automated and manual ground cancelation features which will eliminate false signals caused by most types of soils. If you want to maximize the detector's target identification accuracy and depth of detection, use the GROUND GRAB® Computerized Ground Cancelation function to calibrate the detector to the ground where you are searching. See the section on Ground Cancelation for details.

2. Trash

If searching for coins, you want to ignore items like aluminum foil and nails. You can see the Target-ID value of the buried objects, listen to the sounds and then decide what you want to dig up. Or you can eliminate unwanted metals from detection by using the DISCRIMINATION feature.

3. Identifying Buried Objects

Metal objects are identified by a 2-digit number on the display screen. This scale has 99 points of resolution, and is an indicator of the relative electrical conductivity of different objects. Higher numbers indicate more conductive targets. Iron objects, which are usually of lesser value, display lower numbers. Silver coins, for instance, usually display the highest numbers.

4. Size and Depth of Buried Objects

The 5-segment target depth indicator shows the relative depth of a buried metal object.

This bar graph can indicate the relative size of different objects or their distance from the searchcoil. For a given object, the more distance between it and the searchcoil, the more bars illuminated. A more accurate, and higher resolution, depth reading is available when using Pinpoint. Pinpoint does not require the searchcoil to be in motion to detect metals. The ability to hold the searchcoil motionless over the target also aids in tracing an outline of the buried object, or in pinpointing the exact location of the object using techniques described in the pinpointing section of this manual.

THE BASICS OF METAL DETECTING

5. EMI (Electromagnetic Interference)

The searchcoil produces a magnetic field and then detects changes in that magnetic field caused by the presence of metal objects. This magnetic field that the detector creates is also susceptible to the electromagnetic energy produced by other electronic devices. Cell phones, cell phone towers, power lines, microwave ovens, lighting fixtures, TVs, computers, motors, etc... all produce EMI which can interfere with the detector and cause it to beep when no metal is present, and sometimes to beep erratically.

The SENSITIVITY control lets you reduce the strength of this magnetic field, and therefore lessen its susceptibility to EMI. You may want to operate at maximum strength, but the presence of EMI may make this impossible, so if you experience erratic behavior or “false” signals, **reduce the sensitivity.**

USING THE DETECTOR

Sweep Method

Sweep the detector side-to-side over the ground.

Keep the searchcoil parallel to the ground as you sweep; do not lift the searchcoil at the ends of your sweeps.

Searchcoil motion is required for target detection (except when using Pinpoint).

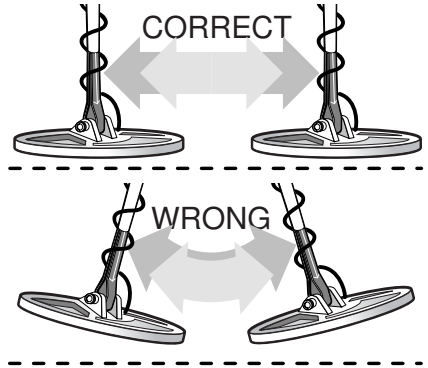

HOW TO WORK THE CONTROLS

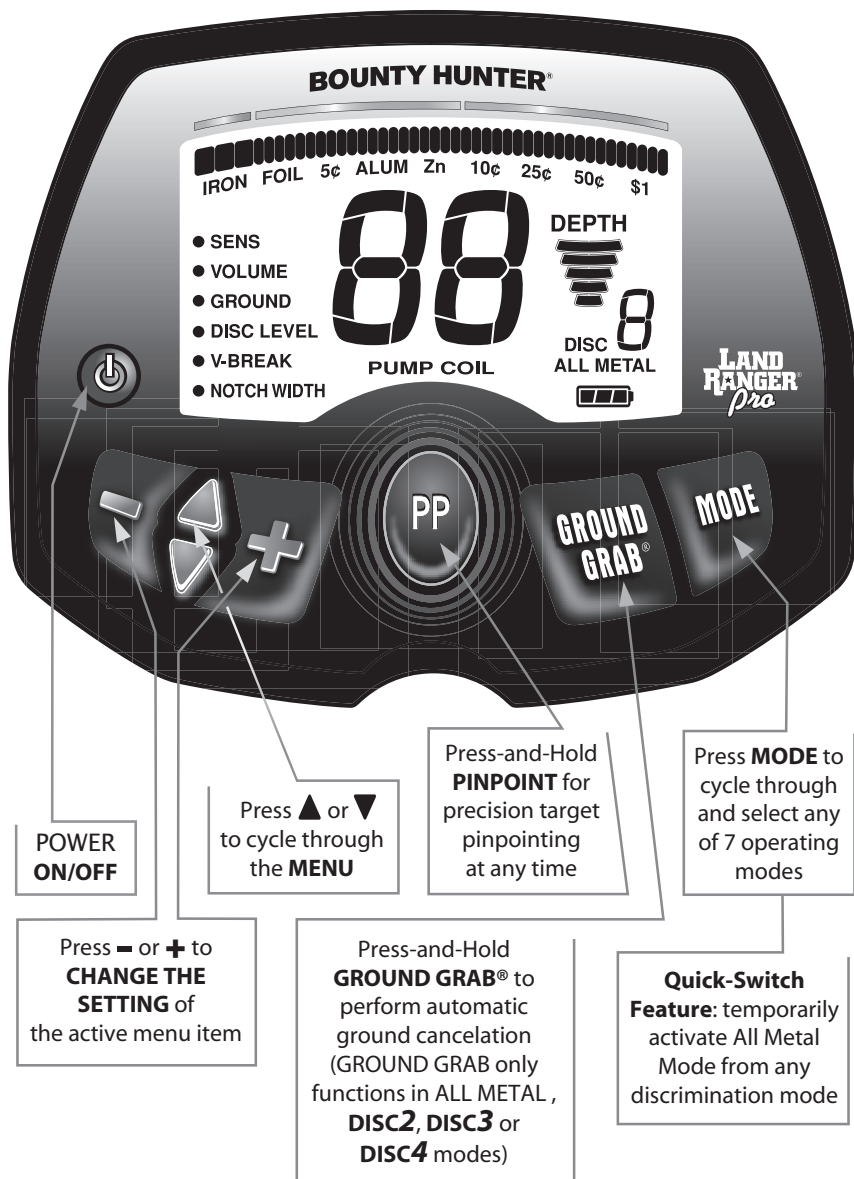

THE DISPLAY

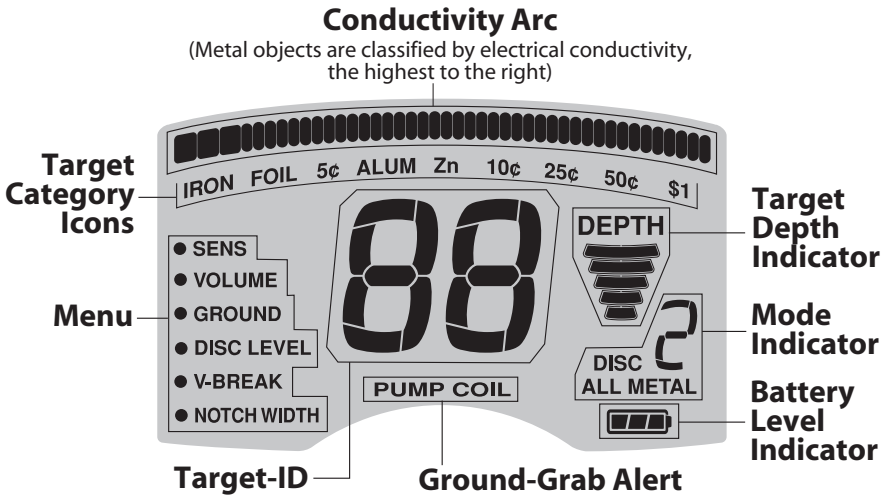

DEPTH INDICATOR

Coin-sized objects will be detected up to 10" deep.

The 5-segment graphic indicator is calibrated to coin-sized objects.

Coin on Surface

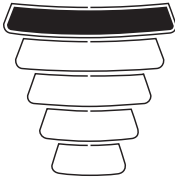

Coin is Shallow

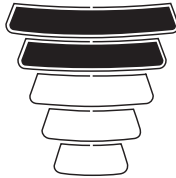

Coin is Very Deep



Objects other than coins will still register on the 5-segment depth scale, but the depth indication will be relative. For example, all 5 bars illuminated could indicate a coin buried 9" deep, but could also be a very large object several feet deep. Use the Depth Indicator in conjunction with the Target-ID system and the aid of Pinpoint to gain more information about a buried target.

OVERLOAD WARNING

If a metal object or highly magnetic soil are too close to the searchcoil, the detector will *overload* and "••" will appear on the screen. The detector will make a rapid, repeating mid-tone warning sound. Overload will not harm the detector, but the detector will not function under these conditions.

If *overload* occurs, raise the searchcoil to detect the target from a greater distance, or move to a different location.

TARGET IDENTIFICATION

Target-ID

When objects are detected, the detector will emit a sound and a 2-digit Target-ID will appear on the screen. Possible Target-IDs range from 1 to 99. This number represents the electrical conductivity of the target; higher numbers indicate more highly conductive targets.

The 2-digit number indicates the Target-ID of the last object detected. This detector has fast target response and is able to detect different objects in very close proximity. Therefore, the Target-ID displayed may change rapidly as you sweep the searchcoil.

Three seconds after the last Target-ID is displayed, the Target-ID will time-out and the number will disappear.

Conductivity Arc Indicator

At the same time that the 2-digit Target-ID appears, an indicator will illuminate along the Conductivity Arc indicating which target category the detected metal falls into. The illuminated segment along the Arc will time-out in 3 seconds along with the 2-digit Target-ID.

4-Tone Audio Target-ID

The detector will produce 1 of 4 sounds for any metal detected: V.C.O., low-tone, medium-tone or high-tone. This audio feedback system is useful in conjunction with the visual Target-ID system described above.

See chart below for description of tones induced by different metals in different modes:

Range -->	Iron-Range	Gold-Range				Silver-Range			
Category -->	IRON	FOIL	5¢	ALUM	Zn	10¢	25¢	50¢	\$1
Target-ID -->	1-19	20-29	30-39	40-49	50-59	60-69	70-79	80-89	90-99

MODE	TONES							
DISCC Coins	Not Detected		Medium	Not Detected	Low	High		
DISCJ Jewelry	Not Detected		Medium			High		
DISCA Artifacts	Not Detected	Low	Medium			High		
DISC2	Low		VCO					
DISC3	Low		VCO			High		
DISC4	Low	VCO	Medium	VCO	High			
ALL METAL	VCO							

All tones above assume V-BREAK at default setting. Any adjustment to V-BREAK will change some tones to LOW.

The faceplate label is color-coded above the Conductivity Arc. Ferrous, gold and silver targets will generally register within their corresponding color-coded ranges. Targets that are not gold or silver register within the same range according to their electrical conductivity.

Note that the electrical conductivity of a target depends on both its composition and size. Silver is more conductive than gold so registers farther to the right; and the larger the silver object, the farther it registers to the right.

OPERATION and CONTROL - an overview

MENU

The Menu is located on the left side of the screen. During normal operation the Menu is faded and inactive.

Use ▲ and ▼ to select a Menu option. Menu options are:

- Sens (Sensitivity)
- Volume
- Ground (Manual Ground Cancelation)
- Disc Level (Discrimination)
- V-Break® (Change audio for certain targets)
- Notch Width
- Notch

Use + and - to modify the setting of the selected Menu option.

Not all Menu options are available in all Modes.

MODES

The detector can be operated in any of 7 different modes. Each of these modes calibrates the operating parameters of the detector to different skill levels, applications or environments. Different Modes can be used for different detecting objectives and to best adapt to various ground and treasure conditions.

Push the MODE button to access any one of these:

- DISC C** (Coins)
- DISC J** (Jewelry)
- DISC A** (Artifacts)
- DISC 2** (2 tones)
- DISC 3** (3 tones)
- DISC 4** (4 tones)
- ALL METAL** (V.C.O.)

Settings Memory

When detector is powered off settings are saved, except for the ground setting.

How to reset to factory default setting (if desired)

- Power detector off.
- Press-and-Hold MODE.
- Press ⏻ while holding MODE down.
- The software version is indicated on the screen.
- Release MODE; detector turns on and all settings are restored to the factory defaults.

All Metal Quick-Switch

In any DISC Mode, press-and-hold MODE to temporarily activate the ALL METAL Mode.

Release MODE to return to DISC.

MENU

The Menu is located on the left side of the screen. During normal operation the Menu is inactive and faded.

Use ▲ and ▼ to select a Menu option. The option selected is marked by “●”. Once a menu option is selected, the setting can be changed using + and -. Not all options are available in all Modes. Here is a description of the Menu options:

SENS

Adjust the sensitivity from 1 to 10. The higher the number, the more sensitive the detector. This sensitivity control does not affect Pinpoint sensitivity.

If the detector beeps erratically or beeps when there are no metal objects being detected, **reduce the sensitivity**.

The searchcoil produces a magnetic field and then detects changes in that magnetic field caused by the presence of metal objects. This magnetic field that the detector creates is also susceptible to electromagnetic energy (EMI) produced by other electronic devices. Cell phones, cell phone towers, etc... all produce EMI which can interfere with the detector and cause it to beep when no metal is present, and sometimes to beep erratically.

VOLUME

Adjust speaker volume from 0 to 10. The Volume control changes the loudness of the audio when targets are detected, and also the loudness of the keypad presses and warning sounds.

GROUND

Adjust the Ground setting from 0 to 99. This provides for manual adjustment of the detector's internal ground setting, which you will usually want to set at the same value as soil's Ground Phase value.

See the Ground Cancellation section of the manual for an explanation of Ground Phase.

When adjusting the Ground setting manually, the Conductivity Arc across the top of the display graphically displays both the detector's internal ground setting and the actual phase of the ground.

- The black segment represents the detector's internal ground setting.
- The opposite end of the faded arc is the actual Phase of the soil.
- If only a black segment is displayed, with no faded segments, then the detector's ground setting is equal to the soil's Phase.

Note that when adjusting the Ground setting, the displayed setting changes by 1 number only after 10 keypad presses. The detector actually has 1,000 different ground settings to choose from, but uses only 2 digits to display the number. Reasons for this manual ground cancellation feature are explained in the Ground Cancellation section of the manual.

The Ground menu option is only available in the All Metal Mode. In all other modes, the Ground menu option will not appear on the screen.

MENU

GROUND (continued)

The Ground setting is the only user setting that is not saved when the detector is powered off.

The user's manual Ground setting carries over into the **DISC2**, **DISC3** and **DISC4** modes, but does NOT carry over into **DISCC**, **J** and **A** modes. In **DISCC**, **J** and **A** modes, the Ground setting is fixed at 82.

DISC LEVEL

Available settings from 0-59. All targets with IDs less than or equal to the Disc Level setting are eliminated from detection. For example, if Disc Level is set to 39, all targets with an ID of 39 or less will not be detected. By design, the detector does not allow highly conductive targets (like silver) to be discriminated out.

V-BREAK®

This is a feature that allows the user to change the audio response of certain targets. V-Break® allows the user to program the detector so that any target with an ID in the range of 0 - 69 can induce a LOW tone.

Examples:



The user sets V-Break® to a desired setting (e.g. 42).

Every target with ID less than or equal to 42 induces a low tone.

The audio response of targets with IDs greater than 42 is not changed.

V-Break® can be set only for Target-IDs that have not previously been rejected using the Discrimination or Notch functions.

NOTCH WIDTH

As you press  or  when adjusting the Notch Width setting, the blank area you see across the Conductivity Arc represents targets that will not be detected. This blank area is the "notch-window."

Notch Width allows you to set the size (or width) of this notch-window, which can be used to "notch out" or "notch in" targets from detection; the maximum width of the notch-window is 20.

NOTCH

After setting the width of the notch-window, it can be moved around using NOTCH. The setting you adjust corresponds to the left-most edge of the notch-window. It is not possible to move the window below 20; iron (IDs below 20) cannot be notched. If iron values are eliminated with Disc Level programming, they cannot be notched back in. Notch can be used in **DISC2**, **3** & **4** modes.

MENU

To best understand how to use the Menu features that control target detection and tone response, adjust each to any setting and observe how the Conductivity Arc behaves - watch how the bold segments, faded segments and blank segments interact.

Below are examples of possible programmed settings:



- 1 During operation, when a target is detected, the segment area representing the target is illuminated.

Example: detection of a U.S. Quarter
(the screen resets 3 seconds after target detection)



- 2 Using only DISC LEVEL control, pressing or will graphically illustrate targets being eliminated from left to right.

Example: Disc Level = 39



- 3 V-Break[®] changes segments from solid to faded (the faded segments represent low tones).

Example: Disc Level = 39 & V-Break[®] = 49

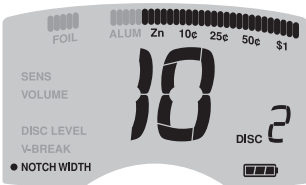

- 4 The Notch Width control can accept a range of targets previously rejected with the Disc Level control.

Example: Notch Width = 10

In this example, foil and aluminum are detected with low tones and targets from zinc and higher are detected with their default tones. Blank areas of the Arc are not detected.



- 5 Notch control moves the position of the notch-window across the Arc. As the window moves across the Arc, it inverts the detectability-status of the targets within the window.

Example1: Notch=34

Example2: Notch=50

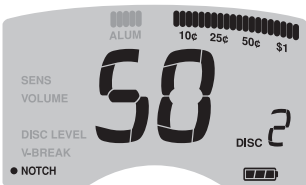

OPERATING MODES

DISC C

This preset mode is configured for coin-hunting. Iron, foil and aluminum are not detected.

Tones are: Low - zinc
Medium - U.S. Nickels
High - 10¢, 25¢, 50¢, \$1 and silver

Sensitivity and Volume settings can be adjusted. The Ground setting is preset to 82 and cannot be adjusted.

DISC J

This preset mode is configured for jewelry-hunting. Iron is not detected.

Tones are: Medium - most gold and small silver
High - silver

Sensitivity and Volume settings can be adjusted. The Ground setting is preset to 82 and cannot be adjusted.

DISC A

This preset mode is configured to hunt for artifacts.

Small iron objects are not detected.

Large iron objects are detected.

Tones are: Low - iron
Medium - foil, nickels, aluminum, zinc and most gold
High - copper and silver

Sensitivity and Volume settings can be adjusted. The Ground setting is preset to 82 and cannot be adjusted.

DISC 2, 3 and **4** can be used with the V-Break®, Disc Level, Notch and Ground controls. Select your preferred mode depending on the number of tones you want to hear.

DISC 2 (two tones)

Tones available are low and V.C.O. The V-Break® setting determines the range of Target-IDs that induce low tones. The factory default V-Break® setting is 19; unless adjusted, all iron will induce low tones.

DISC 3 (three tones)

This mode is the same as **DISC 2**, with the addition of a high tone for highly conductive targets.

DISC 4 (four tones)

This mode is the same as **DISC 2**, with the addition of a high tone for highly conductive targets and a medium tone for nickels.

ALL METAL

This mode does not allow for rejection of any targets. Many treasure hunters prefer All Metal when hunting ground with little trash metal present.

Audio is V.C.O. for all targets.

PINPOINT

Press-and-hold **PP** to activate the Pinpoint feature.

Searchcoil motion is not required; a motionless searchcoil over a metal target will induce sound.

Audio is V.C.O. The 2-digit number displayed indicates target depth, in inches. The scale is calibrated to coin-size objects.

After you have identified a target using a motion mode of detection, press-and-hold **PP** to identify the target's exact location. This technique can yield more information about the target's shape and size and also find its exact location to facilitate extraction.

Pinpoint as follows:

1. Press and hold **PP**
2. Position the searchcoil just barely off the ground, and to the side of the target.
3. Now move the searchcoil slowly across the target, and you can locate it by the sound.
The target is located directly under where the sound is loudest.

Narrow It Down:

1. To narrow the response further, position the center of the searchcoil near the center of the response pattern, but not directly over the center.
2. Release **PP**.
3. Immediately press-and-hold **PP** again.
4. Repeat this narrowing procedure to narrow the field of detection further.

Note: Depth indication is less accurate after narrowing.

COIL DRIFT

If you plan to use PINPOINT for continuous searching, realize that drift will occur over time, causing the detector to gain or lose sensitivity. Periodic retuning of the detector is required to minimize drift; release and press **PP** periodically to retune.

Pinpointing using motion modes (without **PP):**

1. Sweep over target in narrowing side-to-side patterns.
2. Take note of the spot on the ground where "beep" occurs.
3. Step 90° to the side of the target.
4. Sweep searchcoil over same area, at 90° to the 1st sweep pattern.
5. This pinpoints the target location with an "X".

GROUND CANCELATION

WHAT IS GROUND CANCELATION?

Why do I need to cancel out the ground?

All soils contain minerals. Signals from ground minerals are often tens or hundreds of times as strong as the signal from a buried metal object. The magnetism of iron minerals, found in nearly all soils, causes one type of interfering signal. Dissolved mineral salts, found in some soils, are electrically conductive, causing another type of interfering signal.

Ground Cancellation is the process by which the metal detector cancels the unwanted signals coming from the ground minerals while still detecting the signals from buried metal objects. This is accomplished by matching the detector's Ground setting to the Phase of the ground signal.

When the detector is calibrated to the soil, the result will be *deeper target detection, quieter operation and more accurate target identification.*



The most accurate GROUND value is the value displayed when “pumping” the searchcoil over the ground in an area free of metal.

Ground Grab® Computerized Ground Cancellation:

This control allows you to set the detector's internal ground setting equal to the Phase of the ground you are searching over.

Press-and-hold  to invoke automatic ground cancellation. This will “grab” the ground value and store it in the detector.

In order to calibrate the detector to the most accurate ground value, **pump the searchcoil up and down** over the ground while standing in one place over a patch of ground free of metal.

1. Press-and-hold 
2. The display will indicate “Pump Coil.”
3. Start with searchcoil 6” above the ground; lower it to about 1” from the ground.
4. Continue the pumping motion until the 2-digit number stabilizes and no faded segments are visible on the Conductivity Arc.
5. At the point where the 2-digit number stops changing, the detector has correctly measured the ground Phase.
6. Immediately release  to set the detector's internal ground setting equal to the last value displayed.

During GROUND GRAB, the detector jumps into ALL METAL operation. The sound you hear is the sound of the ground.

Ground Grab cannot be invoked from DISC **C**, **J** or **A**.

GROUND BALANCING

MANUAL GROUND ADJUSTMENT

Refer to the **GROUND** section of the manual for instructions on how to manually adjust the detector's internal Ground setting.

If the Ground setting is incorrect, there will be a difference in the sound as the searchcoil is either moving toward or away from the ground. It sounds like you are either ***pulling the sound out of the ground***, or ***pushing the sound into the ground***.

- If the sound gets louder as you raise the searchcoil, increase the Ground setting.
- If the sound gets louder as you lower the searchcoil, reduce the Ground setting.

NOTE: Experienced users often prefer to adjust the Ground setting to get a weak but audible response when lowering the searchcoil. This is called "adjusting for positive response."

HEADPHONE JACK

Push the tab up and lock into place to expose the headphone jack.

This detector has a 1/4" headphone jack. It works with any stereo headphone that has a 1/4" plug.

When the headphone jack is connected, speaker volume is disabled.

USING HEADPHONES

Using a detector with headphones facilitates detection of the weakest signals and also extends battery life.

It also allows you to hear subtle changes in the sound more clearly, particularly if searching in a noisy location. For safety reasons, do not use headphones near traffic or where other dangers are present. This device is to be used with interconnecting cables/headphone cables shorter than three meters.

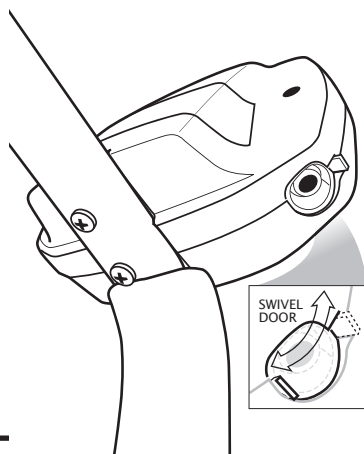

DEPTH AND TARGET DISPLAY

Please refer to the display on your detector and reference the TARGET-ID categories below applicable to your model (not all detectors include all of these categories).

READING THE DISPLAY

The display shows the PROBABLE identification of the metal detected, as well its PROBABLE depth.

The detector will register a target identification, upon each sweep of the searchcoil, when a buried target has been located and identified. If, upon repeated passes over the same spot, the target identification reads inconsistently, the target is probably a trash item. With practice, you will learn to unearth only the repeatable signals.

The segment identifications are highly accurate, when detecting the objects described on the faceplate. However, if an object registers in a given category for an unknown buried object, you could be detecting a metallic object other than the object described on the faceplate, but with the same metallic signature. Also, the greater the distance between the target and the searchcoil, the less accurate the target identification.

GOLD TARGETS Gold objects will generally register toward the middle or left-of-center on the scale.

Gold flakes will register under iron.

Small gold items will register under foil or 5¢.

Large gold items will register toward the center of the scale.

SILVER TARGETS: Silver objects will register to the right of the scale, under dime or higher.

IRON: All sizes of iron objects will register on the far-left side of the scale. This could indicate a worthless item such

as a nail, or a more valuable historic iron relic.

FOIL: Aluminum foil, such as a gum wrapper, will register as foil. A small broken piece of pull tab may also register here.

5¢: Most newer pull-tabs from beverage cans, the type intended to stay attached to the can, will register here. Many gold rings will also register here.

ALUM: Older pull-tabs, which always detached completely from the can, register here. Many medium-sized gold rings also register here.

PT (pull-tabs): Pull-tabs from older beverage cans will register here. Few newer pull-tabs will also register here. Many gold rings will also register here.

S-CAP: Older screw caps from glass bottles will register here. Large gold rings, like a class ring, could also register here. Some non-U.S. coins of recent vintage will also register here.

Zinc: Medium conductivity objects and many non-U.S. coins of recent vintage are classified here.

The Target Identification Categories to the right of the display, such as 10¢, DIME, 25¢, Quarter, 50¢ and \$1 accurately identify these U.S. coins. When used in areas outside the U.S., these categories identify coins or metal objects of high relative conductivity (such as silver coins or relics), or large objects made of any type of metal.

Caution: The target indications are visual references. Many other types of metal can fall under any one of these categories. While the detector will eliminate or indicate the presence of most common trash items, it is impossible to accurately classify ALL buried objects.

TROUBLESHOOTING GUIDE

SYMPTOM	CAUSE	SOLUTION
Detector chatters, beeps erratically or has low sensitivity	<ul style="list-style-type: none"> • Using detector indoors • Using detector near power lines • Using 2 detectors in close proximity • Environmental electromagnetic interference 	<ul style="list-style-type: none"> • Use detector outdoors only • Move away from power lines • Keep 2 detectors at least 6 meters (20') apart • Reduce sensitivity until erratic signals cease
<p>Do not mix old and new batteries. Use alkaline batteries. Do not mix alkaline, standard (zinc-carbon), or rechargeable (NiCad, NiMH, etc.) batteries.</p>		
Low speaker volume	<ul style="list-style-type: none"> • Discharged battery • Wrong type of battery 	<ul style="list-style-type: none"> • Replace battery • Use alkaline batteries
Display does not lock on to one Target-ID or detector emits multiple tones	<ul style="list-style-type: none"> • Multiple targets present • Highly mineralized soil • Sensitivity set too high 	<ul style="list-style-type: none"> • Sweep coil at different angles • Cancel Ground (if your detector provides operator-control) • Reduce sensitivity
No power, no sounds	<ul style="list-style-type: none"> • Dead battery • Cable not connected securely 	<ul style="list-style-type: none"> • Replace batteries • Check connections

Note: This equipment has been tested and found to comply with the limits for a Class B digital device, pursuant to part 15 of the FCC Rules. These limits are designed to provide reasonable protection against harmful interference in a residential installation. This equipment generates, uses and can radiate radio frequency energy and, if not installed and used in accordance with the instructions, may cause harmful interference to radio communications. However, there is no guarantee that interference will not occur in a particular installation. If this equipment does cause harmful interference to radio or television reception, which can be determined by turning the equipment off and on, the user is encouraged to try to correct the interference by one or more of the following measures:

- Reorient or relocate the receiving antenna.
- Increase the separation between the equipment and receiver.
- Consult the dealer or an experienced radio/TV technician for help.

CE The manufacturer declares that the minimum ESD performance criteria is 1) the unit shall not be permanently damaged and 2) operator intervention is allowed.

This product is RoHS compliant.

This product meets the requirements of Industry Canada: CAN ICES-3 B/NMB-3 B.

TREASURE HUNTER'S CODE OF ETHICS:

- Always check Federal, State, County and local laws before searching.
- Respect private property and do not enter private property without the owner's permission.
- Take care to refill all holes and leave no damage.
- Remove and dispose of any and all trash and litter found.
- Appreciate and protect our inheritance of natural resources, wildlife and private property.
- Act as an ambassador for all treasure hunters; use thoughtfulness, consideration and courtesy at all times.
- Never destroy historical or archaeological treasures.
- All treasure hunters may be judged by the example you set; always conduct yourself with courtesy and consideration of others.



ACCESSORIES

Bounty Hunter® Carry Bag

Rugged double-stitched construction. – *CBAG2*

Bounty Hunter® Pouch & Digger Combo

Pouch with 2 large pockets & 9" heavy duty digging tool. – *TP-KIT-W*

Pinpointer

Pinpoints the exact location of buried metal objects. Audio signal indicator and vibrator. Runs on (1) 9-Volt Alkaline battery. – *PIN POINTER-W*

Bounty Hunter® Sand Scoop

Large scoop with filtering holes. Made of strong plastic. – *SAND SCOOPBH*

Replacement/Accessory Searchcoils

4" Concentric Round – *4COILPRO*

8" Concentric Open Face – *8COIL-7B13*

10" Concentric – *10COIL-BH*

11" Biaxial Replacement – *11COIL-BH*

Searchcoil Covers

Protect your searchcoil from abrasion and damage.

4" Concentric, Round Cover – *4COVER*

8" Concentric Open Face Cover – *8COVER-7*

10" Concentric Cover – *F70COVER*

11" Biaxial Cover – *COVER-11DD*

9" Heavy-Duty Digging Tool

Metal blade with comfortable plastic handle and depth gauge. – *TROWEL-2*

Digging Tool

Light and practical plastic, wide blade digging tool. – *TROWEL-W*

Rain Cover

Custom made to protect from weather. – *RAINCOV-ET*

Bounty Hunter® Baseball Cap

One size fits all, with Bounty Hunter® logo. – *BHCAP*

Bounty Hunter® T-Shirt

100% cotton with Bounty Hunter® Logo.

Sizes: S, M, LG, XL & XXL – *BHTSHIRT*

Gold Prospecting Kits

Items Included:

	Gold Kit PART NUMBER: GOLDKIT1	Deluxe Kit PART NUMBER: GOLDKIT2	Hardrock Kit PART NUMBER: GOLDKIT3
10 1/2" Gold Pan	x	x	x
14" Gold Pan	x	x	x
Classifier		x	x
2 – Shatterproof Vials	x	x	x
Snuffer Bottle	x	x	x
Black Sand Magnet		x	x
Treasure Scoop		x	x
Tweezers			x
Magnifier			x
Crevice Tool			x
Rock Pick			x
Instruction Booklet	x	x	x
Backpack		x	x

