

Owner's Manual & Assembly Instructions

Shelf Bracket Kit Model No. SS404



65103
#8-32 Hex Nut (12)



65923
#8-32x3/8" Bolt (12)

● **ANY STANDARD ARROW STORAGE BUILDING**
Install 2 **posts** at desired location in the building by removing 2 fasteners in the framework. Interlock the 2 posts and telescope them to the proper length between the upper and mid wall frames, or mid wall and floor frames. Tabs on ends of posts go behind frames. Reinsert top and bottom fasteners. Fasten posts together using a bolt and nut at the center of posts. Install the next 2 posts at the other end of shelf location by removing 2 fasteners as before. Install **shelf brackets** to posts using 2 bolts and nuts. Use same set of holes on each post so that shelf is level. Fasten shelf to bracket using wood screws (not included).
FOR BUILDINGS WITH NO MID WALL FRAME:
Install posts in the same manner. Using hole in bottom tab on post as a guide, drill 1/4" dia. hole through side wall panel and fasten with a bolt and nut.

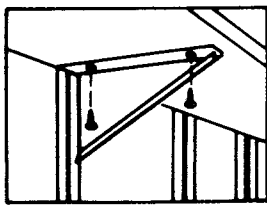
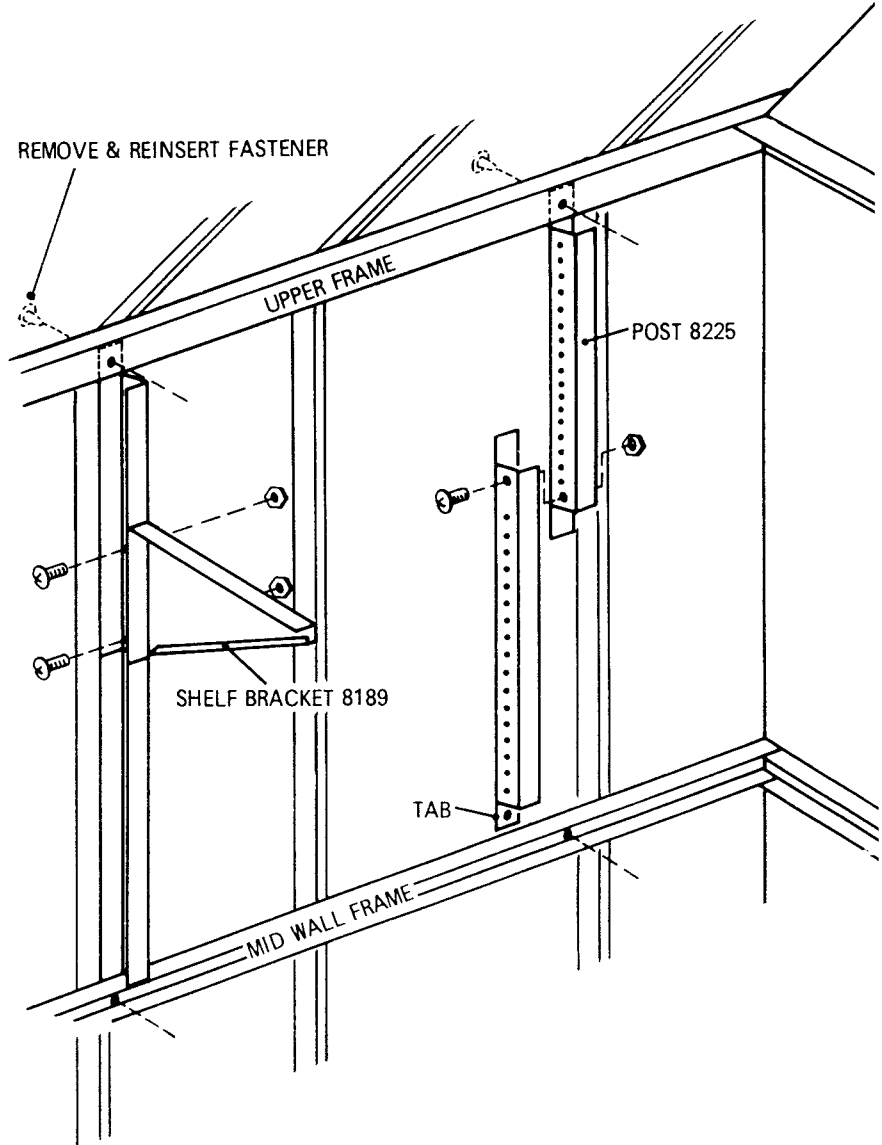

FASTEN SHELF TO BRACKET

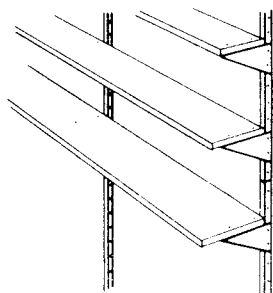

COMPLETED SHELF

VARIOUS LOCATIONS OF SHELVING SYSTEMS

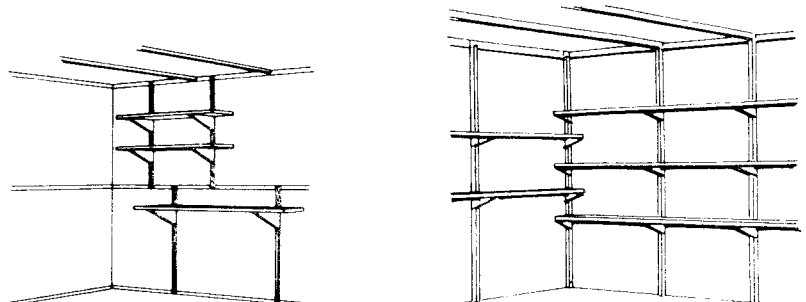

CAUTION: SOME PARTS HAVE SHARP EDGES. CARE MUST BE TAKEN WHEN HANDLING THE VARIOUS PIECES TO AVOID A MISHAP. FOR SAFETY SAKE, WEAR GLOVES WHEN HANDLING METAL PARTS.

● **YARDSAVER OR ANY SIDING BUILDING**

Fasten **shelf bracket** directly to siding studs using 2 bolts and nuts. Install **posts** horizontally between studs for mounting pegboard or use hooks for hanging tools (not included).

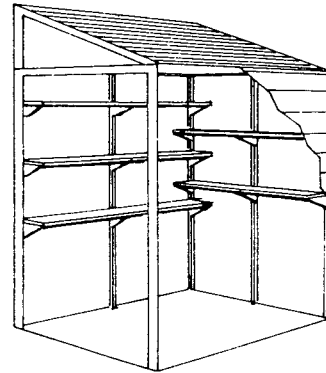
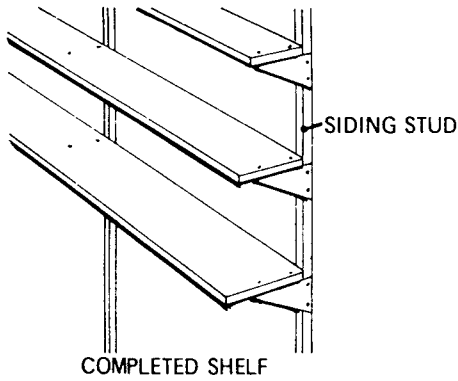

VARIOUS LOCATIONS OF SHELVING SYSTEMS

FOR BUILDINGS WITH NO MID WALL FRAME:

Telescope posts to line up tab on bottom post with flat spot in siding panel. Fasten posts together with a bolt and nut. Using hole in bottom tab as a guide, drill 1/4" dia. hole through siding panel and fasten using a bolt and nut.

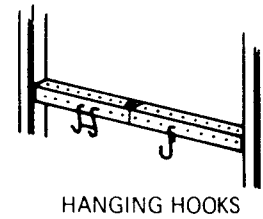
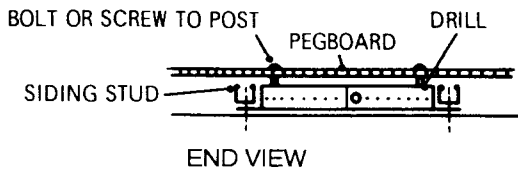
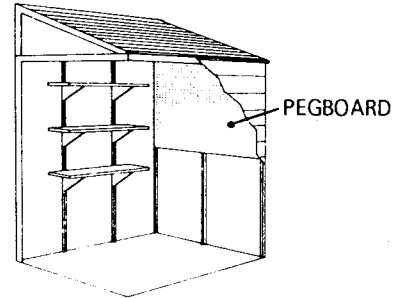

● **GARAGE** ● **BASEMENT** ● **WORKSHOP**

Locate studs behind sheetrock. Install **posts** directly to studs by making a pilot hole and using #10 wood screws (not included). **Shelf brackets** can also be fastened directly to exposed wall studs using #10 wood screws (not included).

