

HD004 | 10" Heavy Duty Aluminum C-Clamp Mounting Pedestal

1 Place the Mount

Open the C-clamp on the bottom of the mount by turning the clamp knob counter clockwise. Tighten the clamp knob to secure on mounting area.

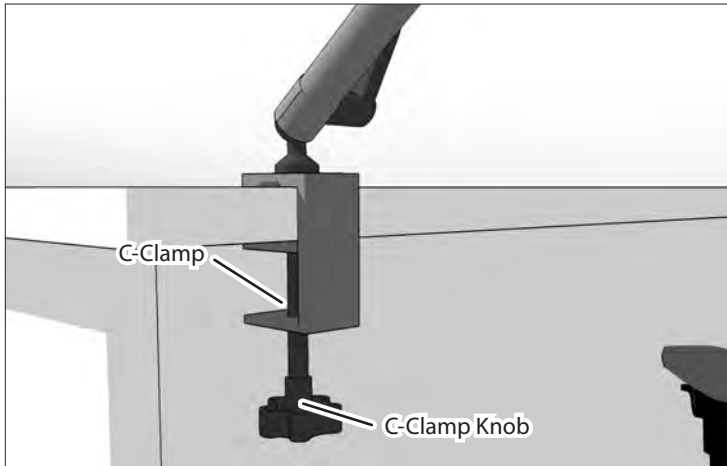

Package Contents:

(1) HD004 - 10" Heavy Duty Aluminum C-Clamp Mount



2 Attach the Holder (sold separately)

Attach a holder (sold separately) to the C-clamp mount by inserting the Dual-T tabs into the holder and sliding the holder down to lock.

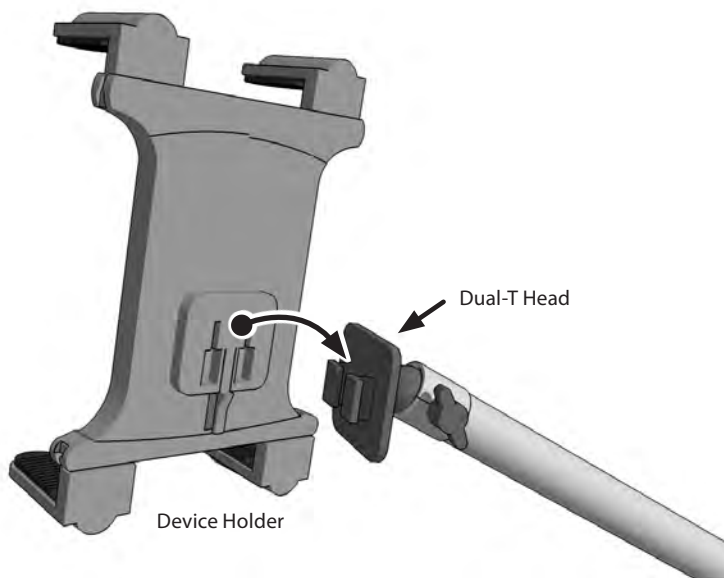

3 Adjust the Mount

Adjust the C-clamp mount position by loosening the joint adjustment knobs and retightening in the desired position.

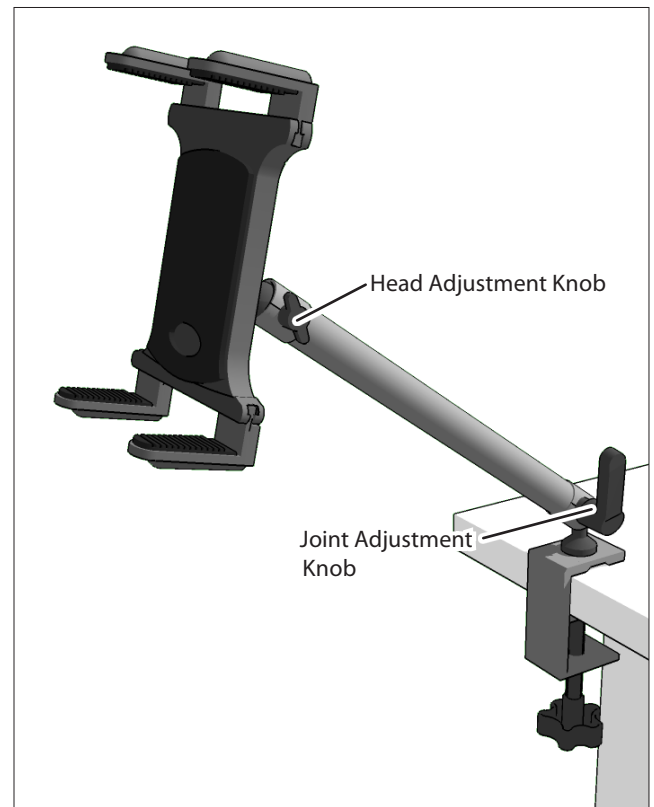

Safety Precautions

Do not install Arkon products over an air bag cover or within the air bag deployment zone. Arkon Resources, Inc. assumes no responsibility of liability for injury or death as a result of car crashes and/or air bag deployment.

Arkon is not responsible for any damages caused to your car, your device, or yourself due to the installation or use of this pedestal mount.

Rev. 12911

ARKON
RESOURCES INC. The Mobile Mounting Specialists™