



# 2022 PRODUCT CATALOG





In a particularly stormy fall of 1970, our owner embarked on a journey to make the best gun cases your hard-earned money could buy. Today, ALLEN Company still operating under the same family ownership, has expanded from gun cases into other outdoor product categories like; Shooting Essentials, Tactical Gear, Hunting and Archery Accessories. A lot has changed as we celebrate our 50th anniversary, but what hasn't changed is the pride of being a Colorado company dedicated to preserving product value and promoting the Heritage of these Outdoor Activities our customers so passionately enjoy.

**We thank you for your role in this American Pioneering Story.**

**ALLEN Company - family owned since 1970**

## WE'VE MOVED TO OUR BRAND NEW HEADQUARTERS IN LOUISVILLE, COLORADO



**1970**

**THE BEGINNING**



ALLEN Company was founded in April of this year and began immediately making first gun case production in a shared warehouse serving as the original headquarters.

**1978**

**DETERMINATION**



Due to increasing customer demand, headquarters of the company were moved from the original location to a new building 20,000 sq. ft. in size. In order to meet growing demand the owner sometimes slept on a fabric cutting table—just to make sure orders were manufactured and shipped on time to customers.

**1986**

**NEW CATEGORIES**



Due to demand, it was time to move again. As a result, the company made a long-standing move to 525 Burbank St. into a new building that was 90,000 sq. ft. in size. This building served as the corporate headquarters for the single longest period of time and saw the proliferation into many categories like; shooting accessories, tactical gear, eye/ear protection and rifle slings.

**2013**

**GROWTH**



In parallel with the overall market surge, this year marked a record for the highest unit production of cases that the company had ever produced in the domestic USA manufacturing operation. This record was achieved by the accumulation of total long gun, handgun, tactical, bow case, gun socks/gun sleeves and OEM-based business.

**2020**

**50TH ANNIVERSARY**



ALLEN Company celebrates their 50th anniversary of being in business and opens a new state of the art manufacturing facility and headquarters in Louisville, CO. This venture cements the company's future leading the outdoor industry with products that blend hard-earned value with visionary product design.



## GUN STORAGE

2 - 43

<b>GUN CASES</b>	2 - 15
<b>GUN POUCHES &amp; SOCKS</b>	16 - 19
<b>ATTACHE CASES</b>	20 - 21
<b>HANDGUN CASES</b>	22 - 23
<b>CONCEAL CARRY PURSES</b>	24 - 25

<b>HOLSTERS</b>	26 - 29
<b>MAGNETIC GUN MOUNTS</b>	30 - 31
<b>GUN RACKS &amp; HOLDERS</b>	32 - 33
<b>AMMO POUCHES</b>	34 - 35
<b>SLINGS &amp; SWIVELS</b>	36 - 43



## TARGETS

44 - 61

<b>TARGET RACKS &amp; PADS</b>	44 - 45
<b>PULL-N-SHOOT TARGETS</b>	46
<b>REFLECTIVE TARGETS</b>	46
<b>TARGET KITS</b>	47
<b>ADHESIVE SPLASH</b>	48 - 51

<b>SPLASH REACTIVE PAPER TARGETS</b>	52 - 53
<b>TARGET STANDS</b>	54 - 55
<b>AR500 &amp; STEEL</b>	56 - 57
<b>SELF-HEALING &amp; CLAY</b>	58 - 60
	61



## SHOOTING

62 - 87

<b>RANGE BAGS</b>	62 - 63
<b>SHELL &amp; CHOKE CARRIERS</b>	64 - 65
<b>BIPODS, LOCKS &amp; ACC.</b>	66 - 67
<b>SHOOTING BAGS &amp; RESTS</b>	67 - 71

<b>SHOOTING STICKS</b>	72 - 75
<b>EYE &amp; EAR PROTECTION</b>	76 - 81
<b>KROME™ CLEANING KITS</b>	82 - 84
<b>GUN CLEANING</b>	85 - 87



## TACTICAL

88 - 105

<b>GUN CASES</b>	88 - 97
<b>PISTOL CASES &amp; POUCHES</b>	98 - 99

<b>PACKS &amp; BAGS</b>	100 - 103
<b>RANGE BAG &amp; SLINGS</b>	104 - 105



## RUGER®

106 - 115

<b>TACTICAL CASES &amp; PACKS</b>	106 - 107
<b>GUN CASES</b>	108 - 109
<b>HANDGUN CASES</b>	110

<b>GUN SOCKS &amp; POUCHES</b>	111
<b>SLINGS &amp; TARGETS</b>	112 - 113
<b>EYE/EAR &amp; CLEANING</b>	114 - 115



## GIRLS WITH GUNS®

116 - 125

<b>GUN CASES &amp; POUCHES</b>	116 - 117
<b>CONCEAL CARRY PURSES</b>	118 - 119

<b>SLINGS &amp; TARGETS</b>	120 - 123
<b>EYE/EAR &amp; BAGS</b>	124 - 125



## HUNTING/PACKS

126 - 143

<b>VANISH™</b>	126 - 131
<b>SHOCKER™</b>	132 - 133
<b>PUNISHER™ &amp; WATERFOWL</b>	134

<b>BRUISER™</b>	135
<b>TERRAIN™</b>	136 - 139
<b>ALLEN HUNTING</b>	140 - 143



## CROSSBOW/ARCHERY

144 - 153

<b>TITAN™</b>	144 - 148
<b>FIELD TIPS</b>	148
<b>STRYKE™ &amp; VELOX™</b>	149

<b>RAZOR™</b>	150
<b>K'NETIX</b>	151
<b>PULSE</b>	152 - 153



## FISHING

154 - 163

<b>BACK &amp; CHEST PACKS</b>	154 - 155
<b>PACKS &amp; VESTS</b>	156 - 157

<b>ROD CASES &amp; GEAR BAGS</b>	158 - 159
<b>WADERS, BOOTS &amp; BAGS</b>	160 - 163



**NORTH PLATTE  
HERITAGE GUN CASES**

- 12oz COTTON CANVAS QUILTED MATERIAL WITH SPLIT LEATHER TRIM
- ROLLED HANDLES
- METAL ZIPPER AND HARDWARE
- PLUSH TRICOT LINING

OLIVE, RIFLE, 48<sup>in</sup>  
**541-48 \ 4PK \ 026509035909**

OLIVE, SHOTGUN, 52<sup>in</sup>  
**543-52 \ 4PK \ 026509035923**



SEE OUR OTHER HERITAGE ACCESSORIES:

HERITAGE  
ATTACHE  
P. 21



HERITAGE  
SLING  
P. 36



HERITAGE  
RANGEBAG  
P. 62



HERITAGE  
DUFFEL  
P. 139



**LAKWOOD  
HERITAGE GUN CASES**

- THICK PADDING KEEPS YOUR GUN PROTECTED
- CONVENIENT CARRY HANDLES
- LOCKABLE

BUFFALO PLAID, RIFLE, 46<sup>in</sup>  
**707-46 \ 4PK \ 026509045021**  
BUFFALO PLAID, SHOTGUN, 52<sup>in</sup>  
**707-52 \ 4PK \ 026509040934**





# GUN CASES



## GEAR FIT<sup>®</sup> MAG

### GEAR FIT<sup>®</sup> MAG RIFLE CASE: 50IN

- AMPLE STORAGE POCKETS
- END POCKET WITH MAGNETIC FLAP CLOSURE
- MIXED MATERIALS PROVIDE EXTRA DURABILITY
- PLUSH FLEECE LINING

BLACK\GRAY\RED  
547-50 \ 4PK \ 026509043577



## GEAR FIT<sup>®</sup> MOA

### GEAR FIT<sup>®</sup> MOA RIFLE CASE: 55IN

- LONGER LENGTH FOR MODERN SPORTING RIFLES
- POCKETS AND PANELS STORAGE
- HEAVY-DUTY FOAM FOR ADDED PROTECTION
- LOCKABLE

BLACK\GRAY  
545-55 \ 4PK \ 026509043546

PATENT  
PENDING



## GEAR FIT

### DAKOTA GEAR FIT<sup>®</sup> RIFLE CASE: 48IN

- GEAR FIT<sup>®</sup> STORAGE FLAPS FOR OVERSIZED GEAR
- CLEAR POCKET PANELS TO SEE CONTENTS
- LOCKABLE\RUBBER ZIPPER PULLS
- DUAL-LAYER FOAM TO PROTECT CONTENTS

BLACK\GRAY\RED  
949-48 \ 4PK \ 026509026839



## GEAR FIT

### DAKOTA CXE GEAR FIT<sup>®</sup> RIFLE CASE: 48IN

RT XTRA, 48IN X 10IN  
959-48 \ 4 PK \ 026509026846



## GEAR FIT

### BONANZA GEAR FIT<sup>®</sup> RIFLE CASES: 48IN

- GEAR FIT<sup>®</sup> STORAGE FLAPS FOR OVERSIZED GEAR
- RUGGED ENDURA FABRIC
- LOCKABLE ZIPPERS

GRAY\ORANGE  
919-48 \ 4 PK \ 026509010876  
MO BU COUNTRY  
917-48 \ 4 PK \ 026509917489



**GEAR FIT  
PURSUIT™**



PATENT PENDING

\*ACCESSORIES SHOWN NOT INCLUDED

**NEW**

**2.0 GEAR FIT PURSUIT™ SHOCKER™ TURKEY SHOTGUN CASE: 52IN**

- HEAVY-DUTY DUAL-DENSITY FOAM FOR ULTIMATE PROTECTION
- LOCKABLE

MO OBSESSION NWT F

961-52 \ 4 PK \ 026509064664

**TURKEY SPECIFIC POCKETS**

- |                            |   |
|----------------------------|---|
| 1. CHOKE TUBE STORAGE      | 6. SHOOTING STICK/ACCESSORIES HOLDING FLAP      |
| 2. MOUTH CALL STORAGE      | 7. REMOVABLE TAPE FOR MEASURING SPURS AND BEARD |
| 3. BOX CALL STORAGE        |   |
| 4. STRIKER & SLATE STORAGE |   |
| 5. AMMO STORAGE            |   |



PATENTED  
#US D850,788 S

\*ACCESSORIES SHOWN NOT INCLUDED

**GEAR FIT PURSUIT™ SHOCKER™ TURKEY SHOTGUN CASE: 52IN**

- HEAVY-DUTY DUAL-DENSITY FOAM FOR ULTIMATE PROTECTION
- EASY CLEAN LINER
- LOCKABLE

MO OBSESSION NWT F

954-52 \ 4 PK \ 026509020417

**TURKEY SPECIFIC POCKETS**

- |                       |   |
|-----------------------|---|
| 1. CHOKE TUBE STORAGE | 5. SLATE CALL STORAGE                           |
| 2. MOUTH CALL STORAGE | 6. REMOVABLE TAPE FOR MEASURING SPURS AND BEARD |
| 3. BOX CALL STORAGE   |   |
| 4. STRIKER STORAGE    |   |



\*ACCESSORIES SHOWN NOT INCLUDED

**GEAR FIT PURSUIT™ BULL STALKER™ RIFLE CASE: 48IN**

- HEAVY-DUTY DUAL-DENSITY FOAM
- FITS SCOPED RIFLES UP TO 48IN (121CM)
- LOCKABLE

MO MOUNTAIN COUNTRY

921-48 \ 4 PK \ 026509026822

**ELK SPECIFIC POCKETS**

- |  |   |
|--|---|
| 1. AMMO POCKET                         | 4. GEAR FIT® STORAGE FLAP FOR LARGE ACCESSORIES |
| 2. SCENT SPRAY POCKET                  | 5. MULTIPLE ACCESSORY POCKETS                   |
| 3. CLEAR POCKET FOR MAPS & CELL PHONES |   |





# PURPOSE-DRIVEN STORAGE SOLUTIONS



PATENT PENDING

\*ACCESSORIES SHOWN NOT INCLUDED

## DEER SPECIFIC POCKETS

1. FIELD GEAR STORAGE
2. AMMO/ACCESSORY POCKETS
3. EXTRA LONG POCKET FOR SHOOTING STICKS AND BIPODS
4. FLAP FOR CLOTHING OR EXTRA GEAR

**NEW**

## 2.0 GEAR FIT PURSUIT™ BRUISER™ DEER RIFLE CASE: 48IN

- HEAVY-DUTY DUAL-DENSITY FOAM FOR ULTIMATE PROTECTION
- FULLY LOCKABLE
- EASY CLEAN LINER

MO COUNTRY DNA  
965-48 \ 4 PK \ 026509064671



\*ACCESSORIES SHOWN NOT INCLUDED

## DEER SPECIFIC POCKETS

1. FIELD GEAR STORAGE
2. SCENT COVER SPRAY STORAGE
3. CALLS AND HUNTING ACCESSORIES STORAGE

## GEAR FIT PURSUIT™ BRUISER™ DEER RIFLE CASE: 48IN

- HEAVY-DUTY DUAL-DENSITY FOAM FOR ULTIMATE PROTECTION
- LOCKABLE
- EASY CLEAN LINER

MO BU COUNTRY  
945-48 \ 4 PK \ 026509020424

PATENTED  
#US D852,501 S

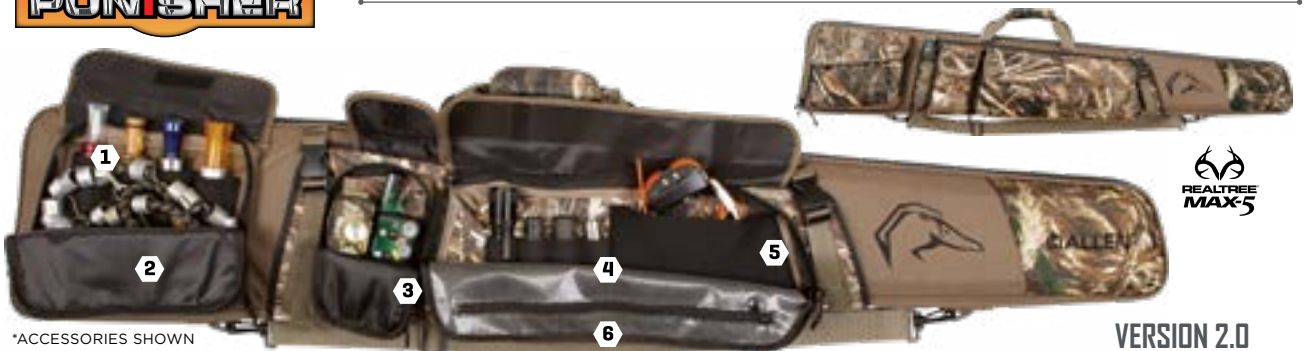

\*ACCESSORIES SHOWN NOT INCLUDED

VERSION 2.0  
COMING SOON

## WATERFOWL SPECIFIC POCKETS

- |                       |                              |
|-----------------------|------------------------------|
| 1. CALL STORAGE       | 5. DOG TRAINING GEAR STORAGE |
| 2. LANYARD STORAGE    | 6. WEATHERPROOF STORAGE      |
| 3. FIELD GEAR STORAGE |                              |
| 4. CHOKE TUBE STORAGE |                              |

## GEAR FIT PURSUIT™ PUNISHER™ WATERFOWL SHOTGUN CASE: 52IN

- HEAVY-DUTY DUAL-DENSITY FOAM FOR ULTIMATE PROTECTION
- LOCKABLE

RT MAX-5  
948-52 \ 4 PK \ 026509020387

PATENTED  
#US D850,788 S

**ROCKY DOUBLE  
RIFLE CASE: 50IN**

- HOLDS TWO RIFLES SIDE BY SIDE/PADDED
- DAISY CHAIN LOOPS
- PLUSH LINING
- LOCKABLE ZIPPERS

BLACK/TAN  
906-50 \ 1PK \ 026509036159



**RUGER® BASTION  
RIFLE CASE: 55IN**

- LONGER SHAPE DESIGNED TO FIT PERFORMANCE RIFLES
- HEAVY-DUTY FOAM
- INTERIOR ADJUSTABLE STRAP SYSTEM
- LOCKABLE

BLACK/GREY  
29729 \ 4PK \ 026509044321



**TEJON OVERSIZED  
GUN CASE: 50IN**

- WIDE DESIGN FOR GUNS WITH BIPODS & LARGE SCOPES
- THREE ACCESSORY POCKETS
- HEAVY FOAM PADDING

MOSSY OAK COUNTRY  
983-50 \ 4 PK \ 026509983507



**MCCOY RIFLE CASE: 50IN**

- EXTRA DENSE FOAM PADDING
- SMALL ACCESSORY POCKET
- LOCKING ZIPPER

BLACK/GREY  
654-50 \ 4PK \ 026509039334



**RUGER® PRESCOTT  
RIFLE CASE: 46IN**

- 100% COTTON CANVAS QUILTED EXTERIOR
- FAUX SUEDE TRIM
- LARGE GUSSETED POCKETS
- LOCKING CASE

BROWN  
29733 \ 4PK \ 026509044727







**KENOSHA RIFLE CASE: 50IN**

- EXTRA DENSE FOAM PADDING
- LARGE GUSSETED POCKETS
- ADJUSTABLE SLING
- LOCKING ZIPPER

GREY\INDIGO

**642-50 \ 4PK \ 026509039273**



**MOHAVE RIFLE CASE: 50IN**

- EXTRA DENSE FOAM PADDING
- OVERSIZED ZIPPERED ACCESSORY POCKET
- FRONT LASH STRAPS
- LOCKING ZIPPER

BROWN\HEATHER

**658-50 \ 4PK \ 026509039365**



**RUGER® AMERICAN RIFLE CASE: 46IN**

- DESIGNED FOR RUGER® AMERICAN RIFLES OR 46 INCH SCOPED RIFLES
- THICK FOAM PADDING
- LOCKABLE

BLACK, RIFLE, 46IN

**29735 \ 4 PK \ 026509044741**



**ATACS RIFLE CASE: 48IN**

- MULTIPLE ACCESSORY POCKETS
- DUAL-LAYER FOAM PADDING
- PADDED HANDLE GRIP
- LOCKABLE

ATACS-AU, 48IN X 9IN

**679-48 \ 4 PK \ 026509026860**

**BONZ RIFLE CASE: 48IN**

- TWO ACCESSORY POCKETS
- PVC REINFORCED BOTTOM
- DUAL-LAYER FOAM PADDING
- LOCKABLE ZIPPERS

BONZ CAMO  
**687-48 \ 4 PK \ 026509687481**



**TORREY RIFLE CASE: 46IN**

- PADDED CARRY HANDLES
- TWO LARGE ZIPPER POCKETS
- BRUSHED TRICOT INTERIOR WITH SLEEVE TO HOLD THE RIFLE IN PLACE
- LOCKABLE

TAN  
**550-46 \ 4 PK \ 026509046004**



**HUNTSMAN RIFLE CASE: 46IN**

- DENSE FOAM PADDING
- ZIPPERED ACCESSORY POCKET
- LOCKING ZIPPER

TAUPE\BROWN, RIFLE, 46IN  
**636-46 \ 4PK \ 026509039235**



**SUMMIT GUN CASES**

- DENSE FOAM PADDING
- TWO ZIPPERED ACCESSORY POCKETS
- ONE EASY VIEW MESH POCKET
- LOCKING ZIPPER

MOSSY OAK COUNTRY\VIOLET, RIFLE, 46IN  
**669-46 \ 4PK \ 026509039600**



**SAWATCH RIFLE CASE: 46IN**

- DENSE FOAM PADDING
- 1 EASY VIEW MESH POCKET
- LOCKING ZIPPER

TAN\BLACK, RIFLE, 46IN  
**682-46 \ 4PK \ 026509039495**







**HUMBOLT SHOTGUN CASE: 52IN**

- 100% COTTON CANVAS BODY/ENDURA ACCENTS
- REMOVABLE CHOKE TUBE ORGANIZER
- QUILTED INTERIOR
- LOCKABLE

TAN/BROWN  
**821-52 \ 4 PK \ 026509043560**



**DAYTONA GUN CASE**

- FOUR ACCESSORY POCKETS
- ADJUSTABLE SLING
- EASY CLEAN LINING

SHOTGUN, 52IN  
**994-52 \ 4 PK \ 026509994527**  
 RIFLE, 46IN  
**995-46 \ 4 PK \ 026509995463**



**GIRLS WITH GUNS®  
 FOILED GUN CASES**

- LARGE FRONT ZIP POCKET
- HEAVY-DUTY FOAM
- LOCKABLE ZIPPER

GOLD FOIL, RIFLE, 46IN  
**90-46 \ 4 PK \ 026509047612**



**GIRLS WITH GUNS®  
 TEN POINT DREAMS  
 RIFLE CASE, 46IN**

- LARGE FRONT ZIP POCKET
- HEAVY-DUTY FOAM
- LOCKABLE ZIPPER

SHADE™, RIFLE, 46IN  
**91-46 \ 4 PK \ 0265090476054**



**GIRLS WITH GUNS®  
 MIDNIGHT GUN CASES**

- FLAP POCKET FOR ACCESSORIES
- DURABLE LINING
- LOCKABLE

SHADE™ BLACKOUT CAMO, RIFLE, 46IN  
**907-46 \ 4 PK \ 026509054399**  
 SHADE™ BLACKOUT CAMO, SHOTGUN 52IN  
**907-52 \ 4 PK \ 0265090544054**

**RUGER® FLAGSTAFF 10/22®  
RIFLE CASE: 40IN**

- DESIGNED TO FIT MODERN SCOPES
- THREE ACCESSORY POCKETS
- EASY CLEAN LINING
- LOCKABLE ZIPPERS

BLACK\RED  
375-40 \ 4 PK \ 026509375401



Improved height  
to fit modern scopes

**RUGER® AMERICAN RIFLE®  
CASE: 46IN**

- ACCESSORY POCKET
- THICK FOAM PADDING
- PADDED HANDLE GRIP
- LOCKABLE ZIPPERS

BLUE/GREY  
27433 \ 6 PK \ 026509012337



**RUGER® YUMA 10/22®  
RIFLE CASE: 40IN**

- ACCESSORY POCKET
- THICK FOAM PADDING
- LOCKABLE ZIPPERS
- NEW TALLER FORMAT FITS SCOPES

BLACK  
29732 \ 4 PK \ 026509044710



Improved height  
to fit modern scopes

**RUGER® BLACKWATER  
TAKEDOWN CASE: 25IN**

- TAKEDOWN FORMAT WITH SEPARATE COMPARTMENTS
- LOCKING CASE
- HANGING D-RING

GREY  
29734 \ 4 PK \ 026509044734



FITS: RUGER® PC CARBINE™  
AND 10/22 TAKEDOWN®  
STYLE RIFLES



**RUGER® RIFLE CASE: 40IN**

- ZIPPERED ACCESSORY POCKET
- DENSE FOAM PADDING
- RUGGED ENDURA FABRIC

BLACK  
27140 \ 6 PK \ 026509271406







**RUGER® EMBROIDERED 10\22®  
RIFLE CASE: 40IN**

- DENSE FOAM PADDING
- SELF-HEALING ZIPPER
- RUGGED ENDURA FABRIC

BLACK  
275-40 \ 6 PK \ 026509275404



**RUGER® MESA RIFLE  
CASE: 46IN**

- DENSE FOAM PADDING
- LOCKING ZIPPER
- HANGING LOOP

BLACK  
274-46 \ 4PK \ 026509039488



**SPRINGS COMPACT  
RIFLE CASE: 32IN**

- DUAL LAYER FOAM PADDING
  - EASY CLEAN LINING
  - LOCKABLE ZIPPER
- GRAY\ORANGE,

317-32 \ 4 PK \ 026509024552



**BELFORD GUN CASES**

- DENSE FOAM PADDING
- ZIPPERED ACCESSORY  
POCKET WITH GUSSET
- LOCKING ZIPPER

BROWN, RIFLE CASE, 46IN  
612-46 \ 4PK \ 026509033356  
BROWN, SHOTGUN, 52IN  
612-52 \ 4PK \ 026509033363



**PLATA RIFLE CASE: 50IN**

- THICK FOAM PADDING FOR ULTIMATE PROTECTION
- LOCKABLE
- SOFT KNIT LINING

951-50 \ 4PK \ 026509054566



**EMERALD GUN CASES**

- DENSE FOAM PADDING
- LOCKING ZIPPER • HANGING LOOP
- EASY CLEAN, NON-ABSORBENT LINING



MOSSY OAK COUNTRY\GREEN, RIFLE, 46IN

628-46 \ 4PK \ 026509039136

MOSSY OAK COUNTRY\GREEN, SHOTGUN, 52IN

628-52 \ 4PK \ 026509039150



REALTREE EDGE\GREEN, RIFLE, 46IN

629-46 \ 4PK \ 026509039143

REALTREE EDGE\GREEN, SHOTGUN, 52IN

629-52 \ 4PK \ 026509039167



**POWELL GUN CASES**

- DENSE FOAM PADDING
- LARGE EXTERIOR ACCESSORY POCKET
- LOCKING CASE

BLACK\GREEN, 46IN

693-46 \ 4PK \ 026509049029

BLACK\GREEN, SHOTGUN, 52IN

693-52 \ 4PK \ 026509049036



**REDMESA GUN CASES**

- DENSE FOAM PADDING
- LOCKING ZIPPER
- EASY CLEAN, NON-ABSORBENT LINING



CAMO\GREEN, RIFLE, 46IN

443-46 \ 6PK \ 026509443469

CAMO\GREEN, SHOTGUN, 52IN

442-52 \ 6PK \ 026509442523





MADE IN THE USA 

**TIN CAN RIFLE CASE: 40<sub>IN</sub>**

- DENSE FOAM PADDING
- LOCKING ZIPPER
- HANGING LOOP

CINNAMON  
349-40 \ 6PK \ 026509349402



MADE IN THE USA 

**MARLIN® RIFLE CASE: 42<sub>IN</sub>**

- DENSE FOAM PADDING
- LOCKING ZIPPER
- HANGING LOOP

BLUE\TAN, RIFLE, 42IN  
652-42 \ 4PK \ 026509039327



MADE IN THE USA 

**ELDORADO GUN CASES**

- DENSE FOAM PADDING
- LOCKING ZIPPER
- EASY CLEAN, NON-ABSORBENT LINING

TAN\CAMO, RIFLE, 46IN  
692-46 \ 4PK \ 026509039112



**PARRY GUN CASES**

- DENSE FOAM PADDING
- DURABLE 60D POLYESTER EXTERIOR
- LOCKING CASE

BRONZE/BROWN, RIFLE, 46IN  
696-46 \ 4PK \ 026509048985  
BRONZE/BROWN, SHOTGUN, 52IN  
696-52 \ 4PK \ 026509048992



 MADE IN THE USA 

**MOSSY OAK BREAK UP BLAZE RIFLE CASE: 48<sub>IN</sub>**

- DENSE FOAM PADDING
- 1.5IN WEBBING HANDLES
- HANGING LOOP

MOSSY OAK BREAK UP BLAZE, RIFLE, 48IN  
673-48 \ 6PK \ 026509049364





**PATRIOT SERIES GUN CASES**

- LOCKABLE
- DURABLE ENDURA EXTERIOR
- SOFT, NON-WOVEN INTERIOR
- CUSTOM RED, WHITE & BLUE CAMO

HANDGUN, 9IN  
**950-9 \ 4PK \ 026509054498**  
 TACTICAL, 42IN  
**950-42 \ 4PK \ 026509054559**  
 RIFLE, 46IN  
**950-46 \ 4PK \ 026509054535**



**DURANGO BLACK RIFLE CASE: 32IN**

- FOR MINI .22 RIFLES OR PISTOL GRIP SHOTGUNS
- DENSE FOAM PADDING

BLACK, RIFLE, 32IN  
**601-32 \ 6PK \ 026509039006**



**DURANGO RIFLE CASES**

- DENSE FOAM PADDING
- EASY CLEAN, NON-ABSORBENT LINING

BLACK, RIFLE, 40IN  
**602-40 \ 6PK \ 026509039013**  
 BLACK, RIFLE, 46IN  
**602-46 \ 6PK \ 026509039020**  
 TAN\BLACK, RIFLE, 46IN  
**604-46 \ 6PK \ 026509039051**



**DURANGO SHOTGUN CASES**

- DENSE FOAM PADDING
- EASY CLEAN, NON-ABSORBENT LINING

BLACK, SHOTGUN, 52IN  
**602-52 \ 6PK \ 026509039068**  
 BLACK, SHOTGUN, 54IN  
**602-54 \ 6PK \ 026509039105**  
 TAN\BLACK, SHOTGUN, 52IN  
**604-52 \ 6PK \ 026509039099**



**DURANGO ASSORTED COLORS CASES**

- DENSE FOAM PADDING
- RUGGED ENDURA FABRIC

ASSORTED COLORS, RIFLE, 46IN  
**269-46 \ 6PK \ 026509269465**  
 ASSORTED COLORS, SHOTGUN, 52IN  
**268-52 \ 6PK \ 026509268529**





# PATRIOT, VICTORY, & DURANGO CASES

THESE CASES ARE ALL MADE IN THE USA AND DESIGNED WITH A CUSTOM FLAG PATTERN TO SHOW OUR SUPPORT OF THE 2ND AMENDMENT.



MADE IN THE USA

## VICTORY DUPLEX HANDGUN CASE

- FITS TWO HANDGUNS
- THICK FOAM PADDING
- INTERNAL MAGAZINES STORAGE
- SOFT KNIT LINING
- LOCKABLE

INTERNAL SIZE: 13.25IN X 8.75IN  
7609 \ 4 PK \ 026509076094



MADE IN THE USA

## VICTORY AUTOFIT 1-POCKET HANDGUN CASE

- THICK FOAM PADDING
- STORAGE POCKET FOR ACCESSORIES
- LOCKABLE • SOFT KNIT LINING

INTERNAL SIZE: 9IN X 7IN  
7719 \ 4 PK \ 026509077190



MADE IN THE USA

## VICTORY TACTICAL RIFLE CASE: 42IN

- THICK FOAM PADDING
- MULTIPLE EXTERNAL POCKETS FOR MAGAZINES AND GEAR
- LOCKABLE • SOFT KNIT LINING

INTERNAL SIZE: 42IN X 10IN  
1062 \ 6 PK \ 026509010623



MADE IN THE USA

## VICTORY WEDGE TACTICAL CASE: 41IN

- THICK FOAM PADDING
- MULTIPLE EXTERNAL POCKETS FOR MAGAZINES AND GEAR
- LOCKABLE
- SOFT KNIT LINING

INTERNAL SIZE: 41IN X 11IN  
10904 \ 6 PK \ 026509109044



MADE IN THE USA

## CENTENNIAL GUN CASE

- THICK FOAM PADDING
- STORAGE POCKET FOR ACCESSORIES
- LOCKABLE • SOFT KNIT LINING
- PADDED HOOK AND LOOP CARRY HANDLE

52IN SHOTGUN, INTERNAL SIZE: 52IN X 7IN  
690-52 \ 6 PK \ 026509018834  
46IN RIFLE, INTERNAL SIZE: 46IN X 9IN  
691-46 \ 4 PK \ 026509691464



MADE IN THE USA

## VICTORY RIFLE CASE: 48IN

- THICK FOAM PADDING
- STORAGE POCKETS FOR ACCESSORIES
- LOCKABLE • SOFT KNIT LINING
- PADDED HOOK AND LOOP CARRY HANDLE

INTERNAL SIZE: 48IN X 9IN  
587-48 \ 4 PK \ 026509587484

**NEW**

**PISTOL POUCHES**

- WRITEABLE ID LABEL
- CUSHIONED FLEECE LINING
- EASY OPEN ZIPPER
- LOCKABLE



PACKAGING EXAMPLE



**WRITABLE ID TAG**



GRAY - COMPACT - 5IN X 7IN  
3625 \ 6 PK \ 026509064954



GRAY - FULLSIZE - 7IN X 9IN  
3627 \ 6 PK \ 026509064978



GRAY - OVERSIZED - 9IN X 11IN  
3629 \ 6 PK \ 026509064992



BLACK - COMPACT - 5IN X 7IN  
3626 \ 6 PK \ 026509064961



BLACK - FULLSIZE - 7IN X 9IN  
3628 \ 6 PK \ 026509064985



BLACK - OVERSIZED - 9IN X 11IN  
3630 \ 6 PK \ 026509065005

**NEW**

**GIRLS WITH GUNS<sup>®</sup> PISTOL POUCHES**

- WRITEABLE ID LABEL
- CUSHIONED FLEECE LINING
- EASY OPEN ZIPPER
- LOCKABLE



GRAY - COMPACT - 5IN X 7IN  
9073 \ 6 PK \ 026509064930



GRAY - FULLSIZE - 7IN X 9IN  
9074 \ 6 PK \ 026509064947



**WRITABLE ID TAG**

**NEW**

**RUGER<sup>®</sup> PISTOL POUCHES**

- WRITEABLE ID LABEL
- CUSHIONED FLEECE LINING
- EASY OPEN ZIPPER
- LOCKABLE



BLACK - COMPACT - 5IN X 7IN  
27504 \ 6 PK \ 026509064916



BLACK - FULLSIZE - 7IN X 9IN  
27505 \ 6 PK \ 026509064923



**WRITABLE ID TAG**



**GUN POUCHES**



**WRITABLE  
ID TAG**



**NEW**

**GUN POUCHES**

- WRITEABLE ID LABEL
- CUSHIONED FLEECE LINING
- EASY OPEN ZIPPER
- LOCKABLE



GRAY - RIFLE - 46IN  
3633 \ 6 PK \ 026509065036



BLACK - RIFLE - 46IN  
3634 \ 6 PK \ 026509065043



GRAY - SHOTGUN - 52IN  
3631 \ 6 PK \ 026509065012



BLACK - SHOTGUN - 52IN  
3632 \ 6 PK \ 026509065029

**GUN SOCK-HANDGUNS: 14IN**

- FITS MOST HANDGUNS
- SILICONE TREATED KNIT FABRIC
- WILL NOT HOLD MOISTURE
- DRAWSTRING CLOSURE



GRAY  
1314 \ 12 PK \ 026509013143

**OVERSIZED GUN SOCK: 52IN**

- FITS EXTRA HIGH SCOPES
- 4 1/2IN X 52IN



BLACK\GRAY  
13105 \ 12 PK \ 026509131052

**MUZZLELOADER\RECURVE GUN SOCK: 66IN**



GRAY  
13166 \ 12 PK \ 026509131663

**KNIT GUN SOCK: 52IN**

- GREEN  
133 \ 12 PK \ 026509001331
- TAN  
167 \ 6 PK \ 026509001676
- GREEN\BLACK  
168 \ 6 PK \ 026509001683



**KNIT GUN SOCK: 52IN**



- GRAY (SHOWN)  
131 \ 12 PK \ 026509001317
- GRAY - 3 PACK  
13130 \ 6 PK \ 026509131304
- GRAY - 6 PACK  
13160 \ 6 PK \ 026509131601

**DUCKS UNLIMITED<sup>®</sup> GUN SOCK: 52IN**



GREEN  
138 \ 12 PK \ 026509001386

**ROCKY MOUNTAIN ELK FOUNDATION<sup>®</sup> GUN SOCK: 52IN**



GRAY  
137 \ 12 PK \ 026509001379

**GUN SLEEVE**

- ASSORTED EARTH TONE COLORS
- SOFT NON-WOVEN FABRIC
- GENEROUSLY CUT TO ALLOW EASY INSTALLATION OR REMOVAL



52IN FITS SHOTGUNS, ASSORTED  
122 \ 12 PK \ 026509001225

48IN FITS RIFLES, ASSORTED  
123 \ 12 PK \ 026509001232



BLACK



GREEN

## GUN SOCKS



WRITABLE  
ID TAG



**NEW**

### STRETCH KNIT HANDGUN SOCK: 14<sup>IN</sup>

- WRITEABLE ID LABEL
- STRETCHY SILICONE TREATED KNIT FABRIC
- WILL NOT HOLD MOISTURE
- DRAWSTRING CLOSURE

COYOTE

13170 \ 12 PK \ 026509064824

**NEW**

### STRETCH KNIT GUN SOCK: 52<sup>IN</sup>

- WRITEABLE ID LABEL
- STRETCHY SILICONE TREATED KNIT FABRIC
- WILL NOT HOLD MOISTURE
- DRAWSTRING CLOSURE

GRAY

13167 \ 12 PK \ 026509064794



**NEW**

### STRETCH KNIT GUN SOCK: 52<sup>IN</sup>

- WRITEABLE ID LABEL
- STRETCHY SILICONE TREATED KNIT FABRIC
- WILL NOT HOLD MOISTURE
- DRAWSTRING CLOSURE

BLACK

13173 \ 12 PK \ 026509064855



**NEW**

### STRETCH KNIT GUN SOCK: 52<sup>IN</sup>

- WRITEABLE ID LABEL
- STRETCHY SILICONE TREATED KNIT FABRIC
- WILL NOT HOLD MOISTURE
- DRAWSTRING CLOSURE

COYOTE

13172 \ 12 PK \ 026509064848



**NEW**

### STRETCH KNIT GUN SOCK: 52<sup>IN</sup>

- WRITEABLE ID LABEL
- STRETCHY SILICONE TREATED KNIT FABRIC
- WILL NOT HOLD MOISTURE
- DRAWSTRING CLOSURE

GREEN

13171 \ 12 PK \ 026509064831



**NEW**

### STRETCH KNIT GUN SOCK: 66<sup>IN</sup>

- WRITEABLE ID LABEL
- STRETCHY SILICONE TREATED KNIT FABRIC
- WILL NOT HOLD MOISTURE
- DRAWSTRING CLOSURE

GRAY

13169 \ 12 PK \ 026509064817





**EXO™ HANDGUN CASE**

- THERMO-MOLDED EXOSKELETON
- MICRO EGG-CRATE FOAM INTERIOR
- HEAVY-DUTY LOCKABLE ZIPPERS
- MOLDED RUBBER HANDLE

12IN BLACK, INTERNAL DIMENSIONS: 12IN X 7.25IN  
**82-12 \ 4 PK \ 026509026020**

9IN BLACK, INTERNAL DIMENSIONS: 9IN X 6.25IN  
**82-9 \ 4 PK \ 026509018858**

7IN BLACK, INTERNAL DIMENSIONS: 7IN X 5.25IN  
**82-7 \ 4 PK \ 026509018841**

FITS  
1-11

FITS  
1-7

82-12:  
INTERNAL SIZE:  
12IN X 7.25IN

FITS  
1-5

**SIZE CHART**  
BASED ON  
BARREL LENGTH

**AUTO LOADERS**



**REVOLVERS**



**NEW**  
**RUGER® PHOENIX  
 HARDSHELL HANDGUN CASES**

- THERMO-MOLDED EXOSKELETON
- MICRO EGG-CRATE FOAM INTERIOR
- HEAVY-DUTY LOCKABLE ZIPPERS
- MOLDED RUBBER HANDLE

9IN BLACK, INTERNAL DIMENSIONS: 9IN X 6.25IN  
**27502 \ 4 PK \ 026509064510**

7IN BLACK, INTERNAL DIMENSIONS: 7IN X 5.25IN  
**27503 \ 4 PK \ 026509064527**

FITS  
1-7

FITS  
1-5



## ATTACHE CASES



FITS  
1-11

SINCE  
**HERITAGE**  
1970

### HERITAGE SELECT ATTACHE CASE: 11IN

- 100% COTTON CANVAS SHELL
- MAIN POCKET HAS TWO SEPARATE ZIPPERED HANDGUN POCKETS
- 4 MAGAZINE SLOTS
- LOCKABLE MAIN POCKET

8245 \ 4PK \ 026509035213



FITS  
1-11

### DOUBLE HANDGUN ATTACHE CASE

- TWO LARGE PADDED SLEEVE POCKETS FOR HANDGUNS
- ZIPPERED REAR POCKET WITH FOLD OUT SHOOTING MAT
- LOCKABLE

7603 \ 3PK \ 026509036203



FITS  
1-11

### JACKSON ATTACHE CASE

- HOLDS TWO GUNS IN SPECIALLY DESIGNED INTERNAL POCKETS
- SOFT, PADDED LINING
- LOCKABLE MAIN POCKET

50-22 \ 3PK \ 026509046851

**AUTO-FIT 2.0 HANDGUN CASE: 11IN**

- THICK FOAM PADDING
- SOFT KNIT INTERIOR LINING FOR WEAPON PROTECTION
- DESIGNED TO FIT MOST SEMI-AUTO HANDGUNS AND SOME REVOLVERS
- LOCKABLE ZIPPER



11IN, GREY\RED  
7757 \ 4 PK \ 026509056218

FITS 1-7



11IN, BLACK  
7758 \ 4 PK \ 026509056232

FITS 1-7

**SIZE CHART**

BASED ON BARREL LENGTH

**AUTO LOADERS**



**REVOLVERS**



**AUTO-FIT 2.0 HANDGUN CASES: 7IN & 9IN**

- THICK FOAM PADDING
- SOFT KNIT INTERIOR LINING FOR WEAPON PROTECTION
- LOCKABLE ZIPPER



9IN, GREY\RED  
7748 \ 4 PK \ 026509056171

FITS 1-7



7IN, BLACK  
7753 \ 4 PK \ 026509056201

FITS 1-4

9IN, BLACK  
7749 \ 4 PK \ 026509056188

FITS 1-7

**TORREY HANDGUN CASES**

- ZIPPERED POCKET FOR SMALL ACCESSORIES
- INTERIOR MUZZLE POCKET
- LOCKABLE ZIPPER



10.5IN, COYOTE TAN  
3613 \ 4 PK \ 026509057925

FITS 1-6

11.5IN, COYOTE TAN  
3614 \ 4 PK \ 026509057932

FITS 1-7



10.5IN, BLACK  
3615 \ 4 PK \ 026509057949

FITS 1-6

11.5IN, BLACK  
3616 \ 4 PK \ 026509057956

FITS 1-7

**AUTO-FIT HANDGUN CASE: 7IN & 9IN**

- THICK FOAM PADDING
- SOFT KNIT INTERIOR LINING AND MUZZLE SLEEVE
- LOCKABLE ZIPPER



9IN, BLACK\RED  
7738 \ 4 PK \ 026509025986

FITS 1-7



9IN, BLACK\ORANGE  
7739 \ 4 PK \ 026509025993

FITS 1-7

**GWG<sup>®</sup> HANDGUN CASES**

- HEAVY-DUTY FOAM
- HANGING LOOP WITH D-RING
- LOCKABLE ZIPPER



BLACKOUT CAMO  
907-8 \ 6 PK \ 026509054382

FITS 1-7



SHADE™, HANDGUN, 8IN  
91-8 \ 6 PK \ 026509047650

FITS 1-7



GOLD FOIL, HANDGUN, 8IN  
90-8 \ 6 PK \ 026509047636

FITS 1-7





# HANDGUN CASES



**NEW**

## GWG® FREEDOM PISTOL CASE

- FITS HANDGUNS UP TO 10IN IN LENGTH
- THICK FOAM PADDING
- LOCKABLE ZIPPER

10IN LENGTH

9072 \ 6 PK \ 026509064657

FITS 1-11



**NEW**

## GWG® FREEDOM PISTOL CASE

- FITS HANDGUNS UP TO 10IN IN LENGTH
- THICK FOAM PADDING
- LOCKABLE ZIPPER

10IN LENGTH

9071 \ 6 PK \ 026509064640

FITS 1-11



**NEW**

## GWG® LOVE PISTOL CASE

- FITS HANDGUNS UP TO 10IN IN LENGTH
- THICK FOAM PADDING
- LOCKABLE ZIPPER

10IN LENGTH

9075 \ 6 PK \ 026509065173

FITS 1-11



## SUEDE HANDGUN CASE

- GENUINE SUEDE LEATHER
- FAUX SHERPA LINING
- THICK FOAM PADDING
- LOCKABLE ZIPPER

8IN LENGTH

86-8 \ 6 PK \ 026509044833

FITS 1-4

11IN LENGTH

86-11 \ 6 PK \ 026509044840

FITS 1-6

13IN LENGTH

86-13 \ 6 PK \ 026509044857

FITS 1-11



## LOCKABLE HANDGUN CASE

8IN LENGTH, BLACK/GRAY

444-8 \ 6 PK \ 026509040101

FITS 1-4

11IN LENGTH, BLACK/GRAY

444-11 \ 6 PK \ 026509040149

FITS 1-6

13IN LENGTH, BLACK/GRAY

444-13 \ 6 PK \ 026509032489

FITS 1-11



## LOCKING HANDGUN CASE

- THICK FOAM PADDING
- BUILT-IN LOCK WITH KEYS

8IN LENGTH

74-8 \ 6 PK \ 026509007487

FITS 1-4

11IN LENGTH

74-11 \ 6 PK \ 026509074113

FITS 1-6

13IN LENGTH

74-13 \ 6 PK \ 026509074137

FITS 1-11



## ASSORTED EARTH TONES HANDGUN CASE

6IN LENGTH

72-6 \ 6 PK \ 026509072065

FITS 1-2

8IN LENGTH

72-8 \ 6 PK \ 026509072089

FITS 1-4

11IN LENGTH

72-11 \ 6 PK \ 026509072119

FITS 1-6

13IN LENGTH

72-13 \ 6 PK \ 026509072133

FITS 1-11



Concealed Casual  
BY  
GIRLS WITH GUNS

DESIGNED BY WOMEN,  
FOR WOMEN



CONCEAL CARRY  
HANDBAGS

**GWG<sup>®</sup> COSMIC LARGE  
CONCEAL CARRY TOTE**

- CONCEAL CARRY POCKET ON FRONT WITH MAGNETIC CLOSURE AND LOCKABLE ZIPPERS
- BACK FLAT POCKET FOR SMALL ACCESSORIES
- OVER THE SHOULDER CARRY HANDLE
- INTERIOR ORGANIZATION IN THE MAIN COMPARTMENT
- INSULATED, SIDE ACCESS POCKET KEEPS DRINKS OR SNACKS COOL
- ATTACHED KEY FOB DISCREETLY HOLDS CONCEAL CARRY POCKET KEYS
- PEBBLE GRAIN PU LEATHER
- DIMENSIONS: 15.25IN L X 5IN W X 12.5IN H

**8231 \ 2 PK \ 026509051619**



CONCEAL  
CARRY  
POCKET



INSULATED  
POCKET  
USE AS A  
COOLER



HIDDEN  
KEYS  
FOR  
CONCEAL  
CARRY  
POCKET





# CONCEAL CARRY PURSES



## GWG<sup>®</sup> ADVENTURE CROSS BODY MEDIUM CONCEALED CARRY PURSE

- MEDIUM CROSSBODY CONCEAL CARRY TOTE
- ADJUSTABLE, REMOVABLE, CROSS BODY STRAP AND TOTE STYLE HANDLES
- BACK SLASH POCKET FOR SMALL ITEMS
- LOCKABLE PADDED CONCEAL CARRY POCKET WITH TOP ACCESS
- SIMPLISTIC DESIGN CAN BE WORN FRONT OR BACK TO ACCOMODATE RIGHT AND LEFT HAND CARRY
- INTERIOR ORGANIZATION IN MAIN COMPARTMENT
- ATTACHED KEY FOB DISCREETLY HOLDS CONCEAL CARRY POCKET KEYS
- BALLISTIC POLYESTER
- DIMENSIONS: 11IN L X 2IN W X 10IN H

BLACK/SILVER  
70635 \ 2 PK \ 026509051503



## GWG<sup>®</sup> TOMBOY CLUTCH SMALL CONCEALED CARRY PURSE

- SMALL CROSSBODY CONCEAL CARRY PURSE
- ADJUSTABLE, REMOVABLE CROSS BODY STRAP
- METAL MAIN ZIPPER WITH LONG ZIPPER PULL
- PADDED AND LOCKABLE CONCEALED CARRY POCKET ON FRONT OF PURSE
- INTERIOR ORGANIZATION IN MAIN COMPARTMENT
- BACK ZIP POCKET
- ATTACHED KEY FOB DISCREETLY HOLDS CONCEAL CARRY POCKET KEYS
- PU LEATHER
- DIMENSIONS: 10IN L X 6.5IN W X 2IN H

CAMO/GOLD  
90-90 \ 3 PK \ 026509053729





# HOLSTERS: CONCEAL CARRY OR JUST BE READY



## HIDEOUT BELLY BAND HOLSTER M-XL

- FITS 32IN-46IN (81CM-116CM) WAIST
- RIGHT OR LEFT-HANDED DRAW OR CROSS-DRAW
- COMFORTABLE FABRIC WITH VENTILATION
- DUAL LAYER HOLSTER POCKET
- ADJUSTABLE STRAP TO SECURE FIREARM
- TWO MAGAZINE POCKET
- FITS MOST CONCEAL CARRY HANDGUNS

BLACK, M-XL  
**44250 \ 4 PK \ 026509025436**



## HIDEOUT BELLY BAND HOLSTER XL-3XL

- FITS 46IN-60IN (116CM-125CM) WAIST
- RIGHT OR LEFT-HANDED DRAW OR CROSS-DRAW
- COMFORTABLE FABRIC WITH VENTILATION
- DUAL LAYER HOLSTER POCKET
- ADJUSTABLE STRAP TO SECURE FIREARM
- TWO MAGAZINE POCKETS
- FITS MOST CONCEAL CARRY HANDGUNS

BLACK, XL-3XL  
**44251 \ 4 PK \ 026509025443**



---

## HIDEOUT ANKLE HOLSTER

- ONE SIZE FITS MOST
- RIGHT OR LEFT-HANDED DRAW
- COMFORTABLE FABRIC WITH VENTILATION
- DUAL LAYER HOLSTER POCKET
- ADJUSTABLE STRAP TO SECURE FIREARM
- FITS MOST CONCEALED CARRY HANDGUNS

BLACK  
**44255 \ 4 PK \ 026509025467**





**AMBIDEXTROUS HOLSTER**

- SECURE THUMB BREAK CLOSURE
- MAGAZINE POUCH & ADJUSTABLE CLOSURE
- NYLON OUTER SHELL
- SMOOTH ENDURA LINING FOR QUICK DRAW
- SPRING STEEL BELT CLIP
- FITS BELTS UP TO 1.5IN WIDE
- RIGHT OR LEFT HAND

**SIZE: 01**  
3-4IN BARREL MD FRAME AUTO  
**44501 \ 4 PK \ 026509445012**

**SIZE: 03**  
4.5-5IN BARREL LG FRAME AUTO  
**44503 \ 4 PK \ 026509445036**

**SIZE: 05**  
3.75-4.5IN BARREL LG FRAME AUTO  
**44505 \ 4 PK \ 026509445050**

**SIZE: 06**  
3.25-3.75IN MD\LG FRAME AUTO  
**44506 \ 4 PK \ 026509445067**



**GLENWOOD BELT SLIDE HOLSTER**

- WORKS INSIDE OR OUTSIDE THE BELT
- MINIMAL BULK MAKES THIS RIG EASY TO CONCEAL UNDER A SHIRT OR JACKET
- FITS UP TO 1.5IN BELTS
- ATTACHES WITH BELT LOOPS OR METAL BELT OR WAIST BAND CLIP
- VERTICAL DRAW
- RIGHT OR LEFT HAND

**SIZE: 00**  
FIT STYLE: SMALL FRAME AUTO INCLUDING: BROWNING HIGH POWER, CZ75M, CZ75P07, COLT 1911; HKP7MB; KAHR P380, KAHR P9MM; RUGER® LCP, RUGER® SR9, RUGER® LC9; S&W BODY GUARD .380; WALTHER P5 AND PPKS  
BLACK  
**44830 \ 4 PK \ 026509448303**

**SIZE: 01**  
FIT STYLE: MEDIUM FRAME AND LARGE FRAME AUTO INCLUDING: BERETTA 92, PX4, VERTEC; GLOCK 17, 19, 21, 26, 30, 36; HK P2000; RUGER® P89 AND SIMILAR; SIG P220, P225, P226, P229; SPRING-FIELD XD SERIES; S&W M&P 40, 45 STANDARD AND COMPACT, 99, 4006, 5906; TAURUS 24\7; WALTHER P99  
BROWN  
**44821 \ 4 PK \ 026509448211**  
BLACK  
**44831 \ 4 PK \ 026509448310**



**RED MESA LEATHER HIP HOLSTER**

- FULL GRAIN LEATHER
- ADJUSTABLE SNAP CLOSURE
- RIGHT HAND

**SIZE: 01**  
FIT STYLE: REVOLVERS UP TO 4.5IN BARREL; .22 CALIBER SEMI-AUTO TO 5.5IN BARREL; COLT 1911; TOKAREV 9MM SEMI-AUTO  
**4491 \ 4 PK \ 026509044918**

**SIZE: 04**  
FIT STYLE: MOST REVOLVERS UP TO 6.5IN BARREL; RUGER® .22 SEMI-AUTO 5.25IN AND 6.5IN  
**4494 \ 4 PK \ 026509044949**

**SIZE: 05**  
FIT STYLE: MOST REVOLVERS 5.5IN TO 7IN  
**4495 \ 4 PK \ 026509057871**

# CONCEAL CARRY HOLSTERS



**STICKY SPIDERWEB HOLSTER STAYS SECURE IN YOUR POCKET FOR QUICK AND SMOOTH WEAPON DRAW.**

## SPIDERWEB™ HOLSTER

- TACKY RAISED SPIDERWEB GRIP
- SLICK LINING FOR EASY GUN REMOVAL
- RIGHT OR LEFT HAND



**SIZE: 00**  
2-3IN REVOLVER  
44902 \ 4 PK \ 026509008453

**SIZE: 01**  
3-4IN MD AUTO  
44901 \ 4 PK \ 026509008460

**SIZE: 04**  
RUGER® LCP, SMALL 380  
44904 \ 4 PK \ 026509008484

**SIZE: 10**  
S&W SHIELD W\ LASER SINGLE STK 9MM  
44910 \ 4 PK \ 026509008514

**SIZE: 11**  
RUGER® LC9, COMPACT 9MM  
44911 \ 4 PK \ 026509008521



**SIZE: 05**  
RUGER® SR9C, GLOCK 26, 27  
44905 \ 4 PK \ 026509012269

## CORTEZ NYLON HOLSTER

- ADJUSTABLE STRAP • RIGHT HAND
- EASY OPEN SNAP WITH LEVER
- MOLDED BELT LOOP FITS UP TO 2IN BELT
- SMOOTH SNAG-PROOF LINING
- WEB SIGHT GUARD

**SIZE: 00**  
FIT STYLE: 2IN TO 3IN BARREL SM\MD  
DOUBLE ACTION REVOLVERS  
44800 \ 6 PK \ 026509448006

**SIZE: 01**  
FIT STYLE: 3IN TO 4IN MD FRAME AUTOS  
44801 \ 6 PK \ 026509448013

**SIZE: 02**  
FIT STYLE: 3IN TO 4IN MD\LG FRAME  
DOUBLE ACTION REVOLVERS  
44802 \ 6 PK \ 026509448020

**SIZE: 03**  
FIT STYLE: 5IN TO 6.5IN BARREL MD\LG DOUBLE  
ACTION REVOLVERS  
44803 \ 6 PK \ 026509448037

**SIZE: 04**  
FIT STYLE: 4.5IN TO 5IN BARREL LG AUTOS  
44804 \ 6 PK \ 026509448044

**SIZE: 05**  
FIT STYLE: SM .22 TO .25 CAL AUTOS  
44805 \ 6 PK \ 026509448051

**SIZE: 06**  
FIT STYLE: GLOCK 26, 27  
44806 \ 6 PK \ 026509448068

**SIZE: 07**  
FIT STYLE: 3.5IN-4.5IN BARREL LG AUTOS  
44807 \ 6 PK \ 026509448075

**SIZE: 08**  
FIT STYLE: 3.25IN TO 3.75IN BARREL  
MD\LG AUTOS  
44808 \ 6 PK \ 026509448082

**SIZE: 09**  
FIT STYLE: 2IN SM FRAME 5 SHOT  
REVOLVERS W\ HAMMER SPUR  
44809 \ 6 PK \ 026509448099

**SIZE: 10**  
FIT STYLE: 7IN TO 8.5IN BARREL MD\LG  
DOUBLE ACTION REVOLVERS  
44810 \ 6 PK \ 026509448105

**SIZE: 13**  
FIT STYLE: 5.5IN TO 6.5IN BARREL SINGLE  
ACTION REVOLVERS  
44813 \ 6 PK \ 026509448136

**SIZE: 16**  
FIT STYLE: 5.5IN TO 6IN BARREL .22 AUTOS  
44816 \ 6 PK \ 026509448167

**SIZE: 18**  
FIT STYLE: 6IN BARREL, S&W N-FRAME,  
AND TAURUS RAGING BULL DOUBLE  
ACTION REVOLVER WITH FULL LUG  
44818 \ 6 PK \ 026509448181







SIZE: 00      SIZE: 01      SIZE: 07      SIZE: 08

**PADDED SECURE CLIP HOLSTER FOR A SMOOTH WEAPON DRAW.**



SIZE: 03

**SIZE: 00**  
 FITS: MOST 2 TO 3 IN BARREL DOUBLE ACTION REVOLVERS  
**44400 \ 6PK \ 026509034582**

**SIZE: 01**  
 FITS: MOST SUBCOMPACT .380 CAL SEMI-AUTOS  
**44401 \ 6PK \ 026509034599**

**SIZE: 03**  
 FITS: MOST 4.5 TO 5 INCH BARREL FULL-SIZED SEMI-AUTOS  
**44403 \ 6PK \ 026509034605**

**SIZE: 04**  
 FITS: MOST SUBCOMPACT .22 CAL AND .25ACP SEMI-AUTOS  
**44404 \ 6PK \ 026509034612**

**IWB - FLASH HOLSTER**

- EASY ATTACHING MOLDED BELT CLIP
- FITS BELTS UP TO 1.5IN
- THIN PROFILE FOR EASY CONCEALMENT
- SMOOTH ENDURA LINING FOR FASTER DRAW
- LAMINATED CONSTRUCTION INCLUDES FOAM PADDING FOR COMFORT, AND MOISTURE RESISTANT LINING
- RIGHT HANDED

**SIZE: 05**  
 FITS: MOST SUBCOMPACT 9MM AND .40 CAL SEMI-AUTOS  
**44405 \ 6PK \ 026509034629**

**SIZE: 06**  
 FITS: MOST 3.5 TO 4.5 INCH BARREL COMPACT SEMI-AUTOS  
**44406 \ 6PK \ 026509034636**

**SIZE: 07**  
 FITS: MOST 3.25 TO 3.75 INCH COMPACT SEMI-AUTOS  
**44407 \ 6PK \ 026509034643**

**SIZE: 08**  
 FITS: MOST 2 INCH BARREL SMALL FRAME SINGLE ACTION REVOLVERS  
**44408 \ 6PK \ 026509034667**



**SIZE: 00**  
 FIT STYLE: 2IN TO 3IN BARREL SM\MD DOUBLE ACTION REVOLVERS  
**44600 \ 4 PK \ 026509446002**

**SIZE: 01**  
 FIT STYLE: 3IN TO 4IN MD FRAME AUTO  
**44601 \ 4 PK \ 026509446019**

**SIZE: 03**  
 FIT STYLE: 4.5IN TO 5IN BARREL LG AUTO  
**44603 \ 4 PK \ 026509446033**

**SIZE: 04**  
 FIT STYLE: SM AUTOS .22 CAL TO .25 CAL WITH HAMMER SPUR  
**44604 \ 4 PK \ 026509446040**

**INSIDE THE PANT HOLSTER**

- EASY ATTACHING MOLDED BELT CLIP
- FITS UP TO 2IN BELT
- THIN PROFILE MAKES FOR EASY CONCEALMENT
- SNAG PROOF ENDURA LINING FOR QUICK DRAW
- LAMINATED CONSTRUCTION INCLUDES FOAM PADDING FOR COMFORT
- MOISTURE RESISTANT LINING
- RIGHT HAND

**SIZE: 05**  
 FIT STYLE: GLOCK 26, 27  
**44605 \ 4 PK \ 026509446057**

**SIZE: 06**  
 FIT STYLE: 3.5IN TO 4.5IN BARREL LG AUTOS  
**44606 \ 4 PK \ 026509446064**

**SIZE: 07**  
 FIT STYLE: 3.25IN TO 3.75IN BARREL MD\LG AUTOS  
**44607 \ 4 PK \ 026509446071**

**SIZE: 08**  
 FIT STYLE: 2IN SM FRAME 5 SHOT REVOLVERS WITH HAMMER SPUR  
**44608 \ 4 PK \ 026509446088**

# MAGNETIC

## GUN MOUNTS & HOLDERS:

**NEW**

### TWO PIECE DISC MAGNETIC SET

- POWERED BY RARE-EARTH MAGNETS
- COATED TO PREVENT SCRATCHING
- HOLDS GUNS AND TOOLS
- COMPLETE WITH MOUNTING SCREWS
- EACH MAGNET: 1.375IN DIA X .375IN TALL (3.49CM DIA X .95CM TALL)

BLACK

**5649 \ 4 PK \ 026509060277**



GREAT FOR:  
CONCEALED  
HANDGUN  
STORAGE,  
TOOLS, OR OTHER  
ACCESSORIES



### MAGNETIC HANDGUN MOUNT

- RUBBER COATING PROTECTS GUN
- HOLDS UP TO 35LBS
- SCREWDRIVER, 6 SCREWS AND 6 DRYWALL ANCHORS INCLUDED FOR EASY ASSEMBLY
- HIGH STRENGTH ADHESIVE TAPE INCLUDED
- MAGNET: 3.75IN X 1.38IN X .35IN (9.5CM X 3.5CM X .88CM)

BLACK

**18530 \ 4 PK \ 026509035626**



GREAT FOR:  
CONCEALED  
HANDGUN  
STORAGE,  
TOOLS, OR OTHER  
ACCESSORIES



**NEW**

### GUN READY RAIL GUN MAGNET

- POWERED BY RARE-EARTH MAGNETS
- HOLDS MOST SEMI-AUTOMATIC HANDGUNS
- RAILS KEEP MOST HANDGUNS ALIGNED VERTICALLY
- COMPLETE WITH MOUNTING SCREWS
- MAGNET: 2.5IN W X 4IN L (6.35CM W X 10.16CM L) BARREL CHANNEL IS 1.375IN W (3.49CM W)

BLACK

**5648 \ 4 PK \ 026509060260**



GREAT FOR:  
CONCEALED  
HANDGUN  
STORAGE





**NEW**

**MAGNETIC GUN AND ROD HOLDER, SINGLE**

- HOLDS ONE RIFLE OR SHOTGUN
- DESIGNED TO HOLD A GUN PROPPED UP AGAINST A METAL OBJECT
- MAGNETIC ATTACHMENT
- FLEXIBLE CLOSURE
- DIMENSIONS: 2.25IN X 1.75IN X 2.125IN (5.71CM X 4.44CM X 5.39CM)

BLACK  
**5657 \ 4 PK \ 026509061571**



GREAT FOR:  
 LONG GUNS,  
 PADDLES, OR  
 FISHING POLES

**NEW**

**MAGNETIC GUN AND ROD HOLDER, 3 GUN**

- HOLDS 3 GUNS OR 4 FISHING RODS
- ATTACHES WITH MAGNETIC BACK PANEL
- DESIGNED AS A PROP, NOT A HOLDING DEVICE
- NOT FOR USE IN A MOVING VEHICLE
- DIMENSIONS: 10IN X 2IN X 3IN (25.4CM X 5.08CM X 7.62CM)

BLACK  
**5658 \ 4 PK \ 026509061588**



GREAT FOR:  
 LONG GUNS,  
 PADDLES, OR  
 FISHING POLES





**NEW**  
**GUN COLLECTOR 3 PLACE**

- HARDWOOD BASE
- PADDED METAL HOOKS (3 PER BASE)
- HOOKS ARE POWDERCOATED
- MOUNTING SCREWS INCLUDED
- 23.25IN X 1.5IN X 3.25IN  
(59.05cm X 3.81cm X 8.25cm)

BLACK  
5656 \ 4 PK \ 026509061564



**NEW**  
**GUN COLLECTOR 2 PLACE**

- HARDWOOD BASE
- PADDED METAL HOOKS (2 PER BASE)
- HOOKS ARE POWDERCOATED
- MOUNTING SCREWS INCLUDED
- 15.5IN X 1.5IN X 3.25IN  
(39.37cm X 3.8cm X 8.25cm)

BLACK  
5659 \ 4 PK \ 0026509064756



**NEW**  
**STRONGHOLD STEEL HOOKS  
BLACK, 2 PACK**

- BLACK POWDER COATED STEEL CONSTRUCTION
- PADDED CRADLE AREA
- 2IN WIDE OPENING
- 3.5IN OVERALL LENGTH

BLACK  
5651 \ 4 PK \ 026509061519



**NEW**  
**STRONGHOLD STEEL HOOKS  
BRASS, 2 PACK**

- BRASS COATED STEEL CONSTRUCTION
- PADDED CRADLE AREA
- 2IN WIDE OPENING
- 3.5IN OVERALL LENGTH

BRASS  
5650 \ 4 PK \ 026509061502



**NEW**  
**DEFENDER COATED  
HOOKS W/ WOODEN  
PLAQUE, PAIR**

- HARDWOOD BASE
- PADDED METAL HOOKS
- HOOKS ARE POWDERCOATED
- MOUNTING SCREWS INCLUDED

BLACK  
5654 \ 4 PK \ 026509061540



**NEW**  
**DEFENDER COATED  
HOOKS WIDE, 2 PACK**

- POLYMER COATED METAL HOOK
- METAL MOUNTING PLATE
- 2.5IN WIDE TAPERED OPENING
- SCREWS AND DRYWALL ANCHORS INCLUDED

BLACK  
5653 \ 4 PK \ 026509061533



**NEW**  
**DEFENDER COATED  
HOOKS, 2 PACK**

- POLYMER COATED METAL HOOK
- METAL MOUNTING PLATE
- 2IN WIDE TAPERED OPENING
- SCREWS AND DRYWALL ANCHORS INCLUDED

BLACK  
5652 \ 4 PK \ 026509061526



**NEW**  
**DEFENDER COATED  
DOUBLE HOOKS**

- POLYMER COATED METAL HOOK
- METAL MOUNTING PLATE
- TWO PRONGS, 2 INCHES APART
- SCREWS AND DRYWALL ANCHORS INCLUDED

BLACK  
5646 \ 4 PK \ 026509060239



**TWO GUN, BOW OR TOOL RACK**

- METAL
- ADJUSTABLE 9IN TO 14IN HEIGHT
  - DESIGNED FOR PERMANENT ATTACHMENT
  - MOUNTING HARDWARE INCLUDED
- 18500 \ 6 PK \ 026509185000**



**TWO GUN, BOW OR TOOL RACK**

- MOLDED
- ADJUSTABLE 9IN TO 13IN HEIGHT
  - DESIGNED FOR ATTACHMENT WITHOUT TOOLS
- 17450 \ 6 PK \ 026509174509**



**THREE GUN LOCKING GUN RACK WITH STEEL CONSTRUCTION**

- METAL
- ADJUSTS TO FIT OVER WINDOWS FROM 18IN TO 26IN
  - PLASTISOL COATING PROTECTS GUNS AND TOOLS
  - PLASTIC COATED STEEL CABLE TO SECURING GUNS INCLUDED
  - STEEL CLIPS CAN BE FLEXED FOR MORE SECURE HOLD
  - 1/8IN DRILL BIT \ DRILL AND SCREWDRIVER REQUIRED
- 18520 \ 4 PK \ 026509185208**



**FOUR GUN WOODEN WALL RACK**

- SOLID WOOD CONSTRUCTION
- EACH GUN NOTCH IS LINED WITH FELT TO PROTECT THE FIREARM
- 24.5IN X 24.5IN X 4.25IN • EASY TO ASSEMBLE

**18550 \ 4 PK \ 026509185505**



**BRASS GUN HANGER**

- HANGS ANY GUN ON WALL OR IN CABINET
- DESIGNED TO HOLD GUN HORIZONTALLY
- LINED WITH FELT TO PROTECT THE FIREARM
- INSTALLS WITH FOUR BRASS PLATED SCREWS, PROVIDED

**5641 \ 6 PK \ 026509056416**



**STEEL AMMO BOX**

- LOCKABLE
- MADE OF STEEL
- STORES AMMO
- CARRY HANDLE

.30 CAL  
**5930 \ 8 PK \ 026509036005**

.50 CAL  
**5950 \ 4 PK \ 026509036012**

# NEXT SHOT

**NEW**  
**NEXT SHOT**  
**SHOTGUN SHELL HOLDER**

- HOLDS 3 SHOT SHELLS
- WORKS FOR 20, 16 OR 12 GAUGE
- SILICONE BAND WON'T HARM STOCKS

GRAY WITH BLACK BAND  
**8201 \ 6 PK \ 026509008859**



**NEW**  
**NEXT SHOT**  
**RIFLE CARTRIDGE HOLDER**

- HOLDS 4 CARTRIDGES
- FITS FROM .223 TO 300 WINCHESTER MAGNUM
- SILICONE BAND WON'T HARM STOCKS

GRAY WITH BLACK BAND  
**8208 \ 6 PK \ 026509051626**



**NEW**  
**NEXT SHOT**  
**MAGAZINE/ACCESSORY POUCH**

- HOLDS SPARE MAGAZINE OR WIND METER
- 4.5IN X 3IN X 1.25IN COMPARTMENT
- SILICONE BAND WON'T HARM STOCKS
- WINDOW POCKET FOR DOPE CARD SHOWING HOLD OVER AND WINDAGE ADJUSTMENT

GRAY WITH BLACK BAND  
**8282 \ 6 PK \ 026509008347**







**DELUXE AMMO CARRIER, ENDURA RIFLE**

- HOLDS 10 CARTRIDGES
- MOLDED BODY GIVES SUPERIOR PROTECTION
- INDIVIDUAL COMPARTMENTS HOLD EACH CARTRIDGE
- MAGNETIC CLOSURE WITH SILENT OPENING SECONDARY SECURE FLAP



MO BU COUNTRY  
232 \ 4 PK \ 026509002321



**SHELL HOLDER WITH COVER**

- SHOTGUN HOLDER HOLDS 5 ROUNDS
- RIFLE HOLDER HOLDS 8 ROUNDS
- ELASTIC BACK SLIDES OVER BUTTSTOCK
- QUIET FABRIC COVER



FITS SHOTGUN, MO BU COUNTRY  
2058 \ 6 PK \ 026509036302  
FITS RIFLE, MO BU COUNTRY  
2068 \ 6 PK \ 026509036319



**AMMO POUCH, RIFLE**

- EASY RELEASE BUCKLE
- ATTACHES TO ANY BELT UP TO 2.5in TALL
- 14 RIFLE SHELL LOOPS

RT EDGE  
17251 \ 6 PK \ 026509172512

**ELASTIC BUTTSTOCK SHELL HOLDER**

- STRETCHES OVER BUTTSTOCK FOR SNUG FIT
- SHOTGUN SHELL HOLDER FITS 5 SHOTGUN SHELLS
- RIFLE SHELL HOLDER FITS 9 RIFLE CARTRIDGES



FITS SHOTGUNS  
205 \ 6 PK \ 026509002055  
FITS RIFLES  
206 \ 6 PK \ 026509002062



**AMMO POUCH, ENDURA RIFLE**

- OPENS QUIETLY
- SIDE RELEASE CLOSURE
- ATTACHES TO ANY BELT
- 14 RIFLE SHELL LOOPS

RT EDGE  
17655 \ 6 PK \ 026509036296

BLACK  
17651 \ 6 PK \ 026509036289

**ADJUSTABLE BUTTSTOCK SHELL HOLDER**

- ADJUSTABLE HOOK AND LOOP STRAP ATTACHMENT SYSTEM
- LOOPS HOLD 5 CARTRIDGES
- ZIPPERED POCKET FOR OTHER ACCESSORIES



UNIVERSAL FIT  
20550 \ 6 PK \ 026509205500

**NEOPRENE STRETCH BUTTSTOCK SHELL HOLDER**

- 3MM STRETCH NEOPRENE AND STRETCH NYLON
- HOOK AND LOOP CLOSURES
- SPECIAL SLITS FOR SLING SWIVEL STUDS



FITS SHOTGUNS, MO BU COUNTRY  
20143 \ 6 PK \ 026509201434  
FITS RIFLES, MO BU COUNTRY  
20123 \ 6 PK \ 026509201236



# TACKY RUBBER TREAD FOR EXTREME GRIP



**SWIVELS TESTED TO OVER 500LBS. (226KG)**

## BAKTRAK® LEATHER SLING

- BAKTRAK® EXTREME GRIP BACK
- FULL GRAIN LEATHER
- SWIVELS TESTED TO 500LBS

BROWN LEATHER

**8391 \ 3 PK \ 026509010043**



## HERITAGE SLING

- BAKTRAK® EXTREME GRIP BACK
- COTTON CANVAS FRONT
- INCLUDES SWIVELS
- HEAVY-DUTY WEBBING
- SWIVELS TESTED TO 500LBS

OLIVE

**8110 \ 6PK \ 026509038917**



## BAKTRAK® RIFLE SLING

- BAKTRAK® RUBBER GRIP PANEL
- ULTRA DURABLE AND LIGHTWEIGHT
- QUICK ADJUST WITH METAL SLIDE BUCKLE
- SWIVELS TESTED TO 500LBS

REALTREE EDGE

**8470 \ 6 PK \ 026509000099**



## BAKTRAK® HEX SLING

- BAKTRAK® RUBBER GRIP PANEL
- ULTRA DURABLE AND LIGHTWEIGHT
- HYPALON CONSTRUCTION
- HEX PANEL TO ATTACH ACCESSORIES
- QUICK ADJUST WITH CAM LOCK BUCKLE
- SWIVELS TESTED TO 500LBS

MOBU COUNTRY

**8374 \ 6 PK \ 026509026709**



**BAKTRAK® BOULDER RIFLE SLING**

- 1.25IN HEAVY-DUTY WEBBING
- THUMB LOOP
- SWIVELS TESTED TO 500LBS

BLACK\GREY

**8355 \ 6 PK \ 026509083559**

**BAKTRAK® ASPEN RIFLE SLING**

- NUBUCK FACE WITH ACCENT STITCH
- 1.25IN HEAVY-DUTY WEBBING
- SWIVELS TESTED TO 500LBS

BLACK\GREY

**8357 \ 6 PK \ 026509083573**

**BAKTRAK® BULLET SLING**

- EXTREME GRIP BACK
- CUSHIONED FIT
- SWIVELS TESTED TO 500LBS

BLACK

**8385 \ 6 PK \ 026509010081**

**BAKTRAK® GLEN EAGLE RIFLE SLING**

- 1.25IN HEAVY-DUTY WEBBING
- THUMB LOOP
- SWIVELS TESTED TO 500LBS

BLACK

**8342 \ 6 PK \ 026509083429**



**GIRLS WITH GUNS®  
BAKTRAK® VAPOR RIFLE SLING**

- BAKTRAK® RUBBER GRIP PANEL
- SLEEK PROFILE MAXIMIZES COMFORT AND REDUCES WEIGHT
- QUICK ADJUST WITH CAM LOCK BUCKLE
- SWIVELS TESTED TO 500LBS

SHADE™ CAMO

**8471 \ 6 PK \ 026509000259**



**BAKTRAK® VAPOR RIFLE SLING**

- BAKTRAK® RUBBER GRIP PANEL
- SLEEK PROFILE MAXIMIZES COMFORT AND REDUCES WEIGHT
- QUICK ADJUST WITH CAM LOCK BUCKLE
- SWIVELS TESTED TO 500LBS

BLACK\RED

**8375 \ 6 PK \ 026509026716**

MO BU COUNTRY

**8376 \ 6 PK \ 026509026723**

**WEB SLING W/ BAKTRAK® TREAD**

- BAKTRAK® TREAD FOR SHOULDER GRIP
- QUICK ADJUSTING SLING
- SWIVELS TESTED TO 500LBS

BLACK

**8489 \ 6 PK \ 026509013457**



**GEAR FIT  
PURSUIT™**

**GEAR FIT® PURSUIT™ GUN SLINGS PROVIDE SPECIFIC, PURPOSE-DRIVEN STORAGE SOLUTIONS FOR THAT UNIQUE GEAR YOU TAKE AFIELD DURING ALL SEASONS. YOUR PURSUIT OF HUNTING ADVENTURE AWAITS.**

**HYPA-LITE™ STALKER™  
SLING WITH SWIVELS**

- ULTRA DURABLE AND LIGHTWEIGHT HYPALON CONSTRUCTION
- MOLDED LOW DENSITY FOAM WITH NON-SLIP TEXTURED BACKING
- WINDICATOR AND DIAPHRAGM CALL POCKETS
- SPARE SHELL LOOPS
- ADJUSTABLE LADDER LOCK BUCKLE
- D-RINGS TO ATTACH ACCESSORIES
- SWIVELS TESTED TO OVER 500LBS

MO MOUNTAIN COUNTRY  
**8690 \ 6 PK \ 026509026747**



**HYPA-LITE™ SHOCKER™  
TURKEY SLING WITH SWIVELS**

- ULTRA DURABLE AND LIGHTWEIGHT HYPALON CONSTRUCTION
- MOLDED LOW DENSITY FOAM
- NON-SLIP TEXTURED BACKING
- COVERED MOUTH CALL STORAGE POCKET
- SPARE SHELL LOOPS
- ADJUSTABLE LADDER LOCK BUCKLE
- SWIVELS TESTED TO OVER 500LBS

MO OBSESSION NWTF  
**8686 \ 6 PK \ 026509021841**



**HYPA-LITE™ PUNISHER™  
WATERFOWL SLING WITH SWIVELS**

- HYPALON CONSTRUCTION
- ULTRA DURABLE AND LIGHTWEIGHT
- MOLDED LOW DENSITY FOAM
- NON-SLIP TEXTURED BACKING
- SPARE CALL STORAGE POCKET
- SPARE SHELL LOOPS
- ADJUSTABLE LADDER LOCK BUCKLE
- D-RINGS TO ATTACH ACCESSORIES
- SWIVELS TESTED TO OVER 500LBS

RT MAX-5  
**8687 \ 6 PK \ 026509022374**



**HYPA-LITE™ BRUISER™  
DEER SLING WITH SWIVELS**

- ULTRA DURABLE AND LIGHTWEIGHT HYPALON CONSTRUCTION
- MOLDED LOW DENSITY FOAM
- NON-SLIP TEXTURED BACKING
- STRETCH MESH POCKET FOR WINDICATOR BOTTLE OR GRUNT CALL
- POCKET FOR LENS CLEANING CLOTH
- ADJUSTABLE LADDER LOCK BUCKLE
- D-RINGS TO ATTACH ACCESSORIES
- SWIVELS TESTED TO OVER 500LBS

MO BU COUNTRY  
**8688 \ 6 PK \ 026509022381**





**SWIVELS TESTED TO OVER 500LBS. (226KG)**



**BIGHORN RUBBER SLING**

- LIGHTWEIGHT RUBBER
- RUBBER-FORM GRIP
- LIGHTWEIGHT AND TACKY BACKING
- SWIVELS TESTED TO 500LBS

CHARCOAL PAD, BLACK WEB  
**8421 \ 6 PK \ 026509010098**



**RUGER® BOULDER RUBBER SLING WITH SWIVELS**

- LIGHTWEIGHT AND TACKY BACKING
- 1IN HEAVY WEIGHT POLYESTER WEBBING
- SWIVELS TESTED TO 500LBS

BLACK/RED  
**27600 \ 6 PK \ 026509043027**

**COBRA PADDED LEATHER RIFLE SLING**

- FULL GRAIN LEATHER FACE
- SUEDE LINING
- DESIGNED FOR ONE HAND ADJUSTMENT
- SWIVELS TESTED TO 500LBS

**8145 \ 3 PK \ 026509081456**

**BIG GAME SUEDE RIFLE SLING**

- SUEDE LEATHER FRONT AND BACK
- FOR HEAVY-DUTY USE
- SWIVELS TESTED TO 500LBS

**8140 \ 3 PK \ 026509081401**



**RUGER® MESA NEOPRENE SLING WITH SWIVELS**

- STRETCHABLE NEOPRENE BODY FOR ADDED COMFORT
- ELASTIC CENTER SECTION TO REDUCE STRETCH
- STICKY BACK REDUCES SLIP
- SWIVELS TESTED TO 500LBS

**27834 \ 6 PK \ 026509018148**



**RUGER® SUMMIT ULTRALITE SLING**

- LOW-DENSITY FOAM COVERED BY RUGGED FABRIC
- NON-SLIP TEXTURED BACK
- HEAVY-DUTY WEB SLING
- SWIVELS TESTED TO 500LBS

BLACK  
**27830 \ 6 PK \ 026509010111**



**RUGER® PADDED SLING 10/22® WITH SWIVELS**

- LIGHTWEIGHT SLING
- SHOULDER PAD WITH GRIPPING SURFACE
- 1IN WEB STRAP
- SWIVELS TESTED TO 500LBS

BLACK/GREY  
**27602 \ 6 PK \ 026509043058**

**NEW**

**CIRRUS ULTRALIGHT RUBBER SLING**

- ULTRA SLIM FORMAT MINIMIZES WEIGHT WITHOUT SACRIFICING COMFORT
- COMFORTABLE RUBBER SHOULDER PAD CONFORMS TO SHOULDER
- SAVES WEIGHT FOR LONG DISTANCES AND STEEP INCLINES
- SWIVELS TESTED TO 500LBS

BLACK/GRAY  
8502 \ 4 PK \ 026509060642



**NEW**

**GIRLS WITH GUNS® BLACK LABEL RIFLE SLING**

- LIGHTWEIGHT AND TACKY BACKING
- 1IN HEAVY WEIGHT POLYESTER WEBBING
- SWIVELS TESTED TO 500LBS

BLACKOUT SHADE™ CAMO  
8274 \ 4 PK \ 026509062653



**GIRLS WITH GUNS® GLENWOOD RIFLE SLING**

- LIGHTWEIGHT CONSTRUCTION
- LOW DENSITY MOLDED FOAM
- NON-SLIP, TEXTURED BACK
- SWIVELS TESTED TO 500LBS

SHADE™ CAMO  
8484 \ 6 PK \ 026509008095



**GIRLS WITH GUNS® HIGH COUNTRY RIFLE SLING**

- ULTRA DURABLE AND LIGHTWEIGHT
- HEAVY-DUTY WEB CONSTRUCTION
- MOLDED LOW DENSITY FOAM
- NON-SLIP TEXTURED BACKING
- SWIVELS TESTED TO OVER 500LBS

SHADE™ CAMO  
8485 \ 6 PK \ 026509008439



**NEW**

**GIRLS WITH GUNS® MIDNIGHT RIFLE SLING**

- HEAVY-DUTY NEOPRENE SLING
- RUGGED SPANDEX BINDING LASTS OVER TIME
- SWIVELS TESTED TO 500LBS

BLACKOUT SHADE™ CAMO  
8272 \ 4 PK \ 026509062646



**CASCADE NEOPRENE SLING**

- HEAVY-DUTY NEOPRENE SLING
- RUGGED SPANDEX BINDING LASTS OVER TIME
- SWIVELS TESTED TO 500LBS

RT XTRA  
8216 \ 6 PK \ 026509082163

BLACK  
8211 \ 6 PK \ 026509082118







SWIVELS TESTED TO OVER 500LBS. (226KG)



### YUKON NEOPRENE RIFLE SLING

- FOUR ELASTIC RIFLE CARTRIDGE LOOPS
- HEAVY-DUTY WEB CONSTRUCTION
- NEOPRENE SHOULDER PAD CUSHIONING
- SWIVELS TESTED TO 500LBS

MO BU COUNTRY

8293 \ 6 PK \ 026509082934

### DENALI NEOPRENE CARTRIDGE SLING

- FIVE CARTRIDGE LOOPS
- SLIP PROOF "SHARKSKIN" BACK
- CUSHIONING EFFECT OF NEOPRENE
- SWIVELS TESTED TO 500LBS

BLACK

8888 \ 6 PK \ 026509088882



### HIGH COUNTRY ULTRALITE MOLDED SLING

- VERY LIGHTWEIGHT LOW DENSITY FOAM
- FORMS TO THE SHOULDER
- SWIVELS TESTED TO 500LBS

MO BU COUNTRY

8263 \ 6 PK \ 026509082637



### GLENWOOD LIGHTWEIGHT SLING

- LIGHTWEIGHT CONSTRUCTION
- LOW DENSITY MOLDED FOAM
- NON-SLIP, TEXTURED BACK
- SWIVELS TESTED TO 500LBS

BLACK

8284 \ 6 PK \ 026509008354

MO BU COUNTRY

8287 \ 6 PK \ 026509008385



### GUNNISON NEOPRENE SLING

- HEAVY-DUTY 1IN WEBBING
- NON-SLIP NEOPRENE SHOULDER PAD
- FULLY ADJUSTABLE
- SWIVELS TESTED TO 500LBS

MO BU COUNTRY

8366 \ 6 PK \ 026509083665

BLACK

8368 \ 6 PK \ 026509083689



### RUGER® 10\22® RIFLE SLING

- HEAVY-DUTY 1.25IN WEB CONSTRUCTION
- ADJUSTABLE BUCKLE SLIDES TO FIT MOST RIFLES
- SWIVELS TESTED TO 500 POUNDS

BLACK

27838 \ 6 PK \ 026509278382

**STRETCH BLACK PARACORD SLING**

- NEW MATERIALS ADD COMFORT TO THE STANDARD PARACORD DESIGN
- ELASTIC ADDS A CUSHIONING EFFECT
- HEAVY-DUTY SWIVELS AND HARDWARE
- SWIVELS TESTED TO 500LBS

BLACK\*  
8913 \ 6 PK \ 026509035152



**QUICK ADJUSTING RIFLE SLING**

- 1.25IN WIDE WEB SLING
- SWIVELS TESTED TO 500LBS

BLACK  
8061 \ 6 PK \ 026509080619



**SLIDE & LOCK BLACK WEB SLING**

- SPECIAL BUCKLE THAT ALLOWS SLING TO BE ADJUSTED INSTANTLY
- HEAVY WEB CONSTRUCTION
- SWIVELS TESTED TO 500LBS

BLACK  
8451 \ 6 PK \ 026509084518



**STANDARD PADDED SLING**

- LIGHT WEIGHT
- ENDURA COVERED FOAM PADDING
- 1IN WEBBING CONNECTION STRAP
- SWIVELS TESTED TO 500LBS

TAN  
8490 \ 6 PK \ 026509017523



**STANDARD ENDURA RIFLE SLING**

- 3\8IN FOAM PADDING
- COVERED WITH RUGGED ENDURA FABRIC
- HEAVY WEB CONSTRUCTION
- SWIVELS TESTED TO 500LBS

BLACK  
8311 \ 6 PK \ 026509083115  
MO BU COUNTRY  
83004 \ 6 PK \ 026509830047



**SLINGS THAT DO NOT HAVE SWIVELS**

**STANDARD ENDURA SLING**

- 3\8IN FOAM PADDING • RUGGED ENDURA FABRIC
- HEAVY-DUTY WEB CONSTRUCTION

SHOTGUN\MO BU COUNTRY  
82003 \ 6 PK \ 026509820031  
RIFLE\BLACK  
85 \ 6 PK \ 026509000853  
RIFLE\MO BU COUNTRY  
83003 \ 6 PK \ 026509830030

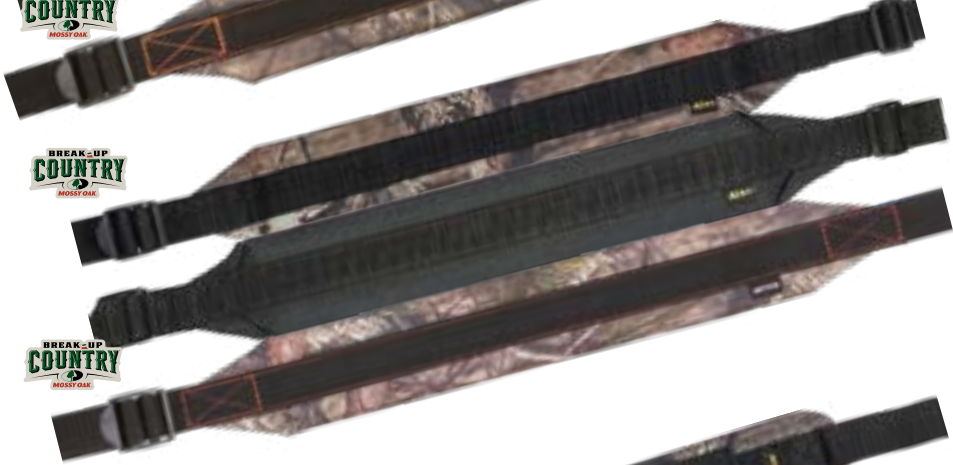

**YUKON NEOPRENE SLING W\ RIFLE CARTRIDGE LOOPS**

- NEOPRENE PAD WITH NON-SLIP BACK
- FOUR ELASTIC SHELL HOLDING LOOPS
- THUMB RING LOOP

RIFLE\MO BU COUNTRY  
8103 \ 6 PK \ 026509081036



**YUKON NEOPRENE SLING W\ SHOTGUN SHELL LOOPS**

- NEOPRENE PAD WITH NON-SLIP BACK
- FOUR ELASTIC SHELL HOLDING LOOPS
- HEAVY-DUTY WEB CONSTRUCTION

SHOTGUN\MO BU COUNTRY  
8003 \ 6 PK \ 026509080039





**STRONGER  
THAN THE  
COMPETITION**

**AVERAGE LOAD  
STRENGTH  
501 LBS\***

\*TESTED BY INDEPENDENT EXPERTS

**COMPETITOR BRANDS**



**SREAKS  
AT 390 LBS**



**SREAKS  
AT 294 LBS**



**SREAKS  
AT 412 LBS**



**TACTICAL SWIVELS &  
RAIL MOUNT  
AVAILABLE P. 105**



**MAGNUM SWIVEL SET**

- CAST SWIVEL SET TESTED TO OVER 500LBS
  - LOCKING SCREW TO PROVIDE SOLID ATTACHMENT FOR SLINGS DESIGNED FOR SLINGS 1IN WIDE
- 14510 \ 6 PK \ 026509145103**  
DESIGNED FOR SLINGS 1-1\4IN WIDE  
**14512 \ 6 PK \ 026509145127**



**SWIVEL SET FOR PUMP AND SEMI-AUTO  
SHOTGUNS: DESIGNED FOR SLINGS 1IN WIDE**

- SWIVEL SET FITS MOST PUMP AND SEMI-AUTO SHOTGUNS WITHOUT HARDWARE INSTALLED
- CONTAINS NECESSARY HARDWARE TO INSTALL SWIVELS ON MOST PUMP ACTION AND SEMI-AUTOMATIC SHOTGUNS. A THREADED STUD DESIGNED FOR INSTALLING INTO WOOD OR SYNTHETIC STOCKS IS INCLUDED FOR THE BUTTSTOCK ATTACHMENT. A ROTATING STUD THAT REQUIRES DRILLING THE FACTORY MAGAZINE TUBE CAP IS INCLUDED FOR ATTACHING TO THE FOREND.

**14430 \ 6 PK \ 026509144304**



**SWIVEL SET FOR RUGER® RIFLES WITH BARREL  
BANDS: DESIGNED FOR SLINGS 1IN WIDE**

- SWIVEL SET FITS RUGER® 10\22®, RUGER® MINI-THIRTY®, RUGER® MINI-14® ETC. WITHOUT HARDWARE INSTALLED
- CONTAINS NECESSARY HARDWARE TO INSTALL SWIVELS ON RUGER® RIFLES WITH BARREL BANDS. A THREADED STUD DESIGNED FOR INSTALLING INTO WOOD OR SYNTHETIC STOCKS IS INCLUDED FOR THE BUTTSTOCK ATTACHMENT. A SPECIALLY DESIGNED FOREND STUD THAT MATES WITH THE BARREL BAND IS INCLUDED.

**14450 \ 6 PK \ 026509144502**



**SWIVEL SET FOR BOLT ACTION RIFLES:  
DESIGNED FOR SLINGS 1IN WIDE**

- SWIVEL SET FOR BOLT ACTION RIFLES WITHOUT HARDWARE INSTALLED
- CONTAINS HARDWARE TO INSTALL SWIVELS INTO MOST BOLT ACTION RIFLES
- DESIGNED TO WORK WITH WOOD OR SYNTHETIC STOCK. ADDITIONAL THREADED SCREW AND NUT ARE INCLUDED FOR A SECURE CONNECTION IN STOCKS WITH THIN WOOD WALLS OR HOLLOW SYNTHETIC STOCKS.

**14420 \ 6 PK \ 026509144205**



**SLING SWIVEL MOUNTING HARDWARE  
FOR BOLT ACTION RIFLES**

- END SCREW FOR WOOD OR SCREW AND NUT
- WOOD SCREW FOR BUTTSTOCK WITH WHITE SPACER
- COMPLETE ILLUSTRATED INSTRUCTIONS

**14424 \ 6 PK \ 026509144243**





# RACK 'EM

SEE YOUR  
SALES REP  
FOR FULL TARGET  
RACK PROGRAMS

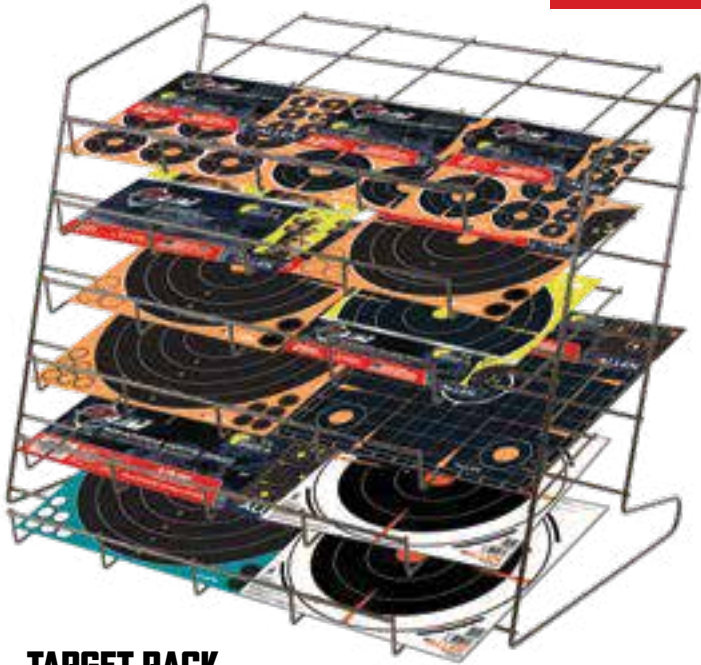

## TARGET RACK

• 19IN HEIGHT X 22IN WIDTH X 19IN DEPTH

153391

### RACK INCLUDES:

- 12-MODEL 15318 SPLASH 2IN BULLSEYE
- 12-MODEL 15326 SPLASH 3IN BULLSEYE
- 12-MODEL 15254 SPLASH BULLSEYE VARIETY PACK
- 12-MODEL 15317 SPLASH 1IN BULLSEYE
- 12-MODEL 15316 SPLASH 8IN BULLSEYE 6PK
- 12-MODEL 15314 SPLASH 12IN SIGHT-IN GRID
- 6-MODEL SPLASH 8IN BULLSEYE 30PK
- 12-MODEL 15213 SPLASH 8IN BULLSEYE
- 12-MODEL 15211 SPLASH 12IN SIGHT-IN
- 12-MODEL 15264 SPLASH PRAIRIE DOG
- 12-MODEL 15279 SPLASH GWG 12IN BULLSEYE
- 12-MODEL 15333 PAPER SIGHT-IN
- 12-MODEL 15246 PAPER 8IN BULLSEYE



## TARGET FLOOR DISPLAY - 2FT

• 54IN HEIGHT X 31IN WIDTH X 18IN DEPTH

153351

### FLOOR DISPLAY INCLUDES:

- 12-MODEL 15318 SPLASH 2IN BULLSEYE
- 12-MODEL 15326 SPLASH 3IN BULLSEYE
- 12-MODEL 15254 SPLASH BULLSEYE VARIETY PACK
- 12-MODEL 15255 SPLASH 6IN BULLSEYE
- 12-MODEL 15316 SPLASH 8IN BULLSEYE 6PK
- 6-MODEL 15221 SPLASH 8IN BULLSEYE 30PK
- 12-MODEL 15301 SPLASH 8IN SIGHT IN GRID
- 12-MODEL 15264 SPLASH PRAIRIE DOG
- 12-MODEL 15317 SPLASH 12IN BULLSEYE
- 12-MODEL 15314 SPLASH 12IN SIGHT IN GRID
- 12-MODEL 15227 SPLASH 16IN BULLSEYE
- 12-MODEL 15279 SPLASH GWG 12IN BULLSEYE

# TARGET RACKS AND TARGET PADS



**NEW**

**EZ AIM<sup>®</sup> SPLASH REACTIVE SILHOUETTE TRAINER TARGET PAD**  
**12.5in x 18.25in, 30 PACK**

• EASY PEEL AWAY TARGET PAD - 30 TARGETS/PAD  
**15372-30 \ 6 PK \ 026509062110**

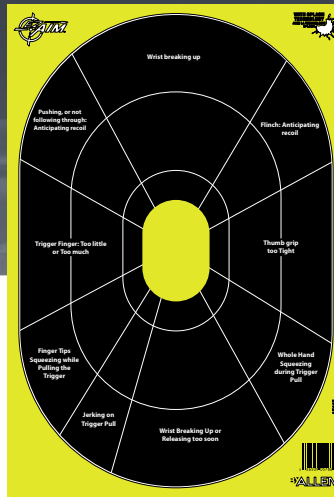

**NEW**

**EZ AIM<sup>®</sup> SPLASH REACTIVE HANDGUN TRAINER TARGET PAD**  
**12.5in x 18.25in, 30 PACK**

• EASY PEEL AWAY TARGET PAD - 30 TARGETS/PAD  
**15220-30 \ 6 PK \ 026509065494**

WITH SPLASH TECHNOLOGY



**TARGET PADS**

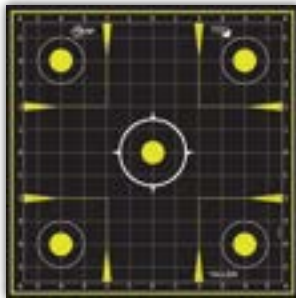

**NEW**

**EZ AIM<sup>®</sup> SPLASH REACTIVE 12.5in x 12.5in SIGHT GRID TARGET PAD, 30 PACK**

• EASY PEEL AWAY TARGET PAD - 30 TARGETS/PAD  
**15211-30 \ 6 PK \ 026509062165**



**NEW**

**EZ AIM<sup>®</sup> SPLASH REACTIVE 12.5in x 12.5in BULLSEYE TARGET PAD, 30 PACK**

• EASY PEEL AWAY TARGET PAD - 30 TARGETS/PAD  
**15214-30 \ 6 PK \ 026509062134**



**NEW**

**EZ AIM<sup>®</sup> PAPER IPSC 1/2 SIZE TARGET 12in x 18in, 50 PACK**

• HALF-SIZE IPSC TARGET  
 • PAD HAS BINDING FOR EASY HANDLING  
**15551-50 \ 12 PK \ 026509062042**



**NEW**

**EZ AIM<sup>®</sup> PAPER 12in x 12in BULLSEYE TARGET PAD, 100 PACK**

• BULLSEYE IS ONE INCH DIAMETER  
 • SCOPE ALIGNER HASH MARKS  
**15334-100 \ 12 PK \ 026509062028**

**BULK PACK SIZES - GREAT FOR RANGES**

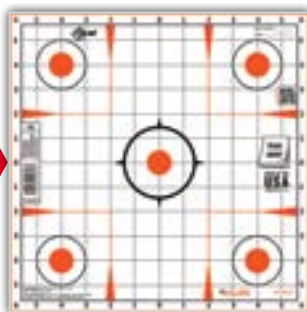

**NEW**

**EZ AIM<sup>®</sup> PAPER 12in x 12in SIGHT GRID TARGET PAD, 100 PACK**

• GRID MAKES SCOPE ADJUSTING EASIER  
 • ONE INCH GRID PATTERN  
**15333-100 \ 12 PK \ 026509062011**





# PULL-N-SHOOT TARGET DISPENSERS



**EZ AIM® PULL-N-SHOOT  
SPLASH REACTIVE  
SIGHT-IN GRID TARGET ROLL**  
12IN X 12IN, 8 PIECES PER PACK  
• PAPER DIMENSIONS: 12IN X 12.25IN  
15257 \ 4 PK \ 026509046660

**EZ AIM® PULL-N-SHOOT  
SPLASH REACTIVE  
HANDGUN TRAINER TARGET ROLL**  
12IN X 12IN, 8 PIECES PER PACK  
• PAPER DIMENSIONS: 12IN X 12.25IN  
15258 \ 4 PK \ 026509046677

**EZ AIM® PULL-N-SHOOT  
SPLASH REACTIVE  
BULLSEYE TARGET ROLL**  
12IN X 12IN, 8 PIECES PER PACK  
• PAPER DIMENSIONS: 12IN X 12.25IN  
15256 \ 4 PK \ 026509046653

## REFLECTIVE SPLASH!

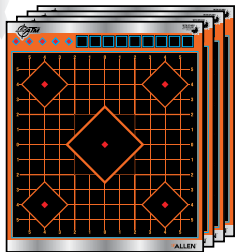

**EZ AIM® REFLECTIVE  
SPLASH ADHESIVE  
SIGHT-IN TARGET**  
9IN X 9IN, 4 PACK  
• PAPER DIMENSIONS: 9.5IN X 10.9IN  
15233 \ 12 PK \ 026509035664

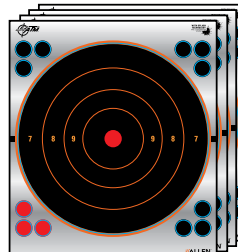

**EZ AIM® REFLECTIVE  
SPLASH ADHESIVE  
BULLSEYE TARGET**  
9IN X 9IN, 6 PACK  
• PAPER DIMENSIONS: 9.5IN X 10.9IN  
15232 \ 12 PK \ 026509035695

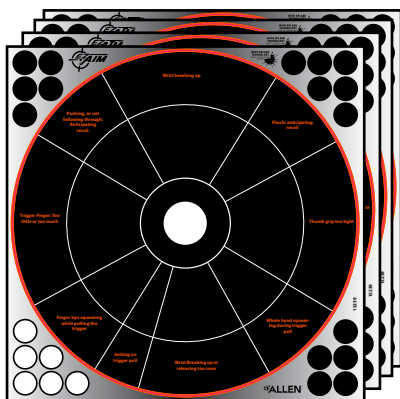

**EZ AIM® REFLECTIVE SPLASH  
ADHESIVE HANDGUN TRAINER**  
12IN X 12IN, 4 PACK  
• PAPER DIMENSIONS: 12.5IN X 12.5IN  
15239 \ 12 PK \ 026509046592

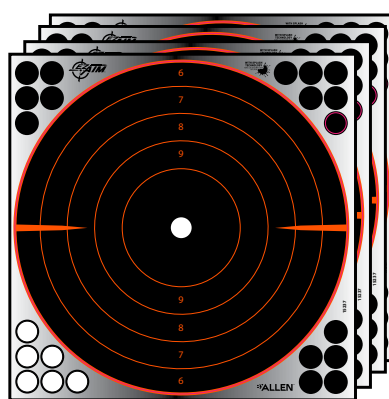

**EZ AIM® REFLECTIVE SPLASH  
ADHESIVE BULLSEYE**  
12IN X 12IN, 4 PACK  
• PAPER DIMENSIONS: 12.5IN X 12.5IN  
15237 \ 12 PK \ 026509046578

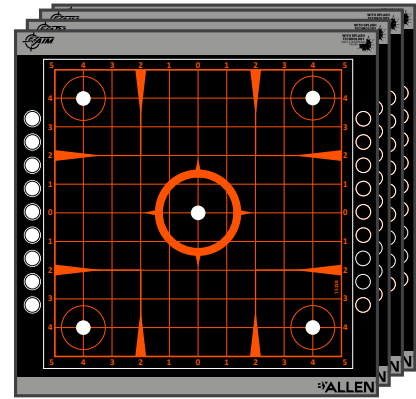

**EZ AIM® REFLECTIVE SPLASH  
ADHESIVE SIGHT-IN GRID**  
12IN X 12IN, 4 PACK  
• PAPER DIMENSIONS: 12.5IN X 12.5IN  
15238 \ 12 PK \ 026509046585





**NEW**

**EZ AIM® COROPLAST IPSC SILHOUETTE 18IN X 30IN WHITE, SINGLE PACK**

- OFFICIAL SIZE
- DOTTED LINE SHOWING CENTER OF MASS

15575 \ 12 PK \ 026509062523

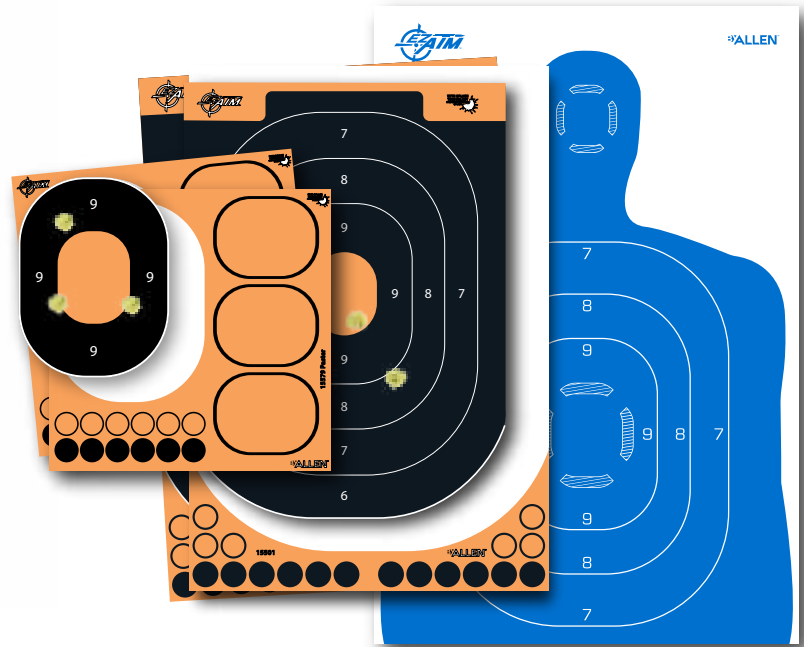

**NEW**

**EZ AIM® SILHOUETTE KIT: 23IN X 35IN WITH REPLACEABLE TARGETS**

- 23IN X 35IN BACKER WITH SILHOUETTE PRINTED
- 2 EACH 12IN X 18IN IPSC TARGETS
- 6 EACH 10 RING REPLACEMENT TARGETS
- TWO EACH 9 + 10 RING REPLACEMENTS
- 36 PASTERS TO COVER BULLET HOLES

15579 \ 12 PK \ 026509062561

**TARGET KITS**



**EZ AIM® ADHESIVE SPLASH SILHOUETTE TARGET KIT**

**6IN X 6IN**

- PAPER DIMENSIONS: 6.5IN X 6.5IN
- INCLUDES 6 ADHESIVE TARGETS

15379 \ 12 PK \ 026509053682

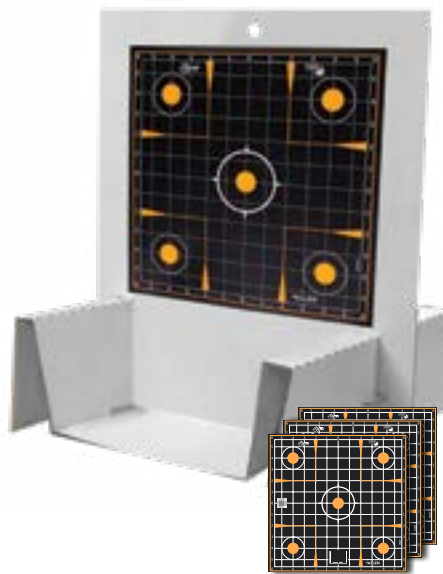

**EZ AIM® ADHESIVE SPLASH SIGHT-IN KIT 12IN X 12IN**

- PAPER DIMENSIONS: 12.5IN X 12.5IN
- INCLUDES 3 ADHESIVE TARGETS

15378 \ 12 PK \ 026509053675



**NEW**

**EZ AIM® ADHESIVE SPLASH HANDGUN TRAINING KIT, 14IN X 22IN WITH STAND**

- 2 EACH 12IN X 18IN HANDGUN TRAINER TARGETS
- 2 EACH REPLACEMENT CENTER OF MASS PASTERS
- 6 EACH 10-RING REPLACEMENT PASTERS
- 60 BULLET HOLE COVERS

15548 \ 12 PK \ 026509063117



# ADHESIVE SPLASH REACTIVE TARGETS

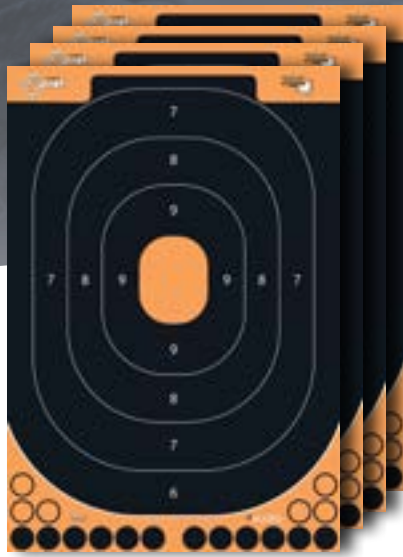

**NEW**

## EZ AIM<sup>®</sup> ADHESIVE SPLASH REACTIVE SILHOUETTE 12in x 18in, 100 PACK

- SPLASH TECHNOLOGY FOR VISIBLE IMPACT
  - 12.5IN X 18.25IN TARGET SURFACE
  - ADHESIVE BACK STICKS TO BACKSTOPS
- 15306 \ 1 PK \ 026509051381

## EZ AIM<sup>®</sup> ADHESIVE SPLASH REACTIVE SILHOUETTE TRAINING TARGET 12in x 18in

- SPLASH TECHNOLOGY FOR VISIBLE IMPACT
- 12.5 X 18.25 INCH TARGET SURFACE

TRAINING TARGET 12IN X 18IN / 5 PACK

15501 \ 12 PK \ 026509062530

**NEW**

TRAINING TARGET 12IN X 18IN / 10 PACK

15501-10 \ 12 PK \ 026509064596

TRAINING TARGET 12IN X 18IN / 25 PACK

15501-25 \ 6 PK \ 026509063124

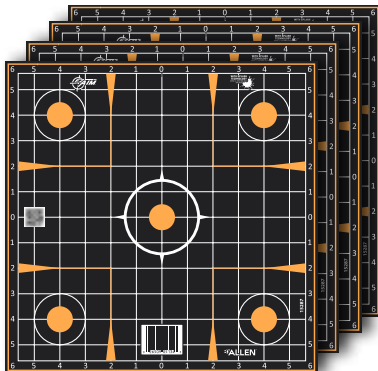

## EZ AIM<sup>®</sup> ADHESIVE SPLASH REACTIVE 12in x 12in BULLSEYE

- DESIGNED TO MAXIMIZE ACCURACY
- SEE YOUR SHOTS IMPACT
- FLAKING PAPER AND SPLASH TECHNOLOGY
- SHOW BRIGHT YELLOW IMPACT HOLES
- ADHESIVE BACKED STICKS TO MOST CARDBOARD, PLYWOOD, OR STEEL TARGET

ADHESIVE SPLASH 12IN BULLSEYE / 5 PACK

15317 \ 12 PK \ 026509048060

**NEW**

ADHESIVE SPLASH 12IN BULLSEYE / 10 PACK

15317-10 \ 12 PK \ 026509062196

ADHESIVE SPLASH 12IN BULLSEYE / 25 PACK

15317-25 \ 6 PK \ 026509062226

ADHESIVE SPLASH 12IN BULLSEYE / 100 PACK

15305 \ 1 PK \ 026509051374

## EZ AIM<sup>®</sup> ADHESIVE SPLASH REACTIVE SIGHT-IN GRID 12in x 12in

- PAPER DIMENSIONS: 12.5 X 12.5
- 1" GRID MAKES SCOPE ADJUSTING EASIER
- SPLASH TECHNOLOGY

SIGHT-IN GRID 12IN X 12IN, 5 PACK

15314 \ 12 PK \ 026509048046

**NEW**

SIGHT-IN GRID 12IN X 12IN, 10 PACK

15314-10 \ 12 PK \ 026509062189

SIGHT-IN GRID 12IN X 12IN, 100 PACK

15287 \ 1 PK \ 026509051343

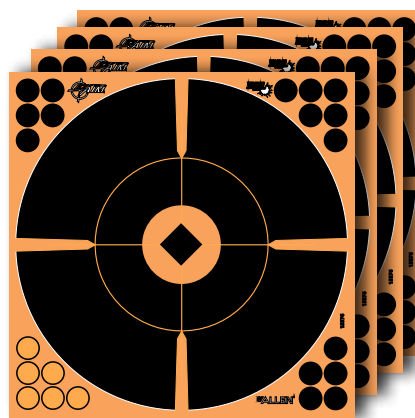

## EZ AIM<sup>®</sup> ADHESIVE SPLASH REACTIVE BULLSEYE WITH CROSSHAIR RECTICLE 12in x 12in, 5 PACK

- PAPER DIMENSIONS: 12.5IN X 12.5IN
- 15376 \ 12 PK \ 026509053651

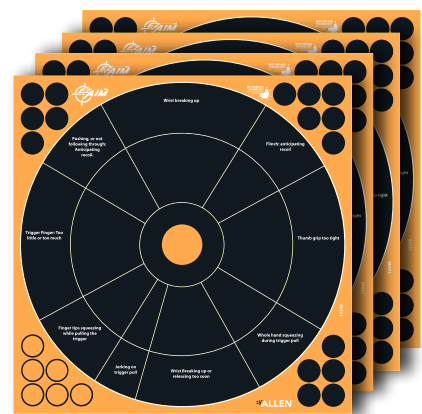

## EZ AIM<sup>®</sup> ADHESIVE SPLASH REACTIVE HANDGUN TRAINER 12in x 12in, 5 PACK

- PAPER DIMENSIONS: 12.5IN X 12.5IN
- 15248 \ 12 PK \ 026509046714



WITH SPLASH TECHNOLOGY

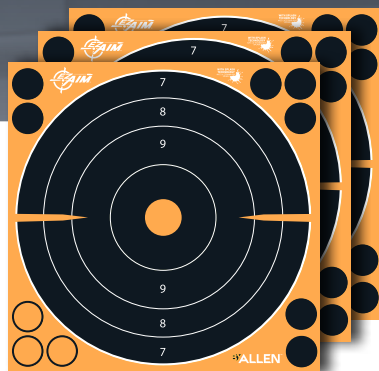
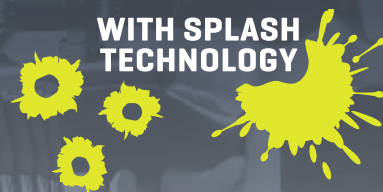

**EZ AIM<sup>®</sup> ADHESIVE SPLASH REACTIVE BULLSEYE 8in x 8in**

- PAPER DIMENSIONS: 8.5IN X 8.5IN
- BULLSEYE 8IN X 8IN, 6 PACK
- 15316 \ 12 PK \ 026509048053**
- BULLSEYE 8IN X 8IN, 30 PACK
- 15221 \ 12 PK \ 026509046448**

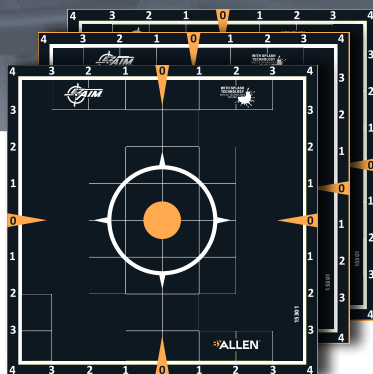

**EZ AIM<sup>®</sup> ADHESIVE SPLASH REACTIVE SIGHT-IN GRID 8in x 8in, 6 PACK**

- PAPER DIMENSIONS: 12.5IN X 12.5IN
- GRID MAKES SCOPE ADJUSTING EASIER
- SPLASH TECHNOLOGY
- ONE INCH GRID PATTERN
- 15301 \ 12 PK \ 026509048947**



**EZ AIM<sup>®</sup> ADHESIVE SPLASH REACTIVE BULLSEYE 17in x 17in, 5 PACK**

- PAPER DIMENSIONS: 17.25IN X 17.25IN
- 15227 \ 12 PK \ 026509046455**



**EZ AIM<sup>®</sup> ADHESIVE SPLASH REACTIVE BULLSEYE 6in x 6in, 12 PACK**

- PAPER DIMENSIONS: 6.5IN X 6.5IN
- 15255 \ 12 PK \ 026509046486**



**EZ AIM<sup>®</sup> ADHESIVE SPLASH REACTIVE 3in BULLSEYE 12 SHEETS, 48 PIECES**

- PAPER DIMENSIONS: 6.5IN X 6.5IN
- 15326 \ 12 PK \ 026509048084**



**EZ AIM<sup>®</sup> ADHESIVE SPLASH REACTIVE 2in BULLSEYE, 12 SHEETS, 6in x 6in**

- 108 PIECES
- PAPER DIMENSIONS: 6.5IN X 6.5IN
- 15318 \ 12 PK \ 026509048077**

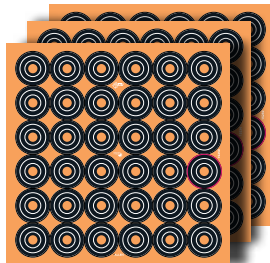

**EZ AIM<sup>®</sup> ADHESIVE SPLASH REACTIVE 1in BULLSEYE VARIETY PACK, 12 SHEETS, 6in x 6in**

- 432 PIECES
- PAPER DIMENSIONS: 6.5IN X 6.5IN
- 15250 \ 12 PK \ 026509046462**



**EZ AIM<sup>®</sup> ADHESIVE SPLASH REACTIVE BULLSEYE VARIETY PACK, 12 SHEETS, 6in x 6in**

- 1IN-72 / 2IN-36 / 3IN-24
- PAPER DIMENSIONS: 6.5IN X 6.5IN
- 15254 \ 12 PK \ 026509046479**



**GIRLS WITH GUNS<sup>®</sup>  
ADHESIVE SPLASH REACTIVE  
HANDGUN TRAINER**

**12IN X 18IN, 5 PACK**

• PAPER DIMENSIONS: 12.5IN X 18.25IN

**15283 \ 12 PK \ 026509046813**

**PRO TIPS  
PRINTED ON  
EACH TARGET**

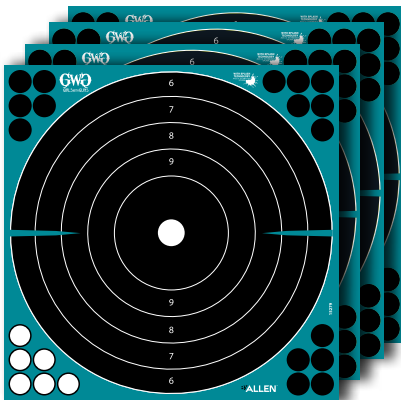
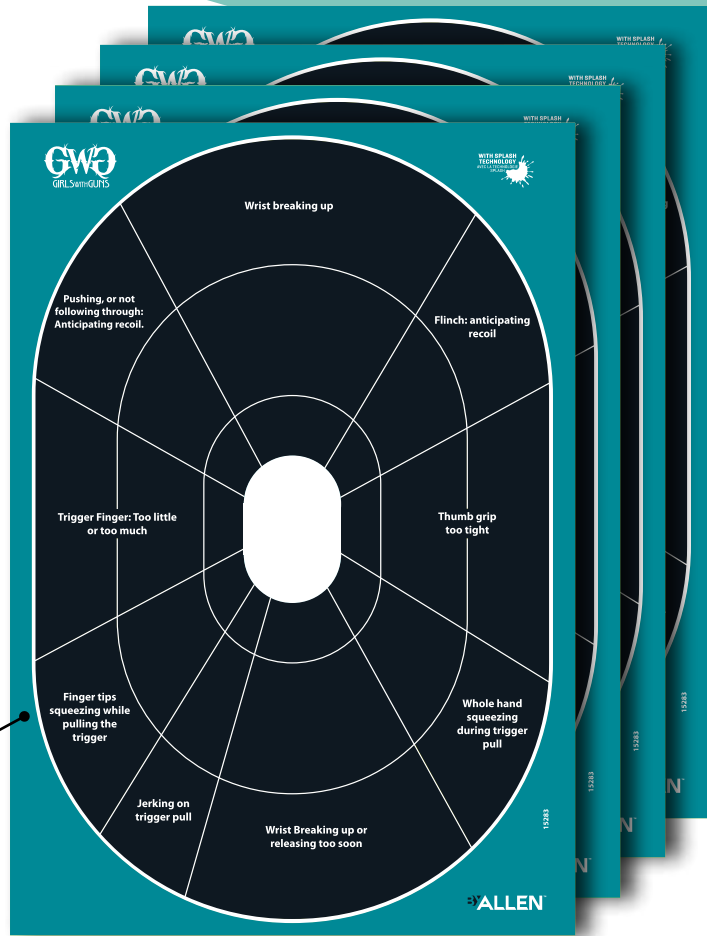

**GIRLS WITH GUNS<sup>®</sup> ADHESIVE  
SPLASH REACTIVE BULLSEYE**

• PAPER DIMENSIONS: 12.5IN X 12.5IN

**15279 \ 12 PK \ 026509046790**

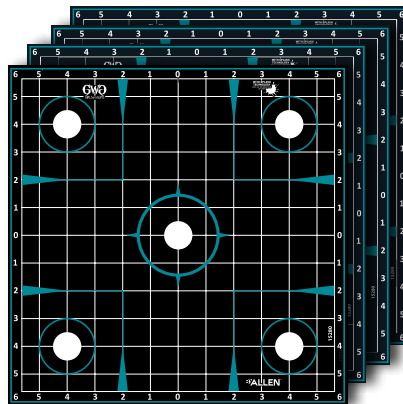

**GIRLS WITH GUNS<sup>®</sup> ADHESIVE  
SPLASH REACTIVE SIGHT-IN GRID**

• PAPER DIMENSIONS: 12.5IN X 12.5IN

**15280 \ 12 PK \ 026509046806**



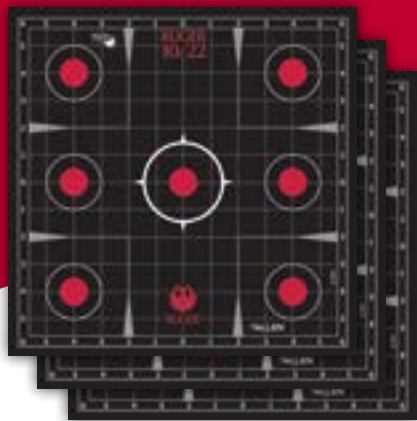

**NEW**

**RUGER® 10/22® ADHESIVE SPLASH REACTIVE TARGETS 12.5IN X 12.5IN, 5 PACK**

- GREAT FOR PLINKING OR SIGHT-IN
- ADHESIVE BACK FOR EASY ATTACHMENT TO BACKSTOPS
- SEVEN, 1 INCH AIMING SPOTS
- GRID PATTERN FOR EASY SCOPE AND SIGHT ADJUSTMENTS
- 5 TARGETS PER PACK

12.5IN X 12.5IN TARGET SURFACE  
**27991 \ 12 PK \ 026509060901**



**NEW**

**RUGER® 10/22® ADHESIVE SPLASH REACTIVE TARGET KIT**

- SPLASH TECHNOLOGY FOR VISIBLE IMPACT
- 12.5IN X 12.5IN ADHESIVE TARGETS
- ADHESIVE BACK FOR EASY ATTACHMENT TO BACKSTOPS
- BULLET HOLES SHOW BRIGHT CHARTREUSE
- 3 TARGETS INCLUDED

12.5IN X 12.5IN TARGET SURFACE  
**28001 \ 12 PK \ 026509061663**

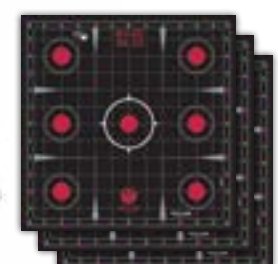

COMES WITH 3 ADHESIVE TARGETS



**NEW**

**RUGER® PAPER HANDGUN TRAINER TARGET 12IN X 18IN**

- 20 TARGETS PER PACK
- HANDGUN SHOOTING CORRECTIVE TIPS
- RED, BLACK AND WHITE PRINT
- 12IN X 18IN TARGET SURFACE

**27999 \ 12 PK \ 026509061656**



**NEW**

**RUGER® ADHESIVE SPLASH REACTIVE HANDGUN TRAINER 12IN X 18IN**

- SPLASH TECHNOLOGY FOR VISIBLE IMPACT
- ADHESIVE BACK FOR EASY INSTALLATION
- COACHING TIPS HELP CORRECT DELIVERY
- 12.5IN X 18.5IN SURFACE
- 5 TARGETS PER PACK

**27998 \ 12 PK \ 026509061649**

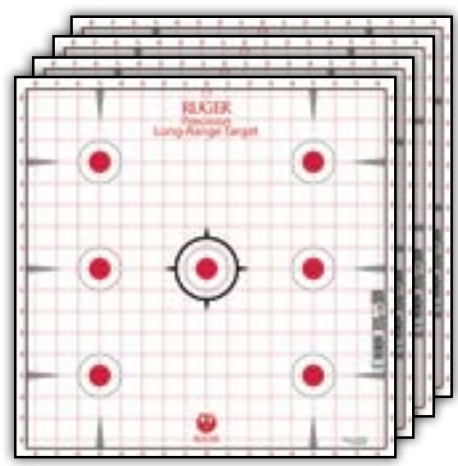

**NEW**

**RUGER® PAPER TARGET SEVEN SPOT PRECISION SIGHT-IN 17IN X 17IN**

- 20 TARGETS PER PACK
- ONE-INCH GRID PATTERN FOR SIGHT-IN
- SEVEN, ONE-INCH AIMING SPOTS
- 17IN X 17IN TARGET SURFACE

**27992 \ 12 PK \ 026509060918**



### EZ AIM SPLASH<sup>®</sup> REACTIVE PAPER PRAIRIE DOG 8in x 8in, 6 PACK

• PAPER DIMENSIONS: 8.5in X 8.5in  
15264 \ 12 PK \ 026509046738

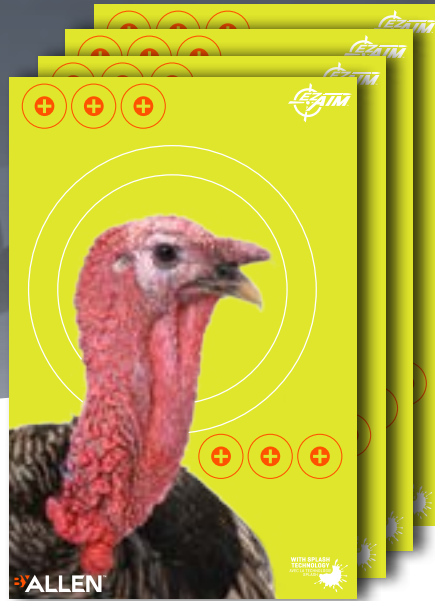

### EZ AIM SPLASH<sup>®</sup> REACTIVE PAPER TURKEY 12in x 18in, 8 PACK

• PAPER DIMENSIONS: 12in X 18in  
15267 \ 12 PK \ 026509046752



### EZ AIM SPLASH<sup>®</sup> REACTIVE PAPER IPSC SILHOUETTE 12in x 18in, 8 PACK

• PAPER DIMENSIONS: 12.5in X 18.25in  
15372 \ 12 PK \ 026509053613

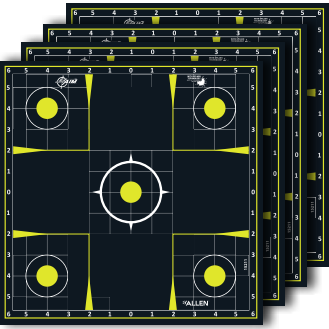

### EZ AIM SPLASH<sup>®</sup> REACTIVE PAPER SIGHT-IN GRID 12in x 12in, 12 PACK

• PAPER DIMENSIONS: 12.5in X 12.5in  
15211 \ 12 PK \ 026509046493



### EZ AIM SPLASH<sup>®</sup> REACTIVE PAPER BULLSEYE 12in x 12in, 12 PACK

• PAPER DIMENSIONS: 12.5in X 12.5in  
15214 \ 12 PK \ 026509046516



### EZ AIM SPLASH<sup>®</sup> REACTIVE PAPER 4 SPOT 12in x 12in, 12 PACK

• PAPER DIMENSIONS: 12.5in X 12.5in  
15218 \ 12 PK \ 026509046523



### EZ AIM SPLASH<sup>®</sup> REACTIVE PAPER BULLSEYE 8in x 8in, 25 PACK

• PAPER DIMENSIONS: 8.5in X 8.5in  
15213 \ 12 PK \ 026509046509

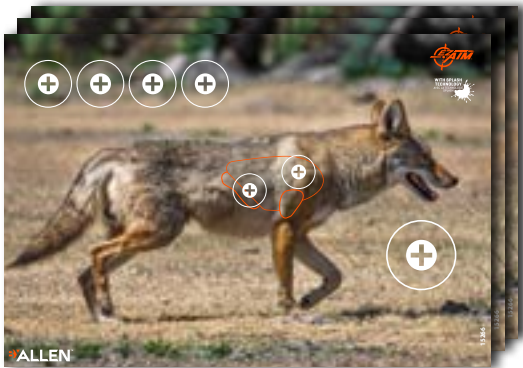

### EZ AIM SPLASH<sup>®</sup> REACTIVE PAPER COYOTE 12.75in x 24in, 3 PACK

• PAPER DIMENSIONS: 12.75in X 24in  
15266 \ 12 PK \ 026509046745

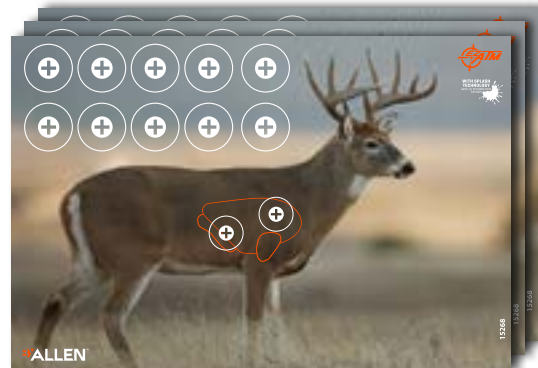

### EZ AIM SPLASH<sup>®</sup> REACTIVE PAPER WHITETAIL 12.75in x 24in, 3 PACK

• PAPER DIMENSIONS: 12.75in X 24in  
15268 \ 12 PK \ 026509046769





WITH SPLASH TECHNOLOGY



**EZ AIM SPLASH<sup>®</sup> REACTIVE PAPER BAD GUY**  
**12in x 18in, 5 PACK**  
 • PAPER DIMENSIONS: 12in X 18in  
**15249 \ 12 PK \ 026509046721**



**EZ AIM SPLASH<sup>®</sup> REACTIVE PAPER SILHOUETTE**  
**12in x 18in, 100 PACK**  
 • PAPER DIMENSIONS: 12in X 18in  
**15307 \ 1 PK \ 026509051398**



**NEW**  
**EZ AIM SPLASH<sup>®</sup> REACTIVE PAPER SHOOTING TARGETS, BULLSEYE**  
**12in x 12in, 12 PACK**  
 • PAPER DIMENSIONS: 12in X 12in  
**15577 \ 12 PK \ 026509062554**



**EZ AIM SPLASH<sup>®</sup> REACTIVE PAPER SILHOUETTE**  
**12in x 18in, 5 PACK**  
 • PAPER DIMENSIONS: 12in X 18in  
**15330 \ 12 PK \ 026509048107**

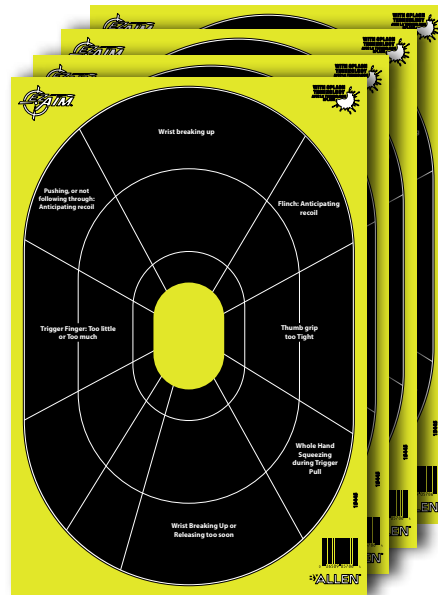

**NEW**  
**EZ AIM SPLASH<sup>®</sup> REACTIVE PAPER HANDGUN TRAINER**  
**12.5in x 18.25in, 100 PACK**  
 • PAPER DIMENSIONS: 12.5in X 18.25in  
**15445 \ 1 PK \ 026509057864**

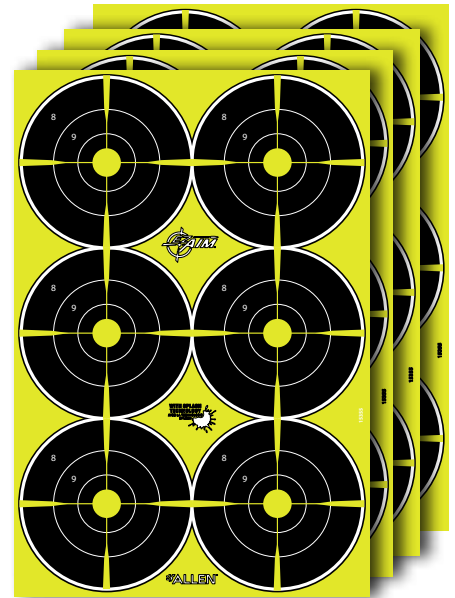

**NEW**  
**EZ AIM<sup>®</sup> EZ AIM SPLASH<sup>®</sup> REACTIVE PAPER 6in BULLSEYE, SIX-UP**  
**12.5in x 18.25in, 8 PACK**  
 • PAPER DIMENSIONS: 12.5in X 18.25in  
**15355 \ 12 PK \ 026509053606**

**EZ AIM SPLASH<sup>®</sup> REACTIVE PAPER HANDGUN TRAINER**  
**12in x 18in, 8 PACK**  
**15220 \ 12 PK \ 026509046547**

**EZ AIM SPLASH<sup>®</sup> REACTIVE PAPER 6 SPOT**  
**12in x 18in, 100 PACK**  
**15219 \ 1 PK \ 026509046530**

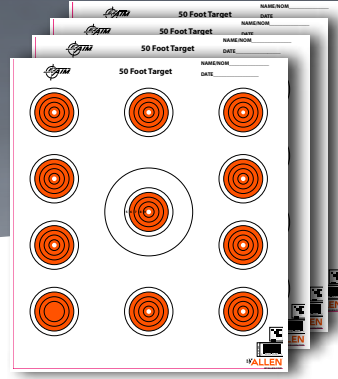

**NEW**

**EZ AIM® IBS RIMFIRE TARGET**

**14-IN X 17-IN, 25 PACK**

• PAPER DIMENSIONS: 14IN X 17IN  
15582 \ 12 PK \ 026509062592

**EZ AIM® PAPER 11 SPOT INDOOR**

**12-IN X 12-IN, 13 PACK**

• PAPER DIMENSIONS: 12IN X 12IN  
15245 \ 12 PK \ 026509046622



**EZ AIM® PAPER BULLSEYE TARGET 12IN X 12IN, 12 PACK**

• PAPER DIMENSIONS: 12IN X 12.25IN  
15496 \ 12 PK \ 026509048008



**EZ AIM® PAPER BULLSEYE 12IN X 12IN, 13 PACK**

• PAPER DIMENSIONS: 12IN X 12IN  
15334 \ 12 PK \ 026509048145



**EZ AIM® PAPER BULLSEYE 8IN X 8IN, 26 PACK**

• PAPER DIMENSIONS: 8.5IN X 8.5IN  
15246 \ 12 PK \ 026509046639

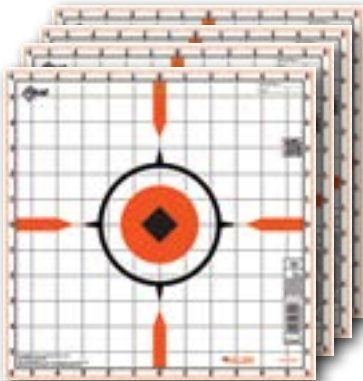

**NEW**

**EZ AIM® RIGID SIGHT-IN TARGET 12IN X 12IN, 10 PACK**

• PAPER DIMENSIONS: 12IN X 12IN  
15576 \ 12 PK \ 026509062547

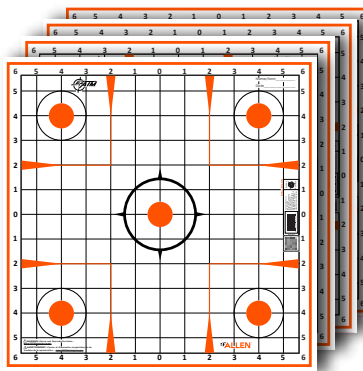

**EZ AIM® PAPER SIGHT-IN GRID 12IN X 12IN, 13 PACK**

• PAPER DIMENSIONS: 12IN X 12IN  
15333 \ 12 PK \ 026509048138

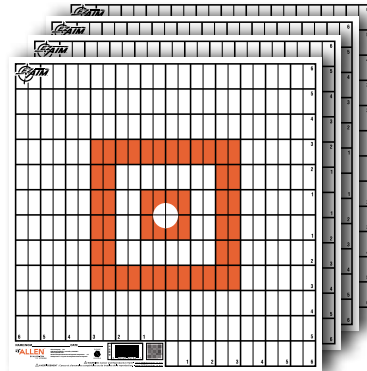

**EZ AIM® PAPER GRID TARGET 12IN X 12IN, 12 PACK**

• PAPER DIMENSIONS: 12IN X 12.25IN  
15495 \ 12 PK \ 026509047421



**EZ AIM® SILHOUETTE GREEN**  
**12IN X 18IN, 10 PACK**  
 • PAPER DIMENSIONS: 12IN X 18IN  
**15204 \ 12 PK \ 026509046554**

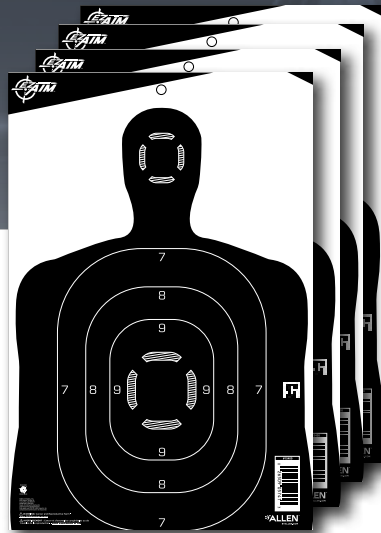

**EZ AIM® PAPER SILHOUETTE**  
**BLACK 12IN X 18IN, 100 PACK**  
 • PAPER DIMENSIONS: 12IN X 18IN  
**15400 \ 1 PK \ 026509057413**

**NEW**  
**EZ AIM® PAPER SILHOUETTE**  
**BLACK & WHITE,**  
**12IN X 18IN, 25 PACK**  
 • PAPER DIMENSIONS: 12IN X 18IN  
**15447 \ 12 PK \ 026509042778**

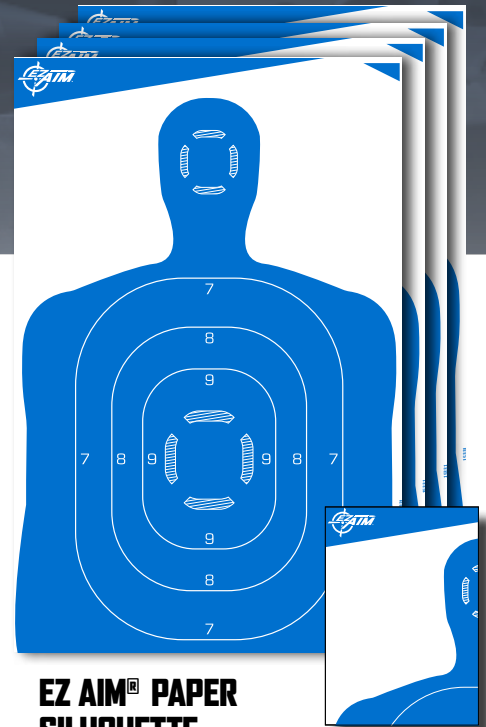

**EZ AIM® PAPER**  
**SILHOUETTE**  
**BLUE 23IN X 35IN**  
 • COMES FOLDED TO 11.5IN X 17.5IN  
 4 PACK  
**15331 \ 12 PK \ 026509048114**  
 100 PACK  
**15289 \ 1 PK \ 026509051367**

PACKAGED SIZE:  
 11.5IN X 17.5IN

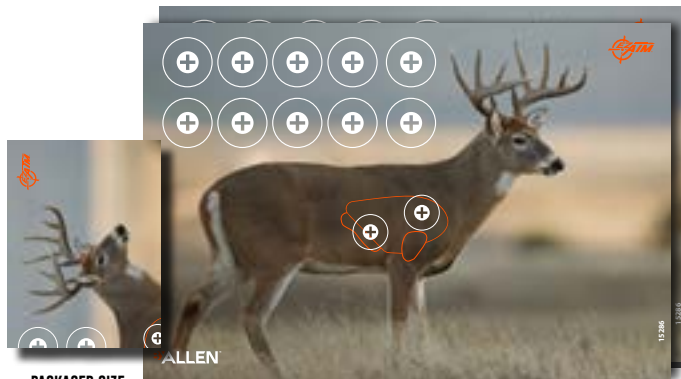

PACKAGED SIZE:  
 11.5IN X 17.5IN

**EZ AIM® PAPER FOUR COLOR**  
**WHITETAIL 23IN X 35IN, 2 PACK**  
 • COMES FOLDED TO 11.5IN X 17.5IN  
 • PAPER DIMENSIONS: 23IN X 35IN  
**15286 \ 12 PK \ 026509046844**

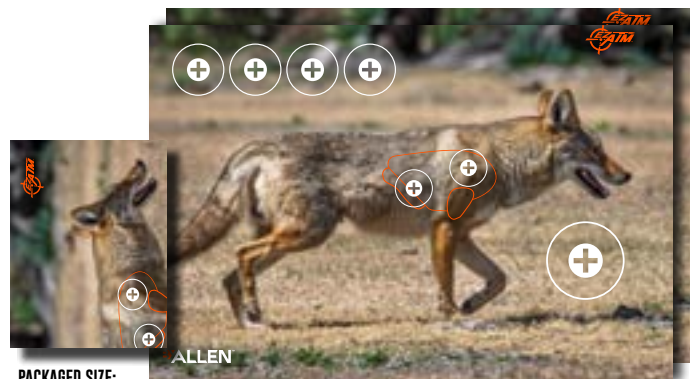

PACKAGED SIZE:  
 11.5IN X 17.5IN

**EZ AIM® PAPER FOUR COLOR**  
**COYOTE 23IN X 35IN, 2 PACK**  
 • COMES FOLDED TO 11.5IN X 17.5IN  
 • PAPER DIMENSIONS: 23IN X 35IN  
**15284 \ 12 PK \ 026509046837**

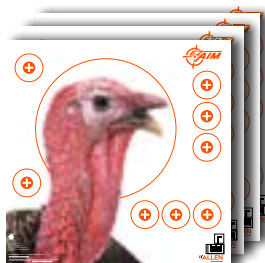

**EZ AIM® PAPER FOUR COLOR**  
**PATTERNING TURKEY**  
**12IN X 12IN, 6 PACK**  
 • PAPER DIMENSIONS: 12.5IN X 12.5IN  
**15322 \ 12 PK \ 026509048909**





# CUSTOM TARGET SYSTEMS:

NO OTHER TARGET MOUNTING SYSTEM IS AS VERSATILE AND SCALABLE AS THE EZ-AIM™ CUSTOM TARGET SYSTEM!



## EZ AIM® CUSTOM TARGET SYSTEMS MASTER TARGET SHOOTING KIT

- LEG KIT BREAKS DOWN TO CONVENIENT 16IN SECTIONS
- CHAIN KIT INCLUDES ALL HARDWARE FOR HANGING GONG TARGETS
- DURABLE, SELF HEALING POLYMER SPINNERS
- PAPER TARGET STAND HOLDS UP TO 2 PAPER TARGETS
- INCLUDES 3 BRACKETS FOR GALLERY EXPANSION

15476 \ 2 PK \ 026509043393

## EZ AIM® CUSTOM TARGET SYSTEMS QUICK-SET STEEL TARGET STAND

- QUICK AND EASY ASSEMBLY
- HIGH QUALITY STEEL
- ADAPTABLE TO THE EZ-AIM® CUSTOM TARGET SYSTEM

15348 \ 4 PK \ 026509048206



## EZ AIM® CUSTOM TARGET SYSTEMS DELUXE GONG HANGER KIT

- LEG KIT BREAKS DOWN TO 16IN SECTIONS
- CHAIN KIT INCLUDES ALL HARDWARE
- INCLUDES 2 BRACKETS FOR GALLERY EXPANSION

15478 \ 2 PK \ 026509045991

## PAPER TARGET STAND

- INCLUDES 8 CLIPS
- STEEL FRAME
- EASY ASSEMBLY

15295 \ 6 PK \ 026509038832

## EZ-RANGE PORTABLE TARGET STAND

- 16IN x 16IN TARGET BACKER BOARD INCLUDED
- 2 ADHESIVE TARGETS INCLUDED
- WORKS W/ EZ-AIM® CUSTOM TARGET SYSTEM

15309 \ 6 PK \ 026509051404



**NEW**  
EZ AIM® HORIZONTAL STEEL  
TARGET HANGING HOOK,  
2 PACK

- SOLID STEEL CONSTRUCTION
  - DESIGNED TO FIT 2x4 CROSSBAR
  - USE IN TANDEM TO HOLD GONGS W/ CHAINS
  - USE INDIVIDUALLY WITH CENTER HOLE TARGETS
- 15571 \ 6 PK \ 026509062462



**NEW**  
EZ AIM® GONG AND STEEL  
TARGET HANGING HOOK  
FOR 2x4 MOUNT

- STEEL CONSTRUCTION
  - USED WITH 2x4 LUMBER (NOT INCLUDED)
  - 3/8IN STEEL HOOK
  - HOLDS STEEL TARGETS WITH CENTER HOLE
- 15514 \ 4 PK \ 026509060680

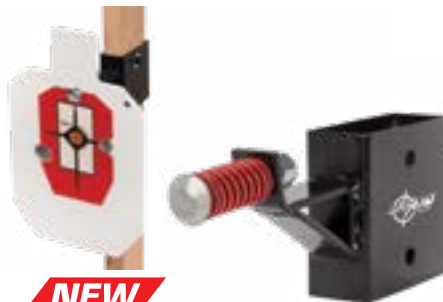

**NEW**  
EZ AIM® GONG HANGER  
W/ RECOIL SPRING  
FOR 2x4

- SOLID STEEL CONSTRUCTION
  - MOUNTS TO 2x4 LUMBER (NOT INCLUDED)
  - RECOIL REDUCING SPRING KIT INCLUDED
  - HOLDS STEEL TARGETS W/ A CENTER HOLE
  - HARDWARE INCLUDED
- 15515 \ 4 PK \ 026509060697



**NEW**  
EZ AIM® CUSTOM TARGET  
SYSTEMS RUBBER STRAP  
GONG HANGING KIT

- HANGS MOST GONGS WITH MOUNTING HOLES
  - ADAPTABLE TO EZ-AIM® CUSTOM TARGET SYSTEM
- 15247 \ 4 PK \ 026509046646



**NEW**  
EZ AIM® CUSTOM TARGET  
SYSTEMS 2x4 TARGET  
SYSTEM BRACKETS

- DURABLE STEEL CONSTRUCTION
  - MOUNTS ALL SHOOTING GALLERY ACCESSORIES TO A 2x4 STAND
- 15438 \ 6 PK \ 026509042433



**NEW**  
EZ AIM® CUSTOM TARGET  
SYSTEMS GONG CHAIN KIT

- 2 CHAINS PLUS HARDWARE
  - DESIGNED TO HANG MOST GONG TARGETS
  - WORKS FOR OTHER SIMILAR TARGETS
- 15587 \ 3 PK \ 026509064312



**NEW**  
EZ AIM® ADJUSTABLE  
TARGET STAND

- ALL STEEL CONSTRUCTION
  - DURABLE POWDER COATED FINISH
  - ADJUSTMENT KNOB ADJUSTS THE STAND
  - FITS TARGETS FROM 12IN - 17IN
  - USES 1x3 BOARDS (NOT INCLUDED)
- 15517 \ 1 PK \ 026509060710



**NEW**  
EZ AIM® TARGET STAND BASE  
FOR 2x4 UPRIGHT

- STEEL CONSTRUCTION
  - USED WITH 2x4 LUMBER (NOT INCLUDED)
  - CAN BE COMBINED W/ GONG HANGING HOOKS
  - DURABLE POWDER COAT FINISH
- 15543 \ 4 PK \ 026509061731



**NEW**

**EZ AIM® HARDROCK AR500  
3/8IN IPSC TARGET  
10IN X 6IN SILHOUETTE**

- AR500 ARMORPLATE STEEL, 3/8 INCH THICK
- DESIGNED FOR RIFLES AND HANDGUNS
- WHITE POWDERCOAT FINISH
- DESIGNED FOR CHAIN/STRAP HANGING
- FOR HOOK ATTACHMENT

**15585 \ 3 PK \ 026509064299**



**NEW**

**EZ AIM® HARDROCK AR500  
3/8IN IPSC TARGET  
20IN X 12IN SILHOUETTE**

- AR500 ARMORPLATE STEEL, 3/8 INCH THICK
- DESIGNED FOR RIFLES AND HANDGUNS
- DURABLE WHITE POWDERCOAT FINISH
- DESIGNED FOR CHAIN / STRAP HANGING
- DESIGNED FOR HOOK ATTACHMENT

**15586 \ 3 PK \ 026509064305**



**EZ AIM® HARDROCK AR500  
1/4IN IPSC TARGET  
14IN X 9IN SILHOUETTE**

- FOR RIMFIRE GUNS AND CENTERFIRE PISTOLS
- 9IN x 14<sup>15</sup>/<sub>16</sub>IN x 1/4IN THICKNESS
- IPSC 1/2 SIZE SILHOUETTE
- MOUNTING HOLES ON THE SHOULDERS
- ADAPTABLE TO THE EZ-AIM® CUSTOM TARGET SYSTEM

**15371 \ 3 PK \ 026509053866**

**NEW**

**EZ AIM® HARDROCK AR500 STEEL 1/2IN GONG TARGET**

- AR500 ARMORPLATE STEEL
- 1/2 INCH THICK
- DESIGNED FOR RIFLES AND HANDGUNS



**10IN GONG**

**15600 \ 3 PK \  
026509064411**



**8IN GONG**

**15598 \ 3 PK \  
026509064398**



**6IN GONG**

**15597 \ 3 PK \  
026509064381**



**4IN GONG**

**15596 \ 4 PK \  
026509064374**

**EZ AIM® HARDROCK AR500 STEEL 3/8IN GONG TARGETS**

- DURABLE AR500 STEEL
- 3/8IN THICKNESS
- UP TO 300WM AT 200 YARDS



**NEW 12IN GONG**

**15599 \ 3 PK \  
026509064404**



**10IN GONG**

**1538 \ 3 PK \  
026509043386**



**8IN GONG**

**15308 \ 3 PK \  
026509036258**



**4IN GONG**

**15304 \ 4 PK \  
026509036241**





**NEW**  
**EZ AIM® AR500 COYOTE**  
**3/8in THICK**

- WHITE POWDER COAT FINISH
  - EASY TO SEE BULLET IMPACTS
  - DESIGNED FOR HUNTING BULLETS AT 100 YARDS+
- 15574 \ 3 PK \ 026509062493

**NEW**  
**EZ AIM® AR500 PRAIRIE DOG**  
**3/8in THICK**

- WHITE POWDER COAT FINISH
  - EASY TO SEE BULLET IMPACTS
  - DESIGNED FOR HUNTING BULLETS AT 100 YARDS+
- 15572 \ 3 PK \ 026509062479

**NEW**  
**EZ AIM® AR500 BEAR**  
**3/8in THICK**

- WHITE POWDER COAT FINISH
  - EASY TO SEE BULLET IMPACTS
  - DESIGNED FOR HUNTING BULLETS AT 100 YARDS+
- 15573 \ 3 PK \ 026509062486



**EZ AIM® HARDROCK AR500**  
**STEEL SMALL CIRCLE SPINNER**  
**CENTERFIRE TARGET**

- TARGET SIZES: 3IN, 4IN
  - FOR RIMFIRE GUNS AND CENTERFIRE PISTOLS
  - 1/4IN THICKNESS
- 15344 \ 3 PK \ 026509048183



**EZ AIM® HARDROCK AR500**  
**STEEL MEDIUM CIRCLE SPINNER**  
**CENTERFIRE TARGET**

- TARGET SIZES: 4IN, 5IN
  - FOR RIMFIRE GUNS AND CENTERFIRE PISTOLS
  - 1/4IN THICKNESS
- 15366 \ 3 PK \ 026509053811

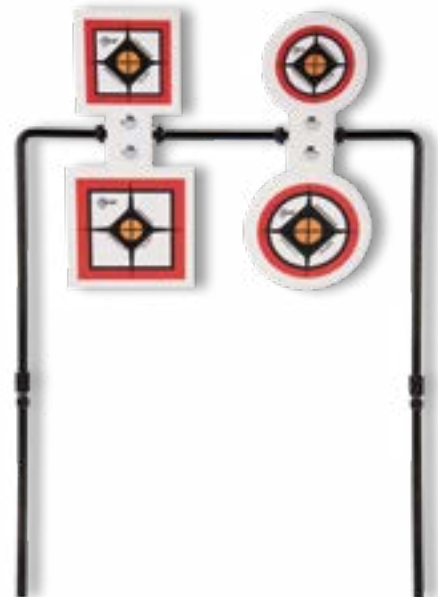

**NEW**  
**EZ AIM® AR500 DOUBLE**  
**HARDROCK STEEL**  
**SPINNER 4IN X 5IN**

- AR500 ARMORPLATE STEEL
  - WHITE POWDERCOAT FINISH
  - COMBINED 4 INCH TOP & 5 INCH BOTTOM TARGET
- 15593 \ 3 PK \ 026509064343



**EZ AIM® HARDROCK AR500**  
**STEEL MEDIUM SQUARE SPINNER**  
**CENTERFIRE TARGET**

- FOR RIMFIRE GUNS AND CENTERFIRE PISTOLS
  - 1/4IN THICKNESS
  - TARGET SIZES: 4IN, 5IN
- 15365 \ 3 PK \ 026509053804



**EZ AIM® HARDROCK AR500**  
**STEEL 7IN SQUARE PLATE**  
**CENTERFIRE TARGET**

- FOR CENTERFIRE RIFLES AND PISTOLS
  - 3/8IN THICKNESS
  - TARGET SIZE: 7IN
- 15367 \ 3 PK \ 026509053828



# HEAVY-DUTY STEEL CONSTRUCTION

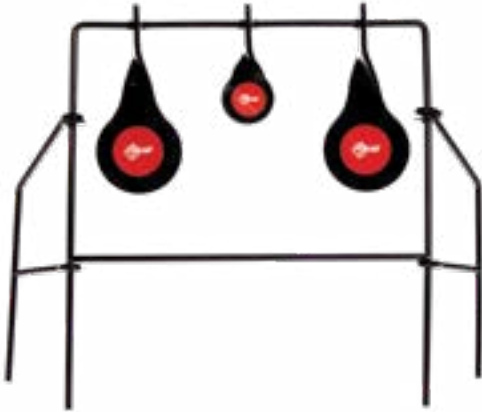

## METAL SPINNER TARGET

- 2 EACH 2.25IN SPINNER TARGETS
- 3/16IN THICK STEEL SPINNERS
- 1 EACH 1.5IN SPINNER TARGET
- SOLID STEEL CONSTRUCTION

15265 \ 6 PK \ 026509038887

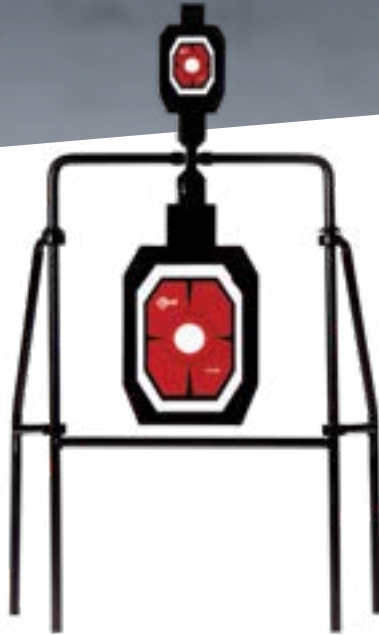

## STEEL SILHOUETTE SPINNER TARGET

- FOR RIMFIRE GUNS AND CENTERFIRE PISTOLS
- SILHOUETTE SHAPED SPINNER
- 1/4IN STEEL PLATE
- FOLDING EASEL TYPE STAND
- SOLID STEEL CONSTRUCTION

15243 \ 3 PK \ 026509035732



RUGER

## **NEW** RUGER® 10/22® STEEL SPINNER TARGET

- FOR RIMFIRE AND AIR RIFLES
- 3/16IN THICK STEEL SPINNER
- 2-1/2IN AND 1-3/4IN WIDE TARGETS
- FOLDING STAND
- ADAPTABLE TO ALLEN CUSTOM TARGET SYSTEMS

70577 \ 6 PK \ 026509060895

## FOR .22 RIFLES/ PISTOLS & AIR GUNS



## DEFLECTOR TRIPLE STEEL TARGET

- FOR .22 RIFLES, PISTOLS AND AIRGUNS
- 3/16IN THICK STEEL SPINNER
- SPINNER TARGET SIZES: 1.5IN, 2.25IN, 3.5IN
- HEAVY DUTY STEEL CONSTRUCTION

15403 \ 3 PK \ 026509057475

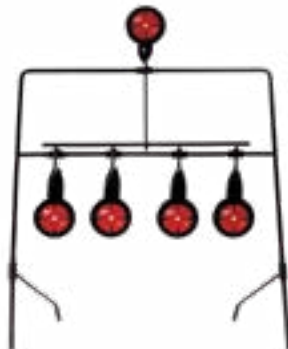

## DEFLECTOR RESETTING STEEL TARGET

- FOR RIMFIRE RIFLES AND AIRGUNS
- ONE RESETTING PLATE AND FOUR LOWER PLATES, 3/16IN THICK STEEL
- HEAVY DUTY STEEL CONSTRUCTION

15340 \ 4 PK \ 026509048152

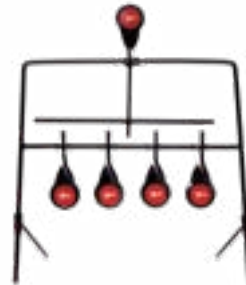

## METAL RESETTING STEEL TARGET

- FOR RIMFIRE OR AIR GUNS
- ONE RESETTING PLATE AND FOUR LOWER PLATES, 3/16IN THICK STEEL
- SOLID STEEL CONSTRUCTION

15285 \ 6 PK \ 026509038894



## AIR GUN PELLET TRAP

- 9IN X 7.15IN W/ 7.5IN DEPTH
- FOR AIR GUNS UP TO 1,000 FPS
- SPINNER TARGET SIZES: 1.5IN
- HIGH QUALITY STEEL

15429 \ 6 PK \ 026509009146

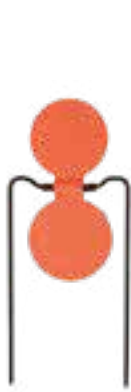

**EZ AIM® HOLEY  
SELF-HEALING  
SPINNER TARGET**

- SELF-HEALING TARGET
  - FOR GUNS UP TO .45 CALIBER
  - METAL FRAME
- 15460 \ 6 PK \ 026509038849**



**EZ AIM® PRAIRIE DOG  
SELF-HEALING  
SPINNER TARGET**

- SELF-HEALING TARGET
  - FOR RIMFIRE, HIGH POWER RIFLES,  
OR HANDGUNS
- 15468 \ 6 PK \ 026509042266**



**EZ AIM® POP CAN  
SELF-HEALING  
THROWABLE TARGET**

- SELF-HEALING TARGET
  - STRING FOR THROWING OR HANGING
  - FOR RIMFIRE, HIGH POWER RIFLES,  
OR HANDGUNS
- 15439 \ 6 PK \ 026509042181**



**EZ AIM® STAND-UP  
SELF-HEALING  
BOWLING PIN TARGET**

- SELF-HEALING TARGET
  - FOR GUNS UP TO .45 CALIBER
- 15462 \ 6 PK \ 026509038863**



CLAY NOT INCLUDED

**CLAY TARGET HOLDER**

- INCLUDES 2 CLAY TARGET HOLDERS
  - FITS STANDARD 4.5IN CLAY TARGETS
  - ADAPTABLE TO THE EZ-AIM® CUSTOM TARGET SYSTEM
- 15386 \ 6 PK \ 026509054801**



**HAND HELD TARGET THROWER**

- THROWS STANDARD SIZE CLAY TARGETS
  - FOR RIGHT OR LEFT HANDED THROWERS
  - EASY TO LOAD
  - LITTLE EFFORT NEEDED TO THROW TARGETS
- 22701 \ 6 PK \ 026509038825**



**CLAY TARGET  
THROWERS**



**1** PERSON OPERATION



THROWS SINGLES AND DOUBLES



FOOT TRIGGER STEP TO LAUNCH

**XCELERATOR CLAYMASTER  
TARGET THROWER**

- FOOT OPERATED TRIGGERING DEVICE
  - THROWS SINGLES AND DOUBLES
  - ADJUSTABLE THROWING ANGLE
  - ASSEMBLES IN UNDER 5 MINUTES
  - WIDE AND STABLE PLATFORM
- 2233 \ 1 PK \ 026509038900**

**CLAYMASTER  
TARGET THROWER**

- SOLID STEEL FRAME
  - STAKE MOUNT OR TIRE MOUNT OPTION
  - CUSHIONED PAD PREVENTS TARGET BREAKAGE IN THROWING ARM
  - THROWS SINGLES OR DOUBLES
  - ADJUSTABLE TENSION THROWING ARM SPRING
- 15236 \ 2 PK \ 026509035657**



**COMPETITOR  
PREMIUM RANGE BAG**

- 16.6IN X 9IN X 11.8IN MAIN COMPARTMENT
- INCLUDES INTERNAL TOTE FOR ORGANIZATION AND AMMO STORAGE
- FOLD-UP MAT INCLUDED FOR WORKING ON YOUR SHOTGUN OR PISTOLS
- LOCKABLE MAIN COMPARTMENT

8325 \ 2 PK \ 026509054238

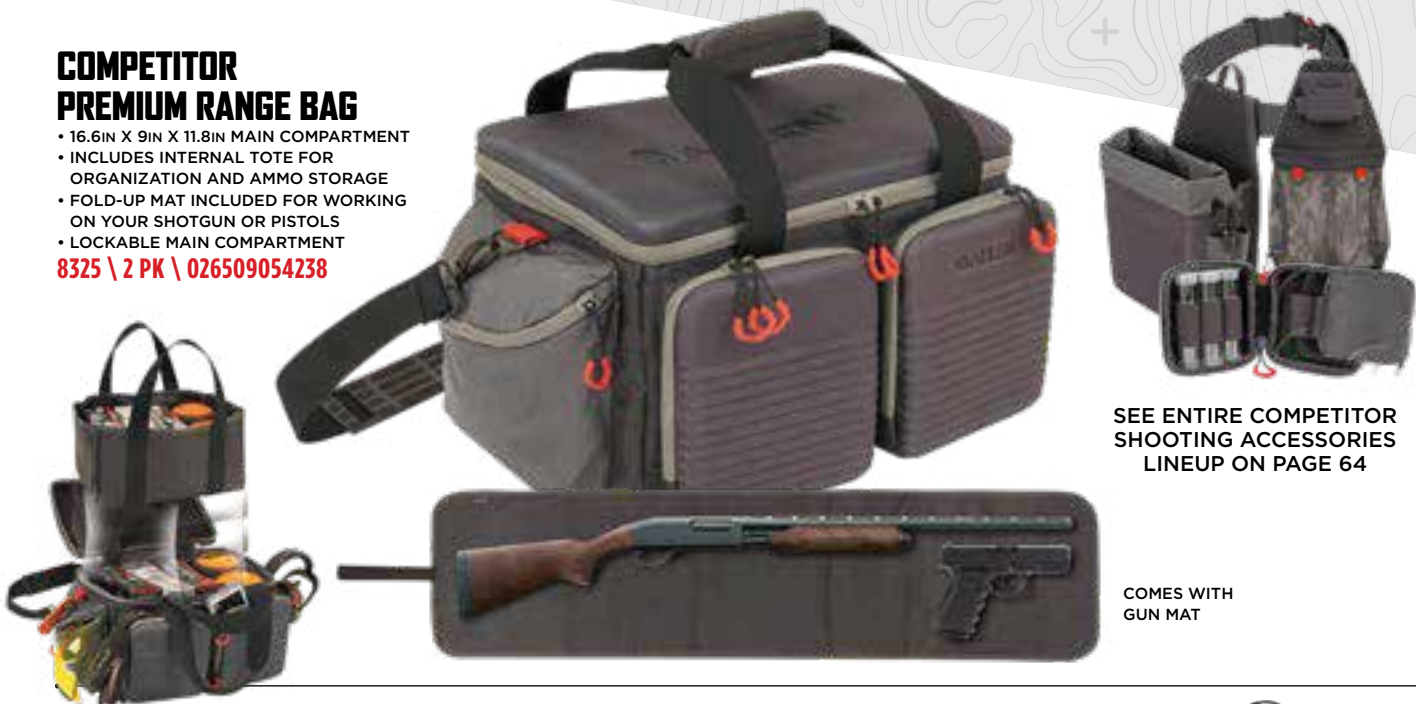

SEE ENTIRE COMPETITOR SHOOTING ACCESSORIES LINEUP ON PAGE 64

COMES WITH GUN MAT

**TRIUMPH RANGE BAG**

- 14.75IN X 10IN X 12IN MAIN COMPARTMENT
- EXTERNAL POCKETS WITH GENEROUS STORAGE
- FOLD-UP PISTOL MAT INCLUDED
- LOCKABLE MAIN COMPARTMENT

8329 \ 4 PK \ 026509054276



COMES WITH PISTOL MAT

SINCE  
**HERITAGE**  
1970

**NORTH PLATTE  
HERITAGE RANGE BAG**

- 14IN X 10IN X 9IN MAIN COMPARTMENT
- 100% COTTON CANVAS WITH DURABLE BACKING FOR SUPERIOR MOISTURE RESISTANCE AND DURABILITY
- DETACHABLE SHOULDER STRAP WITH METAL HARDWARE
- PADDED PISTOL RUG
- SPLIT LEATHER HANDLES AND TRIM
- HARD BOTTOM LINER
- 2 EXTERIOR POCKETS

8244 \ 4 PK \ 026509035237



COMES WITH PADDED PISTOL RUG



**GWG<sup>®</sup> MIDNIGHT RANGE BAG**

- 15IN X 8IN X 8IN MAIN COMPARTMENT
- EXTERNAL PADDED ZIP POCKETS WITH GENEROUS STORAGE
- MAGAZINE LOOPS IN FRONT POCKETS
- PISTOL RUG INCLUDED (SIZED TO FIT IN FRONT POCKET)
- ADJUSTABLE, REMOVABLE SHOULDER STRAP

**70639 \ 2 PK \ 026509051527**



**ELIMINATOR RANGEMASTER RANGE BAG**

- 15IN X 8.5IN X 8IN MAIN COMPARTMENT
- FOLD-UP PISTOL MAT INCLUDED
- RIGID BOTTOM WITH FEET

**8305 \ 4 PK \ 026509008866**



**DOLORES COMPACT RANGE BAG**

- 15IN X 10IN X 6.5IN MAIN COMPARTMENT
- DETACHABLE SHOULDER STRAP WITH PAD
- INTERNAL SOFT-LINED HANDGUN COMPARTMENT
- FOUR ELASTIC LOOPS FOR MAGAZINES
- CLEAR INTERNAL ORGANIZER POCKET

**18301 \ 3 PK \ 026509019770**



**RANGE BAG**

- 15IN X 8.5IN X 8IN MAIN COMPARTMENT
- DETACHABLE SHOULDER STRAP WITH METAL HARDWARE
- PADDED PISTOL RUG
- HARD BOTTOM LINER
- 12IN X 6IN X 1IN EXTERIOR POCKET
- THREE ROWS OF MOLLE LOOPS

**2205 \ 4 PK \ 026509022053**



**SPORTER RANGE BAG**

- 15IN X 8.5IN X 8IN MAIN COMPARTMENT
- DETACHABLE SHOULDER STRAP
- PADDED PISTOL RUG
- HARD BOTTOM LINER
- 12IN X 6IN X 1IN EXTERIOR POCKET

**8247 \ 4 PK \ 026509035268**



**REMOVABLE**  
INTERIOR  
ZIP POCKET

**COMPETITOR CHOKE TUBE CASE**

- HOLDS 6 CHOKE TUBES
- INCLUDES 3 EXTENDED CHOKE TUBE VIALS
- REMOVABLE INTERIOR ZIP POCKET
- DURABLE MOLDED EVA PANEL

8316 \ 4 PK \ 026509054184



**HEAVY-DUTY**  
METAL QUICK  
RELEASE BUCKLE

**INCLUDES**  
QUICK-DUMP  
REMOVABLE  
HULL BAG

**COMPETITOR ALL-IN-ONE  
SHOOTING BAG**

- HOLDS 50 SHOTGUN SHELLS
- HEAVY-DUTY METAL QUICK RELEASE BUCKLE
- INCLUDES QUICK-DUMP REMOVABLE HULL BAG
- DURABLE MOLDED EVA PANEL

8317 \ 4 PK \ 026509054191



**HEAVY-DUTY**  
METAL QUICK  
RELEASE BUCKLE

**INCLUDES**  
QUICK-DUMP  
REMOVABLE  
HULL BAG

**COMPETITOR DOUBLE  
COMPARTMENT SHELL BAG**

- HOLDS 50 SHOTGUN SHELLS
- HEAVY-DUTY METAL QUICK RELEASE BUCKLE
- INCLUDES QUICK-DUMP REMOVABLE HULL BAG
- DURABLE MOLDED EVA PANEL

8334 \ 4 PK \ 026509057437



**HEAVY-DUTY**  
METAL QUICK  
RELEASE BUCKLE

**COMPETITOR SINGLE  
COMPARTMENT SHELL BAG**

- HOLDS 50 SHOTGUN SHELLS
- HEAVY-DUTY METAL QUICK RELEASE BUCKLE
- DURABLE MOLDED EVA PANEL

8324 \ 4 PK \ 026509054221



**MAGNETIC  
CLOSURE**

**ATTACHES  
TO MOST BELTS**

**COMPETITOR OVER UNDER  
HULL BAG**

- HOLDS 125 SHOTGUN SHELLS
- SPRING CLIP OPENING WITH MAGNETIC CLOSURE
- DURABLE MOLDED EVA PANEL

8318 \ 4 PK \ 026509054207



**ATTACHES  
TO MOST BELTS**

**COMPETITOR SINGLE BOX  
SHELL CARRIER**

- HOLDS 25 SHOTGUN SHELLS
- DURABLE MOLDED EVA PANEL

8319 \ 4 PK \ 026509054214



**NEW**  
**COMPETITOR  
CHOKE TUBE CASE**

- DESIGNED TO HOLD 12 GAUGE CHOKE TUBES WITH NO RATTLE
- HOLDS 5 STANDARD CHOKE TUBES UP TO 3.25in
- HOLDS 3 EXTENDED TUBES UP TO 5in

8337 \ 4 PK \ 026509060505



**NEW**  
**COMPETITOR  
CHOKE TUBE WRENCH,  
CRANK STYLE, 12 GAUGE**

- EASY TO USE, ADJUST JUST ONCE
- CRANK HANDLE IS EASY ON FINGERS
- ADJUSTABLE TUBE DIAMETER
- 12 GAUGE ONLY

8336 \ 4 PK \ 026509060482



**NEW**  
**CHOKE TUBE VIALS, 3 PACK**

- LONG ENOUGH TO FIT MOST EXTENDED CHOKES
- DESIGNED FOR 12 GAUGE CHOKES AND SMALLER
- PROTECTS THREADS OF CHOKES FROM ELEMENTS

8338 \ 4 PK \ 026509063780



## SHELL & CHOKE CARRIERS



### TRIUMPH SINGLE BOX SHELL CARRIER

- HOLDS 25 SHOTGUN SHELLS
- ATTACHES TO MOST BELTS
- 2 D-RINGS FOR ATTACHING ITEMS

8327 \ 4 PK \ 026509054252



### TRIUMPH DOUBLE COMPARTMENT SHELL BAG

- HOLDS 50 SHOTGUN SHELLS
- 52IN WAIST BELT INCLUDED
- BOTTOM ZIP FOR FAST AND EASY SPENT HULL REMOVAL

8328 \ 4 PK \ 026509054269



### RIVAL DOUBLE COMPARTMENT SHELL BAG

- HOLDS 50 SHOTGUN SHELLS
- 52IN WAIST BELT INCLUDED
- BOTTOM ZIP FOR FAST AND EASY SPENT HULL REMOVAL

8332 \ 4 PK \ 026509054283



### RIVAL HULL BAG

- HOLDS 100 SHOTGUN SHELLS
- SPRING CLIP OPENING HOLDS BAG OPEN
- 52IN WAIST BELT INCLUDED

8333 \ 4 PK \ 026509054306



### ELIMINATOR CHOKE TUBE CASE

- BELT LOOP AND SNAP CLIP ATTACHMENT
- INCLUDES THREE CLEAR CHOKE TUBE VIALS
- SIX ELASTIC LOOPS TO HOLD CHOKE TUBES

8309 \ 4 PK \ 026509008941



### RIVAL CHOKE TUBE CASE

- HOLDS 3 CHOKE TUBES
- INCLUDES 3 EXTENDED CHOKE TUBE VIALS
- FRONT ZIPPER POCKET FOR ACCESSORIES
- ATTACHES TO MOST BELTS

8335 \ 4 PK \ 026509057499



### ELIMINATOR OVER/UNDER HULL BAG

- BELT CLIP ATTACHMENT
- SPRING CLIP OPENING IN MESH HULL BAG
- ZIP-OPEN BOTTOM

8307 \ 4 PK \ 026509008934



### ELIMINATOR BASIC DOUBLE COMPARTMENT SHOOTING BAG

- BELT INCLUDED
- MOLDED COMPONENTS ARE STRONG AND LIGHTWEIGHT

8303 \ 3 PK \ 026509008910



### ELIMINATOR PRO DOUBLE COMPARTMENT SHOOTING BAG

- BELT INCLUDED
- MOLDED COMPONENTS FOR STRENGTH AND LIGHTWEIGHT
- D-RING FOR TOWEL OR GLASSES CASE

8306 \ 4 PK \ 026509008927



### ELIMINATOR SINGLE BOX SHELL CARRIER

- BELT LOOP ATTACHMENT OPTIONS
- D-RINGS FOR ATTACHING TOWELS, SHOOTING GLASSES, ETC.

8310 \ 6 PK \ 026509008958



### SELECT CANVAS DOUBLE COMPARTMENT SHELL BAG

- TWO COMPARTMENTS
- HEAVY-DUTY WEB BELT

2306 \ 4 PK \ 026509008835



### SELECT CANVAS SINGLE BOX SHELL CARRIER

- HOLDS A BOX OF 25 SHOTGUN SHELLS
- UP TO 12 GAUGE 2 3/4 INCH SHELLS
- CONVENIENT BELT CLIP

2203 \ 6 PK \ 026509008828



**RAIL MOUNT BOZEMAN BIPOD**

- DESIGNED TO BE STRONG AND LIGHTWEIGHT
  - AT 11 OUNCES IT GIVES THE SHOOTER STABILITY WITH MINIMUM WEIGHT
  - ATTACHES TO ANY PICATINNY RAIL WITH A SINGLE SCREW
  - THE LEGS LOCK IN THE VERTICAL OR HORIZONTAL POSITION
  - ADJUSTABLE FROM 9IN TO 13IN
- 2192 \ 4 PK \ 026509021926**

**BOZEMAN BIPOD**

- THE SLING SWIVEL MOUNT VERSION OF THE BOZEMAN BIPOD IS DESIGNED TO ATTACH TO A RIFLE USING THE FRONT SLING SWIVEL STUD
- NO SPECIAL TOOLS ARE REQUIRED
- THERE IS AN ACCOMODATION FOR THE SLING SWIVEL MOUNT THAT ALLOWS THE USER TO ATTACH THE SLING DIRECTLY TO THE BIPOD
- LEGS FOLD FOR EASY CARRYING

**MEDIUM - ADJUSTABLE 9IN TO 13IN**  
**2188 \ 4 PK \ 026509021889**

**LOW - ADJUSTABLE 6IN TO 9IN**  
**2207 \ 4 PK \ 026509009092**

PICTURED:  
MEDIUM #2188

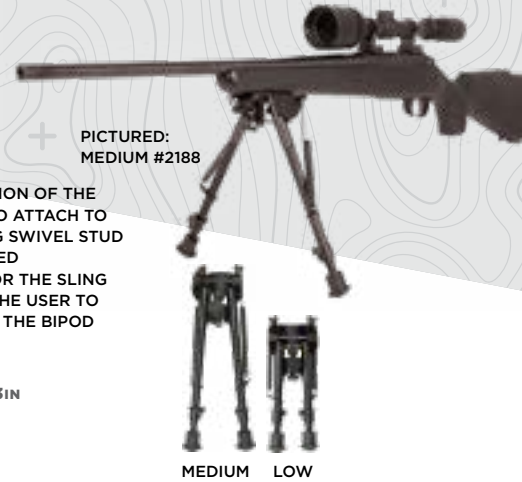

MEDIUM LOW



CALIFORNIA APPROVED

**CABLE LOCK**

- WORKS FOR SHOTGUNS, RIFLES AND HANDGUNS
- COMES WITH TWO KEYS

**9IN**  
**15413 \ 6 PK \ 026509008996**

**15IN**  
**15414 \ 6 PK \ 026509009009**



CALIFORNIA APPROVED

**TRIGGER GUN LOCK**

- WORKS FOR SHOTGUNS, RIFLES AND HANDGUNS
- COMES WITH TWO KEYS SINGLE-KEYED

**15415 \ 6 PK \ 026509009016**



**UNIVERSAL TRIGGER LOCK**

- FITS MOST HANDGUNS OR REVOLVERS
- UNIVERSAL KEY TOOL ATTACHMENT
- KEY TOOL WORKS FOR ALL ALLEN\* STANDARD GUN LOCKS
- NOT FOR USE WITH LEVER ACTION RIFLES

**18511 \ 24 PK \ 026509185116**



**RECOIL ERASER, RECOIL REDUCING PAD**

- REDUCES FELT RECOIL UP TO 70 PERCENT
- EASY TO INSTALL
- USES THE LATEST HIGH TECH RECOIL REDUCING POLYMER
- HIGH PERFORMANCE RECOIL REDUCTION AT A FRACTION OF THE COST OF OTHER PERFORMANCE BRANDS

**SMALL**  
**15511 \ 4 PK \ 026509155119**

**MEDIUM**  
**15512 \ 4 PK \ 026509155126**



Reversible



**SCOPE COVERS**

**SMALL**  
 FOR SCOPES AND NON-MAGNIFYING SCOPES UP TO 10IN LONG W/ 45MM LENS DIAMETER

**20171 \ 6 PK \ 026509201717**

**MEDIUM**  
 FOR SCOPES UP TO 12IN LONG W/ 44MM LENS DIAMETER

**20172 \ 6 PK \ 026509201724**

**LARGE**  
 FOR SCOPES UP TO 15IN LONG W/ 56MM LENS DIAMETER

**20173 \ 6 PK \ 026509201731**



**ACE SHOOTING VEST**

- FITS RIGHT OR LEFT HAND SHOOTERS
- MOVABLE SHOULDER PAD
- ADJUSTABLE SIDE STRAPS

**MED/LG**  
**22611 \ 3 PK \ 026509008804**

**XL/2XL**  
**22612 \ 3 PK \ 026509008811**



**NEW X-RING LASER BORESIGHTER**

- FITS: .50 CAL. RIFLES, HANDGUNS OR 12 GAUGE SHOTGUNS
- POSITIVE ON / OFF SWITCH
- EASY TO USE ADAPTERS
- MAKES SIGHT-IN EASY
- BATTERY INCLUDED

**70648 \ 4 PK \ 026509051718**



**UNIVERSAL SHOTGUN PLUG**

- WORKS FOR MOST SEMI-AUTO AND PUMP SHOTGUNS
- MANUFACTURED FROM RUGGED POLYMER

**1985 \ 6 PK \ 026509019855**



**RIFLE CARTRIDGE BELT**

- FITS WAISTS UP TO 52IN
- QUICK RELEASE BUCKLE
- HOLDS 20 RIFLE CARTRIDGES

212 \ 6 PK \ 026509002123



**SHOTGUN SHELL BELT**

- FITS WAISTS UP TO 52IN
- QUICK RELEASE BUCKLE
- HOLDS 25 SHOTGUN SHELLS

211 \ 6 PK \ 026509002116



**SHOTSHELL BANDOLIER**

- HOLDS UP TO 56 SHOTGUN SHELLS
- ONE SIZE FITS ALL (52IN)
- DESIGNED FOR 12 GAUGE SHOTSHELLS

220 \ 6 PK \ 026509002208



**ALPHA-LITE FOLDING GUN REST**

- FOLDS FLAT FOR EASY STORAGE
- SLIP RESISTANT BASE
- LIGHTWEIGHT

TALL, 8IN  
18407 \ 6 PK \ 026509020103



FOLDS FLAT



**FILLED WINDOW MOUNT GUN REST**

- NON-SLIP BOTTOM
- DESIGNED TO FIT OVER WINDOW OR FENCE RAIL
- INERT POLY BEAD FILL

18401 \ 4 PK \ 026509013433



**ELIMINATOR CONNECTED FILLED SHOOTING REST**

- NON-SLIP BOTTOM
- CONNECTED FILLED SHOOTING BAGS
- EASY TO CARRY
- INERT POLY BEAD FILL

1834 \ 3 PK \ 026509008965



**THERMOBLOCK™ FRONT AND REAR BAG SET**

- NOMEX HEAT-SHIELD SHOOTING PANEL
- RUBBER TREAD GRIPS SHOOTING BENCH
- CONSTRUCTED OF RUGGED FABRIC EXTERIOR
- SILICONE-TREATED RIFLE BUTTSTOCK AREA PROVIDES GRIP

18494 \ 3 PK \ 026509027508



**FILLED FRONT/REAR REST COMBO**

- NON-SLIP BOTTOM
- INERT POLY BEAD FILL

1830 \ 3 PK \ 026509013440



**FILLED BENCH BAG**

- NON-SLIP BOTTOM
- EASY TO CARRY SHOULDER STRAP
- INERT POLY BEAD FILL

1851 \ 3 PK \ 026509013426





**NEW**  
**X-FOCUS FILLED FRONT/  
 REAR SHOOTING REST  
 COMBO, COYOTE**

- CONNECTED WITH SIDE RELEASE BUCKLES
- TACKY TEXTURED GUN REST SURFACES
- TACKY GRIP MATERIAL ON BOTTOM
- INERT POLY BEAD FILL

**18411 \ 3 PK \ 026509064688**

**NEW**  
**X-FOCUS  
 FILLED BENCH BAG,  
 COYOTE**

- TACKY TEXTURED GUN REST SURFACES
- TACKY GRIP MATERIAL ON BOTTOM
- EASY CARRY SHOULDER STRAP
- INERT POLY BEAD FILL

**18412 \ 3 PK \ 026509064695**



**NEW**  
**X-FOCUS FOLDING REST  
 8.5in, COYOTE**

- LIGHTWEIGHT, PORTABLE SOLUTION
- FOLDS FLAT FOR EASY STORAGE AND RE-ASSEMBLES IN SECONDS TO FORM A SECURE REST
- SLIP-RESISTANT BASE

**18414 \ 4 PK \ 026509064718**

**NEW**  
**X-FOCUS FILLED WINDOW  
 MOUNT GUN REST,  
 COYOTE**

- DESIGNED TO FIT OVER A WINDOW, OR A FENCE RAIL
- TACKY TEXTURED GUN REST SURFACES
- TACKY GRIP MATERIAL ON BOTTOM
- INERT POLY BEAD FILL

**18413 \ 4 PK \ 026509064701**



**NEW**  
**ELIMINATOR CONNECTED  
 FILLED GUN REST, GRAY**

- CONNECTED WITH SIDE RELEASE BUCKLES
- EASY CARRY PARACORD HANDLE
- INTEGRATED CARTRIDGE CARRIER WITH 4 ELASTIC LOOPS
- FILLED WITH INERT POLY BEADS

18415 \ 3 PK \ 026509064725



**NEW**  
**ELIMINATOR FILLED FRONT/  
 REAR PREMIUM REST, GRAY**

- CONNECTED WITH SIDE RELEASE BUCKLES
- EASY CARRY PARACORD HANDLE
- INTEGRATED CARTRIDGE CARRIER WITH 4 ELASTIC LOOPS
- INERT POLY BEAD FILL

18417 \ 3 PK \ 026509064749



**NEW**  
**ELIMINATOR FILLED  
 BENCH BAG, GRAY**

- EASY CARRY PARACORD HANDLE
- INTEGRATED CARTRIDGE CARRIER WITH 4 ELASTIC LOOPS
- GUN CRADLE SILICONE DOT FABRIC
- INERT POLY BEAD FILL

18416 \ 2 PK \ 026509064732



**NEW**  
**ELIMINATOR  
 FILLED REST WITH LIGHTWEIGHT MATERIAL**

- IDEAL FOR BRINGING INTO THE FIELD
- DESIGNED TO FIT OVER A WINDOW OR A FENCE RAIL
- LIGHTWEIGHT INERT FOAM BEAD FILL

21923 \ 4 PK \ 026509053897



**NEW**  
**ELIMINATOR  
 LIGHTWEIGHT GUN REST BAG, ROUND**

- IDEAL FOR BRINGING INTO THE FIELD
- SILICONE RING TO ATTACH TO RIFLE/RIFLE SLING
- LIGHTWEIGHT INERT FOAM BEAD FILL

21924 \ 4 PK \ 026509053880



RECOIL ABSORBING  
REAR SUPPORT

OVERMOLDED  
SUPPORT HEAD

WEIGHT TRAY FOR  
PLATES OR BAGS

**SHOTTRAX RECOIL REDUCING SHOOTING REST**

- FINE METAL ELEVATION ADJUSTMENT SCREW WITH BALL BEARING MOVEMENT
- SOLID METAL CONSTRUCTION
- RECOIL ABSORBING REAR SUPPORT
- ADJUSTABLE LENGTH

21922 \ 2 PK \ 026509043843



RUBBER REAR  
SUPPORT

OVERMOLDED  
SUPPORT HEAD

**ACCUTRAK SHOOTING REST**

- SOLID 1.5IN DIAMETER METAL FRAME
- FINE ELEVATION ADJUSTMENT SCREW
- ELEVATION LOCKING SCREW
- OVERMOLDED SUPPORT HEAD
- RUBBER REAR SUPPORT

21920 \ 4 PK \ 026509043829

FINE ELEVATION  
ADJUSTMENT



**RANGEMASTER SHOOTING REST**

- VICE CLAMP SYSTEM
- ADJUSTABLE HEIGHT
- RUBBER COATED RESTS FOR THE FORE END AND BUTTSTOCK
- RUBBER FEET TO PREVENT SLIPPAGE

21951 \ 2 PK \ 026509045281







REAR GUN CRADLE

OVERMOLDED SUPPORT HEAD

**SHOTROCK RECOIL REDUCING SHOOTING REST**

- STEEL WEIGHT BEARING PLATE
- OVERMOLDED SUPPORT HEAD
- FINE ELEVATION ADJUSTMENT SCREW
- ELEVATION LOCKING SCREW

21925 \ 1 PK \ 026509053873



OVERMOLDED SUPPORT HEAD

**TRIAX FOREND SHOOTING REST**

- DURABLE POLYMER TRIPOD BASE
- FINE ELEVATION ADJUSTMENT SCREW
- ELEVATION LOCKING SCREW
- OVERMOLDED SUPPORT HEAD

21910 \ 6 PK \ 026509043805



PRECISION ADJUSTABLE

**CITADEL SHOOTING REST**

- NON-SLIP SILICONE TEXTURE GRIPS RIFLE FOREND
- HEAVY TRIAD BASE HELPS STABILIZE SHOOTER FOR MAXIMUM ACCURACY
- PRECISION ADJUSTMENT KNOBS MAKE SIGHT-IN EASY
- THERMOBLOCK™ NOMEX TECHNOLOGY WITHSTANDS 400+ DEGREE HEAT, ENSURING A LONGER LASTING REST

2999 \ 3 PK \ 026509026266

**SHOCKER™ TOM TAKER CLICK-STIX SHOOTING STICK 36IN**

- 36 INCH MAXIMUM HEIGHT
- ADJUSTABLE
- REMOVABLE RUBBER TIP
- COLLAPSIBLE
- V TOP HEAD

OLIVE  
21927 \ 4 PK \ 026509053927

**AXIAL EZ-STIK SHOOTING STICK MONOPOD 61IN**

- PUSH-BUTTON HEIGHT ADJUSTMENT
- ALUMINUM LOCKING CAMS
- PADDED STRAP
- CARBIDE TIP AND RUBBER BOOT
- POST ATTACHMENT SYSTEM

OLIVE  
21447 \ 4 PK \ 026509043690

**QUICK-SNAP**  
FAST & EASY  
CRADLE REMOVAL



**PADDED**  
HANDLE GRIP



**DURA-GRIP**  
RUBBER GRIP  
CRADLE

EASY AS 1,2,  
CLICK!

**1. GRIP**  
GRIP SECTION WITH  
WHITE ARROW

**2. PULL**  
PULL DOWN UNTIL  
POLES CONNECT

**3. CLICK!**  
CLICK-STIX CLICK  
WHEN LOCKED





### AXIAL CARBON ATOM SHOOTING STICK MONOPOD 61in

- LIGHTWEIGHT CARBON FIBER STICK
- GREAT FOR USE IN GROUND BLINDS AS A SHOOTING REST, CAMERA BASE OR WITH SPOTTING SCOPE
- HEIGHT ADJUSTS TO 61IN TALL
- REMOVABLE CRADLE WITH DURA-GRIP RUBBER GRIP
- ALUMINUM LOCKING CAMS
- CARBIDE TIP AND RUBBER BOOT

GREY  
21430 \ 4 PK \ 026509043706

### AXIAL CLICK-STIX MONOPOD 61in

- GREAT FOR USE IN GROUND BLINDS AS A SHOOTING REST, CAMERA BASE OR WITH SPOTTING SCOPE
- HEIGHT ADJUSTS TO 61IN TALL
- REMOVABLE CRADLE WITH DURA-GRIP RUBBER GRIP
- GREEN CAMO EVA HANDLE
- ALUMINUM TRIPOD AND LOCKING CAMS
- CARBIDE TIP AND RUBBER BOOT
- PADDED STRAP
- QUICK-SNAP POST ALLOWS FOR FAST CRADLE REMOVAL AND SEAMLESS SWITCHING BETWEEN ACCESSORIES

OLIVE  
21413 \ 4 PK \ 026509043669

**ULTRA-LITE**  
CARBON FIBER CONSTRUCTION

**DURA-GRIP**  
RUBBER GRIP CRADLE

61in  
EXTENDS UP TO 61in



**PACKABLE**  
EASY TO STORE  
AND TRANSPORT

**DURA-GRIP**  
RUBBER GRIP CRADLE

**QUICK-SNAP**  
FAST & EASY  
CRADLE REMOVAL





**QUICK-SNAP  
REMOVABLE  
CRADLE**



- ↑  
↓
- 61in**  
EXTENDS  
UP TO 61in
- ↙ ↘
- DURA-GRIP**  
RUBBER GRIP  
CIRCLE
- ⬇
- QUICK-SNAP**  
FAST & EASY  
CRADLE REMOVAL



**AXIAL SHOOTING STICK  
TRI/BI/MONOPOD 61in**

- CAN BE USED AS A TRIPOD, BIPOD OR MONOPOD
- GREAT FOR USE IN BLINDS FOR SHOOTING REST, CAMERA BASE OR SPOTTING SCOPE
- HEIGHT ADJUSTS TO 61in TALL
- REMOVABLE CRADLE WITH DURA-GRIP RUBBER GRIP
- CARBIDE TIPS AND RUBBER BOOTS
- QUICK-SNAP POST ALLOWS FOR FAST CRADLE REMOVAL AND SEAMLESS SWITCHING BETWEEN ACCESSORIES

**OLIVE**  
21412 \ 4 PK \ 026509043652

**AXIAL SHOOTING STICK  
BIPOD 61in**

- GREAT FOR USE IN BLINDS FOR SHOOTING REST, CAMERA BASE OR SPOTTING SCOPE
- HEIGHT ADJUSTS TO 61in TALL
- REMOVABLE CRADLE WITH DURA-GRIP RUBBER GRIP
- CARBIDE TIPS
- QUICK-SNAP POST ALLOWS FOR FAST CRADLE REMOVAL AND SEAMLESS SWITCHING BETWEEN ACCESSORIES

**OLIVE**  
21411 \ 4 PK \ 026509043645

**AXIAL SHOOTING STICK  
MONOPOD 61in**

- GREAT FOR USE IN BLINDS FOR SHOOTING REST, CAMERA BASE OR SPOTTING SCOPE
- HEIGHT ADJUSTS TO 61in TALL
- REMOVABLE CRADLE WITH DURA-GRIP RUBBER GRIP
- CARBIDE TIP AND RUBBER BOOT
- QUICK-SNAP POST ALLOWS FOR FAST CRADLE REMOVAL AND SEAMLESS SWITCHING BETWEEN ACCESSORIES

**OLIVE**  
21410 \ 4 PK \ 026509043638



ALLEN  
PATENTED  
PRODUCT



ALLEN  
PATENTED  
PRODUCT



TEXTURED  
MULTI-GRIP  
SURFACE

**SWIFT  
SHOOTING STICK, 61in**

- PADDED GRIP SURFACE
- BLACK MATTE FINISH ALUMINUM
- WORKS AS A CAMERA STAFF
- ADJUSTS FROM 21.5IN TO 61IN

2163 \ 6 PK \ 026509021636

**SWIFT  
SHOOTING STICK,  
34in**

- ALUMINUM SECTIONAL STAFF WITH CAM LOCKS
- PADDED FOAM GRIP
- MATTE BLACK FINISH
- ADJUSTS FROM 14.5IN TO 34IN

2164 \ 6 PK \ 026509021643



**VELOCITY CLICK-STIX SHOOTING STICKS**

- BREAK-DOWN PACKABLE FORMAT
- TEXTURED MULTI-GRIP SURFACE
- HIGH-STRENGTH ALUMINUM POLES
- ELASTIC CORD FOR STORAGE

**69in LENGTH**  
21402 \ 4 PK \ 026509043621

FOLDS DOWN  
FOR COMPACT  
STORAGE



**69in LENGTH** 

 **STANDING SHOTS**

 **STEADYING YOUR OPTICS**

**BUILT-IN**  
DIRECTIONAL MICROPHONES

**AUTO SHUT-OFF**  
HEARS & SEES  
PROTECTS EARS

**COMPACT**  
FOLDING DESIGN



COMPACT DESIGN FOR TRAVEL

**SHOTWAVE**

**SHOTWAVE™ LOW PROFILE EMUFF**

- MEETS ANSI S3.19 AND CE EN352-2
- BUILT-IN DIRECTIONAL MICROPHONES AMPLIFY RANGE COMMANDS AND OTHER AMBIENT SOUNDS TO A SAFE 82 dB
- AUTOMATICALLY SHUTS OFF AMPLIFICATION WHEN AMBIENT SOUND REACHES 82 dB
- OPERATED BY 2 AAA BATTERIES (NOT INCLUDED)

**2256 \ 4 PK \ 026509045236**



COMPACT DESIGN FOR TRAVEL

**SINGLE MICROPHONE EMUFF**

- MEETS ANSI S3.19 AND CE EN352-2
- SINGLE WIND RESISTANT, HIGH FREQUENCY MICROPHONES
- EXCELLENT SPEECH CLARITY
- POWERED BY 1 AAA BATTERY (NOT INCLUDED)

**2225 \ 4 PK \ 026509045274**



COMPACT DESIGN FOR TRAVEL



**GIRLS WITH GUNS® SHIELD LOW PROFILE ELECTRONIC MUFF**

- NRR 24 dB
- MEETS ANSI S3.19 AND CE EN352-2
- STEREO MICROPHONE
- AUX INPUT FOR MICROPHONE
- ADJUSTABLE, PADDED HEADBAND
- POWERED BY 2 AAA BATTERIES (NOT INCLUDED)

**2348 \ 4 PK \ 026509049784**



COMPACT DESIGN FOR TRAVEL



**GIRLS WITH GUNS® ASSURE LOW PROFILE MUFF**

- NRR 23 dB
- MEETS ANSI S3.19 AND CE EN352-2
- FOLDS DOWN FOR EASY TRANSPORTATION
- SOFT PADDED HEADBAND AND EAR CUPS

**2319 \ 3 PK \ 026509049722**





COMPACT  
DESIGN  
FOR TRAVEL



**SOUND DEFENDER  
PASSIVE SAFETY MUFF**

- MEETS ANSI S3.19 & CE EN352
- NRR 26 dB
- SOFT PADDED EAR CUPS
- OVERSIZED EAR CUPS
- PADDED HEADBAND

**2336 \ 3 PK \ 026509049708**

**RUGER**



**NEW**

**RUGER® 10/22® PASSIVE SAFETY MUFF**

- NRR 21
- LOW PROFILE CUP DESIGN
- ADJUSTABLE PADDED HEADBAND
- SOFT FOAM LINED EAR MUFFS

**70571 \ 3 PK \ 026509060833**

COMPACT  
DESIGN  
FOR TRAVEL



**REACTION LO-PROFILE  
SHOOTING MUFF**

- NRR 26 dB
- MEETS ANSI S3.19 AND CE EN352 REQUIREMENTS
- LOW PROFILE CUPS
- FOAM PADDED EAR CUP

**2287 \ 4 PK \ 026509022879**

COMPACT  
DESIGN  
FOR TRAVEL



**YOUTH SOUND SHIELD PASSIVE MUFF**

- MEETS ANSI S3.19 & CE EN352
- NRR 21 dB
- LOW PROFILE DESIGN
- SOFT FOAM LINED EAR CUPS
- ADJUSTABLE, PADDED HEADBAND

**2327 \ 3 PK \ 026509049685**

COMPACT  
DESIGN  
FOR TRAVEL



**STANDARD PASSIVE MUFF**

- MEETS ANSI S3.19 & CE EN352
- NRR 23 dB
- COMFORTABLE PADDED EAR CUPS
- FLEXIBLE AND ADJUSTABLE HEADBAND

**2274 \ 3 PK \ 026509045267**



**STANDARD HEARING PROTECTION**

- NRR 23 dB
- FLEXIBLE AND ADJUSTABLE HEAD STRAP
- FOAM CUSHIONED
- EAR PADS

**2284 \ 6 PK \ 026509022848**



**NEW**

**RUGER® 10/22® FOAM PLUG & SHOOTING GLASSES COMBO**

- HIGH IMPACT POLYCARBONATE LENS
- SCRATCH RESISTANT LENS
- GLASSES: ANSI Z87.1+ RATED
- NRR PROTECTION OF 32DB

70579 \ 4 PK \ 026509064862



**GIRLS WITH GUNS® ASSURE EYE & EAR COMBO**

- MUFFS:
- NRR 23 dB
  - MEETS ANSI S3.19 AND CE EN352-2
  - FOLDS DOWN FOR EASY TRANSPORTATION
  - SOFT PADDED HEADBAND AND EAR CUPS

- GLASSES:
- ANSI Z87-1+
  - ANTI-SCRATCH COATING
  - PADDED TEMPLES

2388 \ 4 PK \ 026509051831



**NEW**

**RUGER® 10/22® PASSIVE MUFF & SHOOTING GLASSES COMBO**

- MEETS ANSI S3.19 & CE EN352
- HIGH IMPACT POLYCARBONATE LENS
  - SCRATCH RESISTANT COATING
  - GLASSES: ANSI Z87.1+ RATED
  - NRR PROTECTION OF 32DB

70573 \ 3 PK \ 026509060840

**REACTION LO-PROFILE SHOOTING MUFF AND GLASSES COMBO**

- MUFFS:
- NRR 26 dB
  - MEETS ANSI S3.19 AND CE EN352-2 REQUIREMENTS
  - LOW PROFILE CUPS
  - FOLDS DOWN FOR EASY TRANSPORTATION

- GLASSES:
- ANSI Z87+ HIGH VELOCITY IMPACT RESISTANCE
  - ANTI-SCRATCH
  - NON-SLIP RUBBER NOSE PIECE

2316 \ 4 PK \ 026509023166

**PASSIVE MUFF & EYE PROTECTION COMBO**

MEETS ANSI S3.19 & CE EN352

- MUFFS:
- NRR 23 dB
  - FOLD DOWN FOR EASY TRANSPORTATION
  - FLEXIBLE PADDED EAR CUPS
  - ADJUSTABLE SIZING

- GLASSES:
- ANSI Z87.1+ IMPACT RESISTANCE
  - SOFT RUBBER NOSE PIECE
  - LIGHTWEIGHT

2229 \ 3 PK \ 026509045298

**GAMMA JUNIOR MUFF AND GLASSES COMBO**

- MUFFS:
- NRR 23 dB
  - MEETS ANSI S3.19 AND CE EN352-2 REQUIREMENTS
  - FOLDS DOWN FOR EASY TRANSPORTATION
  - SOFT PADDED HEADBAND AND EAR CUPS
  - ADJUSTABLE SIZING

- GLASSES:
- ANSI Z87+ IMPACT RESISTANCE
  - ANTI-SCRATCH COATING
  - SOFT TEMPLE PADS FOR COMFORT

2325 \ 4 PK \ 026509018995



**BANDED EAR PLUGS**

- NRR 22 dB
- FOLDING DESIGN FITS INTO SHIRT POCKET
- CAN BE WORN OVER THE HEAD OR BEHIND THE NECK

2296 \ 6 PK \ 026509022961



**SHOTWAVE™ EAR BUD**



- NOISE REDUCTION RATING FROM 12-25 dB
- PUSH BUTTON TO HEAR, PUSH AGAIN TO PROTECT YOUR HEARING

2398 \ 6 PK \ 026509026556



**MOLDED EAR PLUG WITH CORD**

- NRR 24 dB
- CE EN352-2
- SUPPLE POLYMER MATERIAL
- COMFORTABLE FOR EXTENDED USE

2293 \ 12 PK \ 026509022930



**GIRLS WITH GUNS® SILENCER FOAM EAR PLUGS**

- NRR 32 dB
- ANSI S3.19
- CE EN352-2
- COMFORTABLE AND EASY TO USE

6 PAIRS  
2389 \ 6 PK \ 026509051848



**SILENCER FOAM EAR PLUGS**

- NRR 32 dB
- ANSI S3.19
- CE EN352-2
- COMFORTABLE AND EASY TO USE
- HI-VIS ORANGE

6 PAIRS  
2343 \ 6 PK \ 026509010517

50 PAIRS  
2354 \ 5 PK \ 026509049845



**NEW**  
**RUGER® 10/22® FOAM EAR PLUGS**

- NRR 32 dB HEARING PROTECTION
- ANSI S3.19 AND CE EN352-2 RATED
- MOLDABLE FOR A CUSTOM FIT EVERY TIME

6 PAIRS  
70563 \ 6 PK \ 026509060826





CE

**TRIGGER METAL FRAME SHOOTING GLASSES**

- GREAT FOR SHOOTING AND SAFETY
- ANTI-FOG COATING
- UV COATED
- ANTI-SCRATCH COATING
- ANSIZ87+ RATED

2368 \ 3 PK \ 02650904989



CE

**GIRLS WITH GUNS® AFIRE SHOOTING GLASSES**

- GREAT FOR SHOOTING AND SAFETY
- ANTI-FOG COATING
- UV COATED
- ANTI-SCRATCH COATING
- ANSIZ87+ RATED

2370 \ 3 PK \ 026509049913



CE

**GIRLS WITH GUNS® DEVOTEE SHOOTING GLASSES**

- GREAT FOR SHOOTING AND SAFETY
- ANTI-FOG COATING
- UV COATED
- PADDED NOSE AND TEMPLES
- HIGH IMPACT POLYCARBONATE LENS
- ANTI-SCRATCH COATING
- ANSIZ87+ CE RATED

2371 \ 4 PK \ 026509049920



CE

**ASPECT SHOOTING GLASSES**

- GREAT FOR SHOOTING AND SAFETY
- ANTI-FOG COATING
- PADDED NOSE AND TEMPLES
- HIGH IMPACT POLYCARBONATE LENS
- SCRATCH RESISTANT COATING
- ANSIZ87+ CE RATED

2380 \ 4 PK \ 026509050018



CE

**OUTLOOK SHOOTING GLASSES**

- GREAT FOR SHOOTING AND SAFETY
- ANTI-FOG COATING
- PADDED NOSE AND TEMPLES
- HIGH IMPACT POLYCARBONATE LENS
- SCRATCH RESISTANT COATING
- ANSIZ87+ CE RATED

CLEAR  
2383 \ 4 PK \ 026509050049

YELLOW  
2382 \ 4 PK \ 026509050032



CE

**KEEN SHOOTING GLASSES**

- GREAT FOR SHOOTING AND SAFETY
- ANTI-FOG COATING
- PADDED NOSE AND TEMPLES
- HIGH IMPACT POLYCARBONATE LENS
- SCRATCH RESISTANT COATING
- ANSIZ87+ CE RATED

CLEAR  
2378 \ 4 PK \ 026509049999

YELLOW  
2377 \ 4 PK \ 026509049982

\* SHIPS BULK,  
INDIVIDUALLY  
POLY BAGGED



**GUARDIAN SHOOTING GLASSES**

- GREAT FOR SHOOTING AND SAFETY
- ANTI-FOG COATING
- PADDED NOSE AND TEMPLES
- HIGH IMPACT POLYCARBONATE LENS
- SCRATCH RESISTANT COATING
- ANSIZ87+ CE RATED

CLEAR  
2384 \ 12 PK \ 026509050056

YELLOW  
2379 \ 12 PK \ 026509050001



**FIT OVER SHOOTING GLASSES**

- ANSI Z87 IMPACT RESISTANCE
- LARGE SIZE FOR USE OVER PRESCRIPTION GLASSES
- SMOKE LENS FOR SUNNY DAY PROTECTION
- ANTI-SCRATCH COATING
- CE CERTIFIED

CLEAR  
2169 \ 4 PK \ 026509021698

YELLOW  
2170 \ 4 PK \ 026509021704



**NEW**

**DEMOLITION FITOVER SHOOTING GLASSES**

- ANTI FOG COATINGS REDUCE CONDENSATION FROM BODY HEAT
- FITS OVER MOST SMALL TO LARGE FRAMED EYE GLASSES
- CONFORMS TIGHTER TO FACE CURVATURE FOR MAXIMUM BLAST PROTECTION
- ANTI SCRATCH COATED LENSES
- CE CERTIFIED
- ANSI Z87 IMPACT RATED

CLEAR  
70718 \ 12 PK \ 026509061489



**ALL-IN YOUTH SHOOTING GLASSES**

- GREAT FOR SHOOTING AND SAFETY
- ANTI-FOG COATING
- PADDED NOSE AND TEMPLES
- HIGH IMPACT POLYCARBONATE LENS
- SCRATCH RESISTANT COATING
- ANSIZ87+ CE RATED

2376 \ 4 PK \ 026509049975



**ION SHOOTING GLASSES  
3 LENS SET: CLEAR/YELLOW/SMOKE**

- INTERCHANGEABLE LENS SHOOTING GLASSES
- PADDED NOSE AND TEMPLE
- INCLUDES ZIPPER CASE FOR STORAGE/CARRY
- ANSI Z87.1 RATED
- CE ISO12312-1:2103

CLEAR/SMOKE/YELLOW  
2228 \ 4 PK \ 026509045304



**FACTOR SHOOTING GLASSES**

- ANSI Z87+ HIGH VELOCITY
- CE ISO12312-1:2103
- ANTI-FOG
- ANTI-SCRATCH
- LIGHTWEIGHT FRAMELESS CONSTRUCTION
- DUAL INJECTION RUBBER TEMPLES
- WRAP AROUND FRAME
- WIDE FIELD OF VISION

CLEAR  
22753 \ 4 PK \ 026509227533



**REACTION SHOOTING GLASSES**

- ANSI Z87+ HIGH VELOCITY IMPACT RESISTANCE
- ANTI-SCRATCH
- WRAP AROUND FRAME
- WIDE FIELD OF VISION
- NON-SLIP RUBBER NOSE PIECE
- LENGTH ADJUSTABLE TEMPLE

DARK GRAY/YELLOW  
2272 \ 4 PK \ 026509022725



\* SHIPS BULK,  
INDIVIDUALLY  
POLY BAGGED

**PROTECTOR SHOOTING GLASSES**

- ANSIZ87+ CE RATED
- GREAT FOR SHOOTING AND SAFETY
- ANTI-FOG COATING
- PADDED NOSE AND TEMPLES
- HIGH IMPACT POLYCARBONATE LENS
- SCRATCH RESISTANT COATING
- WRAP AROUND FRAME
- WIDE FIELD OF VISION

CLEAR  
2385 \ 12 PK \ 026509050063



**KROME™ GUN CENTER TOOL BOX CLEANING KIT: 66 PIECES**

- TWO 3-PIECE CLEANING RODS (.22 - .300) AND (SHOTGUN)
- FOUR BRASS SLOTTED TIPS (.22, .270, .30, SHOTGUN)
- POLYMER MUZZLE GUARDS FOR EACH OF THE CLEANING RODS
- BRONZE BORE BRUSHES, COTTON SWAB BRUSHES, AND BRASS JAGS FROM .22 CALIBER TO 12 GAUGE
- BRASS ADAPTER FOR TOOLS WITH 6-32 THREADS
- PICK AND BRUSH SET
- CLEANING SWABS
- 1IN, 1.5IN, 2IN AND 3IN CLEANING PATCHES
- TWO REMOVABLE STORAGE TRAYS

**70548 \ 1 PK \ 026509045311**

BUILT IN SEPARATORS FOR HOLDING YOUR SOLVENTS & CLEANING COMPONENTS

SLIDING DOOR AND COMPARTMENT WITH DIVIDERS HOLD YOUR CLEANING PATCHES IN PLACE

INCLUDES TWO TRAYS AND ALL COMPONENTS SHOWN BELOW:

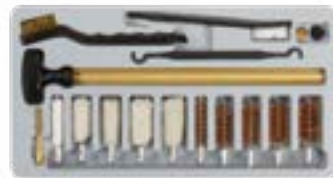

SHOTGUN CLEANING COMPONENTS



RIFLE/HANDGUN CLEANING COMPONENTS

ADDITIONAL DRAWER FOR STORAGE





# ESSENTIAL GUN CLEANING SYSTEM

## KROME™ LARGE UNIVERSAL CLEANING KIT, RIFLE/HANDGUN/SHOTGUN: 50 PIECES

- 3 PIECE BRASS ROD .22-.270 (FULLY ASSEMBLED TO 32 INCHES LONG)
- 3 PIECE BRASS ROD 7MM, HANDGUN, SHOTGUN (FULLY ASSEMBLED TO 32 INCHES LONG)
- 2 CLEANING ROD HANDLES
- 2 MUZZLE GUARDS (FOR BOTH SIZES OF CLEANING RODS ABOVE)
- BRASS ADAPTER FOR SHOTGUN BRUSHES AND SWABS
- BRASS ADAPTER FOR 6-32 THREADS
- BRASS CLEANING JAG: .22, .243, .25, 6.5MM (.260), .270, 7MM (.284), .30, .35
- BRONZE BORE BRUSHES: .22, .243, .25, 6.5MM (.260), .270, 7MM (.284), .30, .35, 9MM (.357-.38), .40, .45
- RIFLE AND HANDGUN SWABS: .22, .270, .30
- BRONZE SHOTGUN BRUSHES: 12 AND 20 GAUGE
- SHOTGUN SWABS: 12 AND 20 GAUGE
- BRASS SLOTTED TIPS: SHOTGUN, .30 CALIBER AND UP, .22 TO 7MM.
- BRONZE BRUSH, NYLON BRUSH AND DOUBLE ENDED PICK.
- SUPPLY OF 1 INCH, 1.5 INCH, 2 INCH AND 3 INCH PATCHES
- 10 TREATED GUN WIPES
- REMOVABLE STORAGE TRAY

70977 \ 3 PK \ 026509034971



**KROME™ STRONGHOLD UNIVERSAL CLEANING KIT,  
60 PIECE RIFLE / SHOTGUN / HANDGUN**

- 60 PIECE CLEANING KIT
- RUGGED MOLDED CASE
- RIFLE TO SHOTGUN TIP ADAPTER
- THREE PIECE, 5.2MM AND 6. MM CLEANING RODS
- 11 NYLON CLEANING JAGS: 6.5MM, 7MM, .22, .243, .25, .270, .30, .338, .38, .40, .45
- SLOTTED TIPS; .22, .30, .38, SHOTGUN
- SWABS: .410, 20 & 12 GA, .22, .243, .270, .30, 6.5MM, 7MM, .38, .40, .44
- BORE BRUSHES: 410, 20 & 12 GA, .22, .243, .270, .30, .338 6.5MM, 7MM, .38, .40, .44, .45, .50
- MUZZLE GUARDS, CLEANING PATCHES AND GUN WIPES

**70604 \ 4 PK \ 026509050964**



**KROME™ MODERN SPORTING RIFLE  
CLEANING KIT .22 & .223 CALIBER**

- 17 PIECE SET
- MOLDED CARRYING CASE
- RIFLE TO SHOTGUN TIP ADAPTER
- BOLT CARRIER BRUSH - .22 AND .308
- 11 NYLON CLEANING JAGS: 6.5MM, 7MM, .22, .243, .25, .270, .30, .338, .38, .40, .45
- BRASS SLOTTED TIP
- BRONZE BORE BRUSH - .22 AND .308
- 3 PIECE CLEANING ROD WITH ERGONOMIC HANDLE
- GAS TUBE BRUSH
- CLEANING ROPE
- BRASS CLEANING JAGS - .22 AND .308

**70605 \ 3 PK \ 026509050971**



**KROME™ COMPACT HANDGUN  
CLEANING KIT,  
14 PIECES**

- 14 PIECE CLEANING KIT
- BRASS CLEANING ROD
- SLOTTED TIPS FOR .22 AND CENTERFIRE ROUNDS
- MOLDED STORAGE BOX

**70607 \ 4 PK \ 026509050995**



**KROME™ UNIVERSAL CLEANING KIT,  
37 PIECES**

- BRASS RODS FOR BOTH RIFLE AND SHOTGUN
- COTTON SWABS: FOR .270, .30 CAL, .38-.357, .410 BORE, 12 GAUGE AND 20 GAUGE
- BRUSHES: .17, .22, .270, .30 CAL, 38-.357, .40, .45, .410 SHOTGUN, 12 AND 20 GAUGE
- SLOTTED TIPS: .22, .30 CAL, .357, AND SHOTGUN
- .17 CALIBER AND SHOTGUN ADAPTERS AND PATCHES

**70562 \ 4 PK \ 026509705628**



**ULTIMATE GUN CLEANING KIT:  
65 PIECES**

- BRONZE BRUSHES: 3 SHOTGUN, 9 RIFLE/PISTOL, 2 MUZZLE LOADER
- COTTON SWABS: 3 SHOTGUN
- COTTON SWABS: 3 RIFLE/PISTOL
- PLASTIC SLOTTED TIPS FOR SHOTGUNS: 2 BRASS, 2 ADAPTERS FOR SHOTGUN, RIFLE AND SMALL BORE RIFLE
- BRASS JAGS: 13
- BRASS RAMRODS: RIFLE & SHOTGUN
- MUZZLE GUARDS FOR EACH RAMROD
- 3 PIECE BRUSH AND PICK SET
- COTTON CLEANING PATCHES
- 10 COTTON SWABS
- 10 CLEANING CLOTHS

**70540 \ 1 PK \ 026509705406**

**ULTIMATE TACTICAL GUN CLEANING KIT:  
66 PIECES**

- BRONZE BORE BRUSHES: 2 SHOTGUN, 9 RIFLE/PISTOL
- COTTON SWABS: 2 SHOTGUN, 3 PISTOL
- BRASS JAGS: 8 RIFLE/PISTOL
- BRASS SLOTTED TIPS: SHOTGUNS, RIFLE/PISTOL .22 & .30 CAL.
- BRASS ADAPTERS: 3
- SPECIALTY TOOLS FOR MSR
- UPPER RECEIVER BRUSH
- BOLT CAM PIN BRUSH
- CHAMBER BRUSH .223 & .308
- TUBE CLEANING BRUSH
- HEX HANDLE FOR USE WITH ONE PIECE OF BRASS ROD
- CLEAR PLASTIC TUBE & ROPE
- TWO RAMRODS: SHOTGUN & RIFLE/HANDGUN
- MUZZLE GUARDS FOR EACH RAMROD: 4MM AND 6MM
- THREE PIECE BRUSH & PICK SET
- 10 COTTON CLEANING PATCHES
- 10 COTTON SWABS
- 10 CLEANING CLOTHS

**70541 \ 1 PK \ 026509705413**



**GUN CLEANING TOOL SET**

- MAKES CLEANING EASIER
- SLOT AND CREVICE PICK
- SMALL NYLON BRUSH
- BRASS BRISTLE BRUSH

**706 \ 6 PK \ 026509007067**

**GUN CLEANING KIT FOR 12 AND 20 GAUGE  
SHOTGUNS .22 TO .30 CALIBER RIFLES  
.22, .357, .38 CALIBER AND 9MM PISTOL**

- SHOTGUN ADAPTER BRUSHES FOR 12 AND 20 GAUGE
- SWABS FOR 12 AND 20 GAUGE
- SLOTTED TIP FOR SHOTGUNS
- BRASS SLOTTED TIP FOR .30 TO .38 CALIBER
- BRASS SLOTTED TIP FOR .22 CALIBER
- SWABS: .270/7MM, .30 CALIBER, .38/.357/9MM
- BRUSHES: .22 CALIBER, .30 CALIBER, .38/.357/9MM
- CLEANING PATCHES

**70599 \ 6 PK \ 026509705994**



**SILICONE CLEANING CLOTH**

- 10IN X 9.5IN SIZE
- A MUST FOR GUN CARE AS WELL AS WIPING DOWN ANY METAL ITEM

**70569 \ 12 PK \ 026509705697**



**GUN WIPES, 3 PER PACK**

- 13.5IN X 8IN SIZE
- SILICONE TREATED DISPOSABLE WIPES
- REMOVES MOISTURE, FINGERPRINTS AND DEBRIS

**70628 \ 6 PK \ 026509051152**



**GUN WIPES, 12 PER PACK**

- 13.5IN X 8IN SIZE
- SILICONE TREATED DISPOSABLE WIPES
- REMOVES MOISTURE, FINGERPRINTS AND DEBRIS

**70629 \ 6 PK \ 026509051169**





by **ALLEN**  
**BORE-NADO**<sup>TM</sup>  
**BARREL CLEANING ROPE**

THE BORE-NADO<sup>TM</sup> SYSTEM CLEANS THE INSIDE OF YOUR BARREL IN A SINGLE STROKE WITH A BUILT-IN BRUSH AND SWAB. THE BUILT-IN BRUSH REMOVES FOULING AND THE BRAIDED SWAB SWEEPS IT AWAY.

**BORE-NADO<sup>TM</sup> CLEANING SYSTEM**

• COMES IN MULTIPLE SIZES TO FIT RIFLES, SHOTGUNS, AND HANDGUNS. SINGLE STROKE BRUSH AND SWAB.

**HANDGUN:**



.22 CALIBER  
70580 \ 6 PK \ 026509019152

9MM/.357 CALIBER  
70582 \ 6 PK \ 026509019213

.40 CALIBER  
70583 \ 6 PK \ 026509019244

.44-.45 CALIBER  
70584 \ 6 PK \ 026509019251

**RIFLE:**

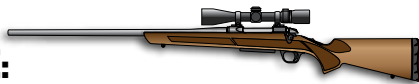

.22 CALIBER  
70580 \ 6 PK \ 026509019152

.243 CALIBER  
70588 \ 6 PK \ 026509019282

6.5 CREEDMOOR  
70590 \ 6 PK \ 026509041559

.30 CALIBER  
70581 \ 6 PK \ 026509019176

.270 - 7MM CALIBER  
70587 \ 6 PK \ 026509019275

**SHOTGUN:**

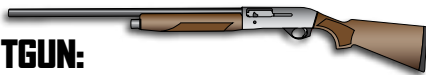

20 GAUGE  
70586 \ 6 PK \ 026509019299

12 GAUGE  
70585 \ 6 PK \ 026509019268



RIFLE



HANDGUN



SHOTGUN



**CY-CLEAN 60ct  
PROTECTANT WIPES**

- PROTECTS AGAINST RUST AND CORROSION IN ONE STEP
- LUBRICATES & CLEANS FIREARMS
- DISPLACES MOISTURE
- REMOVES FINGERPRINTS

**60 COUNT**  
**70776 \ 6 PK \ 026509027089**



**CY-CLEAN FOAMING  
BORE CLEANER**

- BREAKS DOWN FOULING WITHOUT ABRASIVE SCRUBBING
- FOAMING ACTION REACHES DEEP DOWN INTO METAL PORES
- WHITE FOAM TURNS BLUE INDICATING COPPER PRESENCE
- CONVENIENT SPRAY TUBE DIRECTS FOAM INTO BARREL

**12oz FOAM**  
**70777 \ 6 PK \ 026509027096**



**CY-CLEAN  
STORM LUBE**

- PENETRATES METAL PORES AND PROTECTS METAL PARTS
- REDUCES FRICTION AND WEAR DUE TO SURFACE CONTACT
- LUBRICATES PARTS FOR LONG LIFE AND PROPER FUNCTION
- NON-TOXIC

**4oz**  
**70774 \ 6 PK \ 026509027065**



**CY-CLEAN  
CLEANER/ DEGREASER**

- STRIPS GREASE, OIL, CARBON AND LEAD FROM GUN SURFACES
- DOES NOT HARM PLASTIC, BLUING, SEALED WOOD OR RUBBER
- LEAVES NO RESIDUE OR ODOR
- SAFE FOR ALL GUNS

**PUMP SPRAY, 4oz**  
**70775 \ 6 PK \ 026509027072**



CLEANING MAT  
PACKAGING



**NEW**  
**RUGER® HANDGUN  
RANGE AND CLEANING MAT**

- 16.75in X 11in
- SLIP RESISTANT BACK
- CLEANS EASILY WITH DAMP CLOTH
- SIGHT PICTURE GUIDE
- HOLD, GRIP CORRECTION GUIDE
- CARTRIDGE COMPARISON
- BRIGHT SPACES FOR SETTING SMALL PARTS

**70553 \ 4 PK \ 026509060789**

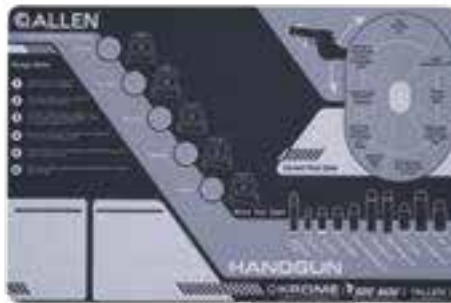

**NEW**  
**KROME™ HANDGUN  
RANGE AND CLEANING MAT**

- 17in X 11in
- SLIP RESISTANT BACK
- CLEANS EASILY WITH DAMP CLOTH
- SIGHT PICTURE GUIDE
- HOLD, GRIP CORRECTION GUIDE
- CARTRIDGE COMPARISON
- BRIGHT SPACES FOR SETTING SMALL PARTS

**70547 \ 4 PK \ 026509060604**



**NEW**  
**KROME™ RIFLE/SHOTGUN  
CLEANING MAT**

- 46in X 16in
- SLIP RESISTANT BACK
- CLEANS EASILY WITH DAMP CLOTH
- SHOTGUN CHOKE RANGE GUIDE
- RIFLE CARTRIDGE AND SHOTSHELL ANATOMY
- CARTRIDGE COMPARISON
- BULLET TRAJECTORY ILLUSTRATION

**70549 \ 4 PK \ 026509060611**

**MODERN GEAR FOR  
A TACTICAL LIFESTYLE:**

**NEW**

**UNIT TACTICAL  
2-GUN CASE, BLACK**

- HEAVY DUTY 600D MAIN EXTERIOR AND INTERIOR FABRIC, FRONT POCKET 1200D
- RAISED SILICONE HEAT TRANSFER LOGO
- LOOP PANELS FOR MORALE PATCHES
- LASER CUT MOLLE ON PADDED FRONT POCKETS
- MAGAZINE LOOPS IN LARGE FRONT POCKET
- DOUBLE COMPARTMENT TO STORE 2 FIREARMS WITH LASHING STRAPS TO SECURE EACH
- PATENT PENDING ROPE CARRY HANDLES WITH HANDLE WRAP
- DETACHABLE, ADJUSTABLE, PADDED SHOULDER STRAPS
- LOCKABLE



BLACK, 38IN  
**10838 \ 1 PK \ 026509064565**



BLACK, 46IN  
**10832 \ 1 PK \ 026509064251**



BLACK, 55IN  
**10834 \ 1 PK \ 026509064275**





COYOTE, 38<sup>IN</sup>  
**10839 \ 1 PK \**  
**026509064572**



COYOTE, 46<sup>IN</sup>  
**10833 \ 1 PK \** **026509064268**



COYOTE, 55<sup>IN</sup>  
**10844 \ 1 PK \** **026509064282**

**NEW**

**UNIT TACTICAL  
2-GUN CASE, COYOTE**

- HEAVY DUTY 600D MAIN EXTERIOR AND INTERIOR FABRIC, FRONT POCKET 1200D
- RAISED SILICONE HEAT TRANSFER LOGO
- LOOP PANELS FOR MORALE PATCHES
- LASER CUT MOLLE ON PADDED FRONT POCKETS
- MAGAZINE LOOPS IN LARGE FRONT POCKET
- DOUBLE COMPARTMENT TO STORE 2 FIREARMS WITH LASHING STRAPS TO SECURE EACH
- PATENT PENDING ROPE CARRY HANDLES WITH HANDLE WRAP
- DETACHABLE, ADJUSTABLE, PADDED SHOULDER STRAPS
- LOCKABLE



**NEW**  
**SQUAD TACTICAL  
CASE, BLACK**

- HEAVY DUTY 600D MAIN EXTERIOR AND INTERIOR FABRIC
- 1200D FRONT POCKET
- RAISED SILICONE HEAT TRANSFER LOGO
- LOOP PANELS FOR MORALE PATCHES
- LASER CUT MOLLE ON PADDED FRONT POCKETS
- MAGAZINE LOOPS IN LARGE FRONT POCKET
- SINGLE COMPARTMENT TO STORE ONE FIREARM
- PATENT PENDING ROPE CARRY HANDLES WITH HANDLE WRAP
- DETACHABLE, ADJUSTABLE, PADDED SHOULDER STRAPS
- LOCKABLE



BLACK, 46IN  
**10825 \ 1 PK \ 026509064183**



BLACK, 42IN  
**10836 \ 1 PK \ 026509064541**



BLACK, 38IN  
**10827 \ 1 PK \ 026509064206**



BLACK, 32IN  
**10829 \ 1 PK \ 026509064220**





COYOTE, 46IN  
10826 \ 1 PK \ 026509064190



COYOTE, 42IN  
10837 \ 1 PK \ 026509064558



COYOTE, 38IN  
10828 \ 1 PK \ 026509064213



COYOTE, 32IN  
10830 \ 1 PK \ 026509064237

**NEW**  
**SQUAD TACTICAL**  
**CASE, COYOTE**

- HEAVY DUTY 600D MAIN EXTERIOR AND INTERIOR FABRIC
- 1200D FRONT POCKET
- RAISED SILICONE HEAT TRANSFER LOGO
- LOOP PANELS FOR MORALE PATCHES
- LASER CUT MOLLE ON PADDED FRONT POCKETS
- MAGAZINE LOOPS IN LARGE FRONT POCKET
- SINGLE COMPARTMENT TO STORE ONE FIREARM
- PATENT PENDING ROPE CARRY HANDLES WITH HANDLE WRAP
- DETACHABLE, ADJUSTABLE, PADDED SHOULDER STRAPS
- LOCKABLE







# NEW CASES WITH VERTICAL OR HORIZONTAL CARRY OPTIONS:



BACKPACK STRAPS EASILY TUCK AWAY



CONCEAL CARRY POCKET



CONCEAL CARRY POCKET



**NEW**

## GHOST 34IN VERTICAL CASE

- HEAVY DUTY 600D MAIN EXTERIOR AND INTERIOR FABRIC
- LOOP PANELS FOR MORALE PATCHES
- DISCREET, LOCKABLE CONCEALED CARRY PISTOL POCKET WITH INCLUDED HOLSTER
- INTERIOR ORGANIZATION WITHIN LARGE FRONT POCKET
- MAIN COMPARTMENT INCLUDES LARGE PADDED POCKET AND LASHING STRAPS TO SECURE FIREARM
- TURNED & STITCHED WEBBING HANDLE WITH HANDLE WRAPS FOR VERTICAL OR HORIZONTAL CARRY OPTIONS
- PADDED BACKPACK STRAPS THAT CAN BE STORED AWAY IN BACK ZIP POCKET
- PADDED ON ALL SIDES FOR EXTRA SECURITY
- LOCKABLE

BLACK, 34 INCH

10831 \ 1 PK \ 026509064244

**NEW**

## COHORT 34IN VERTICAL CASE

- HEAVY DUTY 600D MAIN EXTERIOR AND INTERIOR FABRIC, FRONT POCKET 1200D
- LOOP PANELS FOR MORALE PATCHES
- DISCREET, LOCKABLE CONCEALED CARRY PISTOL POCKET WITH INCLUDED HOLSTER
- GREAT INTERIOR ORGANIZATION WITH LARGE FRONT POCKET
- MAIN COMPARTMENT INCLUDES LARGE PADDED POCKET AND LASHING STRAPS TO SECURE FIREARM
- TURNED & STITCHED WEBBING HANDLE WITH HANDLE WRAPS FOR VERTICAL OR HORIZONTAL CARRY OPTIONS
- LOCKABLE

BLACK, 34 INCH

10824 \ 1 PK \ 026509064176

# NEW VERICAL AND SINGLE TACTICAL GUN CASES



**NEW**  
**DIVISION**  
**TACTICAL CASE**

- MODERN SHAPE AND DESIGN
- TWO FRONT FLAT ZIP POCKETS
- HEAVY DUTY 600D EXTERIOR AND INTERIOR FABRIC
- LOOP PANEL FOR MORALE PATCHES
- LAYS COMPLETELY FLAT WHEN OPENED, CAN BE USED AS A GUN MAT/WORK AREA AS WELL
- LOCKABLE

BLACK, 46IN

**10818 \ 4 PK \ 026509064138**



BLACK, 42IN

**10835 \ 4 PK \ 026509064534**



BLACK, 38IN

**10821 \ 4 PK \ 026509064145**



BLACK, 32IN

**10823 \ 4 PK \ 026509064169**



INTERNAL BARREL  
POCKET AND STRAPS  
KEEP FIREARM SECURE



ADJUSTABLE & REMOVABLE  
SHOULDER STRAP OR  
VERTICAL CARRY

LARGE POCKETS TO  
CARRY ALL YOUR GEAR

**OVERSIZED  
LENGTH FOR  
PERFORMANCE  
RIFLES**



### GARRISON TACTICAL RIFLE CASE: 55IN

- LONGER LENGTH AND HEAVY-DUTY STITCHING FOR PERFORMANCE RIFLES
- LARGE FRONT FLAP POCKET WITH LASHING STRAPS AND REAR ZIPPER POCKET FOR GEAR
- HEAVY-DUTY FOAM FOR ADDED PROTECTION
- ADJUSTABLE, REMOVABLE SHOULDER STRAP
- DURABLE 600D POLYESTER INTERIOR WITH INTERIOR ADJUSTABLE STRAP SYSTEM
- HANGING LOOP WITH D-RING
- NOSE GRAB STRAP
- LOCKABLE

OD GREEN: 55IN

**10954 \ 4 PK \ 026509044314**

### OPERATOR GEAR FIT® TACTICAL RIFLE CASE: 44IN

- GEAR FIT® FLAP FOR LARGE GEAR OR ACCESSORIES
- MULTIPLE EXTERNAL MAGAZINE POCKETS
- PADDED STORAGE POCKET
- HOOK AND LOOP PANEL FOR MORALE PATCHES
- INTERNAL TIE DOWN STRAPS
- PADDED SHOULDER STRAP

BLACK: 44IN

**10920 \ 4 PK \ 026509026877**



### DUTY TACTICAL RIFLE CASE

- RUGGED ENDURA FABRIC
- PADDED INTERNAL ZIPPER SHIELD
- GUN SECURING STRAP SYSTEM
- ADJUSTABLE MAGAZINE POCKETS
- ZIPPERED ACCESSORY POCKET
- LOCKABLE ZIPPERS
- REMOVABLE PADDED SHOULDER STRAP

BLACK: 42IN

**10931 \ 4 PK \ 026509010968**

A-TACS AU: 38IN

**10933 \ 4 PK \ 026509010975**



**A-TACS AU**  
CAMO™  
ADVANCED TACTICAL CONCEALMENT SYSTEM





**BATTALION TACTICAL CASE**

- THREE POCKETS, DESIGNED TO HOLD 2 MAGS EACH
- FRONT AND REAR ACCESSORY POCKETS
- DETACHABLE SHOULDER STRAP WITH METAL HARDWARE
- PADDED HANDLE GRIP
- EASY TO CLEAN POLYESTER LINING

BLACK: 42IN

**10929 \ 4 PK \ 026509109297**

BLACK: 38IN

**10928 \ 4 PK \ 026509109280**



**VELOCITY RIFLE CASE**

- DUAL-DENSITY HEAVY-DUTY PADDING
- GOOD LINING
- EXTRA LONG PADDED FRONT POCKET FITS SUPPRESSORS OR OTHER ACCESSORIES
- STRETCH SLOTS ORGANIZE GEAR AND MAGS INSIDE POCKETS
- LOCKABLE ZIPPER

ATACS-IX: 55IN

**10938 \ 4 PK \ 026509026952**

BLACK: 55IN

**10949 \ 4 PK \ 026509020431**



**BATTALION DELTA TACTICAL CASE: 42IN**

- THREE MAGAZINE POCKETS HOLD 2 MAGS EACH
- THREE ROWS OF MOLLE LOOPS
- REAR ZIPPERED ACCESSORY POCKETS
- DETACHABLE SHOULDER STRAP WITH METAL HARDWARE
- PADDED HANDLE GRIP
- EASY TO CLEAN POLYESTER LINING

REAPER BLACK: 42IN

**10925 \ 4 PK \ 026509109259**



## VERSA-TAC HOME DEFENSE GUN CASE: 41IN

- RUGGED ENDURA FABRIC\EASY CLEANING LINING
- 2 EXTERNAL HOOK AND LOOP CLOSURE POCKETS
  - 16IN X 10IN TO HOLD MSR MAGAZINES
  - 14IN X 10IN ELASTIC LOOPS FOR SHOTGUN SHELLS
- PADDED CARRY HANDLE
- GUN SECURING STRAP AND CORNER POCKETS
- LOCKABLE ZIPPERS

BLACK: 41IN

**10804 \ 4 PK \ 026509108047**



## PISTOL GRIP SHOTGUN CASE: 32IN

- RUGGED ENDURA FABRIC
- 2 EXTERNAL HOOK AND LOOP CLOSURE POCKETS
- 1 EXTERNAL ZIPPER CLOSURE POCKET
- PADDED CARRY HANDLE

BLACK: 32IN

**10801 \ 4 PK \ 026509108016**



## RANGE TACTICAL RIFLE CASE

- RUGGED ENDURA FABRIC
- MAGAZINE POCKETS AND LARGE ZIP POCKET
- MORALE AND NAME LOOP PATCH
- SOFT KNIT LINING
- LOCKABLE ZIPPER

BLACK: 46IN

**10662 \ 3 PK \ 026509019077**

BLACK: 42IN

**10652 \ 3 PK \ 026509019107**

BLACK: 37IN

**10642 \ 3 PK \ 026509019121**

BLACK: 32IN

**10632 \ 3 PK \ 026509019138**





**WEDGE TACTICAL CASE**

- RUGGED ENDURA FABRIC
- THICK FOAM PADDING
- MULTIPLE EXTERNAL POCKETS
- SOFT KNIT LINING
- PADDED HOOK AND LOOP CARRY HANDLE
- LOCKABLE ZIPPERS

BLACK: 41IN

**10903 \ 4 PK \ 026509109037**

BLACK: 36IN

**10902 \ 4 PK \ 026509109020**

BLACK: 32IN

**10901 \ 4 PK \ 026509109013**



**RIOT SHOTGUN CASE: 44IN**

- HEAVY ENDURA FABRIC
- LARGE ACCESSORY POCKET
- DURABLE WEB HANDLES
- DISCREET SHAPE FOR FIREARMS

BLACK: 44IN, INTERNAL SIZE: 44IN X 11IN

**282-44 \ 3 PK \ 026509282440**



**ENGAGE TACTICAL RIFLE CASE**

- RUGGED ENDURA FABRIC\EASY CLEANING LINING
- 3 MAGAZINE POCKETS
- DURABLE WEB HANDLES
- THICK FOAM PADDING
- D-RING FOR LOCKING ZIPPER

BLACK: 42IN

**1070 \ 4 PK \ 026509010708**

BLACK: 38IN

**1080 \ 4 PK \ 026509010807**



**RESERVE TACTICAL RIFLE CASE: 38IN**

- THICK FOAM PADDING
- RUGGED ENDURA FABRIC CONSTRUCTION
- EASY CLEAN POLYESTER LINING
- THREE MAGAZINE POCKETS
- DURABLE WEB HANDLES
- D-RING FOR LOCKING THE ZIPPERS

BLACK: 38IN

**1081 \ 6 PK \ 026509057918**





**NEW**

## CREW 2-GUN TACTICAL PISTOL CASE

- DOUBLE COMPARTMENT CASE
- INTERIOR ORGANIZATION, POCKETS AND ELASTIC LOOPS FOR MAGAZINES
- BACK COMPARTMENT IS LOCKABLE AND CAN STORE TWO PISTOLS
- LASER CUT MOLLE
- LOOP PANEL FOR MORALE PATCHES
- HEAVY DUTY 600D LINING

BLACK, 10IN WIDE X 8IN HIGH X 3IN DEEP  
**10814 \ 6 PK \ 026509064114**

COYOTE, 10IN WIDE X 8IN HIGH X 3IN DEEP  
**10816 \ 6 PK \ 026509064121**



## BATTALION SINGLE HANDGUN CASE: 10IN

- NEOPRENE INTERNAL GUN POCKET
- INTERNAL STRETCH MAGAZINE STRAPS
- FILLED CARRY HANDLE
- EXTERNAL ACCESSORY POCKET
- LOCKABLE ZIPPERS
- INTERNAL SIZE: 9IN X 7IN

ATACS-AU: 10IN, INTERNAL SIZE: 9IN X 7IN  
**10941 \ 4 PK \ 026509011132**

BLACK: 10IN, INTERNAL SIZE: 9IN X 7IN  
**10940 \ 4 PK \ 0265090111011.7**



**A-TACS AU**  
CAMO™  
ADVANCED TACTICAL CONCEALMENT SYSTEM



**NEW**

**CONTINGENT  
TACTICAL ACCESSORY POUCH**

- LASER CUT MOLLE
- HEAVY DUTY BACK MOLLE COMPATIBLE WEBBING STRAPS WITH SNAPS
- INTERIOR POCKETS AND ORGANIZATION
- DURABLE 600D EXTERIOR

BLACK, 9IN WIDE X 5IN HIGH X 3IN DEEP  
**10808 \ 6 PK \ 026509064077**

COYOTE, 9IN WIDE X 5IN HIGH X 3IN DEEP  
**10809 \ 6 PK \ 026509064091**



**NEW**

**DETACHMENT  
TACTICAL ACCESSORY POUCH**

- LASER CUT, HEAVY DUTY "RIP-AWAY" BACK MOLLE
- COMPATIBLE SYSTEM WITH WRAPAROUND SIDE RELEASE BUCKLE FOR EXTRA SECURITY
- INTERIOR POCKETS AND ORGANIZATION

BLACK, 9IN WIDE X 5IN HIGH X 3IN DEEP  
**10810 \ 6 PK \ 026509064084**

COYOTE, 9IN WIDE X 5IN HIGH X 3IN DEEP  
**10812 \ 6 PK \ 026509064107**



EASY REMOVE BACK PANEL:



## COMMAND TACTICAL PACK: 20in 2260 CU IN CAPACITY (37 L)

- SPACIOUS MAIN COMPARTMENT FEATURES EASY ACCESS FLAP ORGANIZER POCKETS AND PADDED SLEEVES FOR A LAPTOP AND TABLET
- OVERSIZED ZIPPERED SIDE POCKETS
- SOFT PADDED HANDLE AND STRAP FOR COMFORT
- DIE-CUT MOLLE VELCRO PANEL
- OVERSIZED ZIPPERED SIDE POCKETS WITH BUILT-IN ORGANIZERS FOR CABLES, CORDS AND OTHER LOOSE ITEMS
- PADDED CARRY HANDLE
- FLAT FRONT POCKET WITH WATERPROOF ZIPPER AND SOFT BRUSHED LINING
- LOCKING AMBIDEXTROUS CONCEAL CARRY POCKET WITH ADJUSTABLE HOLSTER AND MAGAZINE HOLDER
- 20.5in X 14in X 9.5in

HEATHER GREY

10884 \ 3 PK \ 026509043430



SMOOTH NO RUB  
NECK PANELS

PADDED BACK  
PANELS FOR  
COMFORT &  
AIRFLOW



CONCEAL  
CARRY  
POCKET



## POST TACTICAL PACK: 19in 1929 CU IN CAPACITY ( 31.6 L)

- HOLDS A LARGE LAPTOP, TABLET AND ACCESSORIES
- ELASTIC SIDE MESH POCKETS
- PARACORD TOP HANDLE AND ZIPPER PULLS
- DIE-CUT MOLLE VELCRO PANEL
- ZIPPERED MIDDLE POCKET WITH BUILT-IN ORGANIZER FOR CABLES AND CORDS, PENS, CELL PHONE AND OTHER LOOSE ITEMS
- FRONT POCKET FEATURES LARGE ZIPPERED POCKETS AND CLIP TO KEEP KEYS ACCESSIBLE
- SPACIOUS MAIN COMPARTMENT WITH PADDED SLEEVES FOR A LAPTOP AND TABLET
- BREATHABLE, PADDED MESH BACK PANELS
- LOCKING AMBIDEXTROUS CONCEAL CARRY POCKET WITH ADJUSTABLE HOLSTER AND MAGAZINE HOLDER
- 19.25in X 1.5in X 7in

GREY/BLACK

10883 \ 3 PK \ 026509043423

PARACORD  
TOP HANDLE



SMOOTH NO RUB  
NECK PANELS

PADDED BACK  
PANELS FOR  
COMFORT &  
AIRFLOW

DIE-CUT MOLLE  
VELCRO PANEL



CONCEAL  
CARRY  
POCKET



## CAMP TACTICAL PACK: 17in 1607 CU IN CAPACITY ( 26.3 L)

- HOLDS A LARGE LAPTOP, TABLET AND ACCESSORIES
- INNOVATIVE TIGHTENING SYSTEM SECURES INTERNAL AND EXTERNAL ITEMS
- PARACORD TOP HANDLE AND EASY GRAB ZIPPER PULLS
- FOUR LARGE INTERNAL POCKETS
- LOW PROFILE EXTERNAL POCKETS TO ORGANIZE GEAR
- LOCKING AMBIDEXTROUS CONCEAL CARRY POCKET WITH ADJUSTABLE HOLSTER AND MAGAZINE HOLDER
- ZIPPERED FRONT POCKET WITH BUILT-IN ORGANIZER FOR CABLES AND CORDS, KEYS, PENS, CELL PHONE AND OTHER LOOSE ITEMS
- PADDED SHOULDER STRAPS WITH SMOOTH NO-RUB NECK PANELS, WEBBING LOOPS AND AN ADJUSTABLE CHEST STRAP
- 17.5in X 13.5in X 7in

BLACK

10882 \ 3 PK \ 026509043416

GREEN/BLACK

10887 \ 3 PK \ 02650904604247



PARACORD  
TOP HANDLE



SMOOTH NO RUB  
NECK PANELS

ELASTIC  
SIDE POCKETS



CONCEAL  
CARRY  
POCKET









## EXPANDABLE MAIN COMPARTMENT



### TRENCH TACTICAL PACK: 19IN 1254 / 2166 CU IN CAPACITY (35.5 L)

- TALL FORMAT EXPANDING PACK
- ZIPPERED EXPANSION PANEL INCREASES THE PACK CAPACITY DEPTH BY 4 INCHES (10.16CM) OR 912 CUBIC INCHES
- DIE-CUT MOLLE FRONT PANEL
- SIDE COMPRESSION STRAPS TO KEEP YOUR ESSENTIALS TIGHTLY PACKED
- PADDED CARRY HANDLE
- PADDED SHOULDER STRAPS WITH ADJUSTABLE STERNUM STRAP
- MESH POCKETS EXPOSED WHEN PACK IS EXPANDED
- SPACIOUS MAIN COMPARTMENT AND FRONT ACCESSORY POCKET WITH ORGANIZER
- 19IN X 11IN X 6IN COMPRESSED
- 19IN X 11IN X 10IN EXPANDED

TAN

10889 \ 3 PK \ 026509054337

### BERM TACTICAL PACK: 17IN 1683 CU IN CAPACITY (27.6 L)

- SPACIOUS MAIN COMPARTMENT AND TWO ACCESSORY POCKETS
- SIDE MESH POCKET
- MOLLE CONNECTION SYSTEM
- SIDE COMPRESSION STRAPS TO KEEP YOUR ESSENTIALS TIGHTLY PACKED
- PADDED CARRY HANDLE
- PADDED SHOULDER STRAPS WITH ADJUSTABLE STERNUM STRAP
- PADDED LAPTOP AND TABLET SLEEVES
- 17IN X 11IN X 9IN

BLACK

10888 \ 3 PK \ 026509054320







### INTERCEPT TACTICAL PACK: 18.5IN 2500 CU IN CAPACITY (40.9 L)

- RUGGED ENDURA FABRIC
- MULTIPLE EXTERNAL ACCESSORY POCKETS
- MOLLE WEB SYSTEM
- COMPRESSION STRAPS
- COOL MESH BACK
- PADDED SHOULDER STRAPS WITH ADJUSTABLE STERNUM STRAP
- INTERNAL ORGANIZER COMPARTMENTS
- HYDRATION COMPATIBLE
- SIDE CARRY HANDLES
- 18.5IN X 16IN X 10IN

TAN

10858 \ 4 PK \ 026509012542



### LITE FORCE TACTICAL SLING PACK: 18IN 1200 CU IN CAPACITY (19.7 L)

- SLING DESIGN GIVES ACCESS TO THE PACK WITHOUT REMOVING IT
- RUGGED ENDURA FABRIC WITH PADDED ADJUSTABLE SINGLE SLING STRAP
- CONCEAL CARRY COMPATIBLE
- MOLLE SYSTEM LOOPS
- WATER BOTTLE & SUNGLASSES POCKETS
- LARGE MAIN COMPRESSION STRAP
- HYDRATION COMPATIBLE
- 18IN X 9.75IN X 7.5IN

TAN

10855 \ 4 PK \ 026509012504

BLACK

10854 \ 4 PK \ 026509012481





**SPORTER RANGE BAG**

- DETACHABLE SHOULDER STRAP
- PADDED PISTOL RUG
- 15IN X 8IN X 8.5IN MAIN COMPARTMENT
- HARD BOTTOM LINER
- 12IN X 6IN X 1IN EXTERIOR POCKET
- TWO ROWS OF MOLLE LOOPS

BLACK

**8247 \ 4 PK \ 026509035268**

**TACTICAL GUN SOCK**

- LIMITED SILICONE TREATMENT FOR SHORT-TERM PROTECTION
- FITS SCOPED AND NON-SCOPED TACTICAL FIREARMS
- CINCH CLOSURE

BLACK: 42IN

**13242 \ 6 PK \ 026509132424**

BLACK: 47IN

**13247 \ 6 PK \ 026509132479**

BLACK: 55IN

**13255 \ 6 PK \ 026509044208**



# RANGE BAG & TACTICAL GUN ACCESSORIES



## PACKAGING



### CITADEL SINGLE/ DOUBLE POINT SLING

- CONVERTIBLE, SINGLE TO TWO POINT ATTACHMENT SLING
- QUICK SNAP HOOK ATTACHMENT
- ELASTIC COVERED HOOKS
- HEAVY WEIGHT WEB CONSTRUCTION
- TESTED TO A 200-POUND LOAD
- ADJUSTS TO 50-INCHES

8911 \ 6 PK \ 026509089117



### CITADEL SINGLE/ DOUBLE POINT SLING

- NEW MATERIALS ADD COMFORT TO PARACORD DESIGN
- THE ADDITION OF ELASTIC ADDS CUSHIONING EFFECT
- HEAVY-DUTY SWIVELS AND HARDWARE ON BOTH SLINGS
- SINGLE POINT SLING HAS A TWO POSITION OPTION AS WELL

8914 \ 6 PK \ 026509035169



### CITADEL PARACORD SINGLE/DOUBLE POINT RIFLE SLING

- HEAVY DUTY 1.5IN WEB CONSTRUCTION
- SCISSOR STYLE ATTACHMENT HOOK
- ADJUSTABLE FROM 42IN TO 54IN

8492 \ 3 PK \ 026509019893



### CITADEL SINGLE/DOUBLE POINT RIFLE SLING

- CONVERTIBLE SINGLE TO TWO POINT ATTACHMENT
- ELASTIC COVERED HOOKS ADJUSTS TO 50IN
- INCLUDES QD SWIVEL

8491 \ 6 PK \ 026509017578



### CITADEL SINGLE POINT RIFLE SLING

- HEAVY DUTY 1.5IN WEB CONSTRUCTION
- SCISSOR STYLE ATTACHMENT HOOK
- ADJUSTABLE FROM 42IN TO 54IN

8910 \ 6 PK \ 026509089100



### RAIL MOUNT SWIVEL STUD

- FITS ALL PICATINNY AND WEAVER RAILS
- LIGHTWEIGHT ALUMINUM CONSTRUCTION
- INCLUDES ALLEN WRENCH

14494 \ 3 PK \ 026509144946



### QD SWIVELS: 1.25IN

- PUSH BUTTON SWIVEL DESIGN
- 1.25IN MOUNTING LOOP
- SET OF TWO SWIVELS

14516 \ 6 PK \ 026509046097

## PACKAGING





## RUGER® TACTICAL SHOOTING MAT-CASE: 50IN

- FITS SCOPED RIFLES UP TO 50IN
- OPENS TO 70IN X 37IN FULL SHOOTING MAT
- 600D GRAY LINING HELPS REDUCE HEAT WHILE SHOOTING
- GRIP PANELS HELP KEEP YOU STEADY
- PADDED REMOVABLE BACKPACK STRAPS
- INTERNAL BARREL POCKET, GUN STRAPS
- ORGANIZER FLAPS FOR SHELLS AND BALLISTIC CARDS
- DURABLE WEB DRAG HANDLE
- HEAVY-DUTY PADDING
- LOOP PANEL FOR NAME PLATE AND MORALE PATCHES
- MOLLE PANELS FOR ACCESSORIES
- LOCKABLE ZIPPERS

BLACK 50IN, INTERNAL SIZE: 50IN X 11.5IN

**27990 \ 2 PK \ 026509019756**



## RUGER® DEFIANCE TACTICAL RIFLE CASE: 42IN

- EXTRA-RUGGED ENDURA FABRIC
- MAGAZINE AND MULTIPLE ACCESSORY POCKETS
- SOFT KNIT LINING
- PADDED CARRY HANDLE
- LOCKABLE ZIPPERS

BLACK 42IN, INTERNAL SIZE: 42IN X 11IN

**27932 \ 4 PK \ 026509011040**



**NEW**

## RUGER® TEMPE 40IN TACTICAL RIFLE CASE

- DURABLE INTERIOR AND EXTERIOR FABRIC
- ZIPPERED FRONT POCKET
- BLACKOUT RUGER LOGO

BLACK 40IN, INTERNAL SIZE: 40IN X 11IN

**27805 \ 4 PK \ 026509063872**







**RUGER® PIMA TACTICAL PACK**  
**1449 CU IN (23.7L)**

- CONCEAL CARRY PACK WITH LOCKABLE CONCEAL CARRY, LEFT/RIGHT ACCESSIBLE POCKETS
- DELUXE PACK FEATURES TWO EXTERNAL ZIPPERED POCKETS AND TWO SIDE MESH POCKETS
- DIE-CUT MOLLE PANELS
- PADDED MESH BACK FOR VENTILATION AND COMFORT
- SOFT paneled STRAPS WITH WEBBING LOOPS AND STERNUM STRAP
- DELUXE INTERIOR ORGANIZER WITH DIE CUT MOLLE, LAPTOP AND IPAD SLEEVES AND ZIPPERED POCKET
- SUBTLE BRANDING AND MODERN DESIGN
- 11.5IN X 6IN X 21IN

GREY

**27802 \ 2 PK \ 026509051596**



**RUGER® DOUBLE HANDGUN CASE : 12.5IN**

- EXTRA-RUGGED ENDURA FABRIC
- INTERNAL MAGAZINE HOLDERS
- TWO INTERNAL HANDGUN COMPARTMENTS
- HOOK AND LOOP CLOSE CARRY HANDLE
- EXTERIOR MOLLE WEB SYSTEM
- DENSE FOAM PADDING
- LOCKABLE ZIPPERS

BLACK, INTERNAL SIZE: 12.5IN X 8IN

**27959 \ 4 PK \ 026509012634**





**RUGER® BASTION  
RIFLE CASE: 55IN**

- 55IN PERFORMANCE RIFLE CASE
- LONGER LENGTH AND HEAVY-DUTY STITCHING FOR PERFORMANCE RIFLES
- FRONT ACCESSORY POCKETS
- HEAVY-DUTY FOAM FOR ADDED PROTECTION
- BUILT-IN SHOULDER STRAP
- DURABLE 600 D POLYESTER INTERIOR
- INTERIOR ADJUSTABLE STRAP SYSTEM
- HANGING LOOP WITH D-RING
- LOCKABLE

BLACK

**29729 \ 4 PK \ 026509044321**



LONGER LENGTH FOR PRECISION RIFLES

**RUGER® AMERICAN  
RIFLE CASE: 46IN**

- FOR 46 INCH SCOPED RIFLES
- THICK FOAM PADDING FOR PROTECTION
- FRONT ZIP ACCESSORY POCKET
- LOCKABLE
- SOFT KNIT LINING

BLACK/GREY

**29735 \ 4 PK \ 026509044741**



**RUGER® FLAGSTAFF  
10/22® RIFLE CASE: 40IN**

- THREE ACCESSORY POCKETS
- PADDED CARRY HANDLE
- EASY CLEAN LINING
- LOCKABLE ZIPPERS
- RUGGED ENDURA FABRIC

BLACK

**375-40 \ 4 PK \ 026509375401**



**RUGER® PRESCOTT  
HERITAGE RIFLE CASE: 46IN**

- 12oz COTTON CANVAS QUILTED MATERIAL WITH SUEDE TRIM
- ADJUSTABLE AND REMOVABLE SHOULDER STRAP
- PADDED HANDLES
- LARGE REAR POCKET
- HANGING D-RING
- LOCKING CASE

TAN

**29733 \ 4 PK \ 026509044727**



SEE NEXT PAGE FOR MATCHING HANDGUN CASE

**RUGER® YUMA 10/22®  
RIFLE CASE: 40IN**

- DESIGNED TO FIT RUGER® 10/22® MODELS WITH OR WITHOUT A SCOPE
- DENSE FOAM PADDING
- DURABLE ENDURA EXTERIOR
- 3 EXTERIOR POCKETS
- OVERSIZED RUGER® SCREENPRINT.
- LOCKING CASE

BLACK

**29732 \ 4 PK \ 026509044710**





**RUGER® AMERICAN RIFLE CASE: 46IN**

- RUGGED ENDURA FABRIC
- ACCESSORY POCKET
- THICK FOAM PADDING
- LOCKABLE ZIPPERS

GREY  
27433 \ 6 PK \ 026509012337



**RUGER® MESA RIFLE CASE: 46IN**

- RUGGED ENDURA FABRIC
- DENSE FOAM PADDING
- ZIPPERED GUSSET POCKET
- LOCKING ZIPPER
- HANGING LOOP

BLACK  
274-46 \ 4 PK \ 026509039488



**RUGER® RIFLE CASE: 48IN**

- ZIPPERED ACCESSORY POCKET
- DENSE FOAM PADDING
- RUGGED ENDURA FABRIC
- INTERNAL SIZE: 40IN X 9IN

BLACK  
27140 \ 6 PK \ 026509271406



**RUGER® EMBROIDERED 10/22® RIFLE CASE: 40IN**

- DENSE FOAM PADDING
- SELF-HEALING ZIPPER
- RUGGED ENDURA FABRIC
- LOCKING

BLACK  
275-40 \ 6 PK \ 026509275404



FITS: RUGER® PC CARBINES AND 10/22 TAKEDOWN® MODELS

**RUGER® BLACKWATER TAKEDOWN CASE: 25IN**

- RUGGED ENDURA FABRIC
- TAKEDOWN FORMAT WITH SEPARATE COMPARTMENTS
- PADDED HANDLES
- LARGE REAR POCKET
- HANGING D-RING
- LOCKING CASE

GREY  
29734 \ 4 PK \ 026509044734





**NEW**

**RUGER® PHOENIX HARDSHELL  
HANDGUN CASE 7IN**

- MOLDED CARRYING HANDLE
- THERMO-MOLDED EXOSKELETON
- MICRO EGG CRATE FOAM INTERIOR
- HEAVY-DUTY LOCKABLE ZIPPERS
- BRUSHED METAL NAMEPLATE

7 INCH

**27503 \ 4 PK \ 026509064527**



**NEW**

**RUGER® PHOENIX HARDSHELL  
HANDGUN CASE 9IN**

- MOLDED CARRYING HANDLE
- THERMO-MOLDED EXOSKELETON
- MICRO EGG CRATE FOAM INTERIOR
- HEAVY-DUTY LOCKABLE ZIPPERS
- BRUSHED METAL NAMEPLATE

9 INCH

**27502 \ 4 PK \ 026509064510**



**RUGER® PRESCOTT  
HERITAGE PISTOL CASE: 9IN**

- COMPACT AUTO-FIT PISTOL CASE (INTERNAL SIZE: 9" X 7")
- COTTON CANVAS EXTERIOR FABRIC
- OVERSIZED QUILTING
- SPLIT LEATHER ACCENT PANEL
- THICK FOAM PADDING
- LOCKABLE ZIPPER
- DEBOSSSED LOGO

**27501 \ 4 PK \ 026509044680**



**ONE-POCKET RUGER®  
AUTO-FIT HANDGUN CASE: 9IN**

- RUGGED ENDURA FABRIC
- THICK FOAM PADDING
- STORAGE POCKET FOR ACCESSORIES
- LOCKABLE ZIPPER
- SOFT KNIT LINING
- INTERNAL SIZE: 9IN X 7IN

**27430 \ 4 PK \ 026509274308**



**RUGER® WRANGLER  
REVOLVER CASE: 11IN**

- COTTON CANVAS AND FAUX LEATHER EXTERIOR
- PLUSH FLEECE LINING
- IMPRINTED RUGER LOGO
- D-RING
- 11 INCH PISTOL CASE

**27804 \ 4 PK \ 026509056164**

**RUGER® TUCSON  
HANDGUN CASES**

- FITS MOST HANDGUNS UP TO 10IN AND 8IN IN LENGTH
- EXTERIOR STORAGE POCKET
- BARREL-PROTECTING POCKET
- SOFT KNIT LINING
- LOCKABLE ZIPPER

10IN X 6.75IN GRAY\RED

**27401 \ 4 PK \ 026509012375**

8IN X 5.75IN GRAY\RED

**27408 \ 4 PK \ 026509012344**

8IN X 5.75IN GRAY\ORCHID

**27409 \ 4 PK \ 026509012368**





**RUGER® RANGE BAG**

- REMOVABLE PISTOL RUG
  - 6 MAGAZINE POCKETS
  - REMOVABLE AMMO CARRIER
  - DETACHABLE SHOULDER STRAP
- BLACK

27450 \ 2PK \ 026509274506



FITS:  
RUGER® 10/22  
TAKEDOWN®

**NEW**

**RUGER® 10/22® PACK**

- STOCK AND BARREL POCKETS FOR RUGER® TAKEDOWN RIFLES
- INTERIOR ORGANIZATION FOR AMMO, MAGAZINES AND ACCESSORIES
- ADJUSTABLE SLING STRAP FOR LEFT OR RIGHT CARRY

GRAY

29736 \ 2 PK \ 026509065265



**NEW**

**RUGER® PISTOL POUCH**

- WRITEABLE ID LABEL
- CUSHIONED FLEECE LINING
- EASY OPEN ZIPPER
- LOCKABLE

BLACK, COMPACT, 5IN X 7IN

27504 \ 6 PK \ 026509064916

BLACK, FULL SIZE, 7IN X 9IN

27505 \ 6 PK \ 026509064923



**RUGER® HANDGUN SOCK: 14IN**

- FITS MOST HANDGUNS UP TO 14IN
- SILICONE TREATED FOR RUST PROTECTION
- STRETCH KNIT FABRIC
- DRAWSTRING CLOSURE

GRAY

27133 \ 12 PK \ 026509019749



**RUGER® 10/22® GUN SOCK: 40IN**

- FITS MOST .22 RIFLES WITH OR WITHOUT SCOPES UP TO 40IN
- SILICONE TREATED FOR RUST PROTECTION
- STRETCH KNIT FABRIC

GRAY

27132 \ 12 PK \ 026509019732



**RUGER® KNIT GUN SOCK: 52IN**

BLACK

13401 \ 12 PK \ 026509134015



### RUGER® BOULDER RUBBER SLING

- LIGHTWEIGHT RUBBER
- RUBBER FORMING GRIP DESIGN
- QUICK, ONE HAND ADJUSTMENT SWIVELS TESTED TO 500LBS
- THUMB LOOP

BLACK  
27600 \ 6 PK \ 026509043027



### RUGER® MESA NEOPRENE SLING W\ SWIVELS

- STRETCHABLE NEOPRENE BODY FOR ADDED COMFORT
- ELASTIC CENTER SECTION TO REDUCE STRETCH
- STICKY BACK REDUCES SLIP
- SWIVELS TESTED TO 300 POUNDS

BLACK  
27834 \ 6 PK \ 026509018148



### RUGER® SUMMIT ULTRALITE SLING

- LOW-DENSITY FOAM COVERED BY RUGGED FABRIC
- NON-SLIP TEXTURED BACK
- HEAVY-DUTY WEB SLING
- SWIVELS TESTED TO 300 POUNDS

BLACK  
27830 \ 6 PK \ 026509010111



### RUGER® PADDED 10/22® SLING

- LIGHT WEIGHT CONSTRUCTION
- NON SLIP, TEXTURED BACK
- SWIVELS TESTED TO 500LBS
- LOW-DENSITY FOAM COVERED BY RUGGED FABRIC

BLACK  
27602 \ 6 PK \ 026509043058



### RUGER® 10\22® RIFLE SLING

- HEAVY-DUTY 1.25in WEB CONSTRUCTION
- ADJUSTABLE BUCKLE SLIDES TO FIT MOST RIFLES
- SWIVELS TESTED TO 300 POUNDS

BLACK  
27838 \ 6 PK \ 026509278382







**NEW**  
**RUGER® 10/22® STEEL SPINNER TARGET**

- DESIGNED FOR RIMFIRE AND AIR RIFLES
- 3/16IN THICK STEEL SPINNER
- 2-1/2IN AND 1-3/4IN WIDE TARGETS
- FOLDING STAND
- ADAPTABLE TO THE ALLEN CUSTOM TARGET SYSTEM

70577 \ 6 PK \ 026509060895



**NEW**  
**RUGER® 10/22® SPLASH ADHESIVE TARGET KIT**

- SPLASH TECHNOLOGY FOR VISIBLE IMPACT
- 12.5IN X 12.5IN ADHESIVE TARGETS
- ADHESIVE BACK FOR EASY ATTACHMENT TO BACKSTOPS
- BULLET HOLES SHOW BRIGHT CHARTREUSE
- 3 TARGETS INCLUDED

12.5IN X 12.5IN  
 28001 \ 12 PK \ 026509061663

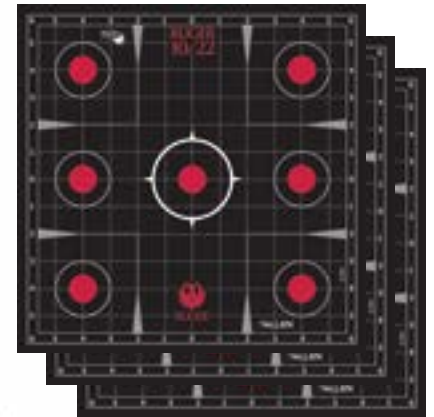

**NEW**  
**RUGER® 10/22® SPLASH ADHESIVE TARGET KIT, 12.5IN X 12.5IN, 5 PACK**

- GREAT FOR PLINKING OR SIGHT-IN
- SPLASH TECHNOLOGY SHOWS BRIGHT CHARTREUSE HALO AROUND BULLET HOLE
- ADHESIVE BACK FOR EASY ATTACHMENT TO BACKSTOPS
- SEVEN, 1 INCH AIMING SPOTS
- GRID PATTERN FOR EASY SCOPE AND SIGHT ADJUSTMENTS
- 5 TARGETS PER PACK

12.5IN X 12.5IN  
 27991 \ 12 PK \ 026509060901



**NEW**  
**RUGER® PAPER HANDGUN TRAINER TARGET 12IN X 18IN**

- 20 TARGETS PER PACK
- HANDGUN SHOOTING CORRECTIVE TIPS
- RED, BLACK AND WHITE PRINT
- 12IN X 18IN TARGET SURFACE

27999 \ 12 PK \ 026509061656



**NEW**  
**RUGER® SPLASH ADHESIVE HANDGUN TRAINER 12IN X 18IN**

- SPLASH TECHNOLOGY FOR VISIBLE IMPACT
- ADHESIVE BACK FOR EASY TARGET INSTALLATION
- COACHING TIPS HELP CORRECT SHOOTING PROBLEMS
- 12.5IN X 18.5IN SURFACE
- 5 TARGETS PER PACK

27998 \ 12 PK \ 026509061649



**NEW**  
**RUGER® PAPER TARGET SEVEN SPOT PRECISION SIGHT IN 17IN X 17IN**

- 20 TARGETS PER PACK
- ONE-INCH GRID PATTERN FOR SIGHT-IN
- SEVEN, ONE-INCH AIMING SPOTS
- 17IN X 17IN TARGET SURFACE

27992 \ 12 PK \ 026509060918



**NEW**  
**RUGER® 10/22® PASSIVE MUFF & SHOOTING GLASSES COMBO**

- HIGH IMPACT POLYCARBONATE LENS
- SCRATCH RESISTANT COATING
- GLASSES: ANSI Z87.1+ RATED
- NRR PROTECTION OF 23DB

70573 \ 3 PK \ 026509060840



**NEW**  
**RUGER® 10/22® FOAM PLUG & SHOOTING GLASSES COMBO**

- HIGH IMPACT POLYCARBONATE LENS
- SCRATCH RESISTANT LENS
- GLASSES: ANSI Z87.1+ RATED
- NRR PROTECTION OF 32DB

70579 \ 4 PK \ 026509064862



**NEW**  
**RUGER® 10/22® FOAM EAR PLUGS, 6 PAIRS**

- NRR 32DB HEARING PROTECTION
- ANSI S3.19 AND CE EN352-2 RATED
- MOLDABLE FOR A CUSTOM FIT EVERY TIME

70563 \ 6 PK \ 026509060826



**NEW**  
**RUGER® 10/22® PASSIVE SAFETY MUFF**

- NRR 21
- LOW PROFILE CUP DESIGN
- ADJUSTABLE PADDED HEADBAND
- SOFT FOAM LINED EAR MUFFS

70571 \ 3 PK \ 026509060833

**RUGER® 10/22® BUTTSTOCK POUCH**

- PROTECTIVE FLAP
- ZIPPERED STORAGE POCKET
- EASY/QUIET ELASTIC CLOSURE
- FITS 10 ROUND MAGAZINES AND AMMO

BLACK

27222 \ 6 PK \ 026509008330



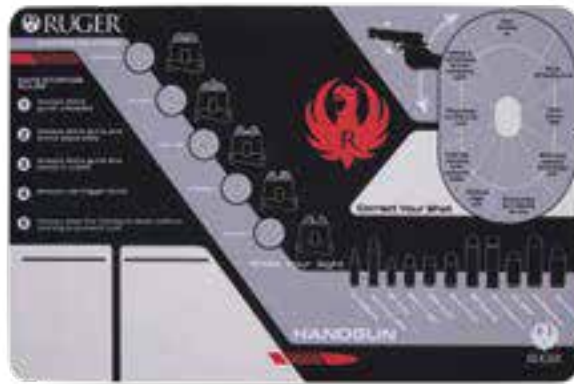

**NEW**  
**RUGER® HANDGUN RANGE  
AND CLEANING MAT**

- SLIP RESISTANT BACK
  - CLEANS EASILY WITH A DAMP CLOTH
  - SIGHT PICTURE GUIDE
  - HOLD, GRIP CORRECTION GUIDE
  - BRIGHT SPACES FOR SETTING SMALL PARTS
- 70553 \ 4 PK \ 026509060789**



**RUGER® RIMFIRE  
CLEANING KIT**

- HIGH QUALITY RIMFIRE CLEANING KIT  
PACKED IN A MOLDED TOOL BOX.  
KIT INCLUDES:
- .22 AND .204 CALIBER CLEANING BRUSHES
  - TWO SIZES OF PATCHES
  - SOLID BRASS JAGS AND SLOTTED TIPS
  - BRONZE BRUSHES
  - COTTON SWABS
- 27822 \ 3 PK \ 026509009245**



**RUGER® UNIVERSAL HANDGUN  
CLEANING KIT**

- HIGH QUALITY HANDGUN CLEANING KIT  
PACKED IN A MOLDED TOOL BOX.  
FOR HANDGUNS: .380ACP, .357 MAGNUM, .38 SPECIAL,  
9MM, 10MM, .40 CALIBER, .44 MAGNUM AND .45ACP  
KIT INCLUDES:
- HEAVY-DUTY BRASS CLEANING ROD
  - BRASS JAGS
  - BRASS SLOTTED TIP AND ADAPTER
  - BRONZE BORE BRUSHES
  - COTTON BORE SWABS
  - 20 COTTON CLEANING PATCHES
  - MUZZLEGUARD
- 27836 \ 3 PK \ 026509009306**



**RUGER® COMPACT HANDGUN  
CLEANING KIT**

- HIGH QUALITY HANDGUN CLEANING KIT  
PACKED IN A MOLDED TOOL BOX.  
KIT INCLUDES:
- BRONZE BRUSHES FOR .38 SPECIAL/  
.357/9MM, .40 AND .45 CALIBER
  - COTTON SWABS
  - SLOTTED TIPS
- 27821 \ 3 PK \ 026509009238**



**RUGER® RIFLE/HANDGUN  
CLEANING KIT**

- HIGH QUALITY RIFLE AND HANDGUN CLEANING KIT  
PACKED IN A MOLDED TOOL BOX  
KIT INCLUDES:
- CLEANING JAGS FOR .45, .40, .357/9MM, .30,  
.284/7MM, .270, .25, .243, AND .22 CALIBER
  - BRONZE BORE BRUSHES FOR .45, .40, .357/  
9MM, .30, .270, .25, .243, AND .22 CALIBER
  - HEAVY-DUTY BRASS CLEANING ROD
  - BRASS SLOTTED TIPS FOR .22 AND .30 CALIBER
  - BRASS ADAPTER
  - COTTON CLEANING PATCHES; 2IN, 1.25IN AND .875IN
  - MUZZLEGUARD
- 27825 \ 3 PK \ 026509009276**



**RUGER® RIFLE/SHOTGUN  
CLEANING KIT**

- HIGH QUALITY RIFLE AND SHOTGUN CLEANING KIT  
PACKED IN A MOLDED TOOL BOX  
KIT INCLUDES:
- PREMIUM 4-PIECE BRASS CLEANING ROD
  - SHOTGUN BRUSHES FOR 12 AND 20 GAUGE
  - SHOTGUN SWABS FOR 12 AND 20 GAUGE
  - 20 COTTON CLEANING PATCHES
  - BRUSHES FOR .22, .243, .270  
AND .30 CALIBER
  - BRUSHES FOR .357/9MM CALIBER
  - SLOTTED TIPS FOR .22, RIFLE AND  
SHOTGUN CALIBER
- 27826 \ 3 PK \ 026509009283**



ALLEN IS PROUD TO PARTNER WITH GIRLS WITH GUNS® ON AN EXCLUSIVE LINE OF ACCESSORIES.



**GIRLS WITH GUNS® FOILED RIFLE CASE, 46IN**

- LARGE FRONT ZIP POCKET
- HEAVY-DUTY FOAM
- LOCKABLE ZIPPER

GOLD FOIL, RIFLE, 46IN

90-46 \ 4 PK \ 026509047612



**GIRLS WITH GUNS® TEN POINT DREAMS RIFLE CASE, 46IN**

- LARGE FRONT ZIP POCKET
- HEAVY-DUTY FOAM
- LOCKABLE ZIPPER

SHADE™, RIFLE, 46IN

91-46 \ 4 PK \ 026509047605



**GIRLS WITH GUNS® MIDNIGHT GUN CASES**

- FLAP POCKET FOR ACCESSORIES
- DURABLE LINING
- LOCKABLE

SHADE™ BLACKOUT CAMO, RIFLE, 46IN

907-46 \ 4 PK \ 026509054399

SHADE™ BLACKOUT CAMO, SHOTGUN 52IN

907-52 \ 4 PK \ 026509054405



**NEW**

**GWG® ROSES ARE GOLD PISTOL CASE**

- FITS HANDGUNS UP TO 10IN IN LENGTH
- THICK FOAM PADDING
- LOCKABLE ZIPPER

9072 \ 6 PK \ 026509064657

FITS 1-11



**NEW**

MADE IN THE USA 

**GWG® FREEDOM PISTOL CASE**

- FITS HANDGUNS UP TO 10IN IN LENGTH
- THICK FOAM PADDING
- LOCKABLE ZIPPER

9071 \ 6 PK \ 026509064640

FITS 1-11



**NEW**

MADE IN THE USA 

**GWG® LOVE PISTOL CASE**

- FITS HANDGUNS UP TO 10IN IN LENGTH
- THICK FOAM PADDING
- LOCKABLE ZIPPER

9075 \ 6 PK \ 026509065173

FITS 1-11

**GWG® HANDGUN CASES**

- HEAVY-DUTY FOAM
- HANGING LOOP WITH D-RING
- LOCKABLE



BLACKOUT CAMO  
907-8 \ 6 PK \ 026509054382

FITS 1-7



SHADE™, HANDGUN, 8IN  
91-8 \ 6 PK \ 026509047650

FITS 1-7



GOLD FOIL, HANDGUN, 8IN  
90-8 \ 6 PK \ 026509047636

FITS 1-7



GRAY - COMPACT - 5IN x 7IN  
9073 \ 6 PK \ 026509064930



GRAY - FULLSIZE - 7IN x 9IN  
9074 \ 6 PK \ 026509064947

**NEW**

**GWG® PISTOL POUCHES**

- WRITEABLE ID LABEL
- CUSHIONED FLEECE LINING
- EASY OPEN ZIPPER
- LOCKABLE





*Concealed Casual*  
BY  
GIRLS WITH GUNS

**DESIGNED BY WOMEN,  
FOR WOMEN**



**CONCEAL CARRY  
HANDBAGS**

**GWG<sup>®</sup> COSMIC LARGE  
CONCEAL CARRY TOTE**

- CONCEAL CARRY POCKET ON FRONT WITH MAGNETIC CLOSURE AND LOCKABLE ZIPPERS
- BACK FLAT POCKET FOR SMALL ACCESSORIES
- OVER THE SHOULDER CARRY HANDLE
- INTERIOR ORGANIZATION IN THE MAIN COMPARTMENT
- INSULATED, SIDE ACCESS POCKET KEEPS DRINKS OR SNACKS COOL
- ATTACHED KEY FOB DISCREETLY HOLDS CONCEAL CARRY POCKET KEYS
- PEBBLE GRAIN PU LEATHER
- DIMENSIONS: 15.25IN L X 5IN W X 12.5IN H

**8231 \ 2 PK \ 026509051619**





# CONCEAL CARRY PURSES



## GWG<sup>®</sup> ADVENTURE CROSS BODY MEDIUM CONCEALED CARRY PURSE

- MEDIUM CROSSBODY CONCEAL CARRY TOTE
- ADJUSTABLE, REMOVABLE, CROSS BODY STRAP AND TOTE STYLE HANDLES
- BACK SLASH POCKET FOR SMALL ITEMS
- LOCKABLE PADDED CONCEAL CARRY POCKET WITH TOP ACCESS
- SIMPLISTIC DESIGN CAN BE WORN FRONT OR BACK TO ACCOMMODATE RIGHT AND LEFT HAND CARRY
- INTERIOR ORGANIZATION IN MAIN COMPARTMENT
- ATTACHED KEY FOB DISCREETLY HOLDS CONCEAL CARRY POCKET KEYS
- BALLISTIC POLYESTER
- DIMENSIONS: 11IN L X 2IN W X 10IN H

BLACK/SILVER

**70635 \ 2 PK \ 026509051503\_**



## GWG<sup>®</sup> TOMBOY CLUTCH SMALL CONCEALED CARRY PURSE

- SMALL CROSSBODY CONCEAL CARRY PURSE
- ADJUSTABLE, REMOVABLE CROSS BODY STRAP
- METAL MAIN ZIPPER WITH LONG ZIPPER PULL
- PADDED AND LOCKABLE CONCEALED CARRY POCKET ON FRONT OF PURSE
- INTERIOR ORGANIZATION IN MAIN COMPARTMENT
- BACK ZIP POCKET
- ATTACHED KEY FOB DISCREETLY HOLDS CONCEAL CARRY POCKET KEYS
- PU LEATHER
- DIMENSIONS: 10IN L X 6.5IN W X 2IN H

CAMO/GOLD

**90-90 \ 3 PK \ 026509053729**



**NEW**

**GIRLS WITH GUNS®  
BLACK LABEL RIFLE SLING**

- LIGHTWEIGHT AND TACKY BACKING
- 1IN HEAVY WEIGHT POLYESTER WEBBING
- SWIVELS TESTED TO 500LBS

BLACKOUT SHADE™ CAMO

8274 \ 4 PK \ 026509062653



**GIRLS WITH GUNS®  
GLENWOOD RIFLE SLING**

- LIGHTWEIGHT CONSTRUCTION
- LOW DENSITY MOLDED FOAM
- NON-SLIP, TEXTURED BACK
- SWIVELS TESTED TO 500LBS

SHADE™ CAMO

8484 \ 6 PK \ 026509008095



**GIRLS WITH GUNS®  
HIGH COUNTRY RIFLE SLING**

- ULTRA DURABLE AND LIGHTWEIGHT
- HEAVY-DUTY WEB CONSTRUCTION
- MOLDED LOW DENSITY FOAM
- NON-SLIP TEXTURED BACKING
- SWIVELS TESTED TO OVER 500LBS

SHADE™ CAMO

8485 \ 6 PK \ 026509008439



**NEW**

**GIRLS WITH GUNS®  
MIDNIGHT RIFLE SLING**

- HEAVY-DUTY NEOPRENE SLING
- RUGGED SPANDEX BINDING LASTS OVER TIME
- SWIVELS TESTED TO 500LBS

BLACKOUT SHADE™ CAMO

8272 \ 4 PK \ 026509062646



**GIRLS WITH GUNS®  
BAKTRAK® VAPOR RIFLE SLING**

- BAKTRAK® RUBBER GRIP PANEL
- SLEEK PROFILE MAXIMIZES COMFORT AND REDUCES WEIGHT
- QUICK ADJUST WITH CAM LOCK BUCKLE
- SWIVELS TESTED TO 500LBS

SHADE™ CAMO

8471 \ 6 PK \ 026509000259









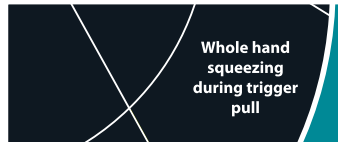
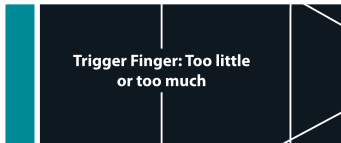
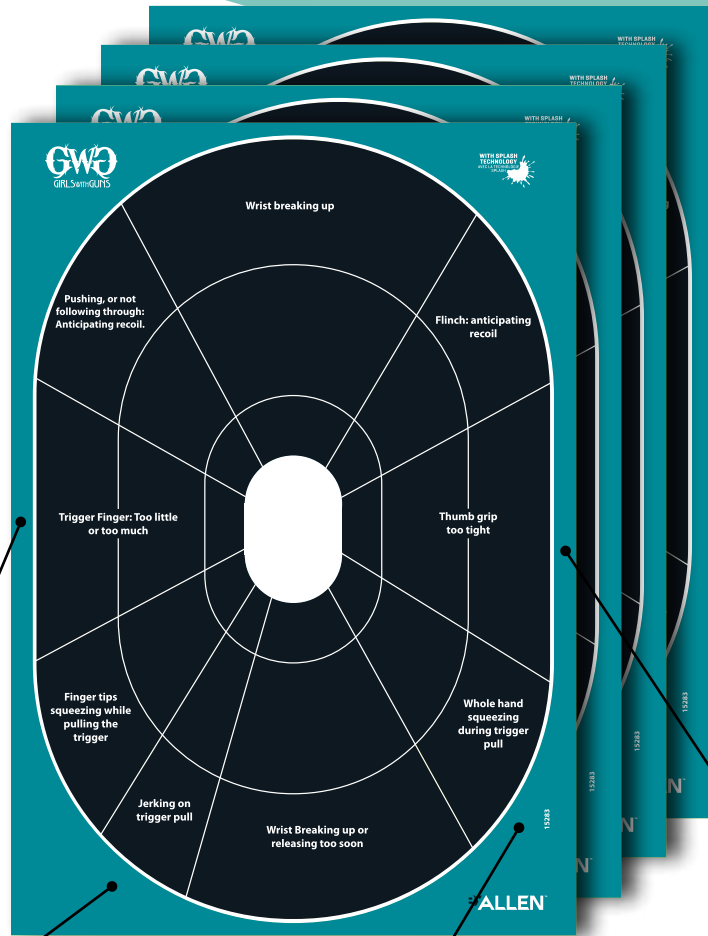

**PRO TIPS PRINTED ON EACH TARGET**

**GIRLS WITH GUNS<sup>®</sup> SPLASH ADHESIVE  
HANDGUN TRAINER 12 x 18, 5 PACK**

- PROVIDES EXCELLENT HANDGUN TRAINING TIPS RIGHT ON THE TARGET TO IMPROVE YOUR SKILLS
- SPLASH TECHNOLOGY HELPS YOU SEE WHERE YOUR SHOTS MAKE IMPACT
- MADE WITH BRIGHT INKS & NEON IMPACT INDICATOR
- ADHESIVE BACK CAN BE APPLIED TO MOST TARGET MATERIALS, SUCH AS CARDBOARD, PLYWOOD, & STEEL
- PAPER DIMENSIONS: 12.5 X 18.25

15283 \ 12 PK \ 026509046813

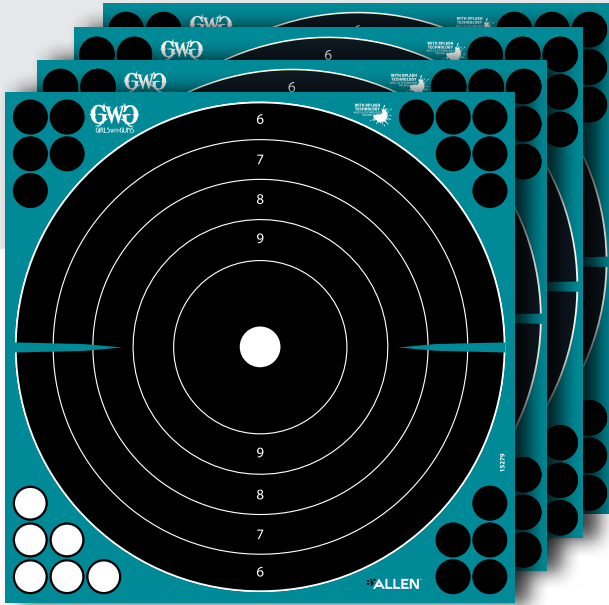

**GIRLS WITH GUNS® SPLASH  
ADHESIVE BULLSEYE  
12 x 12, 5 PACK**

• PAPER DIMENSIONS: 12.5 X 12.5  
15279 | 12 PK | 026509046790

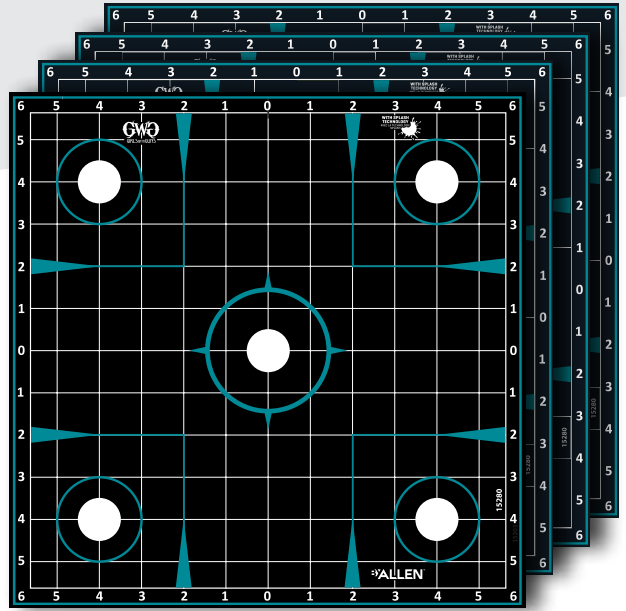

**GIRLS WITH GUNS® SPLASH  
ADHESIVE SIGHT-IN GRID  
12 x 12, 5 PACK**

• PAPER DIMENSIONS: 12.5 X 12.5  
15280 | 12 PK | 026509046806



COMPACT  
DESIGN  
FOR TRAVEL



**GIRLS WITH GUNS® SHIELD  
LOW PROFILE ELECTRONIC MUFF**

- NRR 24 dB
- MEETS ANSI S3.19 AND CE EN352-2
- STEREO MICROPHONE
- AUX INPUT FOR MICROPHONE
- ADJUSTABLE, PADDED HEADBAND
- POWERED BY 2 AAA BATTERIES (NOT INCLUDED)

2348 \ 4 PK \ 026509049784



COMPACT  
DESIGN  
FOR TRAVEL



**GIRLS WITH GUNS® ASSURE  
LOW PROFILE MUFF**

- NRR 23 dB
- MEETS ANSI S3.19 AND CE EN352-2
- FOLDS DOWN FOR EASY TRANSPORTATION
- SOFT PADDED HEADBAND AND EAR CUPS

2319 \ 3 PK \ 026509049722

**GIRLS WITH GUNS® SILENCER™  
FOAM EAR PLUGS**

- NRR 32 dB
  - ANSI S3.19
  - CE EN352-2
  - COMFORTABLE AND EASY TO USE
- 6 PAIRS

2389 \ 6 PK \ 026509051848



CE



**GIRLS WITH GUNS® DEVOTEE  
SHOOTING GLASSES, CLEAR LENS**

- GREAT FOR SHOOTING AND SAFETY
- ANTI-FOG COATING
- UV COATED
- PADDED NOSE AND TEMPLES
- HIGH IMPACT POLYCARBONATE LENS
- ANTI-SCRATCH COATING
- ANSIZ87+ CE RATED

2371 \ 4 PK \ 026509049920



**GIRLS WITH GUNS® AFIRE  
SHOOTING GLASSES, CLEAR LENS**

- GREAT FOR SHOOTING AND SAFETY
- ANTI-FOG COATING
- UV COATED
- ANTI-SCRATCH COATING
- ANSIZ87+ RATED

2370 \ 3 PK \ 026509049913



**GIRLS WITH GUNS®  
ASSURE EYE & EAR COMBO**

**MUFFS:**

- NRR 23 dB
- MEETS ANSI S3.19 AND CE EN352-2
- FOLDS DOWN FOR EASY TRANSPORTATION
- SOFT PADDED HEADBAND AND EAR CUPS

**GLASSES:**

- ANSI Z87-1+
- ANTI-SCRATCH COATING
- PADDED TEMPLES

2388 \ 4 PK \ 026509051831



COMPACT  
DESIGN  
FOR TRAVEL



**GREAT FOR  
SHOOTING  
& SAFETY**



**GWG® MIDNIGHT RANGE BAG**

- 15IN X 8IN X 8IN MAIN COMPARTMENT
- EXTERNAL PADDED ZIP POCKETS WITH GENEROUS STORAGE
- MAGAZINE LOOPS IN FRONT POCKETS
- PISTOL RUG INCLUDED (SIZED TO FIT IN FRONT POCKET)
- ADJUSTABLE, REMOVABLE SHOULDER STRAP

SHADE™ BLACKOUT CAMO

70639 \ 2 PK \ 026509051527



**GIRLS WITH GUNS®  
MIDNIGHT DELUXE PACK**

- NARROW FRAME DESIGN FOR WOMEN
- GENEROUS STORAGE AND ORGANIZATION WITH INTERIOR PADDED LAPTOP/ TABLET SLEEVE
- CONCEALED CARRY POCKET WITH LOCKABLE ZIPPERS, ACCESSIBLE FROM BOTH SIDES
- MESH PADDING ON BACK PANEL AND UNDERSIDE OF BACKPACK STRAPS FOR COMFORT
- DUAL SIDE SPANDEX MESH POCKETS

SHADE™ BLACKOUT CAMO

70637 \ 4 PK \ 026509051510

# BLEND IN & HUNT:

PRODUCTS WITH FEATURES CRITICAL TO REMAINING CONCEALED DURING THE HUNT



AVAILABLE  
IN PDD'S



**NEW**  
**CONCEAL'R  
MESH NETTING**  
12FT x 56IN

- MICRO MESH JERSEY MATERIAL IS QUIET AND GLARE FREE WHILE PROVIDING A VIVID CAMOUFLAGE APPLICATION FOR CONCEALMENT
- DOESN'T FRAY WHEN CUT
- LIGHTWEIGHT, DURABLE MATERIAL STANDS UP TO THE ELEMENTS

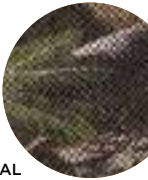

REALTREE EDGE  
25352 \ 6 PK \  
026509065234



MOSSY OAK  
BREAK-UP COUNTRY  
25353 \ 6 PK \  
026509065241

**NEW**  
**TOUGH MESH**  
12FT x 56IN

- WIDE WEAVE, THICK MATERIAL PROVIDES A NATURAL APPEARANCE WHILE PROVIDING DURABILITY TO STAND UP TO THE ELEMENTS
- GLARE-FREE FABRIC
- EASILY ATTACHED TO BOATS, TREESTANDS AND MORE

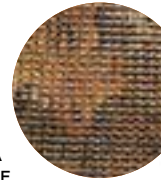

REALTREE EDGE  
25351 \ 6 PK \  
026509065210

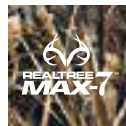

REALTREE MAX-7  
25354 \ 6 PK \  
026509065258

**CAMO TARP**

- TEAR, WEATHER AND CRACK RESISTANT
- HEAVY DUTY ALUMINUM GROMMETS
- 6.5MIL THICKNESS WITH REINFORCED HEMS



SMALL: 6FT x 8FT  
MOSSY OAK  
BREAK-UP COUNTRY  
25331 \ 8 PK \  
026509034438

MEDIUM: 8FT x 10FT  
MOSSY OAK  
BREAK-UP COUNTRY  
25332 \ 5 PK \  
026509034445

LARGE: 9FT x 12FT  
MOSSY OAK  
BREAK-UP COUNTRY  
25333 \ 4 PK \  
026509034452

**CAMO NETTING**  
12FT x 56IN

- ULTRA-LIGHTWEIGHT, PORTABLE AND DURABLE
- FOR GROUND BLINDS, TREESTANDS AND WATERFOWL BLINDS
- GLARE-FREE



REALTREE EDGE  
25322 \ 6 PK \  
026509034360



MOSSY OAK  
BREAK-UP COUNTRY  
25323 \ 6 PK \  
026509034353







**OMNITEX  
3D BLIND FABRIC  
12FT x 56IN**

- DIE-CUT LEAFY PATTERN
- IMITATES NATURAL SURROUNDINGS
- LIGHTWEIGHT, PORTABLE & DURABLE
- GREAT FOR GROUND BLINDS, TREESTANDS & WATERFOWL BLINDS



MOSSY OAK  
BREAK-UP  
COUNTRY  
**25327 \ 6 PK \**  
**026509034049**



REALTREE EDGE  
**25326 \ 6 PK \**  
**026509034087**



MOSSY OAK  
BREAK-UP  
INFINITY  
**25330 \ 6 PK \**  
**026509034063**



MOSSY OAK  
SHADOW GRASS  
BLADES  
**25329 \ 6 PK \**  
**026509034070**

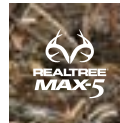

REALTREE MAX-5  
**25328 \ 6 PK \**  
**026509034094**



MOSSY OAK  
WINTER BRUSH  
**25324 \ 6 PK \**  
**026509034056**

**CAMO BURLAP  
12FT x 54IN**

- ULTRA-LIGHTWEIGHT, PORTABLE AND DURABLE
- FOR GROUND BLINDS, TREESTANDS AND WATERFOWL BLINDS
- GLARE-FREE



MOSSY OAK  
BREAK-UP  
COUNTRY  
**25315 \ 6 PK \**  
**026509034162**



REALTREE EDGE  
**25313 \ 6 PK \**  
**026509034216**

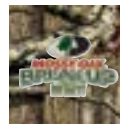

MOSSY OAK  
BREAK-UP  
INFINITY  
**25312 \ 6 PK \**  
**026509034179**



MOSSY OAK  
SHADOW GRASS  
BLADES  
**25317 \ 6 PK \**  
**026509034209**

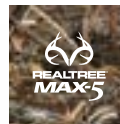

REALTREE MAX-5  
**25334 \ 6 PK \**  
**026509034223**

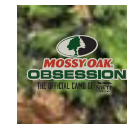

MOSSY OAK  
OBSESSION  
**25311 \ 6 PK \**  
**026509034193**



ALLEN  
GRAIN BELT  
**25335 \ 6 PK \**  
**026509054313**

**BULK BURLAP ROLL  
50YD x 54IN**

- ULTRA-LIGHTWEIGHT, PORTABLE AND DURABLE
- FOR GROUND BLINDS, TREESTANDS AND WATERFOWL BLINDS
- GLARE-FREE

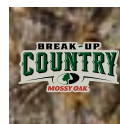

MOSSY OAK  
BREAK-UP  
COUNTRY  
**25318 \ 1 PK \**  
**026509034124**



REALTREE EDGE  
**25319 \ 1 PK \**  
**026509034148**



ALLEN  
GRAIN BELT  
**25338 \ 1 PK \**  
**026509057826**

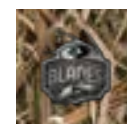

MOSSY OAK  
SHADOW GRASS  
BLADES  
**25320 \ 1 PK \**  
**026509034131**



## MAGNETIC TREESTAND COVER

- 35IN TALL x 8FT WIDE
- MAGNETIC CLOSURE FOR QUIET ENTRY/EXIT
- FITS MOST SINGLE OR DOUBLE LADDER STANDS



REALTREE EDGE  
5314 \ 6 PK \  
026509035824



STORAGE POUCH  
CAN BE USED AS AN  
INTERIOR POCKET

## QUICK SET BLIND

- 50IN TALL x 8FT WIDE
- GREAT FOR SINGLE OR DOUBLE LADDER STANDS
- MAKES EFFECTIVE GROUND BLIND
- GLARE-FREE FABRIC



MOSSY OAK  
BU COUNTRY  
5219 \ 6 PK \  
026509034735



\*TREESTAND  
NOT INCLUDED

## STAKE-OUT BLIND

- 27IN TALL x 10FT WIDE
- 4 COLLAPSIBLE STAKES
- PORTABLE AND QUICK SETUP
- GLARE-FREE



MOSSY OAK  
BU COUNTRY  
5220 \ 6 PK \  
026509034759



## INSTANT ROOF TREESTAND UMBRELLA

- 57IN OVERALL WIDTH
- MOUNTS TO ANY TREE
- STORAGE SACK INCLUDED
- CAMOUFLAGED FOR CONCEALMENT



REALTREE EDGE  
5309 \ 4 PK \  
026509035817



## PROTECTIVE CAMO WRAP

- CONCEALS AND PROTECTS
- RESIDUE FREE, WASHABLE AND REUSABLE
- ONE ROLL COVERS A SHOTGUN, RIFLE, BOW OR CROSSBOW



REALTREE EDGE  
25364 \ 6 PK \  
026509034742



MOSSY OAK  
BU COUNTRY  
25363 \ 6 PK \  
026509034728

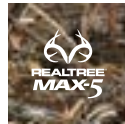

REALTREE MAX-5  
25367 \ 6 PK \  
026509034384



15FT ROLL  
2IN WIDE

## HEAVY-DUTY TREESTAND CARRY STRAPS

- EXTRA PADDING TO CARRY HEAVIER TREESTANDS
- MOUNTS TO MOST TREESTANDS

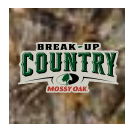

MOSSY OAK  
BU COUNTRY  
5310 \ 6 PK \  
026509035787



## CAMO TAPE

- EASY TO APPLY AND REMOVE
- DURABLE CLOTH MATERIAL
- CONCEALS

10FT ROLL  
2IN WIDE



REALTREE EDGE  
25379 \ 12 PK \  
026509036173



MOSSY OAK  
BU COUNTRY  
25362 \ 12 PK \  
026509034711

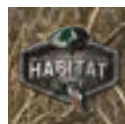

MOSSY OAK  
HABITAT  
25378 \ 12 PK \  
026509036166

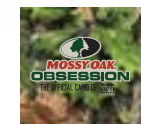

MOSSY OAK  
OBSESSION  
25369 \ 12 PK \  
026509034230

## CAMO DUCT TAPE

- TEAR BY HAND
- GREAT FOR MANY USES

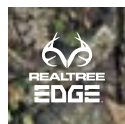

REALTREE EDGE  
25360 \ 12 PK \  
026509034391

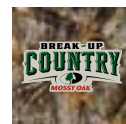

MOSSY OAK  
BREAK-UP COUNTRY  
25361 \ 12 PK \  
026509034339



60FT ROLL  
2IN WIDE

## CAMO FACE PAINT

- 4 CAMO COLORS
- CONCEALS SKIN SURFACE
- WASHES OFF WITH SOAP AND WATER
- NET WEIGHT 0.6oz

BROWN, GREEN, BLACK AND GRAY  
6115 \ 12 PK \ 026509034674



## INSTA FACE PAINT

- 3 CAMO COLORS
- APPLY ALL COLORS AT ONCE
- WASHES OFF WITH SOAP AND WATER
- NET WEIGHT 0.3oz

BROWN, GREEN AND BLACK  
6117 \ 6 PK \ 026509034681





**BALACLAVA FACE MASK**

- GREAT PERIPHERAL VISION
- LIGHTWEIGHT, BREATHABLE
- QUICKLY CONVERTS TO NECK GAITER
- ONE SIZE FITS MOST



REALTREE EDGE  
25345 \ 6 PK \  
026509034117



MOSSY OAK  
BREAK-UP COUNTRY  
25344 \ 6 PK \  
026509034100



**STRETCH FIT MASK**

- LIGHTWEIGHT AND BREATHABLE
- CONTAINS SPANDEX
- ONE SIZE FITS MOST

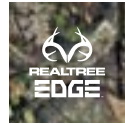

REALTREE EDGE  
25376 \ 6 PK \  
026509034421



MOSSY OAK  
BREAK-UP COUNTRY  
25350 \ 6 PK \  
026509034414



**MESH NECK GAITER**

- GREAT PERIPHERAL VISION
- FOUR-WAY STRETCH FABRIC
- LIGHTWEIGHT, BREATHABLE
- ONE SIZE FITS MOST

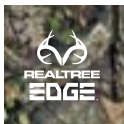

REALTREE EDGE  
25377 \ 6 PK \  
026509034322



MOSSY OAK  
BU COUNTRY  
25349 \ 6 PK \  
026509034315



**TURKEY NECK GAITER**

- CALL POCKET ON FRONT OF GAITER
- ADJUSTABLE PULL CORD ON REAR FOR SECURE FIT
- LIGHTWEIGHT AND BREATHABLE
- ONE SIZE FITS MOST

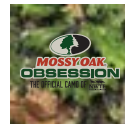

MOSSY OAK  
OBSESSION  
25348 \ 6 PK \  
026509034407



**FULL HEAD NET**

- CONFORMS TO FACE AND GLASSES
- BUILT-IN NOSE BRIDGE
- LIGHTWEIGHT AND DURABLE



REALTREE EDGE  
25375 \ 6 PK \  
026509034513

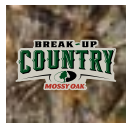

MOSSY OAK  
BU COUNTRY  
25373 \ 6 PK \  
026509034490

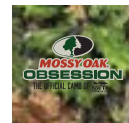

MOSSY OAK  
OBSESSION  
25374 \ 6 PK \  
026509034506



**3/4 HEAD NET**

- CONFORMS TO FACE AND GLASSES
- BUILT-IN NOSE BRIDGE
- LIGHTWEIGHT AND DURABLE



REALTREE EDGE  
25372 \ 6 PK \  
026509034483



MOSSY OAK  
BU COUNTRY  
25370 \ 6 PK \  
026509034469

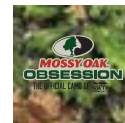

MOSSY OAK  
OBSESSION  
25371 \ 6 PK \  
026509034476



**SPANDEX HUNT GLOVES**

- FOUR-WAY STRETCH FABRIC
- TOUCHSCREEN FINGERTIPS
- SILICONE DOT GRIP PALM
- EXTRA LONG CUFFS KEEP BUGS OUT

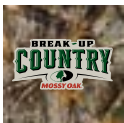

MOSSY OAK  
BREAK-UP COUNTRY  
25341 \ 6 PK \  
026509033318



**TURKEY GLOVES**

- SPUR MEASURE TAPE ON PALM
- HOLDS MOUTH CALLS
- LIGHTWEIGHT, BREATHABLE STRETCH FABRIC

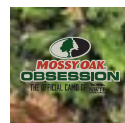

MOSSY OAK  
OBSESSION  
1517 \ 6 PK \  
026509026808



**MESH HUNT GLOVES**

- TOUCHSCREEN FINGERTIPS
- SILICONE DOT GRIP PALM
- LIGHTWEIGHT AND BREATHABLE

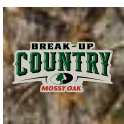

MOSSY OAK  
BREAK-UP COUNTRY  
25342 \ 6 PK \  
026509034292



MOSSY OAK  
BREAK-UP COUNTRY  
25343 \ 6 PK \  
026509034285



**JERSEY HUNT GLOVES**

- TOUCHSCREEN FINGERTIPS
- SILICONE DOT GRIP PALM
- LIGHTWEIGHT AND BREATHABLE



### 360° SWIVEL CHAIR

- SILENT OPERATION
- FOLDS COMPACT FOR STORAGE
- 300LB WEIGHT CAPACITY
- SEAT DIMENSIONS:  
16IN L x 16IN W x 16IN H



NEXT G2 CAMO  
5824 \ 2 PK \  
026509053552

### FOLDING SEAT WITH BACK

- ZIPPERED POCKET BENEATH SEAT
- STRONG POWDER COATED STEEL FRAME
- 225LB WEIGHT CAPACITY
- 14IN L x 16.75IN W x 29IN H

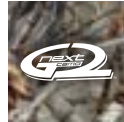

NEXT G2 CAMO  
5854 \ 6 PK \  
026509035411

### THREE LEG FOLDING STOOL

- SHOULDER STRAP
- STRONG STEEL LEGS
- 225LB WEIGHT CAPACITY
- 13IN L x 13IN W x 17IN H

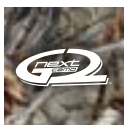

NEXT G2 CAMO  
5857 \ 6 PK \  
026509039761

### FOLDING SEAT

- ZIPPERED POCKET BENEATH SEAT
- STRONG POWDER COATED STEEL FRAME
- 225LB WEIGHT CAPACITY
- 12IN L x 14.5IN W x 17IN H

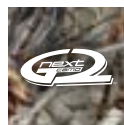

NEXT G2 CAMO  
5853 \ 6 PK \  
026509035428

### SELF-INFLATING SEAT

- RUGGED LOW-PROFILE AIR VALVE
- IDEAL FOR HUNTING, CAMPING, BOATING, OUTDOOR SPORTS AND CONCERTS
- WARM AND COMFORTABLE
- 12IN L x 17IN W

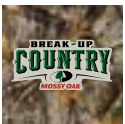

MOSSY OAK  
BREAK-UP COUNTRY  
5851 \ 6 PK \  
026509035510

### THERMO SEAT

- WARM AND COMFORTABLE
- WATER RESISTANT
- RUGGED AND LIGHTWEIGHT
- 14IN DIAMETER X 4.5IN HIGH

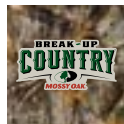

MOSSY OAK  
BREAK-UP COUNTRY  
5848 \ 9 PK \  
026509035497

### DOVE BUCKET

- COMES WITH LID
- 360° PADDED SWIVEL SEAT
- GREAT FOR HUNTING, FISHING AND OUTDOOR RECREATION

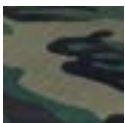

6 NESTED WITH LIDS  
5830 \ 6 PK \  
026509035305

### SWIVEL SEAT BUCKET LID

- 360° PADDED SWIVEL SEAT
- FITS STANDARD 4, 5 AND 6 GALLON BUCKETS
- GREAT FOR HUNTING, FISHING AND OUTDOOR RECREATION
- 12IN DIAMETER x 2IN HIGH

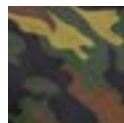

CAMO  
5856 \ 4 PK \  
026509035527



# VANISH™ SEATS, STOOLS & FOAM CUSHIONS



## 1IN FOAM CUSHION

- 1IN THICK PAD FOR ALL-DAY COMFORT
- WATERPROOF LAMINATED TOP LAYER
- 14IN L X 13IN W X 1IN H



REALTREE EDGE  
5835 \ 8 PK \  
026509035367



MOSSY OAK  
BREAK-UP COUNTRY  
5832 \ 8 PK \  
026509035350

## 2IN FOAM CUSHION

- 2IN THICK PAD FOR ALL-DAY COMFORT
- WATERPROOF LAMINATED TOP LAYER
- 14IN L X 13IN W X 2IN H



REALTREE EDGE  
5836 \ 4 PK \  
026509035381

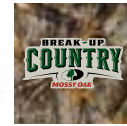

MOSSY OAK  
BU COUNTRY  
5833 \ 4 PK \  
026509035374



OLIVE GREEN  
5839 \ 4 PK \  
026509035343

## MAGNUM FOAM CUSHION

- EXTRA WIDE 2IN PAD FOR ALL-DAY COMFORT
- WATERPROOF LAMINATED TOP LAYER
- STRAPS ATTACH CUSHION TO STAND OR TREE
- WARM AND COMFORTABLE
- 38IN L X 13IN W X 2IN H



REALTREE EDGE  
5842 \ 2 PK \  
026509035329



\*TREESTAND  
NOT INCLUDED



## 2IN XL FOAM CUSHION

- 2IN THICK PAD FOR ALL-DAY COMFORT
- MULTI-PURPOSE ADJUSTABLE WEBBING STRAP
- WATERPROOF LAMINATED TOP LAYER
- 15IN L X 14IN W X 2IN H

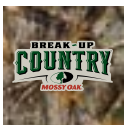

MOSSY OAK  
BREAK-UP COUNTRY  
5834 \ 4 PK \  
026509035404



## FOAM CUSHION WITH BACK

- 2IN THICK SEAT FOR ALL-DAY COMFORT
- WATERPROOF LAMINATED TOP LAYER  
KEEPS MOISTURE AWAY
- ADJUSTABLE WEBBING STRAPS
- BACK: 18IN L X 14IN W X 1IN H
- SEAT: 15IN L X 14IN W  
X 2IN H



REALTREE EDGE  
5841 \ 3 PK \  
026509035398



## MOLDED FOAM SEAT

- 4.5IN EXTRA THICK PAD FOR  
ALL-DAY COMFORT
- WATERPROOF BOTTOM FABRIC
- ADJUSTABLE STRAP TO ATTACH TO  
PACK, BELT LOOP OR TREESTAND
- 15.75IN W X 12.5IN D X 4.5IN H

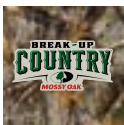

MOSSY OAK  
BREAK-UP COUNTRY  
5859 \ 4 PK \  
026509043454

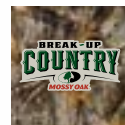

MOSSY OAK  
BREAK-UP COUNTRY  
5858 \ 4 PK \  
026509039778

## MOLDED FOAM SEAT WITH BACK

- MOLDED CUSHION FOR  
ALL-DAY COMFORT
- WATERPROOF BOTTOM FABRIC
- FOLDS FLAT FOR EASY  
STORAGE AND CARRY
- BACK: 12.5IN W X 18IN H
- SEAT: 15.75IN W X 12.5IN D X 1IN H





# BEARDS, STRUTS & SPURS

PURPOSE-BUILT STORAGE FOR TURKEY GEAR



**NEW**

## 2.0 GEAR FIT PURSUIT™ SHOCKER™ TURKEY SHOTGUN CASE: 52IN

- HEAVY-DUTY DUAL-DENSITY FOAM FOR ULTIMATE PROTECTION
- LOCKABLE



MOSSY OAK  
OBSESSION  
961-52 \ 4 PK \  
026509064664

### TURKEY SPECIFIC POCKETS:

- |                       |   |
|-----------------------|---|
| 1. CHOKE TUBE STORAGE | 5. SLATE CALL STORAGE                           |
| 2. MOUTH CALL STORAGE | 6. REMOVABLE TAPE FOR MEASURING SPURS AND BEARD |
| 3. BOX CALL STORAGE   |   |
| 4. STRIKER STORAGE    |   |



## GEAR FIT PURSUIT™ SHOCKER™ TURKEY SHOTGUN CASE: 52IN

- HEAVY-DUTY DUAL-DENSITY FOAM FOR ULTIMATE PROTECTION
- LOCKABLE

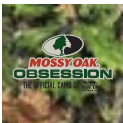

MOSSY OAK  
OBSESSION  
954-52 \ 4 PK \  
026509020417

### TURKEY SPECIFIC POCKETS:

- |                       |   |
|-----------------------|---|
| 1. CHOKE TUBE STORAGE | 5. SLATE CALL STORAGE                           |
| 2. MOUTH CALL STORAGE | 6. REMOVABLE TAPE FOR MEASURING SPURS AND BEARD |
| 3. BOX CALL STORAGE   |   |
| 4. STRIKER STORAGE    |   |







**SHOCKER™ CUT-N-RUN TURKEY PACK**

- CAN BE WORN 3 DIFFERENT WAYS
- TURKEY SPECIFIC POCKETS
- 315 CU IN (5.2 L)

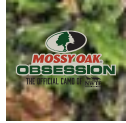

MOSSY OAK  
OBSSESSION  
19170 \ 4 PK \  
026509034254



**TURKEY SPECIFIC FEATURES:**

- |  |  |
|--|--|
| 1. MOUTH CALL STORAGE                    | 5. SLATE CALL POCKET                                     |
| 2. STRIKER SLEEVES                       | 6. BOX CALL STORAGE                                      |
| 3. SHOTGUN SHELL LOOPS                   | 7. MAGNETIC FRONT FLAP FOR QUIET ACCESS TO CARRY FIREARM |
| 4. ZIPPERED REAR POCKET TO CARRY FIREARM |  |

**3-IN-1: WEAR 3 DIFFERENT WAYS**



- |                                 |                                 |                                   |
|---------------------------------|---------------------------------|-----------------------------------|
| 1. THIGH RIG FOR CALLING SETUPS | 2. SLING PACK RUN-N-GUN HUNTING | 3. CHEST PACK COMBINES HUNT TYPES |
|---------------------------------|---------------------------------|-----------------------------------|

**SHOCKER™ TURKEY NECK GAITER**

- MOLDABLE NOSE BRIDGE
- ADJUSTABLE PULL CORD ON REAR FOR SECURE FIT
- LIGHTWEIGHT AND BREATHABLE
- ONE SIZE FITS MOST

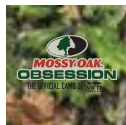

MOSSY OAK  
OBSSESSION  
25348 \ 6 PK \  
026509034407



**TURKEY SPECIFIC FEATURES:**

1. CONVENIENT CALL POCKET ON FRONT OF GAITER

**SHOCKER™ TURKEY GLOVES**

- SILICONE GRIP ON PALM
- EXTENDED CUFF KEEPS BUGS OUT
- LIGHTWEIGHT, BREATHABLE STRETCH FABRIC

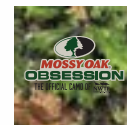

MOSSY OAK  
OBSSESSION  
1517 \ 6 PK \  
026509026808



**TURKEY SPECIFIC FEATURES:**

1. SPUR MEASURE TAPE ON PALM
2. CONVENIENT MOUTH CALL POCKETS

**SHOCKER™ HYPA-LITE™ TURKEY SLING WITH SWIVELS**

- ULTRA DURABLE AND LIGHTWEIGHT
- MOLDED LOW DENSITY FOAM
- NON-SLIP TEXTURED BACKING

**TURKEY SPECIFIC FEATURES:**

1. COVERED MOUTH CALL STORAGE
2. SPARE SHOTGUN SHELL LOOPS
3. SWIVELS TESTED TO OVER 500LBS

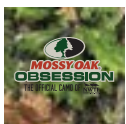

MOSSY OAK  
OBSSESSION  
19170 \ 4 PK \  
026509034254



**SHOCKER™ TOM TAKER CLICK-STIX TURKEY SHOOTING STICK: 36IN**

- FAST AND EASY CRADLE REMOVAL
- PADDED HANDLE GRIP
- DURA-GRIP RUBBER CRADLE



OLIVE WITH CAMO HANDLE  
21927 \ 4 PK \  
026509053927







# MIGRATIONS, BAG LIMITS & WETLANDS



## PURPOSE-BUILT STORAGE FOR WATERFOWL GEAR

### GEAR FIT PURSUIT™ PUNISHER™ WATERFOWL SHOTGUN CASE: 52IN

- HEAVY-DUTY DUAL-DENSITY FOAM FOR ULTIMATE PROTECTION
- LOCKABLE
- EASY CLEAN LINER



REALTREE MAX-5  
961-52 \ 4 PK \  
026509064664

VERSION 2.0  
COMING SOON



**PATENTED**  
US D852,502 S

\*ACCESSORIES SHOWN NOT INCLUDED

#### WATERFOWL SPECIFIC POCKETS:

- |                       |                              |
|-----------------------|------------------------------|
| 1. CALL STORAGE       | 4. CHOKE TUBE STORAGE        |
| 2. LANYARD STORAGE    | 5. DOG TRAINING GEAR STORAGE |
| 3. FIELD GEAR STORAGE | 6. WEATHERPROOF STORAGE      |

### GEAR FIT PURSUIT™ PUNISHER™ WATERFOWL MULTI-FUNCTION PACK

- USE TOP STRAP TO CONVERT TO TIMBER PACK OR USE WAIST STRAP TO CONVERT TO TIMBER PACK
- ADJUSTABLE WAIST BELT AND STERNUM STRAP
- 2944 CU IN (48.2 L)
- 15.25IN L X 9.75IN W X 19.5IN H

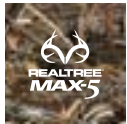

REALTREE MAX-5  
19201 \ 3 PK \  
026509044420



\*ACCESSORIES SHOWN NOT INCLUDED

### HYPA-LITE™ PUNISHER™ WATERFOWL SLING WITH SWIVELS

- ULTRA DURABLE AND LIGHTWEIGHT
- MOLDED LOW DENSITY FOAM
- NON-SLIP TEXTURED BACKING

#### WATERFOWL SPECIFIC FEATURES:

1. SPARE CALL POCKET
2. SPARE SHELL LOOPS
3. D-RINGS TO ATTACH ACCESSORIES
4. SWIVELS TESTED TO OVER 500LBS

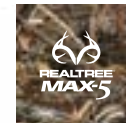

REALTREE MAX-5  
8687 \ 6 PK \  
026509022374

### GEAR FIT PURSUIT™ PUNISHER™ WATERFOWL WAIST PACK

- ORGANIZER POCKETS WITH SHELL LOOPS
- WAIST BELT ADJUSTS TO 52IN
- PADDED MESH BACK FOR COMFORT

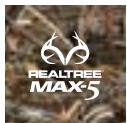

REALTREE MAX-5  
19221 \ 2 PK \  
026509044758

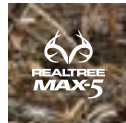

REALTREE MAX-5  
740-52 \ 3 PK \  
026509740520

### WATERPROOF DECOY GLOVES

- 18IN LENGTH
- NEOPRENE DOT GRIP

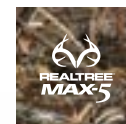

REALTREE MAX-5  
2545 \ 6 PK \  
026509025450

### FLOTATION SLIPCASE: 52IN

- HOOK AND LOOP CLOSURE
- RUGGED ENDURA FABRIC
- ADJUSTABLE SLING
- INTERNAL SIZE: 52IN x 7.5IN



### MESH DECOY BAG

- REINFORCED SHOULDER STRAPS
- HOLDS UP TO 24 STANDARD DUCK DECOYS OR 6 GOOSE DECOYS
- 30IN x 52IN: 11500 CU IN (188 L)



OLIVE MESH WITH BLACK STRAPS  
246 \ 6 PK \  
026509057444



\*ACCESSORIES SHOWN NOT INCLUDED

### SHOTGUN SHELL BELT

- HOLDS 25 SHELLS UP TO 3.5IN LONG
- WAIST ADJUSTABLE TO 58IN
- ADJUSTABLE SIDE RELEASE BUCKLE
- NEOPRENE FABRIC

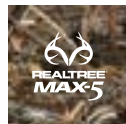

REALTREE MAX-5  
2525 \ 6 PK \  
026509025252



MOSSY OAK SHADOW GRASS BLADES  
2528 \ 6 PK \  
026509025283

\*ACCESSORIES SHOWN NOT INCLUDED

# DROP TINES AND TROPHY MEMORIES

**GEAR FIT PURSUIT™**



PURPOSE-BUILT STORAGE FOR WHITETAIL GEAR

**NEW**  
**2.0 GEAR FIT PURSUIT™ BRUISER™ DEER RIFLE CASE: 48IN**

- HEAVY-DUTY DUAL-DENSITY FOAM FOR ULTIMATE PROTECTION
- FULLY LOCKABLE
- EASY CLEAN LINER

**PATENT PENDING**



\*ACCESSORIES SHOWN NOT INCLUDED



MOSSY OAK COUNTRY DNA  
 965-48 \ 4 PK \  
 026509064671

**DEER SPECIFIC POCKETS:**

1. ORGANIZATION STRAPS
2. LONG POCKET FOR TRIPODS OR SHOOTING STICKS
3. ADJUSTABLE FLAP FOR BULKY ITEMS
4. AMMO BOX STORAGE POCKET
5. SCENT/COVER SPRAY OR WATER STORAGE

**GEAR FIT PURSUIT™ BRUISER™ DEER RIFLE CASE: 48IN**

- HEAVY-DUTY DUAL-DENSITY FOAM FOR ULTIMATE PROTECTION
- LOCKABLE
- EASY CLEAN LINER

**PATENTED**  
 US D852,501 S



\*ACCESSORIES SHOWN NOT INCLUDED



MOSSY OAK BREAK-UP COUNTRY  
 945-48 \ 4 PK \  
 026509020424

**DEER SPECIFIC POCKETS:**

1. FIELD GEAR STORAGE
2. SCENT/COVER SPRAY STORAGE
3. CALLS AND ACCESSORIES STORAGE

**HYPA-LITE™ BRUISER™ DEER SLING WITH SWIVELS**

- ULTRA DURABLE AND LIGHTWEIGHT
- MOLDED LOW DENSITY FOAM
- NON-SLIP TEXTURED BACKING

**DEER SPECIFIC FEATURES:**

1. STRETCH MESH POCKET FOR WINDICATOR BOTTLE OR GRUNT CALL
2. POCKET FOR LENS CLEANING CLOTH
3. D-RINGS TO ATTACH ACCESSORIES
4. SWIVELS TESTED TO OVER 500LBS



**HYPA-LITE™**  
 CALLEN



MOSSY OAK BREAK-UP COUNTRY  
 8688 \ 6 PK \  
 026509022381

**GEAR FIT PURSUIT™ BRUISER™ DEER TREESTAND PACK**

- BOW/RIFLE CARRY SYSTEM
- BUNGEE SYSTEM HOLDS PACK TO A TREESTAND RAIL OR BRANCH
- VELCRO FREE AND SOFT, BRUSHED TRICOT & MICROFIBER MATERIAL FOR A QUIET HUNT
- 18in L X 14.5in W X 8.5in H: 2219 cu in (36.4 L)



MOSSY OAK BREAK-UP COUNTRY  
 19209 \ 2 PK \  
 026509044536



\*ACCESSORIES SHOWN NOT INCLUDED

**GEAR FIT PURSUIT™ BRUISER™ WHITETAIL DAYPACK**

- WORKSTATION ALLOWS ACCESS TO CALLS IN TREESTAND
- REVERSIBLE BLAZE ORANGE RAIN FLY
- GUN/BOW CARRY SYSTEM
- 14in L x 21in H x 8in D: 2532 cu in (35.5 L)

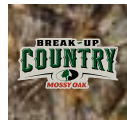

MOSSY OAK BU COUNTRY  
 19175 \ 3 PK \  
 026509027300



\*ACCESSORIES SHOWN NOT INCLUDED

**GEAR FIT PURSUIT™ BRUISER™ DEER GROUND BLIND BAG**

- MOLDED WATER RESISTANT BASE
- DEEP MAIN COMPARTMENT WITH AMPLE STORAGE & INTERNAL ORGANIZER SLEEVES
- POLYESTER FABRIC
- 18in L X 13.5in W X 12in H: 2916 cu in (47.8 L)



MOSSY OAK BREAK-UP COUNTRY  
 19210 \ 3 PK \  
 026509044543



\*ACCESSORIES SHOWN NOT INCLUDED



# CONQUER THE WORLD UNDER YOUR FEET

PACKS AND BAGS DESIGNED FOR EVERY LANDSCAPE



## CRATER MULTI-DAY PACK

- QUIET BRUSHED TRICOT FABRIC (GREAT FOR HUNTERS)
- OVERSIZED POCKET FOR TALL ITEMS: SHOOTING STICK OR BIPOD
- REMOVABLE, PADDED WAIST BELT WITH POCKETS AND HANDGUN HOLSTERS ON BOTH SIDES
- 9.25IN L X 12IN W X 26.25IN H 2914 CU IN (47.7 L)



REALTREE EDGE  
19208 \ 2 PK \  
026509044529



ATS- ADJUSTABLE TORSO SYSTEM



REVERSIBLE RAIN FLY



BOW/RIFLE CARRY SYSTEM

## KNOLL DAYPACK

- QUIET BRUSHED TRICOT FABRIC (GREAT FOR HUNTERS)
- ADJUSTABLE SUSPENSION STRAPS
- REMOVABLE, PADDED WAIST BELT WITH POCKETS AND HANDGUN HOLSTERS ON BOTH SIDES
- 9.25IN L X 12IN W X 21IN H 2331 CU IN (38.2 L)



REALTREE EDGE  
19207 \ 2 PK \  
026509044512



BOW/RIFLE CARRY SYSTEM



## CANYON RUCKSACK

- QUIET RIPSTOP FABRIC (GREAT FOR HUNTERS)
- OVERSIZED, EASY TO PACK OPEN COMPARTMENT WITH DRAWCORD
- INTERIOR ORGANIZER
- 12IN L X 7IN W X 19IN H 1596 CU IN (26.2 L)



MOSSY OAK  
BREAK-UP COUNTRY  
19235 \ 4 PK \  
026509054443



## TWIN MESA DAYPACK

- BOW/RIFLE CARRY SYSTEM
- INTERIOR MESH STORAGE POCKET
- WAIST BELT ADJUSTS UP TO 54IN
- 14IN L X 5IN W X 20IN H 1853 CU IN (30 L)



MOSSY OAK  
BREAK-UP COUNTRY  
18924 \ 3 PK \  
026509059646







**GEAR FIT PURSUIT™  
BRUISER™ DEER  
TREESTAND PACK**

- BOW/RIFLE CARRY SYSTEM
- BUNGEE SYSTEM HOLDS PACK TO TREESTAND OR BRANCH
- SOFT, BRUSHED TRICOT AND MICROFIBER FOR A QUIET HUNT
- 18IN L X 14.5IN W X 8.5IN H: 2219 CU IN (36.4 L)



\*ACCESSORIES SHOWN NOT INCLUDED



MOSSY OAK  
BREAK-UP COUNTRY  
**19209 \ 2 PK \**  
**026509044536**



**GEAR FIT PURSUIT™  
BRUISER™ WHITETAIL  
DAYPACK**

- WORKSTATION ALLOWS ACCESS TO CALLS IN TREESTAND
- REVERSIBLE BLAZE ORANGE RAIN FLY
- GUN/BOW CARRY SYSTEM
- 14IN L X 21IN H X 8IN D: 2532 CU IN (35.5 L)



\*ACCESSORIES SHOWN NOT INCLUDED



MOSSY OAK  
BREAK-UP COUNTRY  
**19175 \ 3 PK \**  
**026509027300**

**RESERVOIR DAYPACK**

- SIDE COMPRESSION STRAPS
- HYDRATION READY
- WAIST BELT ADJUSTS TO 52IN
- 6.25IN L X 10.75IN W X 21IN H 1800 CU IN (29.5 L)



REALTREE EDGE  
**19204 \ 4 PK \**  
**026509044482**

**DUNE DAYPACK**

- OVERSIZED FRONT GRAB HANDLE AND WEBBING LOOPS
- INTERIOR ORGANIZER POCKETS
- POLYESTER FABRIC
- 12.5IN L X 8IN W X 18IN H: 1800 CU IN (29.5 L)



REALTREE EDGE  
**19234 \ 4 PK \**  
**026509054436**

**DELTA DAYPACK**

- INTERIOR ORGANIZER POCKETS
- PADDED, ADJUSTABLE SHOULDER STRAPS
- BRUSHED TRICOT CONSTRUCTION IS SILENT AND DURABLE
- 19IN L X 15IN W X 2.5IN H 1350 CU IN (22.1 L)



MOSSY OAK  
BREAK-UP BLAZE  
**19237 \ 4 PK \**  
**026509054467**

**TUNDRA DAYPACK**

- INTERIOR ORGANIZER POCKETS
- PADDED, ADJUSTABLE SHOULDER STRAPS
- POLYESTER FABRIC
- 19IN L X 15IN W X 2.5IN H 1350 CU IN (22.1 L)



BLAZE ORANGE  
**19238 \ 4 PK \**  
**026509054795**



**CAPE DAYPACK**

- DUAL WATER BOTTLE POCKETS
- ELASTIC CORD HOLDS EXTRA CLOTHING
- INTERIOR ORGANIZER POCKETS
- 7IN L X 11.5IN W X 17IN H 1350 CU IN (22.1 L)

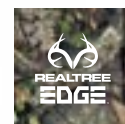

REALTREE EDGE  
**19202 \ 4 PK \**  
**026509044468**



**ALLEN**

**MEAT WAGON GAME CART**

- SOLID ALUMINUM FRAME WILL HOLD UP SEASON AFTER SEASON
- QUICKLY FOLDS FLAT FOR EASY STORAGE AND TRANSPORT
- INCLUDED ADJUSTABLE SHOULDER STRAPS ALLOW FOR MORE PORTABILITY
- TIE-DOWN STRAPS INCLUDED FOR SECURING GAME
- HEAVY-DUTY WHEELS WILL NOT PUNCTURE
- 350LBS WEIGHT CAPACITY



OLIVE  
76890 \ 1 PK \ 026509020899



**ROCK CANYON EXTERNAL PACK FRAME**

- FRAME LENGTH QUICKLY ADJUSTS FROM 33IN TO 36IN FOR INCREASED LOAD CAPACITY
- EXTERIOR LASHING POINTS FOR SECURING HEAVY LOADS
- STURDY ALUMINUM FRAME WITH FOLDING SHELF SUPPORT

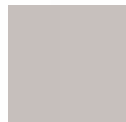

TAN  
1932 \ 2 PK \ 026509020981

**MESA DELUXE BINO PACK**

- EASY OPEN, SILENT MAGNETIC FLAP FOR MAIN BINO COMPARTMENT WITH ADDED CLIP FOR SECURE CLOSE
- ZIPPERED RANGEFINDER POCKET
- BRUSHED TRICOT AND POLYESTER FABRIC
- 9.5IN L X 7.5IN W X 5.5IN H

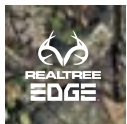

REALTREE EDGE  
19220 \ 2 PK \ 026509044642

**PLATEAU BINO PACK**

- EASY OPEN, SILENT MAGNETIC FLAP FOR MAIN COMPARTMENT WITH ADDED CLIP FOR SECURE CLOSE
- STRAP TO ATTACH RANGEFINDER
- BINO STRAPS FOR SECURE CARRY
- 8.5IN L X 6.75IN W X 3.25IN H

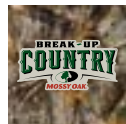

MOSSY OAK BREAK-UP COUNTRY  
19219 \ 2 PK \ 026509044635

**ALLEN**

**ELASTIC BINOCULAR STRAP**

- ELASTIC HARNESS COMFORTABLY HOLDS BINOS AGAINST THE USER'S BODY
- ATTACHES TO MOST BINOS WITH QUICK TIES
- ADJUSTABLE TO FIT ALMOST ANYONE



MOSSY OAK  
198 \ 6 PK \ 026509001980



BLACK  
199 \ 6 PK \ 026509001997



**DELUXE BINOCULAR STRAP**

- ATTACHES TO MOST BINOS WITH QUICK TIES
- LARGER SURFACE AREA FOR ENHANCED WEIGHT DISTRIBUTION
- HOLDS LARGER BINOS MORE EFFICIENTLY
- ADJUSTABLE TO FIT ALMOST ANYONE

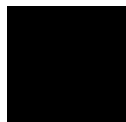

BLACK  
195 \ 4 PK \ 026509001959





# TERRAIN™ BINO PACKS, WAIST PACKS AND DUFFELS



## TUNDRA WAIST PACK WITH HANDWARMER

- DISCREET FRONT POCKET WITH RAIN GUARD
- WAIST BELT ADJUSTS TO 52IN
- BRUSHED TRICOT AND FLEECE
- 12.5IN L X 6.25IN W X 8.5IN H  
300 CU IN (4.9 L)



HAND WARMER COMPARTMENT

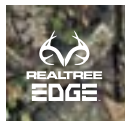

REALTREE EDGE  
19212 \ 2 PK \  
026509044567

## BASIN DUFFEL BAG

- FOLDS UP INTO COMPACT STORAGE BAG GREAT FOR REUSING TO CARRY EXTRA ACCESSORIES
- EXTERIOR COMPRESSION STRAPS
- INTERNAL ORGANIZATION WITHIN MAIN COMPARTMENT
- POLYESTER FABRIC



ASK YOUR SALES REP FOR MORE INFORMATION

192132  
58.5IN T x 20IN W  
x 15IN D



### SMALL

2620 CU IN (42 L)  
21.5IN W X 12.5IN D  
X 9.75IN H  
19213 \ 4 PK \  
026509044574

### MEDIUM

4059 CU IN (66 L)  
26.5IN W X 14.25IN D  
X 10.75IN H  
19214 \ 4 PK \  
026509044581

### LARGE

5506 CU IN (90 L)  
31IN W X 14.5IN D  
X 12.25IN H  
19215 \ 4 PK \  
026509044598

### EXTRA LARGE

11571 CU IN (189 L)  
38IN W X 21IN D  
X 14.5IN H  
19216 \ 4 PK \  
026509044604

## VALE WAIST PACK

- WAIST BELT ADJUSTS TO 52IN
- INTERIOR ZIPPER COMPARTMENT FOR ORGANIZING ACCESSORIES
- POLYESTER FABRIC
- 3IN L X 14.5IN W X 7.75IN H  
600 CU IN (9.8 L)

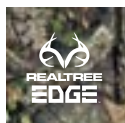

REALTREE EDGE  
19205 \ 4 PK \  
026509044499

## GULCH WAIST PACK 300 CU IN CAPACITY (4.9 L)

- WAIST BELT ADJUSTS TO 52IN
- INTERIOR ORGANIZER POCKETS
- POLYESTER FABRIC
- 3.25IN L X 12.5IN W X 6.5IN H  
300 CU IN (4.9 L)



REALTREE EDGE  
19203 \ 4 PK \  
026509044475



## NORTH PLATTE HERITAGE DUFFEL

- DURABLE 100% COTTON CANVAS EXTERIOR FABRIC
- INTERIOR POCKET ORGANIZATION
- WATERPROOF BOTTOM
- 21.5IN L X 13IN W X 6IN H  
1677 CU IN (27.5 L)



OLIVE  
198100 \ 3 PK \  
026509043485





**NEW**

**BACKCOUNTRY BULL KIT**

- 4 QUARTER BAGS (25IN X 40IN) & 1 MEAT BAG (20IN X 30IN)
- ULTRA-LIGHT, WASHABLE AND REUSABLE
- REFLECTIVE DRAW CORD
- BREATHABLE
- PROTECTIVE SHEET
- GLOVES
- ZIP TIE
- FLAGGING TAPE
- BLAZE ORANGE STORAGE POUCH



6589 \ 6 PK \ 026509063612

**NEW**

**BACKCOUNTRY BUCK KIT**

- 4 QUARTER BAGS (20IN X 30IN) & 1 MEAT BAG (15IN X 20IN)
- ULTRA-LIGHT, WASHABLE AND REUSABLE
- REFLECTIVE DRAW CORD
- BREATHABLE
- PROTECTIVE SHEET
- GLOVES
- ZIP TIE
- FLAGGING TAPE
- BLAZE ORANGE STORAGE POUCH



6599 \ 6 PK \ 026509063865

**NEW**

**BACKCOUNTRY GAME BAG SETS**

- 4 QUARTER BAGS
- ULTRA-LIGHT, WASHABLE AND REUSABLE
- REFLECTIVE DRAW CORD
- BREATHABLE
- BLAZE ORANGE STORAGE POUCH

IMPERIAL ELK:  
25IN X 40IN BAGS  
6590 \ 6 PK \ 026509063629

BRUISER DEER:  
20IN X 30IN BAGS  
6591 \ 6 PK \ 026509063636



**NEW**

**BACKCOUNTRY SINGLE GAME BAGS**

- 1 GAME BAG
- ULTRA-LIGHT, WASHABLE AND REUSABLE
- REFLECTIVE DRAW CORD
- BREATHABLE

1 ELK QUARTER BAG: 25IN X 40IN  
6592 \ 6 PK \ 026509063643

1 MEAT BAG: 20IN X 30IN  
6593 \ 6 PK \ 026509063704

1 CARCASS BAG: 36IN X 72IN  
6594 \ 6 PK \ 026509063728



**NEW**

**COLORADO GAME BAGS DELUXE QUARTER BAGS**

- LIGHTWEIGHT, BREATHABLE MATERIAL WITH EXCELLENT STRETCH
- KEEP YOUR MEAT CLEAN AND PROTECT FROM INSECTS AND DIRT
- MADE IN COLORADO

4 ELK QUARTER BAGS:  
14IN X 35IN  
6595 \ 6 PK \ 026509063742

4 DEER QUARTER BAGS:  
14IN X 28IN  
6596 \ 6 PK \ 026509063759



**NEW**

**COLORADO GAME BAGS CARCASS AND QUARTER BAGS**

- LIGHTWEIGHT, BREATHABLE MATERIAL WITH EXCELLENT STRETCH
- KEEP YOUR MEAT CLEAN AND PROTECT FROM INSECTS AND DIRT
- MADE IN COLORADO

FULL BODY CARCASS BAG: 14IN X 54IN  
6597 \ 6 PK \ 026509063766

4 DEER QUARTER BAGS:  
14IN X 20IN  
6598 \ 6 PK \ 026509063773

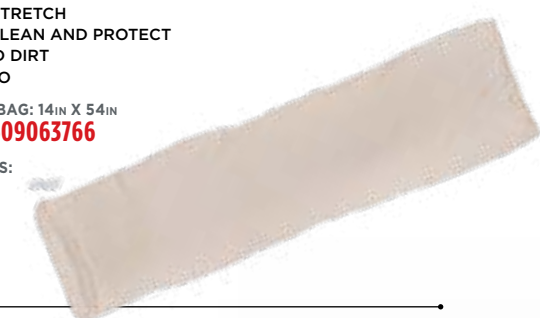

**FIELD DRESSING GLOVES**

- WRIST LENGTH LATEX GLOVES FOR TEDIOUS WORK
- SHOULDER LENGTH GLOVES PROTECT CLOTHING AND MINIMIZE CLEANUP

51 \ 12 PK \ 026509000518



1 PAIR OF EACH

**SPORTSMAN'S SCALE**

- 550LB CAPACITY
- ADJUSTABLE TARE WEIGHT TO ALLOW FOR GAMBRELS
- SHOWS POUNDS AND KILOGRAMS

5500 \ 4 PK \ 026509055006



**SNARE WIRE**

- STAINLESS STEEL OR BRASS
- GREAT FOR MANY USES

BRASS \ 20FT \ 22 GAUGE  
9510 \ 12 PK \ 026509031215

STAINLESS STEEL \ 20FT \ 20 GAUGE  
9511 \ 12 PK \ 026509031208

BRASS \ 20FT \ 20 GAUGE  
9513 \ 12 PK \ 026509031246

STAINLESS STEEL \ 165FT \ 20 GAUGE  
9512 \ 12 PK \ 026509031192



## HUNTING VEST

- ADJUSTABLE HOOK AND LOOP CLOSURE HOLDS VEST SECURE
- COMFORTABLE ELASTIC SIDE BANDS
- FITS CHEST SIZE 38IN TO 48IN (96CM TO 122CM)
- 100% POLYESTER

26IN - 36IN YOUTH  
**15751 \ 6 PK \ 026509157519**  
 38IN - 48IN ADULT  
**15752 \ 6 PK \ 026509157526**  
 60IN BIG MAN  
**15753 \ 6 PK \ 026509157533**



## ALLEN GAME PREP



## HUNTERS ORANGE VEST

- QUIET, 100% POLYESTER MESH
- FRONT TIE CLOSURE
- MACHINE WASHABLE

BLAZE ORANGE  
 ONE SIZE  
**15750 \ 12 PK \ 026509157502**



## HAT AND VEST COMBO

- READY FOR THE HUNT
- CAP HAS ADJUSTABLE BACK (ONE SIZE FITS MOST)
- VEST IS SIZED FOR ADULTS: M-XL

ONE SIZE  
**17555 \ 12 PK \ 026509175551**



ASK YOUR SALES REP FOR MORE INFORMATION



QUARTER PALLET HAT AND VEST DUMP BIN: 99CD  
 42IN T x 20IN W x 24IN D

## DELUXE HUNTING VEST

- BRIGHT BLAZE ORANGE COLOR
- DUAL FRONT POCKETS
- ZIP FRONT CLOSURE
- DURABLE POLYESTER FABRIC

SIZE: M  
 FITS: CHESTS UP TO 44IN (112CM)  
**15765 \ 6 PK \ 026509026761**

SIZE: L  
 FITS: CHESTS UP TO 48IN (122CM)  
**15766 \ 6 PK \ 026509026778**

SIZE: XL  
 FITS: CHESTS UP TO 52IN (132CM)  
**15768 \ 6 PK \ 026509026785**

SIZE: 2XL  
 FITS: CHESTS UP TO 56IN (142CM)  
**15769 \ 6 PK \ 026509026792**



**NEW**

## 6IN REFLECTIVE FLAGGING STRIPS

- 6 STRIPS PER PACKAGE
- HIGHLY REFLECTIVE
- SMALL SLIT TO EASILY LOOP AROUND BRANCHES OR GEAR
- GREAT FOR HUNTING, CAMPING AND OTHER OUTDOOR ACTIVITIES

ORANGE  
**458 \ 8 PK \ 026509063988**



**NEW**

## 10IN REFLECTIVE FLAGGING CORD

- 6 PIECES PER PACKAGE
- HIGHLY REFLECTIVE
- GREAT FOR HUNTING, CAMPING AND OTHER OUTDOOR ACTIVITIES

ORANGE  
**456 \ 8 PK \ 026509063995**



**NEW**

## 50FT REFLECTIVE FLAGGING CORD

- 50 FEET OF CORD
- HIGHLY REFLECTIVE
- GREAT FOR HUNTING, CAMPING AND OTHER OUTDOOR ACTIVITIES

ORANGE  
**470 \ 6 PK \ 026509065050**



## FLAGGING TAPE

- ORANGE FLAGGING TAPE
- 150FT PER ROLL, 0.787IN WIDE

1 ROLL  
**45 \ 12 PK \ 026509000457**



## REFLECTIVE FLAGGING TAPE

- ORANGE FLAGGING TAPE WITH REFLECTIVE STRIPING
- 150FT ROLL, 0.787IN WIDE

**46 \ 12 PK \ 026509000464**



**NEW**

## FLAGGING TAPE

- MARK YOUR LAND WITH PURPLE NO TRESPASSING FLAGGING TAPE
- 150FT ROLL, 0.787IN WIDE

**467 \ 12 PK \ 026509063957**



**NEW**

3 ROLLS  
**459 \ 6 PK \ 026509063971**

12 ROLLS IN PDQ  
**460 \ 12 PK \ 026509063964**



12PK PDQ



12PK PDQ

## REFLECTIVE TRAIL MARKERS

- FOR MARKING ROUTES, BLOOD TRAILS, AND ANY OTHER IMPORTANT PLACE
- GREAT FOR DAY OR NIGHT USE

12 PACK  
**473 \ 6 PK \ 026509004738**



## TRAIL MARKING TACKS

- 50 HIGHLY REFLECTIVE TACKS
- VISIBLE UP TO 20YDS

**47 \ 6 PK \ 026509000471**





**ANTLER MOUNTING KIT**

- SKULL COVER CAN BE FORMED TO MOST HORN CONFIGURATIONS
- STURDY PLAQUE WITH WOOD GRAIN LAMINATED FINISH
- ENGRAVABLE PLATE

GREEN  
**562 \ 4 PK \ 026509005629**  
 RED  
**561 \ 4 PK \ 026509005612**



**HEIRLOOM MOUNTING PLAQUE**

- INCLUDES 2 SKULL COVERS: MOSSY OAK BREAK-UP COUNTRY AND BLACK
- ENGRAVABLE BRASS PLATE INCLUDED
- WORKS FOR WHITETAIL, MULE DEER OR PRONGHORN



MOSSY OAK  
 BREAK-UP COUNTRY  
**569 \ 3 PK \ 026509005698**



**TURKEY TAIL MOUNTING KIT**

- WOOD GRAIN LOOK
- BRASS PLATED COVER

**566 \ 4 PK \ 026509005667**



**DUAL HARNESS DEER DRAG**

- STEEL D-RING
- 2IN WEB CONSTRUCTION
- BLAZE ORANGE STRAPPING
- DRAG ROPE INCLUDED

**33 \ 4 PK \ 026509000334**



**GAMBREL AND HOIST KIT**

- 500LB CAPACITY
- STEEL CONSTRUCTION

**1811 \ 4 PK \ 026509018117**



**TAKEDOWN GAMBREL/HOIST KIT**

- 440LB CAPACITY
- CAST METAL PULLEYS
- STEEL CONSTRUCTION
- COLLAPSIBLE FRAME FOR EASY STORAGE

**181 \ 4 PK \ 026509001812**

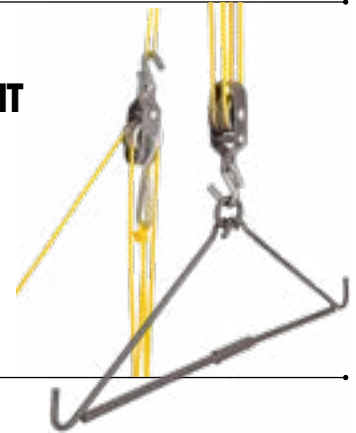

**HEAVY-DUTY GAMBREL**

- 1200LB CAPACITY
- HEAVY-DUTY DESIGN
- 25IN OVERALL LENGTH

**18172 \ 4 PK \ 026509181729**



**GAMBREL FRAME**

- 500LB CAPACITY
- 3/8IN DIAMETER
- 20.5IN OVERALL LENGTH

**18170 \ 6 PK \ 026509181705**

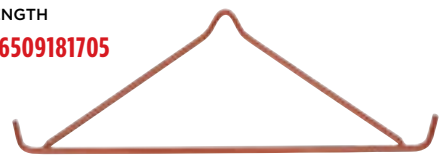

**TREESTAND CARRY STRAPS**

- FILLED WITH WATERPROOF FOAM
- LIGHTWEIGHT AND DURABLE

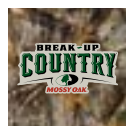

MOSSY OAK  
 BREAK-UP COUNTRY  
**1920 \ 6 PK \ 026509019206**



**HEAVY-DUTY TREESTAND CARRY STRAPS**

- EXTRA PADDING TO CARRY HEAVIER TREESTANDS
- MOUNTS TO MOST TREESTANDS

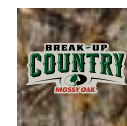

MOSSY OAK  
 BREAK-UP COUNTRY  
**5310 \ 6 PK \ 026509035787**







**HUNTSMAN FOLDING SAW**

- 11in BLADES
- WOOD CUTTING BLADE
- BONE/METAL CUTTING BLADE
- POLYESTER SHEATH

18920 \ 3 PK \ 026509051480



**HIGH MESA TAKEDOWN SAW**

- TAKE-DOWN DESIGN
- STORES IN A RUGGED ENDURA CASE
- WOOD AND BONE (OR METAL) BLADES INCLUDED

187 \ 6 PK \ 026509001874



**LENSATIC COMPASS**

- HIGH IMPACT, LIGHTWEIGHT OUTER BODY
- LUMINOUS DIAL
- FOB ATTACHMENT FOR LANYARD

486 \ 6 PK \ 026509004868



**LIQUID FILLED COMPASS ON PIN**

- BALL SHAPED COMPASS WORKS AT ANY ANGLE
- SAFETY PIN TYPE ATTACHMENT
- LUMINOUS DIAL

484 \ 6 PK \ 026509004844



**POCKET COMPASS**

- HIGH IMPACT, LIGHTWEIGHT BODY
- LUMINOUS DIAL
- RING ATTACHMENT FOR LANYARD

487 \ 6 PK \ 026509004875



**TREESTAND GEAR HANGER**

- EASY-STARTING SCREW

1 PK 501 \ 50 PK \ 026509005018

3 PK 5013 \ 6 PK \ 026509050131



**GAME CAMERA TREE MOUNT**

- 3 MOUNTS QUICKLY AND EASILY MOUNT GAME CAMERAS
- ALL-STEEL CONSTRUCTION
- WEATHER-RESISTANT FINISH
- EASY-START TIP AIDS IN INSTALLATION
- 1/4in-20 THREADS FIT MOST GAME CAMERAS

5307 \ 6 PK \ 026509033806



**REFLECTIVE TREESTAND GUN AND BOW ROPE, 25FT**

- 25FT OF REFLECTIVE ROPE
- LOCKDOWN JAWS KEEP ROPE KNOT FREE
- LOCATE TREESTAND EASILY IN THE DARK

56 \ 6 PK \ 026509000563



**DELUXE AUTOMATIC GUN AND BOW RETRIEVER, 25FT**

- MANAGES THE CORD USED FOR HOISTING A GUN OR BOW INTO A TREESTAND
- CORD CAN BE LOCKED IN AN EXTENDED POSITION
- SNAP HOOK

5265 \ 6 PK \ 026509052654



**BOW AND GUN ROPE WITH TWO GEAR HANGERS**

- 20FT CAMO CORD
- 2 SOFT EXPANDED VINYL COATED STEEL BOW HANGERS

54 \ 6 PK \ 026509000549



**TREESTAND BOW AND GUN ROPE, 30FT**

- 30FT LENGTH
- CARABINER CLIPS

53 \ 6 PK \ 026509000532



# PROTECTED BY A TITAN:

PRODUCTS FORMED WITH BETTER, ENHANCED MATERIALS TO ACHIEVE GREATER PERFORMANCE



## COPPERHEAD CROSSBOW CASE

- FITS: **NARROW LIMB CROSSBOWS**
- FIVE EXTERNAL POCKETS FOR STORAGE
- QUIVER POCKET FOR SAFE STORAGE
- ADJUSTABLE INTERNAL QUIVER POCKET AND DIVIDER FOR OPTIMAL PROTECTION
- SOFT BRUSHED TRICOT LINING
- 16IN W X 38IN L X 12IN H

OLIVE  
6047 \ 3 PK \ 026509044352

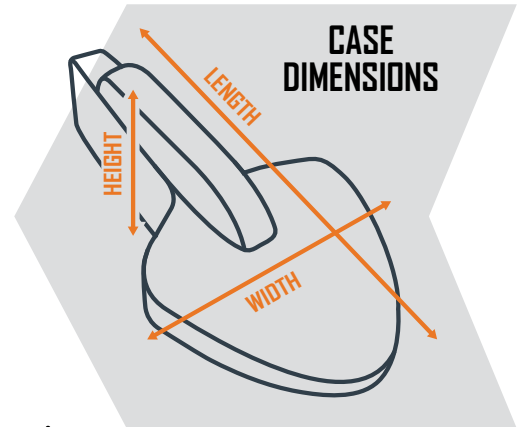

## KRAIT CROSSBOW CASE

- FITS: **NARROW LIMB CROSSBOWS**
- INTERNAL WEBBING STRAP
- TWO OVERSIZED ZIPPERED POCKETS FOR BOLTS, QUIVERS OR OTHER ACCESSORIES
- 19.5IN W X 37IN L X 10.75IN H

GRAY/RED  
6081 / 2PK / 026509054481



PADDED BACKPACK STRAPS



## COBRA CROSSBOW CASE

- FITS: **SOME RECURVE LIMB CROSSBOWS**
- CARRY HANDLE
- SHOULDER STRAP
- 22IN W X 37IN L X 8IN H

BLACK  
6079 \ 2 PK \ 026509054474



## RECLUSE CROSSBOW CASE

- FITS: **RECURVE LIMB AND STANDARD LIMB CROSSBOWS**
- DOUBLE ZIPPER FOR EASIER OPENING
- SOFT BRUSHED TRICOT LINING
- 24.5IN W X 38IN L X 11.5IN H

MOSSY OAK BREAK-UP COUNTRY  
6073 / 4PK / 026509033554



## WASP CROSSBOW CASE

- FITS: **RECURVE LIMB AND STANDARD LIMB CROSSBOWS**
- DOUBLE ZIPPER FOR EASIER OPENING
- SOFT BRUSHED TRICOT LINING
- 24IN W X 37.5IN L X 8.5IN H

BLACK  
6075 / 4PK / 026509049098



**SLIDEGUIDE™ CROSSBOW COCKING SLED**

- FITS MOST CROSSBOW RAILS
- CUSHION COMFORT GRIP
- RATED FOR BOWS UP TO 185.LBS

GRAY/ORANGE  
7568 / 6PK / 026509026617

FREE-GLIDE SPRINGS SLIDE ALONG RAIL



**CROSSBOW COCKING ROPE**

- FOR USE WITH MOST CROSSBOW MODELS
- REDUCES DRAW WEIGHT UP TO 50%
- OVERSIZED HANDLES FOR BETTER GRIP
- RATED FOR BOWS UP TO 185LBS

BLACK/ORANGE  
756 / 6PK / 026509011484



**CROSSBOW STRING WAX & RAIL LUBE**

- |                         |  |
|-------------------------|--|
| <b>STRING WAX:</b>      | <b>RAIL LUBE:</b>                      |
| • REDUCES NOISE         | • INCREASES ARROW SPEED                |
| • INCREASES STRING LIFE | • REDUCES STRING WEAR & LENGTHENS LIFE |

STRING WAX & RAIL LUBE COMBO  
673 / 6PK / 026509034803

CROSSBOW RAIL LUBE  
676 / 6PK / 026509006763

USA  
★★★



**LASER BORESIGHTER**

- MAKES SIGHT-IN EASY
- PRECISION BODY FOR PERFECT RAIL ALIGNMENT
- POSITIVE ON/OFF SWITCH
- 3 LR754 BATTERIES INCLUDED

BLACK/GRAY  
60111 / 6PK / 026509034773



**NEOPRENE CROSSBOW SLING**

- SWIVELS TESTED TO 500LBS
- LIGHTWEIGHT CUSHIONED SHOULDER STRAP
- NON-SLIP BACK

REALTREE EDGE  
6014 / 6PK / 026509060147



**CROSSBOW DECOCKING BOLT**

- FOR USE WITH MOST CROSSBOWS
- 465 GRAINS
- STEEL TIP

24IN FIBERGLASS SHAFT  
93340 / 6PK / 026509011088

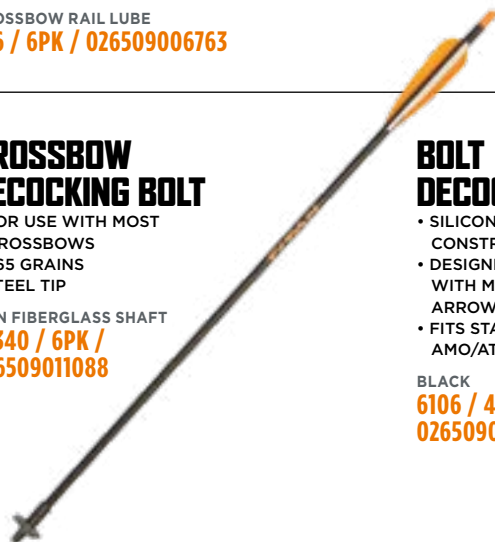

**BOLT DECOCKING HEAD**

- SILICONE AND STEEL CONSTRUCTION
- DESIGNED FOR USE WITH MOST CROSSBOW ARROWS/BOLTS
- FITS STANDARD AMO/ATA THREADS

BLACK  
6106 / 4PK / 026509052678

\*BOLT NOT INCLUDED



**CROSSBOW DECOCKING BOLTS**

- SAFELY DISCHARGE CROSSBOW
- RUGGED STEEL TIP
- RUGGED, SOLID POLYMER DESIGN

5 SINGLE USE POCKET SIZE BOLTS  
93345 / 6PK / 026509034766

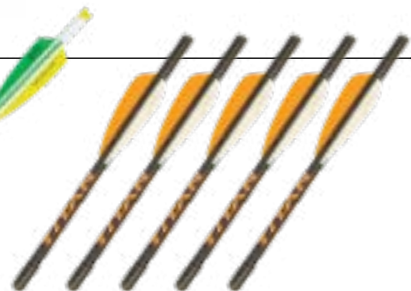





**NEW**

**LARKSPUR BOW CASE**

- FITS COMPOUND BOWS UP TO 40IN
- INTERNAL WEBBING STRAPS TO SECURE BOW
- LARGE QUIVER POCKET FOR ARROW TUBES OR QUIVERS
- PADDED ADJUSTABLE SHOULDER STRAP
- DURABLE RIPSTOP EXTERIOR
- 42IN L X 18.5IN H X 6IN D

BLACK  
6082 / 1PK / 026509062875



**NEW**

**BLOODROOT BOW CASE**

- FITS COMPOUND BOWS UP TO 40IN
- INTERNAL WEBBING STRAPS TO SECURE BOW
- LARGE QUIVER POCKET FOR ARROW TUBES OR QUIVERS
- PADDED ADJUSTABLE SHOULDER STRAP
- DURABLE RIPSTOP EXTERIOR
- 42IN L X 18.5IN H X 6IN D

REALTREE EDGE  
6083 / 1PK / 026509062882



**HEMLOCK BOW CASE**

- INTERNAL MOVABLE BOW STRAPS
- LARGE QUIVER POCKET
- LARGE BRUSHED TRICOT LINED INTERNAL CAVITY
- SOFT PADDED SHOULDER STRAP
- 41IN L X 18IN H X 3IN D

MO BREAK-UP COUNTRY  
6068 / 4PK / 026509033509



**ACONITE BOW CASE**

- LARGE BRUSHED TRICOT LINED INTERNAL CAVITY AND WEBBING STRAPS TO SECURE BOW
- LARGE QUIVER POCKET FOR OPTIMAL STORAGE
- SOFT, PADDED SHOULDER STRAPS
- 41IN L X 18.5IN H X 3IN D

GREEN/BLACK  
6072 / 4PK / 026509033547



**NEW**

**BUCKTHORN BOW CASE**

- FITS COMPOUND BOWS UP TO 37IN
- LARGE QUIVER POCKET
- 38IN L X 18.5IN H X 4IN D

MO COUNTRY DNA  
6093 / 3PK / 026509062936



**NEW**

**SPINDLE BOW CASE**

- FITS COMPOUND BOWS UP TO 37IN
- LARGE QUIVER POCKET
- DURABLE RIPSTOP EXTERIOR
- 38IN L X 18.5IN H X 4IN D

BLACK/GRAY  
6089 / 3PK / 026509062943

# BOW CASES, SLING & QUIVERS

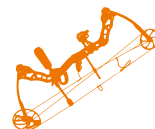

**NEW**

## BRACKEN BOW CASE

- FITS COMPOUND BOWS UP TO 37IN
- REINFORCED CARRY HANDLES
- 38IN L X 18.5IN H X 11IN D

BLACK  
6086 / 4PK / 026509062912

**NEW**

## SUMAC BOW CASE

- FITS COMPOUND BOWS UP TO 37IN
- LARGE QUIVER POCKET
- REINFORCED CARRY HANDLES
- 38IN L X 18.5IN H X 11IN D

REALTREE EDGE  
6087 / 4PK / 026509062929



## QUICK FIT BOW SLING

- FITS BOWS UP TO 40IN
- PADDED ENDS PROTECT CAMS
- WATERPROOF FABRIC
- STORES COMPACT USING BUILT-IN ELASTIC BAND

REALTREE EDGE  
25010 / 3PK / 026509250104



**NEW**

## SEQUENCE YOUTH BOW CASE

- DESIGNED TO FIT GENESIS BOWS AND OTHER BOWS UP TO 40IN
- ADJUSTABLE, REINFORCED CARRY HANDLES
- 41IN L X 14IN H X 11IN D

BLACK/RED  
6084 / 4PK / 026509062899



**NEW**

## QUARRY YOUTH BOW CASE

- DESIGNED TO FIT GENESIS BOWS AND OTHER BOWS UP TO 40IN
- ADJUSTABLE, REINFORCED CARRY HANDLES
- 41IN L X 14IN H X 11IN D

MO COUNTRY DNA  
6092 / 4PK / 026509062905



**NEW**

## SHIELD 4 ARROW QUIVER

- FITS VERTICAL BOWS AND CROSSBOWS
- HOLDS 4 ARROWS: CROSSBOW ARROWS, HUNTING ARROWS OR YOUTH ARROWS
- QUICK DETACH MOUNTING BRACKET
- FOAM LINED HOOD

BLACK  
7015 / 3PK / 026509050315



## COMPACT BACK QUIVER

- 19IN LENGTH
- HOLDS UP TO 14 ARROWS

BLACK/ORANGE  
7036 / 3PK / 026509070368

BLACK/PURPLE  
7038 / 3PK / 026509070382



## SIDEKICK QUIVER PACK

- 19.5IN LENGTH
- HOLDS VARIOUS SIZED ARROWS
- RUGGED ENDURA SHELL

3 BLACK & 3 MOSSY OAK BREAK-UP INFINITY  
7000 / 6PK / 026509070009



## COMPACT HIP QUIVER

- 17.5IN LENGTH
- HOLDS UP TO 16 ARROWS
- MOLDED TWO-CAVITY DIVIDER
- BELT CLIP INCLUDED

GRAY  
7005 / 6PK / 026509002345



6 BULLET POINTS PER PACK

## STAY TIGHT BULLET POINTS

- 100 GRAIN / 9/32IN  
**1483 / 6 PK / 026509014836**
- 100 GRAIN / 5/16IN  
**1478 / 6 PK / 026509014782**
- 125 GRAIN / 9/32IN  
**1485 / 6 PK / 026509014850**
- 100 GRAIN / 11/32IN  
**1472 / 6 PK / 026509014720**

**100GR**

**125GR**

**17/64**  
0.266 / 6MM-7MM

**9/32**  
0.281 / 7MM-8MM

**5/16**  
0.313 / 7MM-8MM

**21/64**  
0.328 / 8MM-9MM

**11/32**  
0.344 / 8MM-9MM

**1483**

**1485**

**1478**

**1472**



12 PER PACK



## BULLET POINTS

- 100 GRAIN / 17/64IN  
**1439 / 6 PK / 026509014393**
- 100 GRAIN / 9/32IN  
**1464 / 6 PK / 026509014645**
- 100 GRAIN / 5/16IN  
**1460 / 6 PK / 026509014607**
- 100 GRAIN / 21/64IN  
**1435 / 6 PK / 026509014355**
- 100 GRAIN / 11/32IN  
**1461 / 6 PK / 026509014614**
- 85 GRAIN / 9/32IN  
**1468 / 6 PK / 026509014683**
- 125 GRAIN / 9/32IN  
**1470 / 6 PK / 026509016878**
- 125 GRAIN / 5/16IN  
**1462 / 6 PK / 026509014621**
- 125 GRAIN / 11/32IN  
**1463 / 6 PK / 026509014638**

**85GR**

**100GR**

**125GR**

**1439**

**1468**

**1464**

**1470**

**1460**

**1462**

**1435**

**1461**

**1463**



## NINJA SMALL GAME POINT

- REDUCES ARROW LOSS

100GR METAL  
**147 / 6 PK / 026509001478**

## THRASHER SMALL GAME POINT

- DESIGNED TO DELIVER MAXIMUM SHOCK & INTERNAL DAMAGE
- ONE PIECE SOLID STEEL FERRULE
- WINGS PREVENT POINT FROM BURYING IN GROUND

100GR BLACK  
**1424 / 6 PK / 026509021186**



## BROADHEAD CADDY

- FITS UP TO 6 BROADHEADS
- FITS MOST FIXED AND MECHANICAL BROADHEADS
- FOAM LINED
- SECURE CAM STYLE CLOSURE

BLACK  
**7009 / 4PK / 026509050254**



## CARDBOARD DEER TARGET

- OUTLINED VITALS
- USE WITH BALE TARGETS
- 42.25IN W X 21.5IN H

CORRUGATE  
**2005 / 12PK / 026509001461**

## BOWSTRING WAX **USA** ★★★

- MADE IN THE USA
- IDEAL FOR SYNTHETIC BOWSTRINGS
- LENGTHENS STRING LIFE

BOWSTRING WAX  
**674 / 6PK / 026509006749**



## CARBON ARROW NOCKS & INSERTS

- FITS 9/32IN DIAMETER

12 GREEN NOCKS  
**68400 / 6PK / 026509684008**

6 GREEN NOCKS & 6 INSERTS  
**68425 / 6PK / 026509684251**

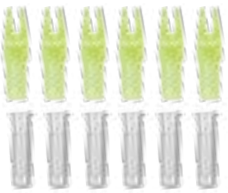

## AUTOMATIC PEEP SIGHT

- LARGE HOLE FOR MORE LIGHT
- GREAT SIGHTING AID FOR MAX ACCURACY

AUTOMATIC PEEP SIGHT  
**6663 / 6PK / 026509066637**

1FT REPLACEMENT TUBING  
**6664 / 6PK / 026509066644**



## STRING LOOPS

- IMPROVES ACCURACY BY REDUCING STRING TORQUE
- ELIMINATES STRING WEAR

3 PER PACK  
**545 / 6PK / 026509005452**

## BRASS NOCK SET **USA** ★★★

- MADE IN THE USA
- CRIMP ON

5 PER PACK  
**540 / 6PK / 026509005407**

## KISSER BUTTON **USA** ★★★

- MADE IN THE USA
- ENSURES THE SAME ANCHOR POINT

BLACK  
**161 / 6PK / 026509001614**







**NEW REAR DEPLOYING BROADHEAD WITH SLIDE AND SLICE™ DESIGN FOR LARGER BLOOD TRAILS**

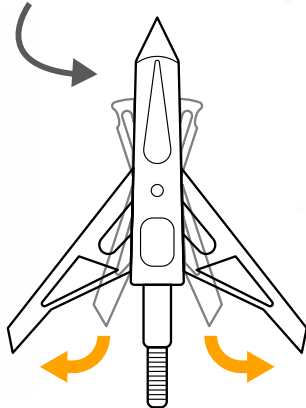

**NEW**  
**VAPOR**  
**REAR DEPLOYING**  
**2 BLADE BROADHEAD**

- .032IN STAINLESS STEEL BLADES
- FLIES LIKE A FIELD TIP
- SLIDE AND SLICE™ DESIGN

100 GRAIN / 2IN CUT  
**14786 / 6PK / 026509059776**



**TOMAHAWK**  
**EXPANDABLE BROADHEAD**

- .032IN STAINLESS STEEL BLADES
- AIRCRAFT ALUMINUM FERRULE
- RAZOR SHARP CHISEL TIP

100 GRAIN / 1.75IN CUT  
**14674 / 6PK / 026509045540**



**THERM-X**  
**EXPANDABLE BROADHEAD**

- .032IN STAINLESS STEEL BLADES
- AIRCRAFT ALUMINUM FERRULE
- RAZOR SHARP PIERCING TIP

100 GRAIN / 2IN CUT  
**14676 / 6PK / 026509045557**



**IMPACT**  
**FIXED BROADHEAD**

- .027IN STAINLESS STEEL BLADES
- AIRCRAFT ALUMINUM FERRULE
- CHISEL POINT DESIGN

100 GRAIN / 1IN CUT  
**14635 / 6PK / 026509146353**



**ION**  
**FIXED BROADHEAD**

- RAZOR SHARP BLADES
- MOLTEN METAL TECHNOLOGY

100 GRAIN / 1IN CUT  
**14615 / 6PK / 026509146155**



**BROADHEADS WITH A HARDENED STEEL INTEGRAL LOCKING SYSTEM**



**STEEL ION**  
**3 BLADE BROADHEAD**

- .032IN STAINLESS STEEL BLADES
- CARBON STEEL LOCKING SYSTEM

100 GRAIN / 1.25IN CUT  
**14679 / 6PK / 026509945564**

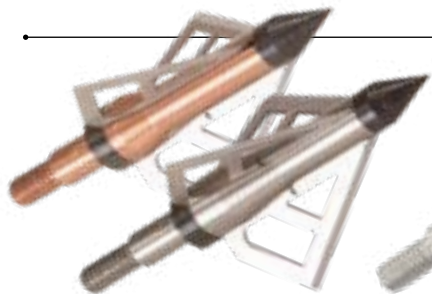

**OPTIMUS**  
**3 BLADE BROADHEAD**

- .032IN STAINLESS STEEL BLADES
- AIRCRAFT ALUMINUM FERRULE

100 GRAIN / 1.0625IN CUT / ROSE  
**14611 / 6PK / 026509146117**

125 GRAIN / 1.1875IN CUT / SILVER  
**14625 / 6PK / 026509146254**



**BALLISTIC SS**  
**3 BLADE BROADHEAD**

- .032IN STAINLESS STEEL BLADES
- STAINLESS STEEL FERRULE
- HARDENED CARBON STEEL TIP

100 GRAIN / 1.125IN CUT  
**14690 / 6PK / 026509033714**

100 GRAIN / 1.125IN CUT / CROSSBOW  
**14691 / 6PK / 026509033721**

125 GRAIN / 1.375IN CUT / CROSSBOW  
**14672 / 6PK / 026509045533**



**TERMINUS**  
**3 BLADE BROADHEAD**

- .032IN STAINLESS STEEL BLADES
- AIRCRAFT ALUMINUM FERRULE
- HARDENED CARBON STEEL TIP

100 GRAIN / 1.375IN CUT  
**14693 / 6PK / 026509033691**

100 GRAIN / 1.375IN CUT / CROSSBOW  
**14694 / 6PK / 026509033684**

125 GRAIN / 1.375IN CUT / CROSSBOW  
**14695 / 6PK / 026509033707**



**PHOTON**  
**3 BLADE BROADHEAD**

- .032IN STAINLESS STEEL BLADES
- AIRCRAFT ALUMINUM FERRULE
- HARDENED CARBON STEEL TIP

100 GRAIN / 1.125IN CUT  
**14696 / 6PK / 026509033745**

125 GRAIN / 1.375IN CUT  
**14697 / 6PK / 026509033752**

**BOLTS**



**XD300  
CROSSBOW BOLT**

- .006 STRAIGHTNESS
  - 12.35 GRAINS PER INCH
  - 3.5IN BOHNING\* X-VANES
- 20IN / 3 PACK WRAP / NEON GREEN/WHITE  
**93230 / 4PK / 026509045519**

**CX600  
CROSSBOW BOLT**

- .006 STRAIGHTNESS
  - 12.35 GRAINS PER INCH
  - 3IN VANES
- 20IN / 3 PACK WRAP / NEON GREEN/WHITE  
**93120 / 4PK / 026509045427**
- 22IN / 3 PACK WRAP / NEON GREEN/YELLOW  
**93122 / 4PK / 026509045434**
- 20IN / 24 COUNT DISPLAY / NEON GREEN/WHITE  
**93221 / 1PK / 026509045441**
- 22IN / 24 COUNT DISPLAY / NEON GREEN/YELLOW  
**93222 / 1PK / 026509045465**

**YOUTH**



**BLADE100  
YOUTH ARROW**

- 3IN VANES
  - FOR BOWS UP TO 35LB
  - DURABLE FIBERGLASS SHAFT
  - PRECISION TARGET POINT
- 26IN / 3 PACK CARD / NEON GREEN/WHITE  
**93226 / 4PK / 026509026679**
- 28IN / 3 PACK CARD / NEON GREEN/YELLOW  
**93228 / 4PK / 026509026662**
- 28IN / 36 COUNT DISPLAY / NEON GREEN/YELLOW  
**9228-PDQ / 1PK / 026509015352**

**ARROWS**



**RZ350  
CARBON ARROW**

- .006 STRAIGHTNESS
  - 10.2 GRAINS PER INCH
  - 2IN BOHNING\* BLAZER VANES
- 29IN / 3 PACK WRAP / KIWI/WHITE  
**9120 / 4PK / 026509045571**
- 30IN / 3 PACK WRAP / KIWI/NEON YELLOW  
**9121 / 4PK / 026509045588**
- 31IN / 3 PACK WRAP / KIWI/SATIN BLUE  
**9122 / 4PK / 026509045595**

**RZ600  
CARBON ARROW**

- .006 STRAIGHTNESS
  - 10.2 GRAINS PER INCH
  - 2IN VANES
- 29IN / 36 COUNT DISPLAY / KIWI/WHITE  
**9140 / 1PK / 026509045663**
- 31IN / 36 COUNT DISPLAY / NEON GREEN/BLUE  
**9142 / 1PK / 026509045687**



**DISPLAYS  
AVAILABLE FOR  
RZ600, CX600 & BLADE100**



### ERGONOMICS OF ARCHERY TOOLS WITH MAXIMUM ENERGY POTENTIAL



#### MV<sup>2</sup> BROADHEAD WRENCH SHARPENER

- CARBIDE BROADHEAD SHARPENER
- BROADHEAD COLLAR WRENCH
- WRENCH FITS BOTH FIXED AND EXPANDABLE BROADHEADS
- NOCK TUNING SLOTS

GREEN/GREY  
14710 / 6 PK / 026509045915



#### CONVERGENCE BROADHEAD WRENCH SHARPENER

- CARBIDE BROADHEAD SHARPENER
- BROADHEAD COLLAR WRENCH
- WRENCH FITS BOTH FIXED AND EXPANDABLE BROADHEADS
- NOCK TUNING SLOTS

GREEN/GREY  
14712 / 6 PK / 026509045984



#### COMPANT BOW TUNING KIT

- THREE NOCKING POINTS
- BOW SQUARE ALIGNS ARROW RESTS & NOCKING POINT
- PLIERS REMOVE & TIGHTEN NOCKS

GREEN/GREY  
158 / 6 PK / 026509001584

**NEW**

#### LUMEN BOW TUNING KIT

- INCLUDES LUMEN BOW SQUARE, NOCK PLIERS AND 3 NOCK SETS
- FITS STANDARD CARBON AND SMALL DIAMETER ARROW SHAFTS

GREY  
6091 / 4 PK / 026509060963

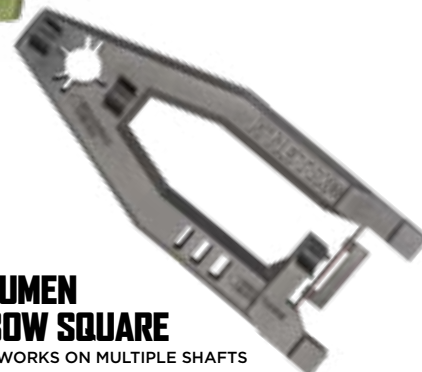

#### LUMEN BOW SQUARE

- WORKS ON MULTIPLE SHAFTS
- BUILT-IN BROADHEAD WRENCH
- NOCK TUNING SLOTS
- KISSER BUTTON GAUGE

BLACK  
6090 / 4 PK / 026509057505



#### VELOVISE NOCKING PLIERS

- TIGHTENS NOCKS
- REMOVES NOCKS
- COMFORTABLE GRIP

GREEN/GREY  
15840 / 6 PK / 026509045946



#### NEWTON DIGITAL BOW SCALE

- SCALE MAXIMUM: 220LBS
- DIGITAL READOUT FOR EASY USE
- PEAK WEIGHT SETTING

GREY  
15836 / 3 PK / 026509045977



#### ENERGY FLETCH REMOVER

- WORKS ON MULTIPLE SHAFTS
- REPLACEABLE BLADES INCLUDED
- REMOVES ARROW FLETCHING

GREY  
6960 / 6 PK / 026509069607



#### BROADHEAD WRENCH

- 2, 3 AND 4-BLADE BROADHEADS
- FITS MOST FIXED & EXPANDABLE BLADE BROADHEADS

BLACK  
66 / 6 PK / 026509000662



#### FORCE ARROW PULLER

- EASY PULLING FORCE
- MOLDED FINGER GROOVES

GREY  
151 / 6 PK / 026509001515

OLIVE GREEN  
162 / 6 PK / 026509001621



#### 10-IN-1 MULTI-WRENCH

- WORKS ON MOST COMPOUND BOWS
- INCLUDES LARGE RANGE OF ALLEN WRENCH SIZES

BLACK  
15990 / 6 PK / 026509159902





**PRODUCTS DESIGNED  
WITH UNIQUE FEATURES  
TO HELP CALM YOUR  
PRIMAL SENSES**

**RIGOR COMPACT  
CALIPER RELEASE**

- FACTORY TUNED TRIGGER
- 360° ROTATING CALIPER HEAD
- ADJUSTABLE WRIST STRAP
- FOR BOWS UP TO 80Lbs

BLACK  
15320 / 6 PK /  
026509153207



**RIGOR ADULT  
CALIPER RELEASE**

- FACTORY TUNED TRIGGER
- 360° ROTATING CALIPER HEAD
- ADJUSTABLE WRIST STRAP
- FOR BOWS UP TO 80Lbs

BLACK  
153 / 6 PK /  
026509001539



**TENSION HYPALON  
WRIST SLING**

- LIGHT/STRONG HYPALON
- NO-LOOK HAND PLACEMENT
- SCENT REDUCTION BAND
- TOUGH AND RUGGED

CAMO  
6651 / 6 PK /  
026509045830



**BRAIDED  
BOW SLING**

- LIGHT/STRONG HYPALON
- BRAIDED CORD
- PREVENTS HAND TORQUE
- HEX NUT ADAPTER

CAMO  
662 / 6 PK /  
026509006626



**COMPACT THUMB  
ACTIVATED RELEASE**

- IMPROVES ACCURACY
- AUTO-LOCK
- FOR BOWS UP TO 60LBS
- AMBIDEXTROUS

BLACK  
1539 / 6 PK / 026509015390



**SUPER  
COMFORT GLOVE**

- LEATHER ROLLED FINGER TIP DESIGN
- PROTECTS FINGER TIPS
- LIGHTWEIGHT

SIZE: MEDIUM  
60325 / 6 PK / 026509603252  
SIZE: LARGE  
60335 / 6 PK / 026509603351



**PREMIUM  
NO PINCH TAB**

- SLICK STRING SURFACE
- IMPROVES ACCURACY
- LAYERED SUEDE LEATHER
- PLASTIC FINGER SPACER

SIZE: UNIVERSAL  
15003 / 6 PK / 026509150039

# RELEASES, WRIST SLINGS AND ARMGUARDS



## 4-STRAP ARMGUARD

- COMFORTABLE LINING
- ADJUSTABLE WRIST STRAPS
- LIGHTWEIGHT
- STRING-SLIDE MATERIAL
- KEEPS CLOTHING OFF BOWSTRINGS

11IN / MOSSY OAK BREAK-UP COUNTRY  
4120 / 6 PK / 026509041207



## ARTERY 3-STRAP ARMGUARD

- COMFORTABLE MATERIAL
- ADJUSTABLE WRIST STRAPS
- LIGHTWEIGHT
- KEEPS CLOTHING OFF BOWSTRINGS

REALTREE EDGE  
4313 / 6 PK / 026509045908



## 2-STRAP ARMGUARD

- COMFORTABLE MATERIAL
- ADJUSTABLE WRIST STRAPS
- LIGHTWEIGHT
- KEEPS CLOTHING OFF BOWSTRINGS

6.5IN / MOSSY OAK  
BREAK-UP COUNTRY  
4200 / 6 PK /  
026509042006



## 3-STRAP ARMGUARD

- COMFORTABLE MATERIAL
- ADJUSTABLE WRIST STRAPS
- LIGHTWEIGHT
- KEEPS CLOTHING OFF BOWSTRINGS

7IN / MOSSY OAK  
BREAK-UP COUNTRY  
4310 / 6 PK /  
026509043102



## 2-STRAP MESH ARMGUARD

- COMFORTABLE MATERIAL
- ADJUSTABLE WRIST STRAPS
- LIGHTWEIGHT
- KEEPS CLOTHING OFF BOWSTRINGS

GREEN  
42014 / 6 PK / 026509420149

ORANGE  
42016 / 6 PK / 026509420163



# STORAGE SYSTEMS FOR THE ULTIMATE FISHING EXPERIENCE

**2-IN-1**  
BACKPACK AND WAIST PACK COMBO

**SMALL BACKPACK:**  
1,350cu in (22L)

**WAIST PACK:**  
540cu in (8L)



**NEW**

## FRYPAN RIVER CONVERTIBLE FISHING PACK

- 2-IN-1 FISHING PACK
- PACK CAN ZIP APART TO CREATE A SMALLER BACKPACK & FANNY PACK TO BE WORN SEPARATELY OR TOGETHER
- FITS MULTIPLE STORAGE & TACKLE BOXES
- SIDE STRAPS ADJUST FOR ACCESSIBILITY
- FLAP FOLDS DOWN FOR USE AS A WORKSTATION
- SIDE POCKETS FOR WATER BOTTLES OR ROD TUBES
- PADDED SHOULDER BACKPACK STRAPS
- BOTTLE OPENER & D-RINGS

GRAY/LIME  
 FULL BACKPACK: 12"L X 7.5"W X 21"H (30 LITERS)  
 SMALLER PACK: 12"L X 7.5"W X 15"H (22 LITERS)  
 HIP PACK: 12"L X 7.5"W X 6"H (8 LITERS)

**6376 \ 3 PK \ 026509061014**



**NEW**

## CHATFIELD COMPACT FISHING BACKPACK

- FISHING TACKLE BOX BACKPACK
- FITS MULTIPLE STORAGE & TACKLE BOXES
- SIDE STRAPS ADJUST FOR ACCESSIBILITY
- SIDE POCKETS FOR WATER BOTTLES OR ROD TUBES
- FLAP FOLDS DOWN FOR USE AS A WORKSTATION
- HYDRATION COMPATIBLE
- FRONT STASH POCKET AND SIDE POCKETS
- SPANDEX MESH POUCH FOR SMALLER ACCESSORIES
- SUFFICIENT INTERIOR STORAGE
- PADDED SHOULDER BACKPACK STRAPS & D-RINGS
- AIR MESH BACK

GRAY/LIME  
 FULL BACKPACK: 12"L X 6"W X 15"H (17.6 LITERS)

**6374 \ 3 PK \ 026509060987**



**NEW**

## BLUE MESA FISHING PACK

- FISHING TACKLE BOX BACKPACK
- FITS MULTIPLE STORAGE & TACKLE BOXES
- SIDE STRAPS ADJUST FOR ACCESSIBILITY
- SIDE POCKETS FOR WATER BOTTLES OR ROD TUBES
- FLAP FOLDS DOWN FOR USE AS A WORKSTATION
- HYDRATION COMPATIBLE
- FRONT STASH POCKET AND SIDE POCKETS
- SPANDEX MESH POUCH FOR SMALLER ACCESSORIES
- SUFFICIENT INTERIOR STORAGE

GRAY/LIME  
 FULL BACKPACK: 12"L X 6"W X 20"H (23.25 LITERS)

**6375 \ 3 PK \ 026509060994**





**GUNNISON SWITCH PACK**

- CONVERTS FROM DAYPACK TO SLINGPACK
- FULL ZIP MAIN PANEL
- VERTICAL INTERIOR STORAGE POCKETS
- MULTIPLE ROD TUBE/WATER BOTTLE POCKETS
- FRONT & REAR BUCKLES FOR CHEST PACKS
- HEAVY-DUTY MOLDED ZIPPEES
- WATER RESISTANT INTERIOR POCKETS
- ADJUSTABLE STRAPS SYSTEM
- HYDRATION POCKET

GREEN

**6334 \ 4 PK \ 026509018186**



**BOULDER CREEK CHEST PACK**

- ZIP DOWN WORK STATION WITH TIPPET TENDER AND FLY PATCH
- PADDED NECK STRAP WITH NET D-RING
- EXTERIOR D-RINGS FOR ACCESSORIES
- MULTIPLE INTERIOR STORAGE POCKETS
- HOLDS UP TO 6 FLY BOXES
- HEAVY-DUTY MOLDED ZIPPEES

GREEN

**6345 \ 3 PK \ 026509063452**

**NEW**

GRAY/LIME

**6353 \ 3 PK \ 026509061038**



**BEAR CREEK MICRO CHEST PACK**

- ZIP DOWN WORK STATION WITH TIPPET TENDER & FLY PATCH
- PADDED NECK STRAP WITH NET D-RING
- EXTERIOR D-RINGS FOR ACCESSORIES
- FITS MEDIUM SIZE FLY BOX
- MULTIPLE INTERIOR STORAGE POCKETS
- HEAVY-DUTY MOLDED ZIPPEES

GREEN

**6336 \ 3 PK \ 026509063360**

**NEW**

GRAY/LIME

**6377 \ 3 PK \ 026509061021**



**FALL RIVER CHEST PACK**

- ZIP DOWN WORK STATION WITH TIPPET TENDER AND FLY PATCH
- PADDED NECK STRAP WITH NET D-RING
- EXTERIOR D-RINGS FOR ACCESSORIES
- FITS LARGE SIZE FLY BOX
- MULTIPLE INTERIOR STORAGE POCKETS
- HEAVY-DUTY MOLDED ZIPPEES

GREEN

**6344 \ 3 PK \ 026509063445**

**NEW**

GRAY/LIME

**6372 \ 3 PK \ 026509061090**



**EAGLE RIVER LUMBAR PACK**

- WIDE MOUTH OPENING ACCESS TO MAIN COMPARTMENT
- ZIP DOWN WORK STATION WITH TIPPET TENDER AND FLY PATCH
- PADDED SLING STRAP WITH NET D-RING
- EXTERIOR D-RINGS FOR ACCESSORIES
- MULTIPLE INTERIOR STORAGE POCKETS
- HOLDS UP TO 6 FLY BOXES OR TWO 9IN TACKLE BOXES
- HEAVY-DUTY MOLDED ZIPPERS
- PADDED COOL MESH WAIST BELT
- TWO WATER BOTTLE POCKETS
- DUAL SIDE POCKETS FOR ACCESSORIES OR FLY BOXES

GREEN

6332 \ 3 PK \ 026509063322

**NEW**

GRAY/LIME

6378 \ 3 PK \ 026509061045



**PURPOSE BUILT  
STORAGE FOR  
FISHING GEAR**



**CEDAR CREEK SLING PACK**

- SHOULDER STRAP ORGANIZER KEEPS ESSENTIALS IN THE FRONT
- WIDE-MOUTH OPENING ALLOWS EASY ACCESS TO MAIN COMPARTMENT
- ZIP-DOWN WORK STATION WITH TIPPET TENDER AND FLY PATCH
- PADDED SLING STRAP
- MULTIPLE D-RINGS FOR ACCESSORIES

GREEN

6338 \ 3 PK \ 026509008408

**NEW**

GRAY/LIME

6362 \ 3 PK \ 026509061069





**GALLATIN  
ULTRA LIGHT  
FISHING VEST**

- LIGHTWEIGHT DESIGN
- MAXIMUM STORAGE CAPACITY
- PADDED NECK STRAP WITH NET D-RING
- ONE SIZE FITS MOST
- ZIP CLOSE FRONT POCKETS FOR LARGE FLY BOXES
- LARGE INTERIOR STRETCH MESH POCKETS
- MULTIPLE EXTERIOR STORAGE POCKETS
- HEAVY-DUTY MOLDED ZIPPERS
- EXTERIOR D-RINGS FOR ACCESSORIES

GREEN

6347 \ 3 PK \ 026509063476

**NEW**

GRAY/LIME

6370 \ 3 PK / 026509061083



**BIG HORN VEST**

- ULTIMATE HIGH CAPACITY VEST PACK
- MULTIPLE INTERIOR AND EXTERIOR STORAGE POCKETS
- ADJUSTABLE PADDED SHOULDER AND WAIST STRAP FITS MOST
- HYDRATION COMPATIBLE REAR MESH STORAGE POCKET
- DUAL FRONT ZIP DOWN WORK STATIONS WITH FLY PATCHES
- EXTERIOR D-RINGS FOR ACCESSORIES
- HIGH-VIZ LINING
- MOLLE WEB GEAR LASH AND HEMOSTAT DOCKING STATION

6346 \ 3 PK \ 026509063469



# PROTECT & TRANSPORT



## RIPRAP ROD CASE

- CLEAR I.D. WINDOW
- EASY CARRY PADDED HANDLE
- PADDED HIGH-VIZ LINED REEL COMPARTMENT
- HANGING LOOP FOR STORAGE

GREEN  
 45IN FITS 2PC SPIN RODS UP TO 7.5FT (114.3CM, 2.3M)  
 FITS 4PC SPEY/SWITCH RODS UP TO 13FT (13.9M)

**1660 \ 4 PK \ 026509016601**

**NEW**

GRAY/LIME  
 45IN FITS 2PC SPIN RODS UP TO 7.5FT (114.3CM, 2.3M)  
 FITS 4PC SPEY/SWITCH RODS UP TO 13FT (13.9M)

**6363 \ 4 PK \ 026509061076**



## COTTONWOOD ROD AND GEAR BAG

- FITS UP TO FOUR 4-PIECE 9.5FT RODS
- MULTIPLE INTERIOR SEE-THROUGH ZIPPERED STORAGE POCKETS
- EIGHT INTERIOR ADJUSTABLE DIVIDERS FOR RODS, REELS AND OTHER GEAR
- NON-SLIP WEAR RESISTANT BOTTOM
- REMOVABLE PADDED SHOULDER STRAP

GREEN  
 30.5IN X 8.75IN X 3.75IN (77.4CM X 24.7CM X 9.5CM)

**6369 \ 1 PK \ 026509063698**

**NEW**

GRAY/LIME  
 30.5IN X 8.75IN X 3.75IN (77.4CM X 24.7CM X 9.5CM)

**6379 \ 1 PK \ 026509061052**





**PLATTE RIVER GEAR BAG**

- LARGE CAPACITY STORAGE AREA FOR GEAR, TACKLE BOXES
- HEAVY DUTY PADDED CARRY HANDLE
- BUILT IN ROD TUBE STRAPS
- MULTIPLE INTERIOR AND EXTERIOR STORAGE POCKETS
- HIGH-VIZ LINING
- HEAVY-DUTY MOLDED ZIPPERS
- REMOVABLE PADDED SHOULDER STRAP
- INTERNAL DIMENSIONS: 17IN X 10.5IN X 11IN (43.1CM X 26.6CM X 28CM)

GREEN

**6359 \ 2 PK \ 026509063599**



**SPRING CREEK REEL AND GEAR BAG**

- FITS UP TO 10 FLY REELS AND SPOOLS OR 6 SPINNING REELS
- 8 INTERIOR ADJUSTABLE DIVIDERS
- INTERIOR SEE-THROUGH ZIPPED STORAGE POCKETS
- HIGH-VIZ LINING
- HEAVY-DUTY MOLDED ZIPPERS

GREEN

10.5IN X 8.75IN (26.6CM X 22.2CM X 9.5CM)

**6357 \ 2 PK \ 026509063575**



## TWIN CREEK WADER BAG

- SPLIT DESIGN STORES WADERS AND BOOTS SEPARATELY
- MESH WINDOWS SPEED DRYING
- STORAGE POCKET FOR EXTRA LACES, REPAIR KIT OR SOCKS
- HIGH-VIZ LINING
- HEAVY-DUTY MOLDED ZIPPERS
- INTERNAL DIMENSIONS: \

13IN X 12IN X 12IN (33CM X 30.4CM X 30.4CM)

**6366 \ 3 PK \ 026509063667**





### GRANITE RIVER WADING BOOTS

- FELT SOLE FOR INCREASED TRACTION
- SPEED LACED UPPER FOR QUICK ON AND OFF
- DURABLE TOE AND HEEL BOX
- LIGHTWEIGHT EVA MIDSOLE CONSTRUCTION
- PADDED TONGUE AND COLLAR
- PULL-ON HEEL STRAP

**3 PK**  
 15746 \ 6 \ 026509157465  
 15747 \ 7 \ 026509157472  
 15748 \ 8 \ 026509157489  
 15749 \ 9 \ 026509157496  
 15740 \ 10 \ 026509157403  
 15741 \ 11 \ 026509157410  
 15742 \ 12 \ 026509157427  
 15743 \ 13 \ 026509157434



### BOOT HANGER

- ACCELERATED DRYING TIME OF WET FOOTWEAR
- IDEAL FOR HANGING WADERS AND BOOTS
- MADE FROM HIGH IMPACT PLASTIC

10512 \ 6 PK \ 026509105121

**WALK WITH  
CONFIDENCE**



**PLATTE PRO BREATHABLE STOCKINGFOOT WADER**

- DUPONT® TEFLON™ DWR FABRIC PROTECTOR
- ULTRA-FRESH ANTIMICROBIAL TREATMENT
- ADVANCED MPT MICRO PORE TECHNOLOGY
- 2-TONE ARTICULATED KNEES
- PADDED AIR MESH SHOULDER STRAPS
- HIGH DENSITY NEOPRENE DOUBLE TAPED BOOTIES

**3 PK - GREY**

SHOE SIZE: 5.6-5 | CHEST: 42-INCHES | INSEAM: 32-INCHES  
**18161 \ S \ 026509181613**

SHOE SIZE: 6.5-9.5 | CHEST: 45-INCH | INSEAM: 34-INCH  
**18162 \ M \ 026509181620**

SHOE SIZE: 9.5-11 | CHEST: 48-INCH | INSEAM: 36-INCH  
**18163 \ L \ 026509181637**

SHOE SIZE: 11 - 12.5 | CHEST: 51-INCHES | INSEAM: 38-INCHES  
**18164 \ XL \ 026509181644**

SHOE SIZE: 12.5 - 14 | CHEST: 54-INCH | INSEAM: 38-INCH  
**18165 \ XXL \ 026509181651**



**ROCK CREEK STOCKINGFOOT NEOPRENE WADER**

- OVERSIZED HAND WARMER AND STORAGE POCKET
- ADJUSTABLEWEB SUSPENDERS WITH FRONT D-RINGS
  - 3.5MM NEOPRENE CONSTRUCTION
  - HIGH BACK DESIGN
  - REINFORCED KNEE PADS
  - WEB WAIST BELT INCLUDED

**3 PK**

**12861 \ S \ 026509128618**

**12862 \ M \ 026509128625**

**12863 \ LG \ 026509128632**

**12864 \ XL \ 026509128649**

**12865 \ XXL \ 026509128656**



**BLACK RIVER  
HIP WADER**

- CLEFT SOLES
- INTEGRATED BELT LOOP
- TAKE-UP STRAP
- MADE FROM RUGGED NYLON
- TWO-PLY UPPER FABRIC

**3 PK**

**11767 \ 7 \ 026509117674**

**11768 \ 8 \ 026509117681**

**11769 \ 9 \ 026509117698**

**11760 \ 10 \ 026509117605**

**11761 \ 11 \ 026509117612**

**11762 \ 12 \ 026509117629**

**11763 \ 13 \ 026509117636**

**STOCKINGFOOT WADERS**

**NEOPRENE**

SIZE	CHEST	INSEAM	U.S. SHOE	EU SHOE
SMALL	38IN (97CM)	29IN (73CM)	5-6.5	4.5-5.5
MEDIUM	40IN (101CM)	30.5IN (77CM)	6.5-9.5	6-9
LARGE	42IN (106CM)	32IN (82CM)	9.5-11	9-10.5
X-LARGE	44IN (111CM)	33.5IN (84CM)	11-12.5	10.5-12
XX-LARGE	45IN (114CM)	35IN (89CM)	12.5-14	12-13
M/KING	42IN (106CM)	30.5IN (77CM)	6.5-9.5	6-9
L/KING	44IN (111CM)	32IN (81CM)	9.5-11	9-10.5
XL/KING	47IN (119CM)	33.5IN (84CM)	11-12.5	10.5-12

**STOCKINGFOOT WADERS**

**BREATHABLE**

SIZE	CHEST	INSEAM	SHOE	EU SHOE
X-SMALL	39IN (99CM)	30IN (76CM)	4-5.5	3.5-5
SMALL	42IN (106CM)	32IN (81CM)	5-6.5	4.5-6
MEDIUM	45IN (114CM)	34IN (86CM)	6.5-9.5	6-9
LARGE	48IN (121CM)	36IN (91CM)	9.5-11	9-11.5
X-LARGE	51IN (129CM)	38IN (96CM)	11-12.5	10.5-12
2X-LARGE	54IN (137CM)	38IN (96CM)	12.5-14	12-13.5
M/KING	53IN (134CM)	36IN (91CM)	6.5-9.5	6-9
L/KING	56IN (142CM)	38IN (96CM)	9.5-11	9-10.5
XL/KING	60IN (151CM)	38IN (96CM)	11-12.5	10.5-12

**BOOTFOOT WADERS**

**RUBBER TWO-PLY**

SIZE	CHEST	INSEAM	SHOE	EU SHOE
7	50IN (127CM)	35IN (89CM)	7	6.5
8	51IN (129CM)	36IN (91CM)	8	7.5
9	52IN (132CM)	36IN (91CM)	9	8.5
10	53IN (134CM)	37IN (93CM)	10	9.5
11	55IN (139CM)	37IN (93CM)	11	10.5
12	56IN (142CM)	38IN (96CM)	12	11.5
13	56IN (142CM)	38IN (96CM)	13	12